

# NTC Thermistor: SCK Series

## Power Thermistor for Limiting Inrush Current



### ■ Features

1. RoHS & HF compliant
2. Body size:  $\Phi 5\text{mm} \sim \Phi 30\text{mm}$
3. Radial lead resin coated
4. High power rating
5. Wide resistance range
6. Cost effective
7. Operating temperature range :
  - $\Phi 5\text{mm}$  :  $-40 \sim +150^\circ\text{C}$
  - $\Phi 8 \sim \Phi 10\text{mm}$  :  $-40 \sim +170^\circ\text{C}$
  - $\Phi 13\text{mm} \sim \Phi 30\text{mm}$  :  $-40 \sim +200^\circ\text{C}$
8. Agency recognition: UL /cUL/TUV /CSA/CQC

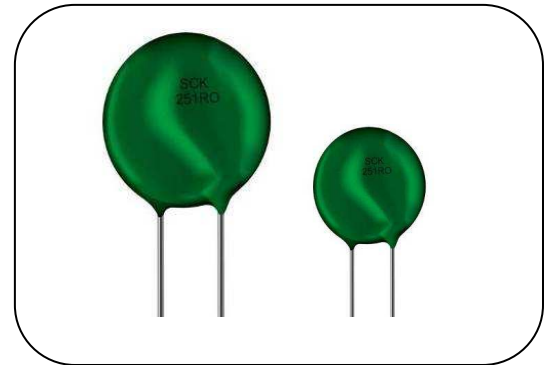

### ■ Recommended Applications

1. Switch mode power supply
2. Electric motor
3. Transformer
4. Adapter
5. Projector
6. Halogen lamp

### ■ Part Number Code

- $\Phi 5\text{mm} \sim \Phi 15\text{mm}$

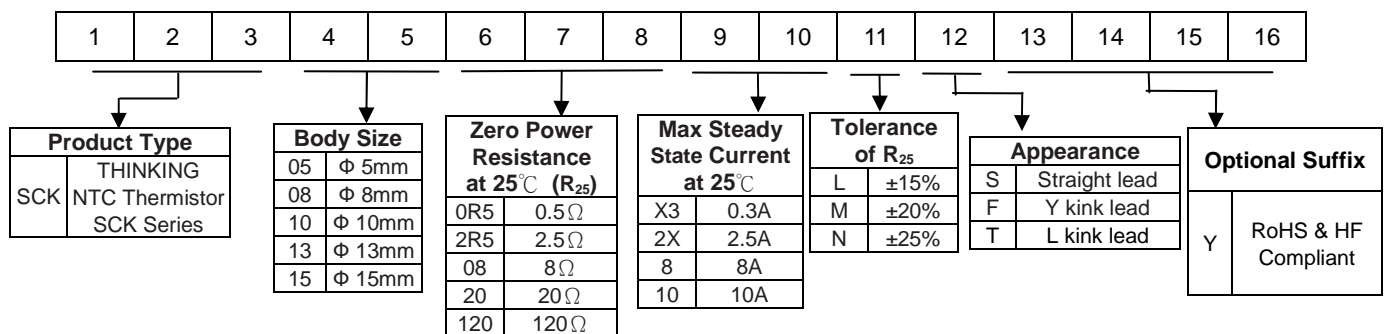

- $\Phi 20\text{mm} \sim \Phi 30\text{mm}$

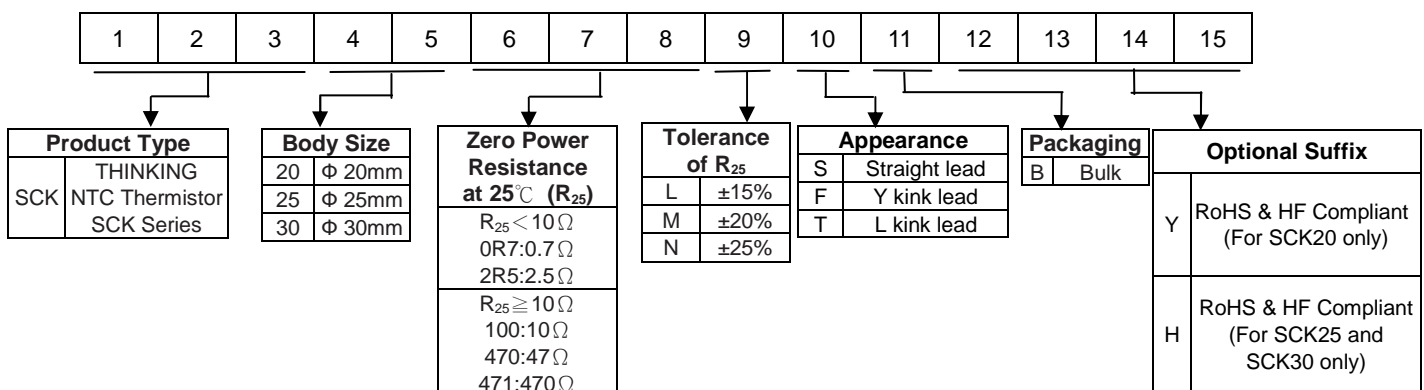

# NTC Thermistor: SCK Series

## Power Thermistor for Limiting Inrush Current



### ■ Structure and Dimensions

#### S Type (Straight lead)

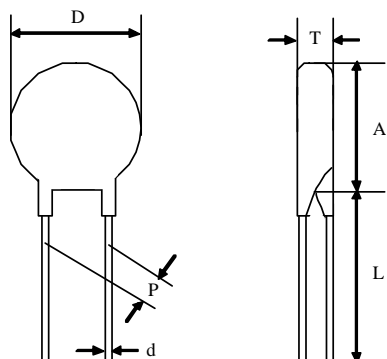

(Unit: mm)

Body Size	Dmax.	P.	d	Amax.	Lmin.	Tmax.
φ05	6.5	4±0.6	0.8±0.02	6.5	31	5
φ08	9.5	5±0.8	0.8±0.02	9.5	31	5
φ10	11.5	5±0.8	0.8±0.02	11.5	31	5
φ13	14.5	7.5±1	0.8±0.02	14.5	30	6
φ15	16.5	7.5±1	1.0±0.02	16.5	29	6
φ20	21.5	7.5±1	1.0±0.02	21.5	26	6
φ25	29	7.5±1	1.0±0.02	29	25	7
φ30	36	7.5±1	1.0±0.02	36	23	8

#### F Type (Y kink lead)

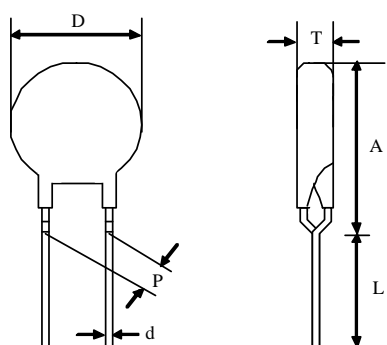

(Unit: mm)

Body Size	Dmax.	P	d	Amax.	Lmin.	Tmax.
φ05	6.5	4±0.6	0.8±0.02	11	29	5
φ08	9.5	5±0.8	0.8±0.02	13	29	5
φ10	11.5	5±0.8	0.8±0.02	15	29	5
φ13	14.5	7.5±1	0.8±0.02	17.5	27	6
φ15	16.5	7.5±1	1±0.02	19	26	6
φ20	21.5	7.5±1	1±0.02	24.5	25	6
φ25	29	7.5±1	1±0.02	35	22	7
φ30	36	7.5±1	1±0.02	42	22	8

#### T Type (L kink lead)

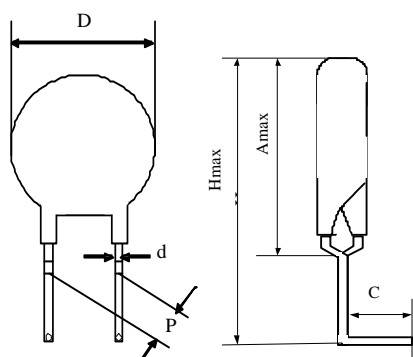

(Unit: mm)

Body Size	Dmax.	P	d	Amax.	Hmax.	C.	Tmax.
φ05	6.5	4±0.6	0.8±0.02	11	15.5	4.0±1	5
φ08	9.5	5±0.8	0.8±0.02	13	17.5	4.0±1	5
φ10	11.5	5±0.8	0.8±0.02	15	19.5	4.0±1	5
φ13	14.5	7.5±1	0.8±0.02	17.5	21.5	4.0±1	6
φ15	16.5	7.5±1	1±0.02	19	23.5	4.0±1	6
φ20	21.5	7.5±1	1±0.02	24.5	28.5	4.0±1	6

# NTC Thermistor: SCK Series

## Power Thermistor for Limiting Inrush Current



### ■ Electrical Characteristics

Part No.	Zero Power Resistance at 25°C	Max. Current at 25°C	Residual Resistance at 25°C I <sub>max</sub>	Max. Power Rating at 25°C	Dissipation Factor	Thermal Time Constant	Operating Temperature Range	Safety Approvals				
	R <sub>25</sub> (Ω)	I <sub>max</sub> (A)	R <sub>I<sub>max</sub></sub> (Ω)	P <sub>max</sub> (W)	δ (mW/°C)	τ(Sec.)	T <sub>L</sub> ~T <sub>U</sub> (°C)	UL	cUL	CSA	TUV	CQC
SCK05052□	5	2	0.429	1.8	Approx. 15	Approx. 17	-40 ~ +150	√	√	√	√	√
SCK05081□	8	1	1.089					√	√		√	√
SCK05101□	10	1	1.126					√	√	√	√	√
SCK05121□	12	1	1.184					√	√		√	√
SCK0520X3□	20	0.3	5.560					√	√	√	√	√
SCK08042□	4	2	0.441	2.3	Approx. 16	Approx. 38	-40 ~ +170	√	√	√	√	√
SCK084R72□	4.7	2	0.445					√	√	√	√	√
SCK08053□	5	3	0.261					√	√	√	√	√
SCK08063□	6	3	0.283					√	√	√	√	√
SCK08073□	7	3	0.287					√	√		√	√
SCK08082□	8	2	0.520					√	√	√	√	√
SCK08102□	10	2	0.542					√	√	√	√	√
SCK08152□	15	2	0.548					√	√	√	√	√
SCK08201□	20	1	1.544					√	√	√	√	√
SCK0830X□	30	0.5	4.094					√	√	√	√	√
SCK10015□	1	5	0.091	2.4	Approx. 17	Approx. 43	-40 ~ +170	√	√		√	√
SCK101R35□	1.3	5	0.095					√	√		√	√
SCK101R55□	1.5	5	0.101					√	√		√	√
SCK102R55A□	2.5	5	0.120					√	√	√	√	√
SCK10035□	3	5	0.127					√	√	√	√	√
SCK10044□	4	4	0.161					√	√	√	√	√
SCK10054□	5	4	0.180					√	√	√	√	√
SCK106R83□	6.8	3	0.270					√	√	√	√	√
SCK10083□	8	3	0.278					√	√	√	√	√
SCK10103□	10	3	0.297					√	√	√	√	√
SCK10123□	12	3	0.301					√	√	√	√	√
SCK10133□	13	3	0.356					√	√	√	√	√
SCK10152X□	15	2.5	0.442					√	√	√	√	√
SCK10162X□	16	2.5	0.471					√	√	√	√	√
SCK10202□	20	2	0.646					√	√	√	√	√
SCK10222□	22	2	0.659					√	√		√	√
SCK10252□	25	2	0.674					√	√	√	√	√
SCK10302□	30	2	0.700					√	√	√	√	√
SCK10472□	47	2	0.720					√	√	√	√	√
SCK10502□	50	2	0.813					√	√	√	√	√
SCK10801□	80	1	2.236	√	√	√	√	√				
SCK101001□	100	1	2.318	√	√	√	√	√				
SCK101201□	120	1	2.406	√	√	√	√	√				

# NTC Thermistor: SCK Series

## Power Thermistor for Limiting Inrush Current



Part No.	Zero Power Resistance at 25°C	Max. Current at 25°C	Residual Resistance at 25°C I <sub>max</sub>	Max. Power Rating at 25°C	Dissipation Factor	Thermal Time Constant	Operating Temperature Range	Safety Approvals				
	R <sub>25</sub> (Ω)	I <sub>max</sub> (A)	R <sub>I<sub>max</sub></sub> (Ω)	P <sub>max</sub> (W)	δ(mW/°C)	τ(Sec.)	T <sub>L</sub> ~T <sub>U</sub> (°C)	UL	cUL	CSA	TUV	CQC
SCK13013□	1	3	0.174	3.1	Approx. 18	Approx. 66	-40 ~ +200	√	√		√	√
SCK131R37□	1.3	7	0.070					√	√		√	√
SCK132R56□	2.5	6	0.094					√	√	√	√	√
SCK13045□	4	5	0.132					√	√		√	√
SCK134R74□	4.7	4	0.168					√	√		√	√
SCK13055□	5	5	0.166					√	√	√	√	√
SCK13074□	7	4	0.184					√	√		√	√
SCK13084□	8	4	0.206					√	√	√	√	√
SCK13104□	10	4	0.217					√	√	√	√	√
SCK13124□	12	4	0.230					√	√	√	√	√
SCK13153□	15	3	0.343					√	√	√	√	√
SCK13163□	16	3	0.348					√	√	√	√	√
SCK13183□	18	3	0.365					√	√	√	√	√
SCK13203□	20	3	0.410					√	√	√	√	√
SCK150R78A□	0.7	8	0.051	3.6	Approx. 21	Approx. 75	-40 ~ +200	√	√		√	√
SCK15018□	1	8	0.054					√	√		√	
SCK151R38□	1.3	8	0.064					√	√	√	√	√
SCK151R58□	1.5	8	0.068					√	√	√	√	√
SCK15028□	2	8	0.078					√	√		√	√
SCK152R58□	2.5	8	0.086					√	√	√	√	√
SCK15037□	3	7	0.091					√	√	√	√	√
SCK15046□	4	6	0.117					√	√	√	√	√
SCK15056□	5	6	0.121					√	√	√	√	√
SCK15065□	6	5	0.159					√	√	√	√	√
SCK15075□	7	5	0.161					√	√	√	√	√
SCK15085□	8	5	0.165					√	√		√	√
SCK15105□	10	5	0.178					√	√	√	√	√
SCK15125□	12	5	0.185					√	√	√	√	√
SCK15154□	15	4	0.261					√	√	√	√	√
SCK15164□	16	4	0.265					√	√	√	√	√
SCK15184□	18	4	0.273					√	√	√	√	√
SCK15204□	20	4	0.283					√	√	√	√	√
SCK15224□	22	4	0.308					√	√		√	√
SCK15253□	25	3	0.425					√	√	√	√	√
SCK15303□	30	3	0.461					√	√	√	√	√
SCK15333□	33	3	0.484					√	√		√	√
SCK15403□	40	3	0.511					√	√	√	√	√
SCK15473□	47	3	0.517					√	√	√	√	√
SCK15802X□	80	2.5	0.693	√	√	√	√	√				
SCK151202□	120	2	1.010	√	√	√	√	√				

# NTC Thermistor: SCK Series

## Power Thermistor for Limiting Inrush Current



Part No.	Zero Power Resistance at 25°C	Max. Current at 25°C	Residual Resistance at 25°C I <sub>max</sub>	Max. Power Rating at 25°C	Dissipation Factor	Thermal Time Constant	Operating Temperature Range	Safety Approvals				
	R <sub>25</sub> (Ω)	I <sub>max</sub> (A)	R <sub>I<sub>max</sub></sub> (Ω)	P <sub>max</sub> (W)	δ(mW/°C)	τ(Sec.)	T <sub>L</sub> ~T <sub>U</sub> (°C)	UL	cUL	CSA	TUV	CQC
SCK200R7□	0.7	15	0.035	4.9	Approx. 28	Approx. 113	-40 ~ +200	√	√		√	√
SCK201R0□	1	13	0.034					√	√		√	√
SCK201R5□	1.5	10.5	0.041					√	√		√	√
SCK202R0□	2	10	0.062					√	√		√	√
SCK202R5□	2.5	9	0.083					√	√		√	√
SCK203R0□	3	8.5	0.078					√	√		√	√
SCK204R0□	4	8	0.080					√	√		√	√
SCK204R7□	4.7	7.5	0.114					√	√		√	√
SCK205R0□	5	7.5	0.118					√	√		√	√
SCK206R0□	6	7	0.120					√	√		√	√
SCK206R8□	6.8	6.5	0.130					√	√		√	√
SCK207R0□	7	6.5	0.132					√	√		√	√
SCK208R0□	8	6	0.161					√	√		√	√
SCK20100□	10	5.5	0.196					√	√		√	√
SCK20120□	12	5	0.197					√	√		√	√
SCK20130□	13	5	0.213					√	√		√	√
SCK20150□	15	4.5	0.258					√	√		√	√
SCK20160□	16	4.5	0.276					√	√		√	√
SCK20180□	18	4	0.280					√	√		√	√
SCK20200□	20	4	0.306					√	√		√	√
SCK251R0□	1	20	0.020	7.0	Approx. 30	Approx. 130	-40 ~ +200	√	√		√	√
SCK251R5□	1.5	18.5	0.023					√	√		√	√
SCK252R0□	2	18	0.025					√	√		√	√
SCK252R5□	2.5	15	0.032					√	√		√	√
SCK253R0□	3	14.5	0.042					√	√		√	√
SCK254R0□	4	14	0.044					√	√		√	√
SCK254R7□	4.7	13	0.052					√	√		√	√
SCK255R0□	5	12	0.061					√	√		√	√
SCK256R8□	6.8	10.5	0.082					√	√		√	√
SCK257R0□	7	10	0.092					√	√		√	√
SCK258R0□	8	9	0.115					√	√		√	√
SCK25100□	10	8	0.141					√	√		√	√
SCK25120□	12	7.5	0.164					√	√		√	√
SCK25150□	15	6.5	0.210					√	√		√	√
SCK25180□	18	5.5	0.231					√	√		√	√
SCK25200□	20	5	0.270					√	√		√	√

# NTC Thermistor: SCK Series

## Power Thermistor for Limiting Inrush Current



Part No.	Zero Power Resistance at 25°C	Max. Current at 25°C	Residual Resistance at 25°C I <sub>max</sub>	Max. Power Rating at 25°C	Dissipation Factor	Thermal Time Constant	Operating Temperature Range	Safety Approvals				
	R <sub>25</sub> (Ω)	I <sub>max</sub> (A)	R <sub>I<sub>max</sub></sub> (Ω)	P <sub>max</sub> (W)	δ(mW/°C)	τ(Sec.)	T <sub>L</sub> ~T <sub>U</sub> (°C)	UL	cUL	CSA	TUV	CQC
SCK301R0□	1	30	0.016	8.0	Approx. 40	Approx. 190	-40 ~ +200	√	√		√	√
SCK301R5□	1.5	25	0.020					√	√		√	√
SCK302R0□	2	23	0.022					√	√		√	√
SCK302R5□	2.5	18	0.030					√	√		√	√
SCK303R0□	3	17	0.035					√	√		√	√
SCK304R0□	4	16	0.048					√	√		√	√
SCK304R7□	4.7	15	0.055					√	√		√	√
SCK305R0□	5	14	0.057					√	√		√	√
SCK306R8□	6.8	12	0.077					√	√		√	√
SCK307R0□	7	11.5	0.084					√	√		√	√
SCK308R0□	8	10.5	0.100					√	√		√	√
SCK30100□	10	10	0.115					√	√		√	√
SCK30120□	12	9	0.142					√	√		√	√
SCK30150□	15	8	0.175					√	√		√	√
SCK30180□	18	7	0.210					√	√		√	√
SCK30200□	20	6	0.233					√	√		√	√

Note1 : □ = Tolerance of R<sub>25</sub>

Note2: UL&cUL File No. E138827

CSA File No. 97495

TUV File No. R 50050155

CQC File No. CQC05001011984,985, 988,989 ,990,993

CQC04001011942, 943, 944, 963, 964, 965

# NTC Thermistor: SCK Series

## Power Thermistor for Limiting Inrush Current



### Max. Current Derating Curve

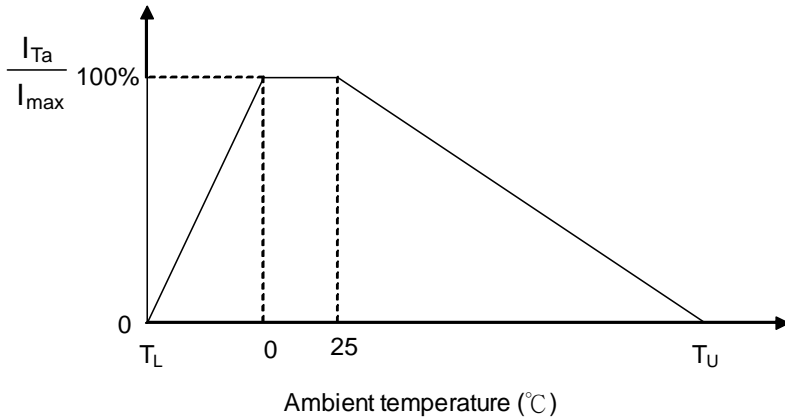

$T_U$ : Maximum operating temperature (°C)

$T_L$ : Minimum operating temperature (°C)

For example :

Ambient temperature( $T_a$ )=60°C

Maximum operating temperature( $T_U$ )=200°C

$$I_{Ta} = [1 - (T_a - 25) / (T_U - 25)] \times I_{max} = 80\% I_{max}$$

### R-T Characteristic Curves (representative)

**SCK05052~SCK0520X3**

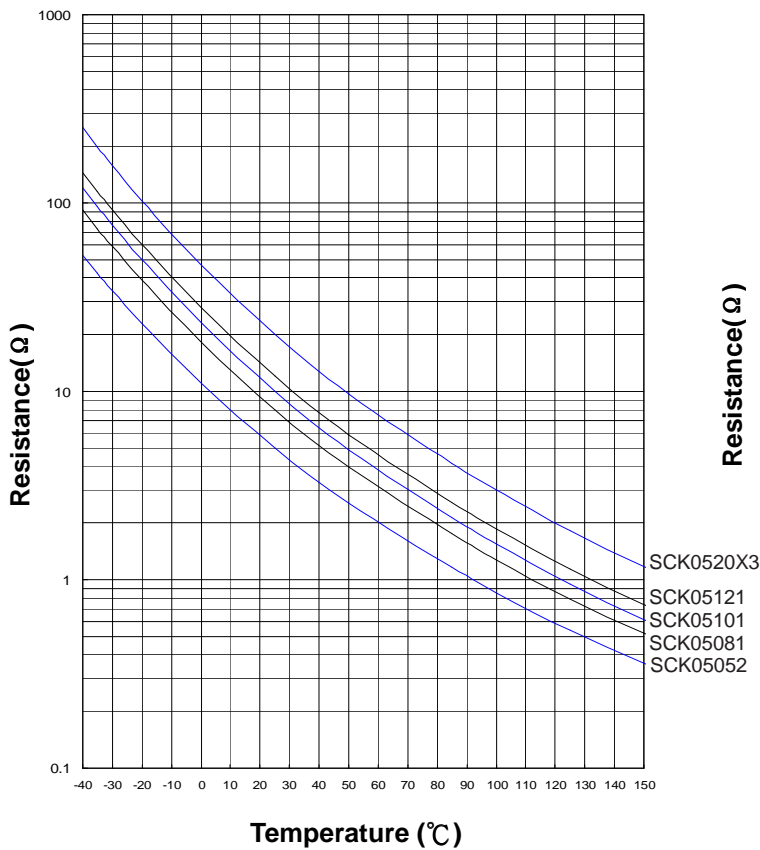

**SCK08042~SCK0830X**

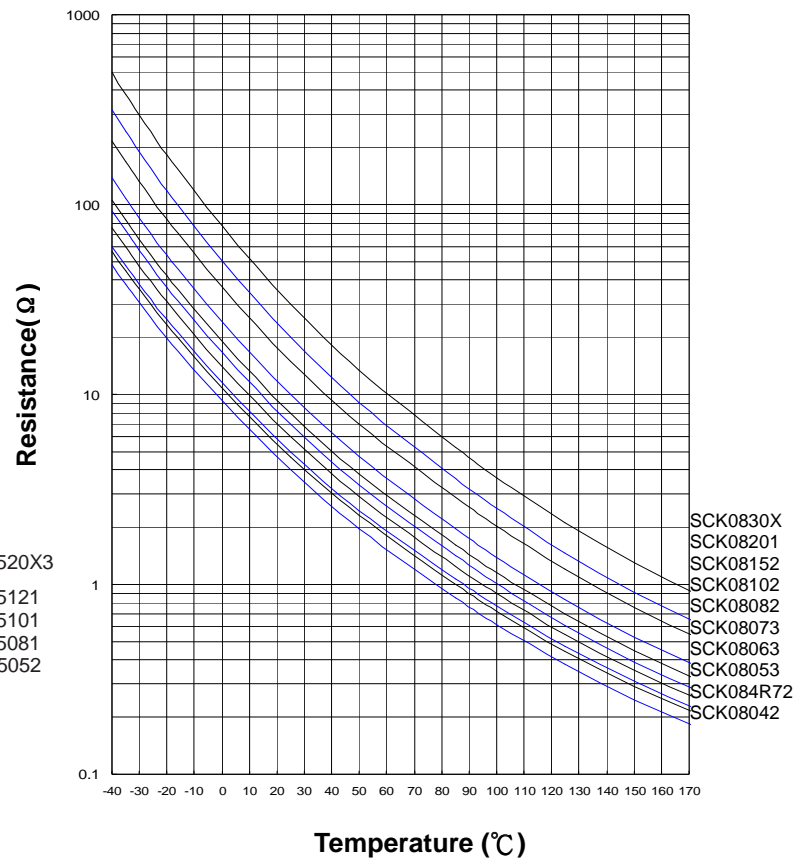

# NTC Thermistor: SCK Series

## Power Thermistor for Limiting Inrush Current



### ■ R-T Characteristic Curves (representative)

**SCK10015~SCK101201**

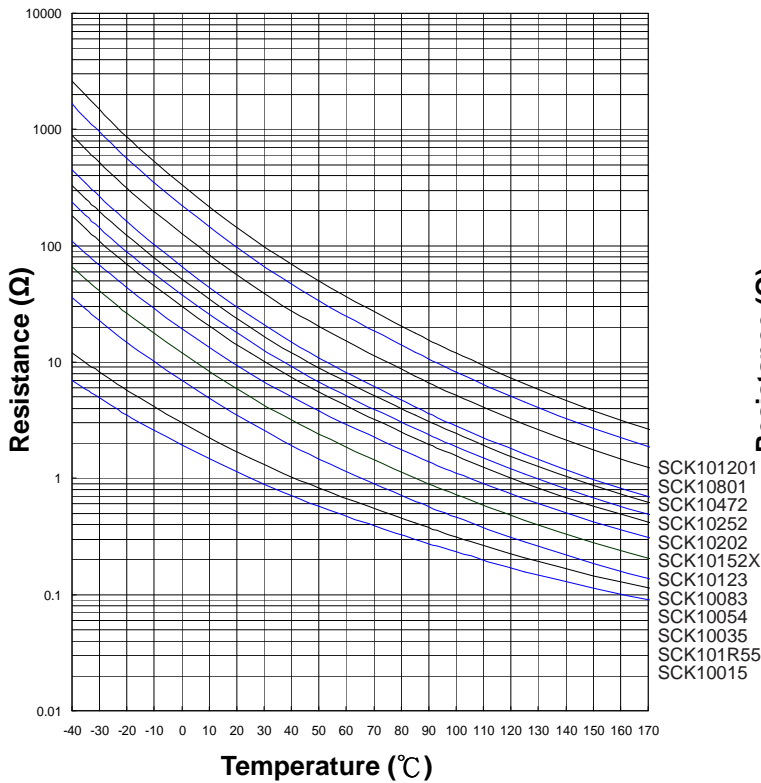

**SCK101R35~SCK101001**

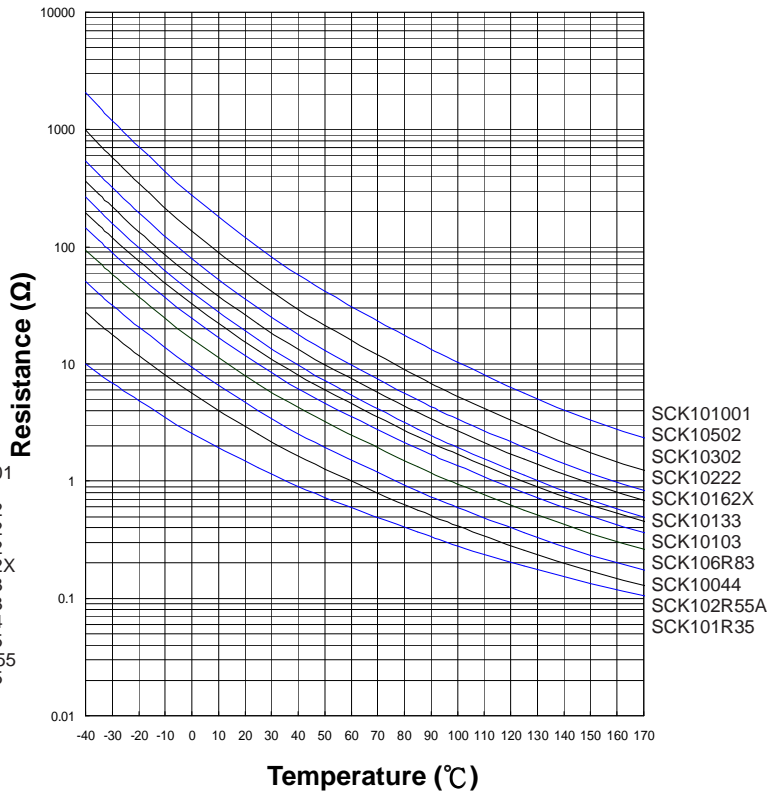

**SCK13013~SCK13183**

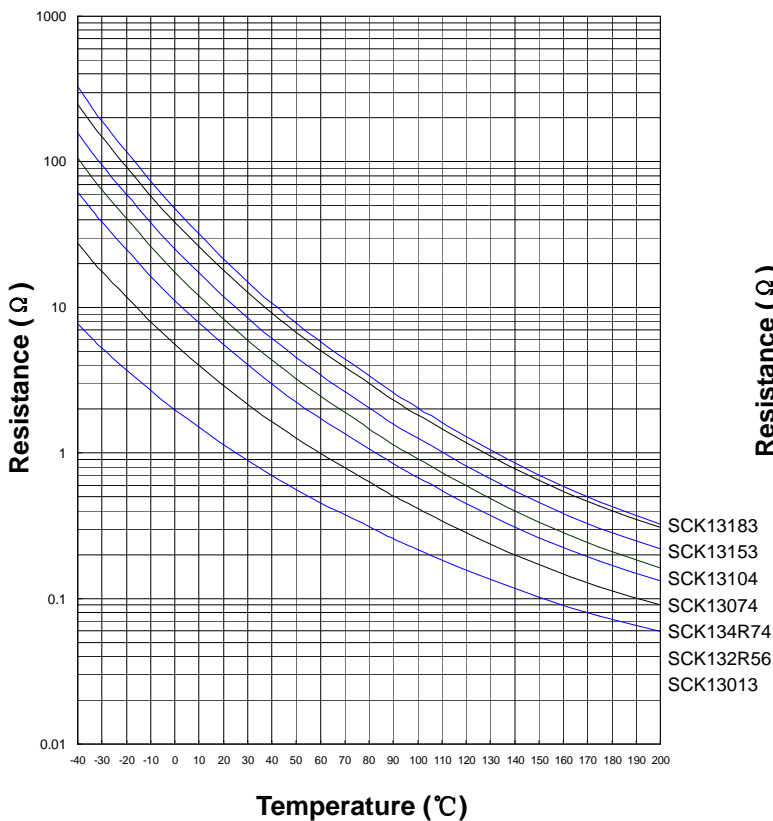

**SCK131R37~SCK13203**

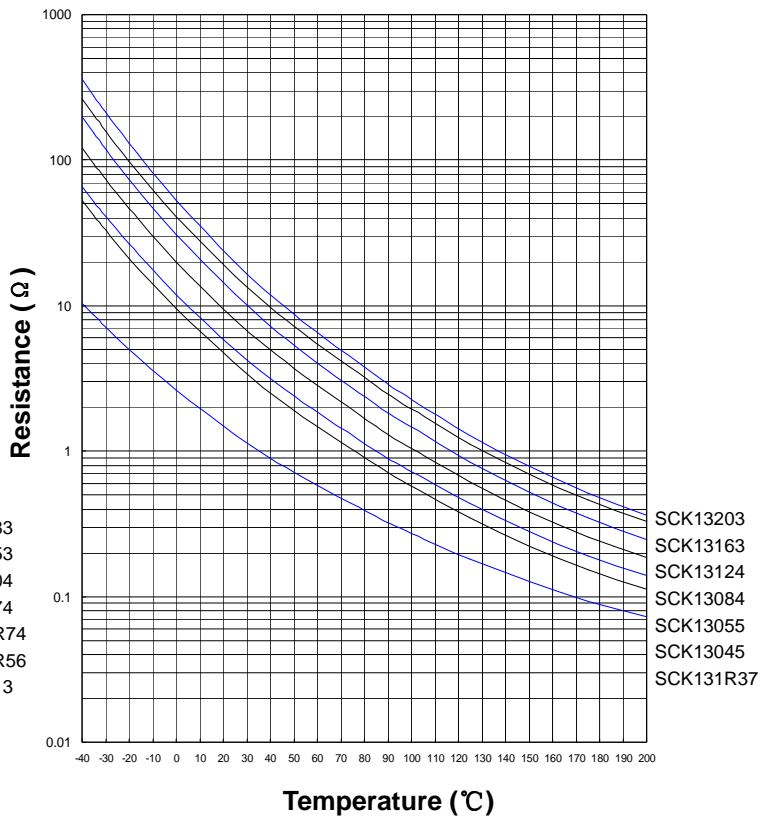



# NTC Thermistor: SCK Series

## Power Thermistor for Limiting Inrush Current



### ■ R-T Characteristic Curves (representative)

SCK150R78A~SCK151202

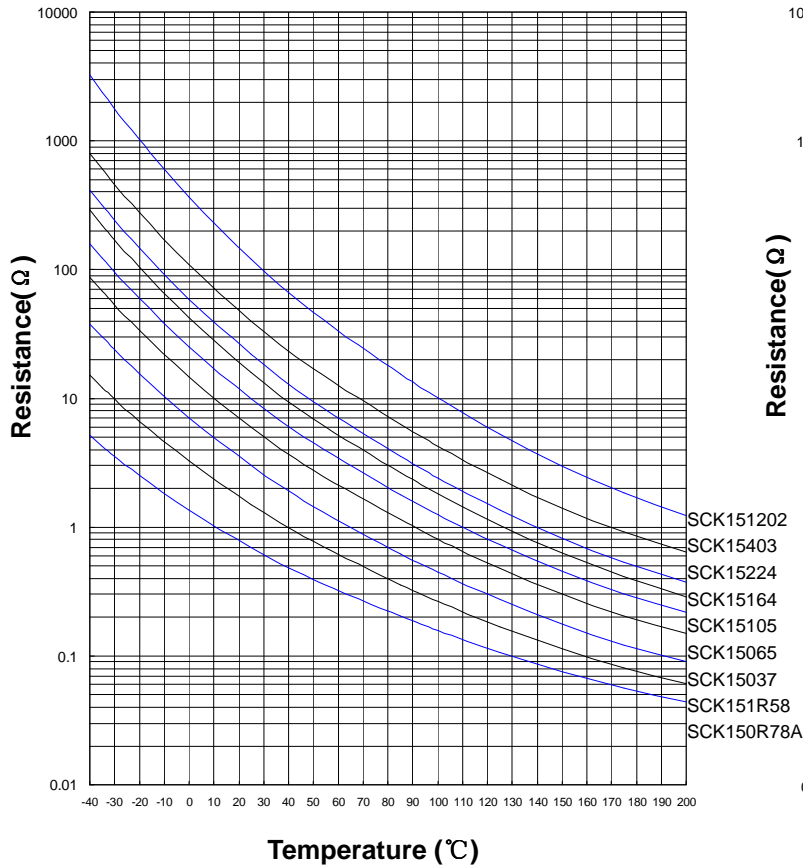

SCK15016~SCK15473

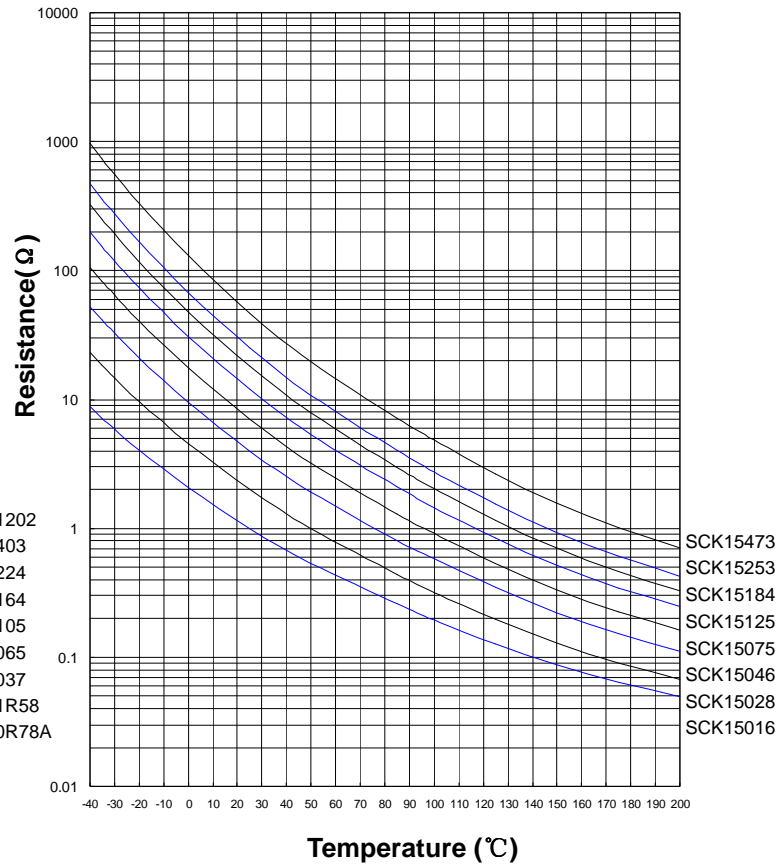

SCK151R38~SCK15802X

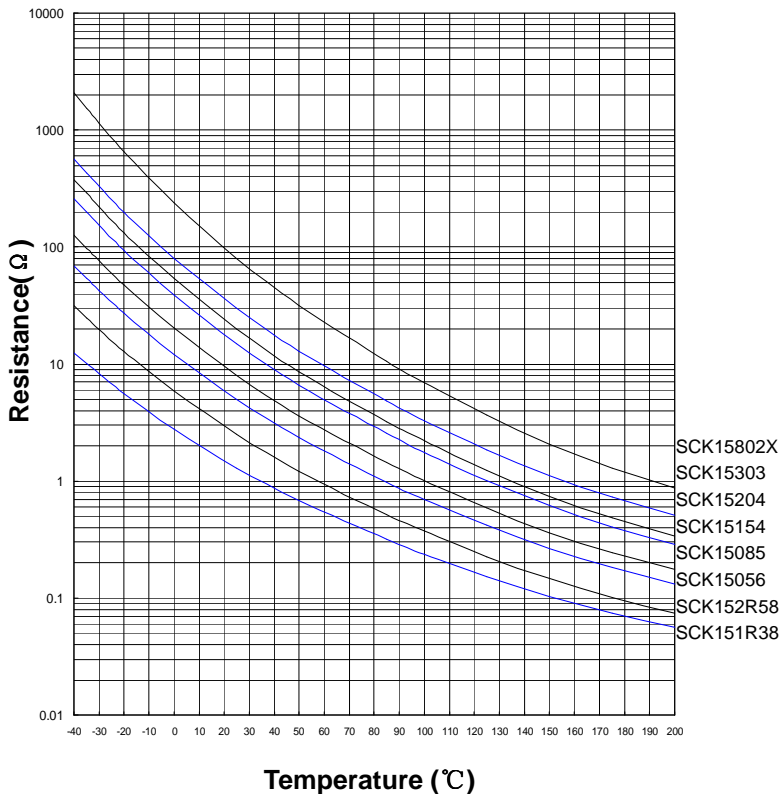

# NTC Thermistor: SCK Series

## Power Thermistor for Limiting Inrush Current



### ■ R-T Characteristic Curves (representative)

**SCK200R7~SCK20180**

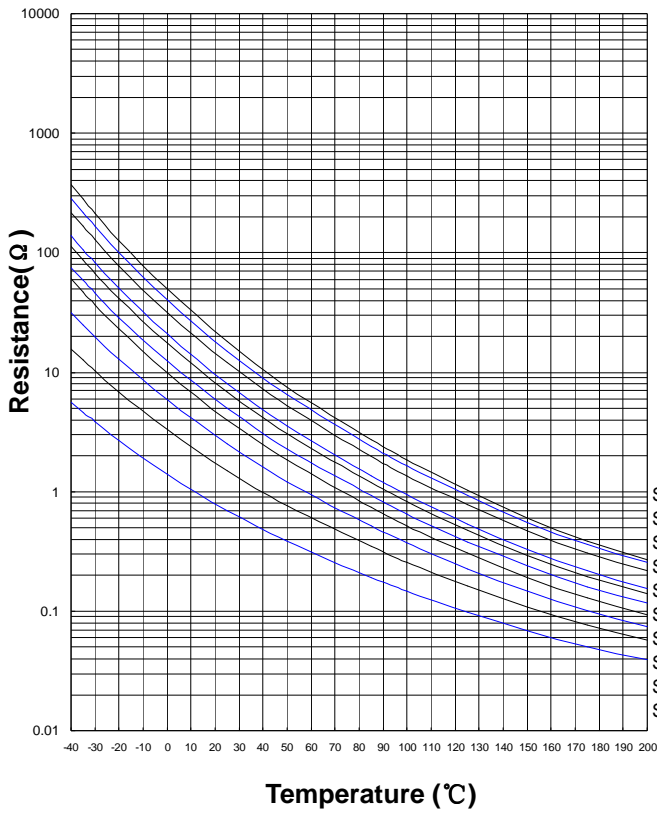

**SCK201R0~SCK20200**

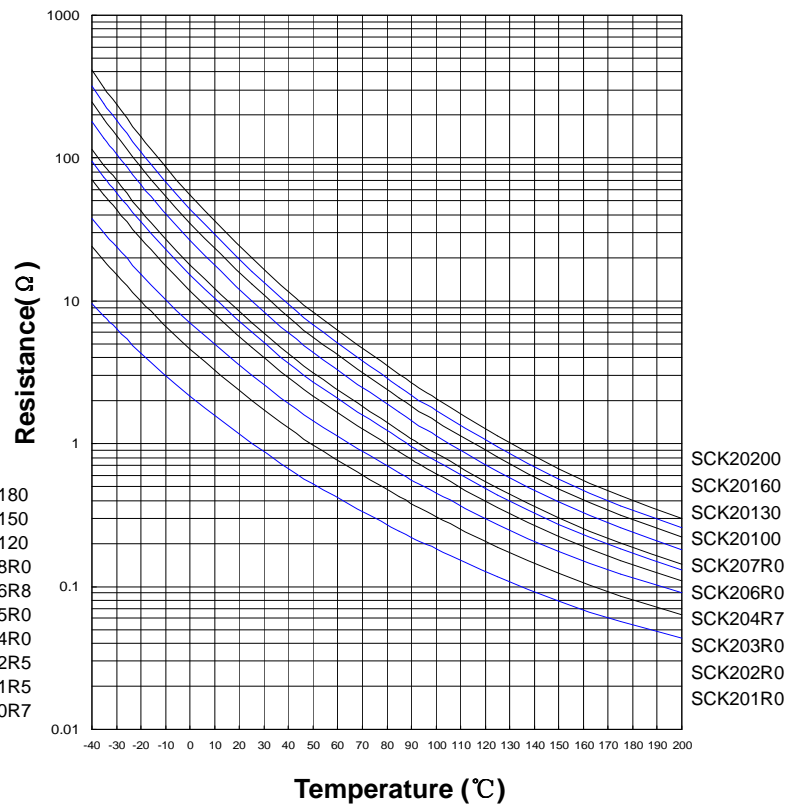

**SCK251R0~SCK25180**

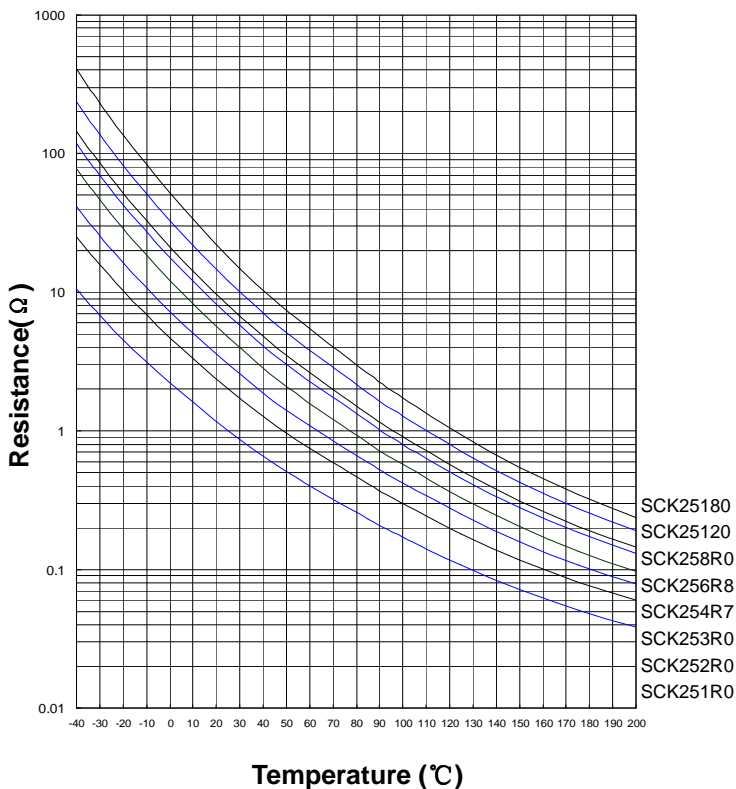

**SCK251R5~SCK25200**

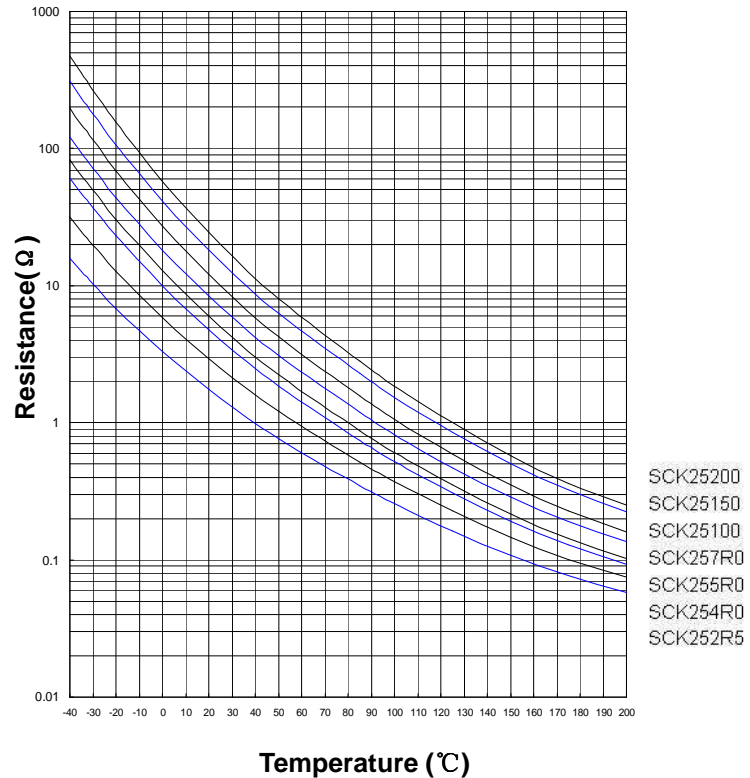

# NTC Thermistor: SCK Series

## Power Thermistor for Limiting Inrush Current



### ■ R-T Characteristic Curves (representative)

SCK301R0 ~ SCK30180

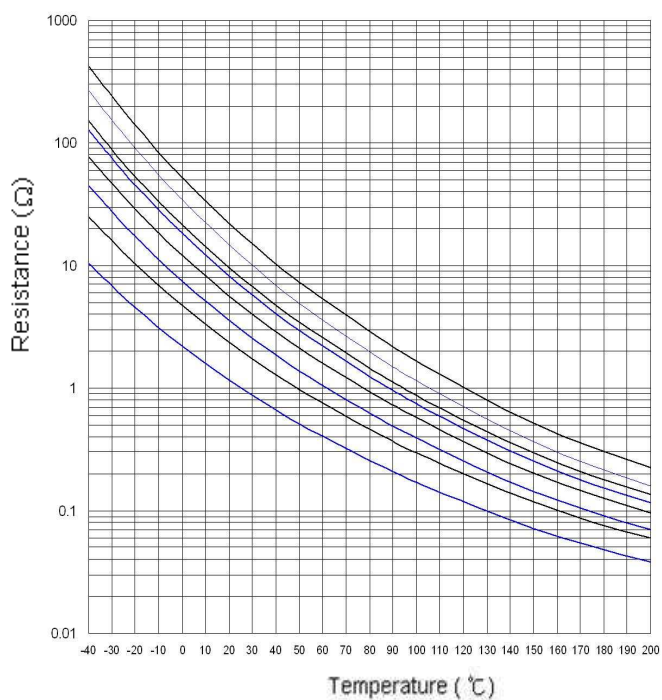

SCK301R5 ~ SCK30200

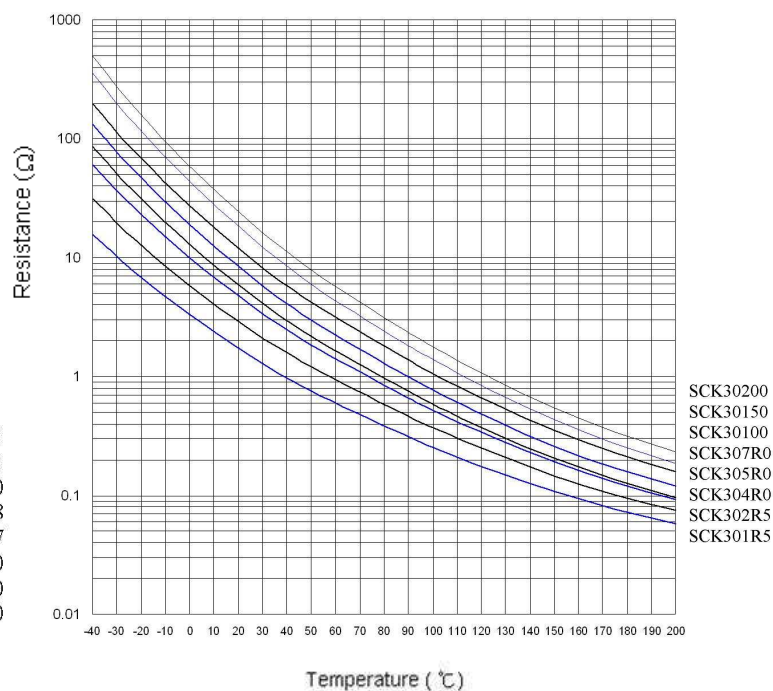

# NTC Thermistor: SCK Series

## Power Thermistor for Limiting Inrush Current



### ■ V-I Characteristic Curves (representative)

**SCK05052~SCK0520X3**

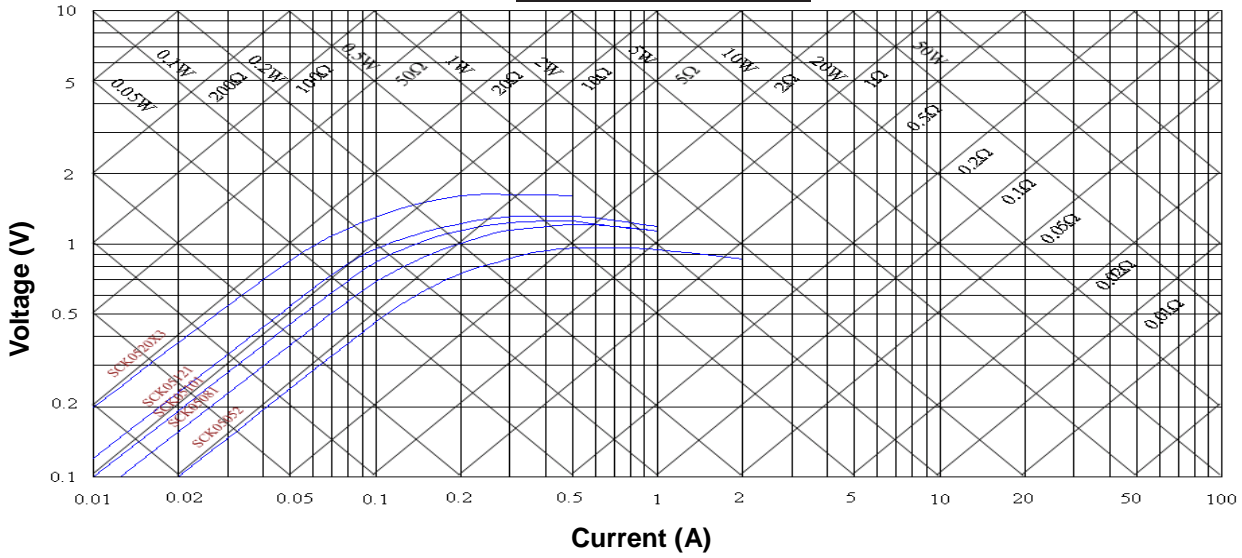

**SCK08042~SCK08201**

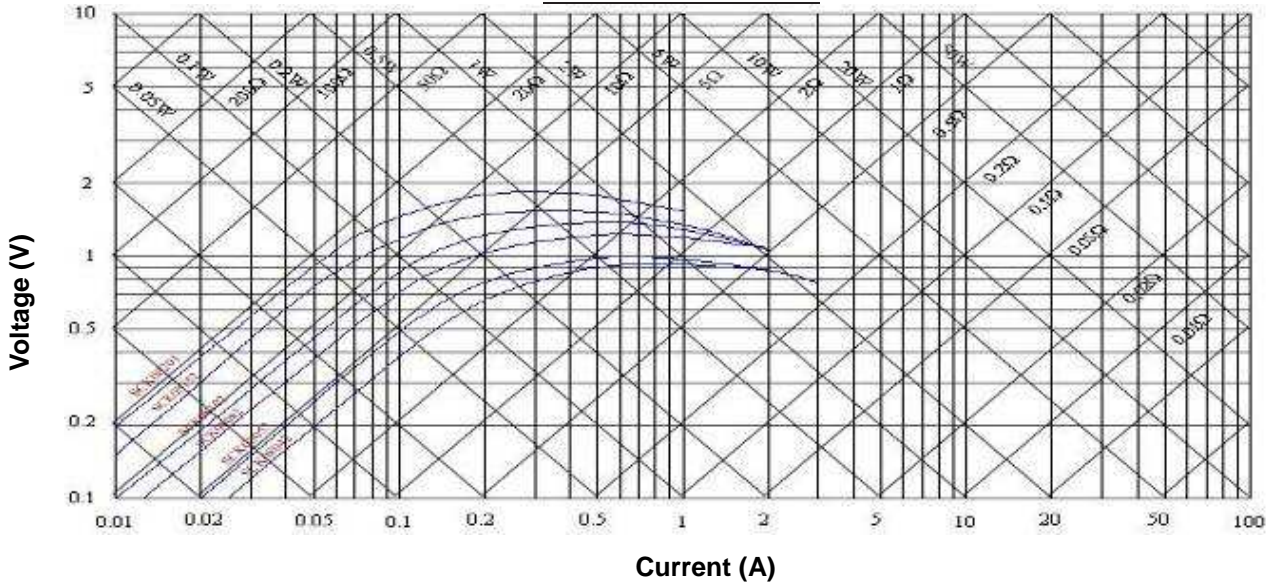

**SCK10015~SCK101201**

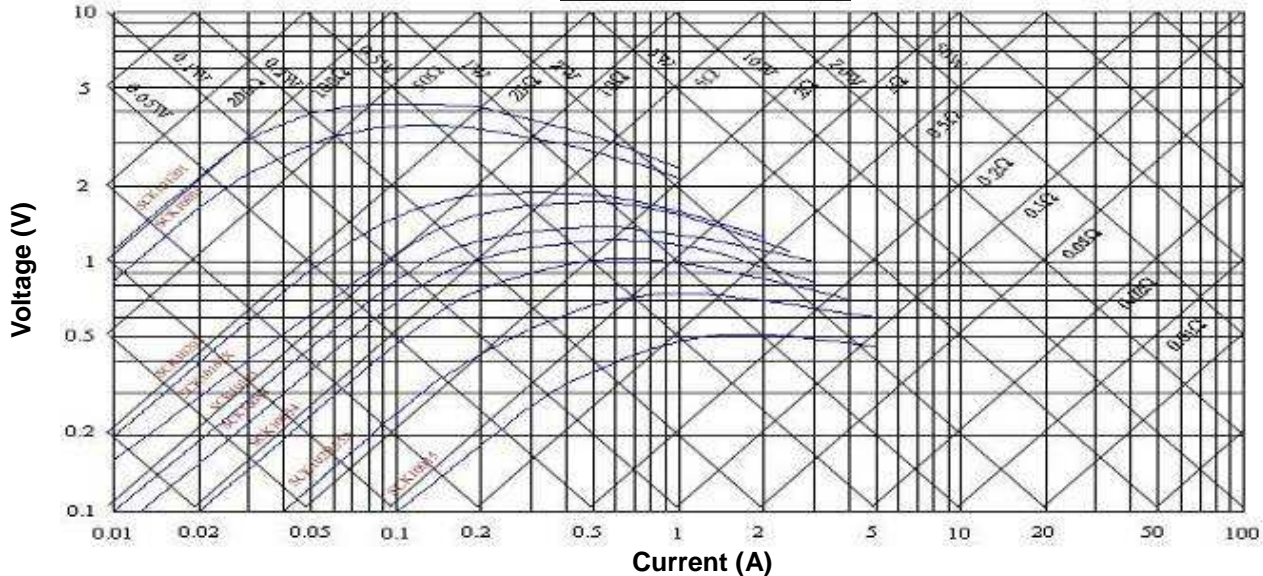

# NTC Thermistor: SCK Series

## Power Thermistor for Limiting Inrush Current



SCK131R37~SCK13203

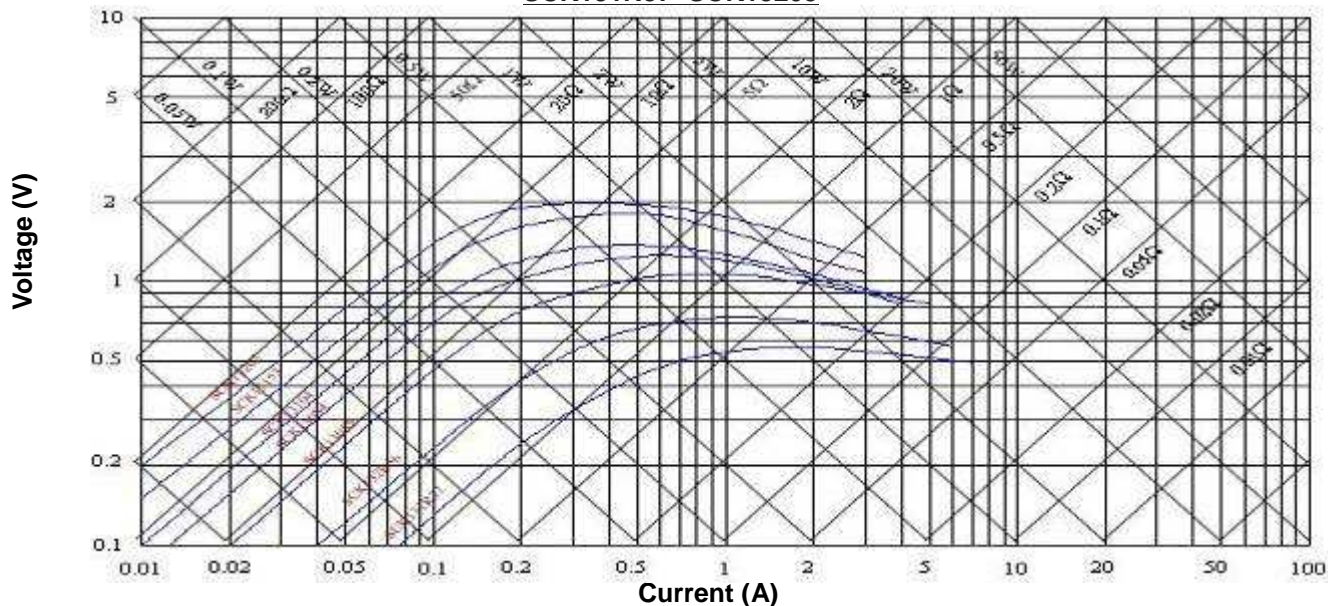

SCK151R38~SCK15473

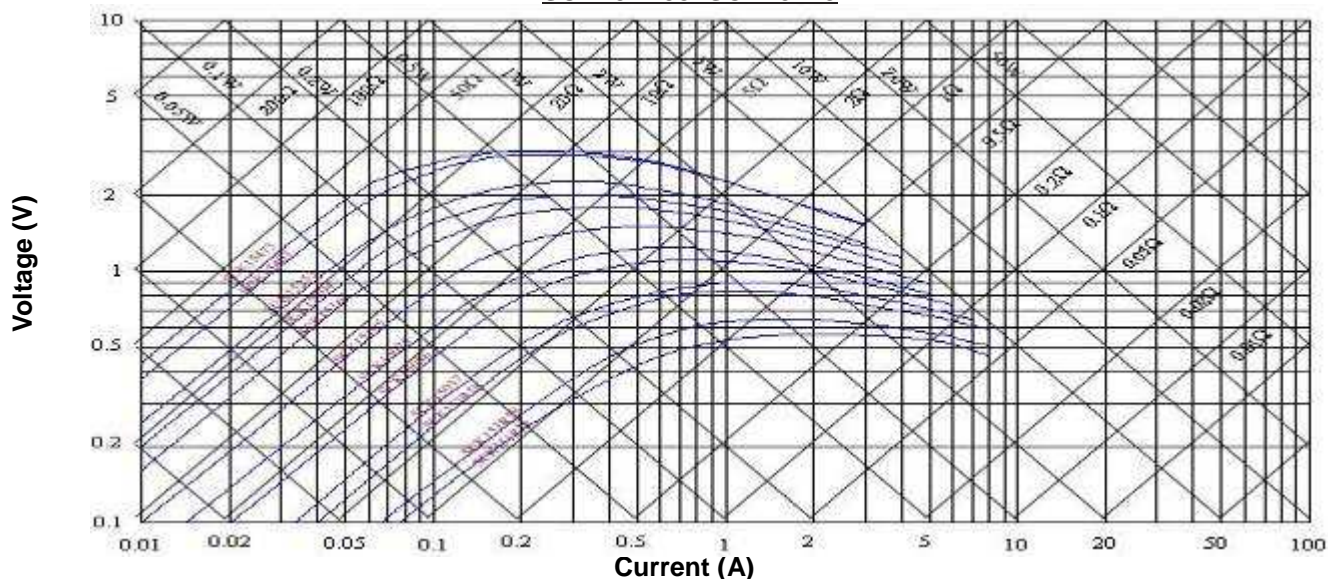

SCK201R0~SCK20200

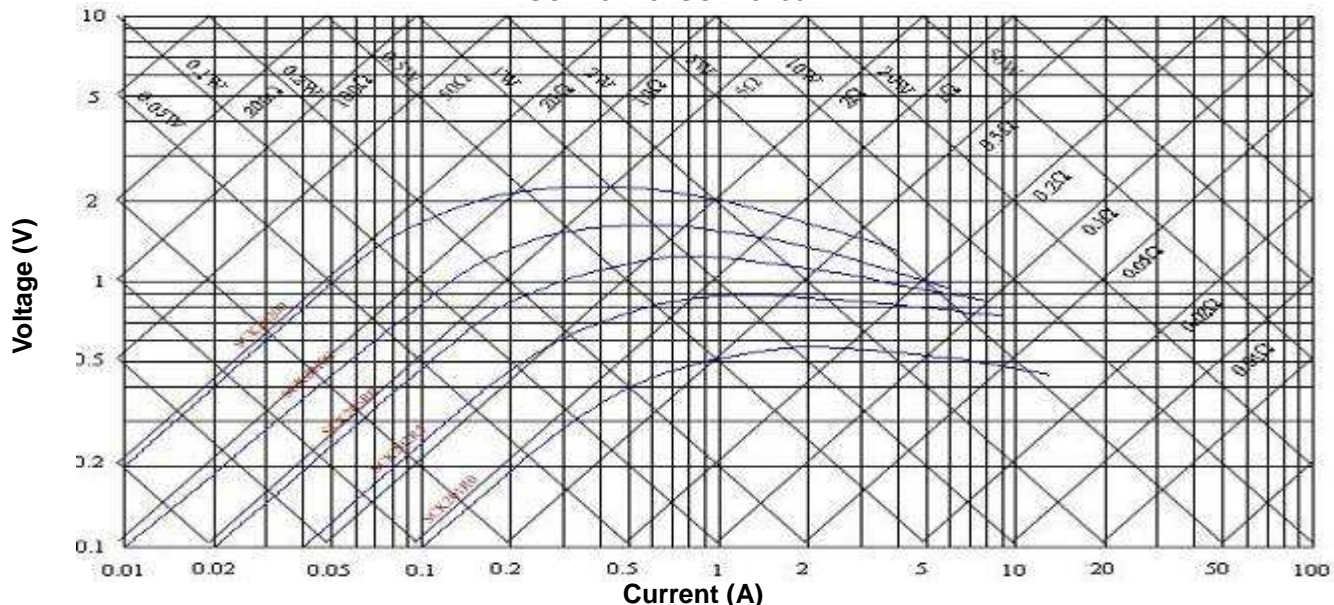

# NTC Thermistor: SCK Series

## Power Thermistor for Limiting Inrush Current



SCK251R0~SCK25200

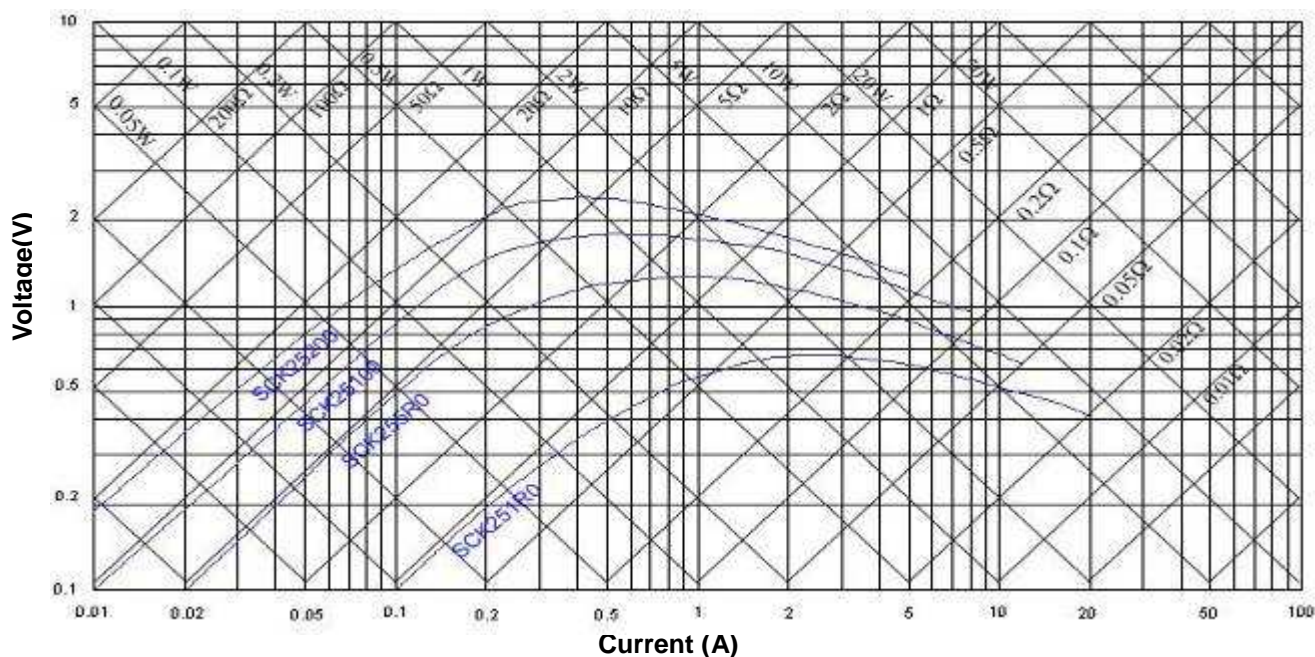

SCK301R0~SCK30200

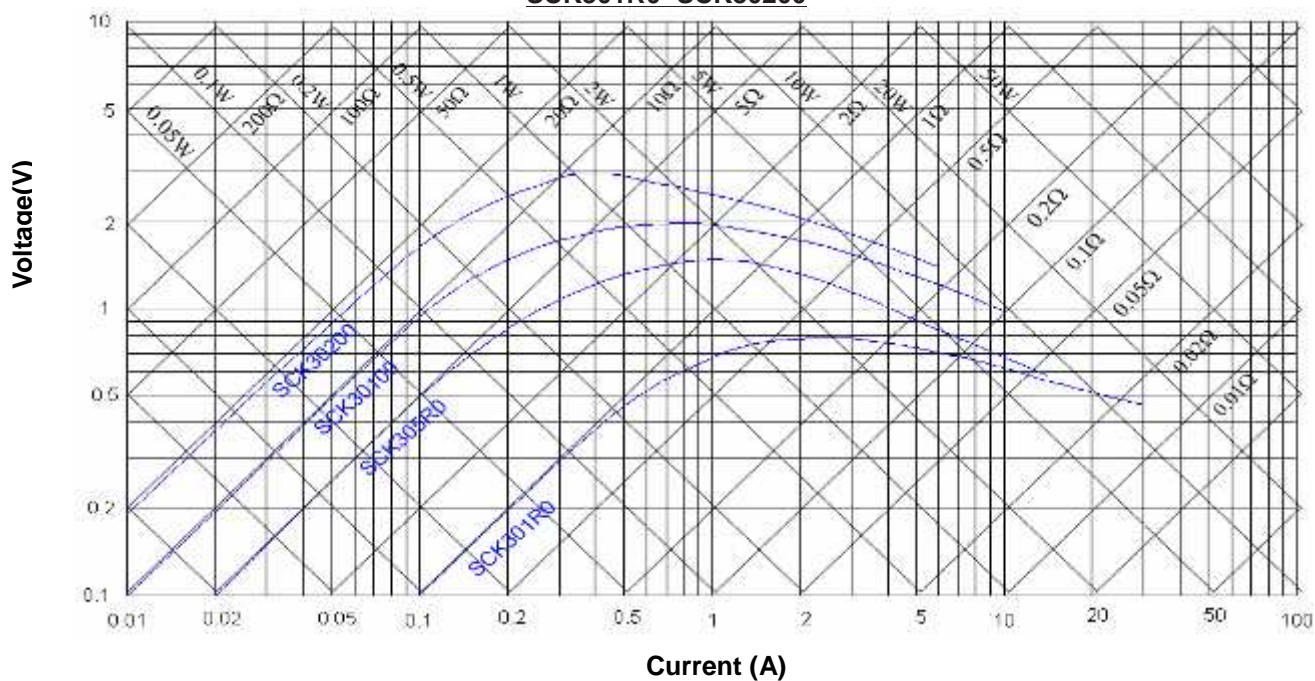

# NTC Thermistor: SCK Series

## Power Thermistor for Limiting Inrush Current



### ■ Soldering Recommendation

#### ● Wave Soldering Profile

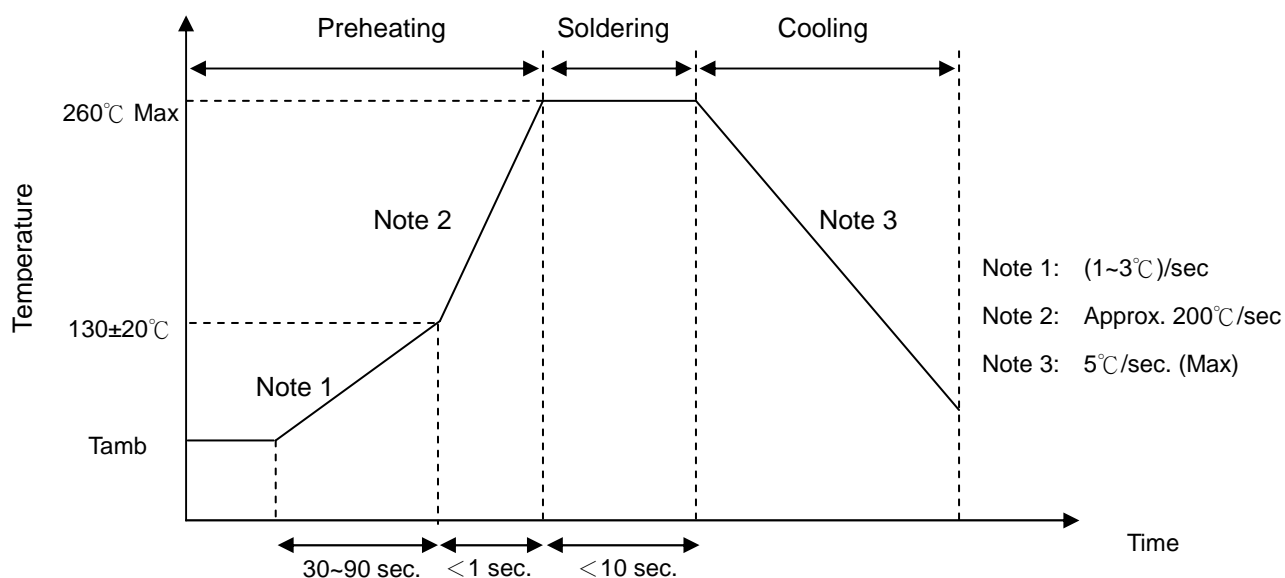

#### ● Recommended Reworking Conditions with Soldering Iron

Item	Conditions
Temperature of Soldering Iron-tip	$360^\circ\text{C}$ (max.)
Soldering Time	3 sec (max.)
Distance from Thermistor	2 mm (min.)

# NTC Thermistor: SCK Series

## Power Thermistor for Limiting Inrush Current



### ■ Reliability

Item	Standard	Test conditions / Methods	Specifications															
Tensile Strength of Terminals	IEC60068-2-21	Gradually applying the force specified and keeping the unit fixed for 10±1 sec.  <table style="width: 100%; border-collapse: collapse;"> <tr> <td style="text-align: center; border-bottom: 1px solid black;">Terminal diameter (mm)</td> <td style="text-align: center; border-bottom: 1px solid black;">Force (Kg)</td> </tr> <tr> <td style="text-align: center;">0.5&lt;d≤0.80</td> <td style="text-align: center;">1.0</td> </tr> <tr> <td style="text-align: center;">0.8&lt;d≤1.25</td> <td style="text-align: center;">2.0</td> </tr> </table>	Terminal diameter (mm)	Force (Kg)	0.5<d≤0.80	1.0	0.8<d≤1.25	2.0	No visible damage									
Terminal diameter (mm)	Force (Kg)																	
0.5<d≤0.80	1.0																	
0.8<d≤1.25	2.0																	
Solderability	IEC60068-2-20	245 ± 5°C, 3 ± 0.3 sec.	At least 95% of terminal electrode is covered by new solder															
Resistance to Soldering Heat	IEC60068-2-20	260 ± 3°C, 10 ± 1 sec.	No visible damage   ΔR <sub>25</sub> /R <sub>25</sub>   ≤ 10 %															
High Temperature Storage	IEC60068-2-2	T <sub>u</sub> ± 5 °C x 1000± 24 hrs	No visible damage   ΔR <sub>25</sub> /R <sub>25</sub>   ≤ 20 %															
Damp Heat, Steady State	IEC60068-2-3	40 ± 2°C, 90~95% RH, 1000 ± 24 hrs	No visible damage   ΔR <sub>25</sub> /R <sub>25</sub>   ≤ 20 %															
Rapid Change of Temperature	IEC60068-2-14	The conditions shown below shall be repeated 5 cycles  <table border="1" style="width: 100%; border-collapse: collapse; text-align: center;"> <thead> <tr> <th>Step</th> <th>Temperature (°C)</th> <th>Period (minutes)</th> </tr> </thead> <tbody> <tr> <td>1</td> <td>T<sub>L</sub> ± 5</td> <td>30 ± 3</td> </tr> <tr> <td>2</td> <td>Room temperature</td> <td>5 ± 3</td> </tr> <tr> <td>3</td> <td>T<sub>u</sub> ± 5</td> <td>30 ± 3</td> </tr> <tr> <td>4</td> <td>Room temperature</td> <td>5 ± 3</td> </tr> </tbody> </table>	Step	Temperature (°C)	Period (minutes)	1	T <sub>L</sub> ± 5	30 ± 3	2	Room temperature	5 ± 3	3	T <sub>u</sub> ± 5	30 ± 3	4	Room temperature	5 ± 3	No visible damage   ΔR <sub>25</sub> /R <sub>25</sub>   ≤ 20 %
Step	Temperature (°C)	Period (minutes)																
1	T <sub>L</sub> ± 5	30 ± 3																
2	Room temperature	5 ± 3																
3	T <sub>u</sub> ± 5	30 ± 3																
4	Room temperature	5 ± 3																
Max. Current	IEC60539-1	25 ± 5°C, I <sub>max</sub> . x 1000± 24 hrs	No visible damage   ΔR <sub>25</sub> /R <sub>25</sub>   ≤ 20 %															
Endurance	UL1434	25 ± 5°C, I <sub>max</sub> . , C <sub>T</sub> , 1min ON / 5 mins OFF x 1000 cycles C <sub>T</sub> = Capacitance at 240 Vac	No visible damage   ΔR <sub>25</sub> /R <sub>25</sub>   ≤ 20 %															
Insulation Test	MIL-STD-202F -Method 302	1000 V <sub>DC</sub> 1 min	No visible damage ≥ 500 MΩ															



# NTC Thermistor: SCK Series

## Power Thermistor for Limiting Inrush Current



### ■ Packaging

#### ● Taping Specification

For S (Straight lead) type and F (Y kink lead) type

Figure A.

For S lead and F lead

Φ8 to Φ10 Type.

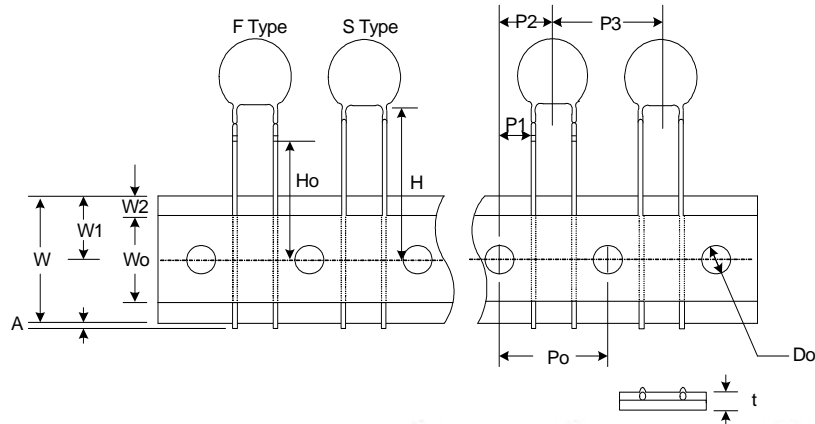

Figure B.

For S lead Φ13 to Φ20 type

and F lead Φ13 to Φ20 type

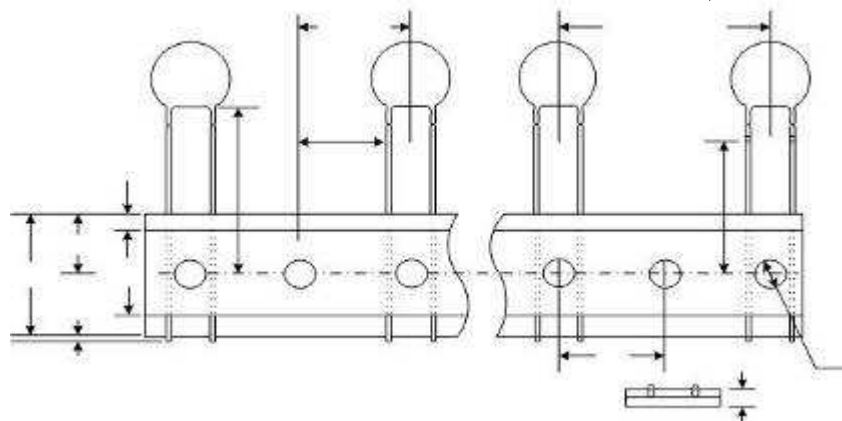
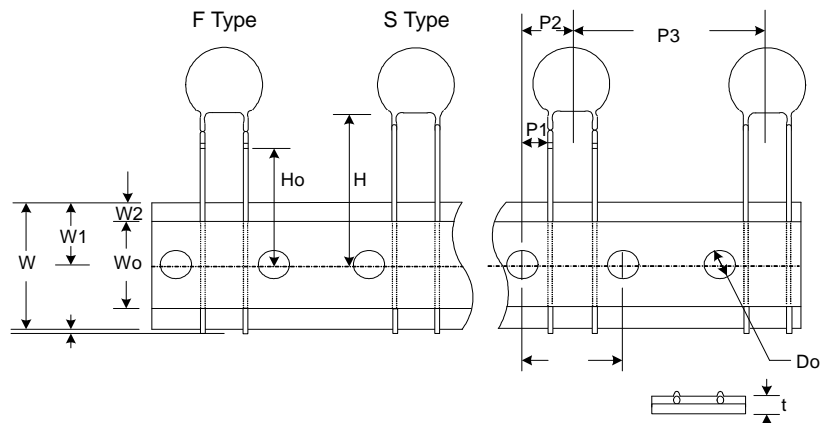

Figure C.

For S lead Φ13 to Φ20 type

and F lead Φ13 to Φ20 type



(Unit: mm)

Taping Code	Body Size	P <sub>0</sub>	P <sub>1</sub>	P <sub>2</sub>	P <sub>3</sub>	H	H <sub>0</sub>	W <sub>0</sub>	W <sub>1</sub>	W <sub>2</sub>	W	A	D <sub>0</sub>	t	Figure
		±0.5	±0.7	±1.3	±0.5	+2/-0	±0.5	±1	±0.5	Max.	±0.5	Max.	±0.2	±0.2	
A (P <sub>0</sub> =12.7)	Φ08	12.7	3.45	6.35	12.7	18	16	12	9	3	18	1	4	0.6	A
	Φ10	12.7	3.45	6.35	12.7	18	16	12	9	3	18	1	4	0.6	A
	Φ13	12.7	8.55	12.7	25.4	18	16	12	9	3	18	1	4	0.6	B
	Φ15	12.7	8.45	12.7	25.4	18	16	12	9	3	18	1	4	0.6	B
	Φ20	12.7	8.45	12.7	25.4	18	16	12	9	3	18	1	4	0.6	B
E (P <sub>0</sub> =15.0)	Φ08	15	4.6	7.5	15	18	16	12	9	3	18	1	4	0.6	A
	Φ10	15	4.6	7.5	15	18	16	12	9	3	18	1	4	0.6	A
	Φ13	15	3.35	7.5	30	18	16	12	9	3	18	1	4	0.6	C
	Φ15	15	3.25	7.5	30	18	16	12	9	3	18	1	4	0.6	C
	Φ20	15	3.25	7.5	30	18	16	12	9	3	18	1	4	0.6	C

# NTC Thermistor: SCK Series

## Power Thermistor for Limiting Inrush Current



### ■ Quantity

#### ● Bulk Packing

Body Size/mm	Standard Lead Type Quantity (pcs/bag)	Cut Lead Type Quantity (pcs/bag)	L kink Type Quantity (pcs/bag)
Φ05	250	500	---
Φ08	250	250	200
Φ10	200	250	200
Φ13	100	200	100
Φ15	100	100	100
Φ20	500 (pcs/ box)	50	50
Φ25	168 (pcs/ box)	168 (pcs/ box)	---
Φ30	168 (pcs/ box)	168 (pcs/ box)	---

#### ● Reel Packing

Body Size/mm	D (mm)	D1 (mm)	W (mm)	Quantity (pcs/reel)
Φ05	340±10	31±1	40±1	2,500
Φ08			55±1	1,500
Φ10				1,500
Φ13				750
Φ15				750
Φ20			500	

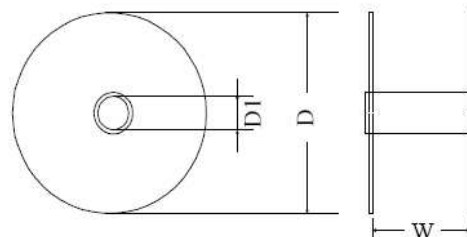

#### ● Ammo Packing

Body Size/mm	Quantity (pcs/box)
Φ05	1,000
Φ08	1,000
Φ10	1,000
Φ13	500
Φ13	500
Φ15	500
Φ20	500

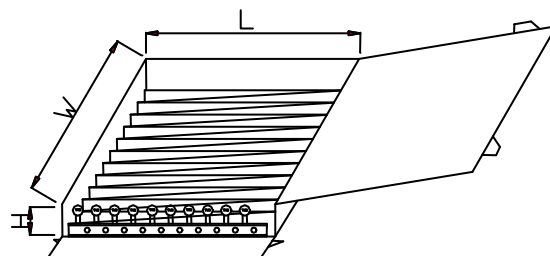

(Unit: mm)

Body Size	W	L	H
Φ5~Φ15	348	275	60

# NTC Thermistor: SCK Series

## Power Thermistor for Limiting Inrush Current

---



### ■ Storage Conditions of Products

- Storage Conditions :
  1. Storage Temperature :  $-10^{\circ}\text{C} \sim +40^{\circ}\text{C}$
  2. Relative Humidity :  $\leq 75\% \text{RH}$
  3. Keep away from corrosive atmosphere and sunlight.
- Shelf life : 1 year