

4855452 INTERNATIONAL RECTIFIER

55C 05091 D  
Data Sheet No. PD-2.039B

T-03-19

INTERNATIONAL RECTIFIER 

## 30FQ & 30FQ-A SERIES

### 30 Amp Schottky Power Rectifiers

#### Major Ratings and Characteristics

Characteristic	30FQ	30FQ-A	Units
$I_F(AV)$ @ 180° Rectangular	30		A
$I_{FSM}$ @ 50 Hz	575		A
$I^2t$ @ 50 Hz	1650		A <sup>2</sup> s
$I^2\sqrt{t}$	23,000	25,000	A <sup>2</sup> $\sqrt{s}$
$V_{RWM}$	30 to 45		V
$C_t @ -5V$	2000		pF
$T_J$	-65 to 175		°C

#### Description/Features

The 30FQ and 30FQ-A Series Schottky rectifiers are designed to be operated at 175°C T<sub>J</sub>. They employ the "830" process which results in a very low ratio of reverse leakage current to junction temperature. In addition to improvements in reliability and performance, they are rugged devices with a guaranteed repetitive peak reverse voltage capability and excellent ability to withstand reverse energy transients. They can be used for both existing and new designs.

- 175°C T<sub>J</sub> operation
- High current at high temperature
- Extremely low reverse leakage: 25 mA at 125°C
- No voltage derating up to 175°C
- Provides extremely high power supply reliability
- No thermal runaway within operating and temperature parameters.
- A guaranteed repetitive peak reverse voltage capability for short pulses which is 20% above V<sub>RWM</sub>
- Ability to withstand reverse energy transients
- Can be supplied to meet stringent military, aerospace and other high-reliability requirements.



#### CASE STYLE AND DIMENSIONS

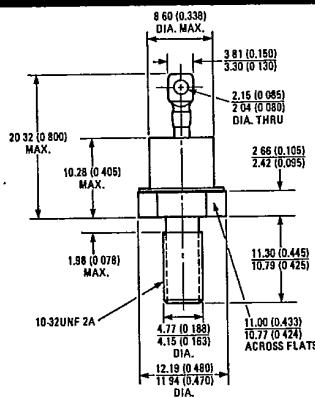
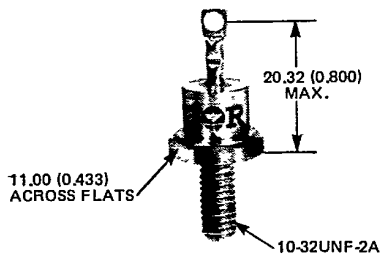

Case Style DO-203AA (DO-4)  
All Dimensions in Millimeters and (Inches)

4855452 INTERNATIONAL RECTIFIER  
30FQ & 30FQ-A Series

55C 05092 D  
INTERNATIONAL RECTIFIER 

T-03-19

VOLTAGE RATINGS

Part Numbers		$V_{RWM}$ - Max. Working Peak Reverse Voltage (V) ①	$V_{RRM}$ - Max. Repetitive Peak Reverse Voltage (V) ② (200 ns Max. Pulse Width)	$V_R$ - Max. Direct Reverse Voltage (V) ③
30FQ030	30FQ030A	30	36	30
30FQ035	30FQ035A	35	42	35
30FQ040	30FQ040A	40	48	40
30FQ045	30FQ045A	45	54	45

ELECTRICAL SPECIFICATIONS

	30FQ	30FQ-A	Units	Conditions
$I_{F(AV)}$ Max. average forward current	30		A	180° conduction, rectangular waveform @ $T_C = -65$ to $119^\circ\text{C}$ for 30FQ, and @ $T_C = -65$ to $123^\circ\text{C}$ for 30FQ-A.
	27			180° conduction, sinusoidal waveform
$I_{FSM}$ Max. peak one cycle, non-repetitive surge current	575	590	A	60 Hz Half cycle, sine wave or 6 ms rectangular pulse, following any rated load condition, and with rated $V_{RWM}$ applied following surge.
	600	620		60 Hz Half cycle, sine wave or 5 ms rectangular pulse, following any rated load condition, and with rated $V_{RWM}$ applied following surge.
	680	705		50 Hz With $V_{RWM} = 0$ following surge, initial $T_J = 175^\circ\text{C}$
	715	735		60 Hz
$i^2t$ Max. $i^2t$ for fusing	1,650	1,750	$\text{A}^2\text{s}$	10 ms With rated $V_{RWM}$ applied following surge, initial $T_J = 175^\circ\text{C}$ .
	1,600	1,600		8.3 ms
$i^2t$ Max. $i^2t$ for individual device fusing	2,300	2,500	$\text{A}^2\text{s}$	10 ms With $V_{RWM}$ applied following surge = 0, initial $T_J = 175^\circ\text{C}$ .
	2,100	2,250		8.3 ms
$i^2\sqrt{t}$ Max. $i^2\sqrt{t}$ for individual device fusing ④	23,000	25,000	$\text{A}^2\sqrt{\text{s}}$	$t = 0.1$ to $10$ ms, $V_{RWM}$ following surge = 0, initial $T_J = 175^\circ\text{C}$
$V_{FM}$ Max. peak forward voltage	0.83	0.75	V	$T_J = 25^\circ\text{C}$ Rated $I_{F(AV)}$ (60A peak) 180° conduction, rectangular waveform
	0.73	0.67		$T_J = 175^\circ\text{C}$
	0.67	0.60		$T_J = 25^\circ\text{C}$ @ $I_{FM} = 30\text{A}$
	0.60	0.54		$T_J = 25^\circ\text{C}$ @ $I_{FM} = 20\text{A}$
$I_{RM}$ Max. peak reverse current	15		mA	$T_J = 25^\circ\text{C}$
	30			$T_J = 125^\circ\text{C}$ At max. rated $V_{RWM}$
$I_{RRM}$ Max. repetitive peak reverse current	2.0		A	$T_C = 25^\circ\text{C}$ , $f = 1$ kHz, see fig. 1.6 for test circuit
$C_t$ Max. capacitance	2000		pF	$T_C = 25^\circ\text{C}$ , $V_R = 5$ Vdc (Test signal in the range of 100 kHz to 1 MHz.)
$dv/dt$ Max. rate of reverse voltage application	1000		V/ $\mu\text{s}$	$T_C = 25^\circ\text{C}$ , $V_{RM} = \text{rated } V_{RWM}$

THERMAL-MECHANICAL SPECIFICATIONS

$T_J$ Max. operating junction temperature range	-65 to 175	$^\circ\text{C}$	
$T_{stg}$ Max. storage temperature range	-65 to 175	$^\circ\text{C}$	
$R_{thJC}$ Max. thermal resistance, junction-to-case	2.0	deg C/W	DC operation
$R_{thCS}$ Max. thermal resistance, case-to-sink	0.50	deg C/W	Mounting surface flat, smooth and greased
T Mounting torque	Min.	1.35 (12)	Nm (lbf in)
	Max.	1.70 (15)	
wt Approximate weight	5.7 (0.20)	g (oz)	Non-lubricated threads
Case style	DO-203AA (DO-4)		JEDEC

①  $T_C = -65^\circ\text{C}$  to  $167^\circ\text{C}$ , 180° conduction.

③  $T_C = 0^\circ\text{C}$  to  $167^\circ\text{C}$ , 180° conduction.

②  $T_C = -65^\circ\text{C}$  to  $148^\circ\text{C}$

④  $i^2t$  for time  $t_x = i^2\sqrt{t} \cdot \sqrt{t_x}$

4855452 INTERNATIONAL RECTIFIER  
INTERNATIONAL RECTIFIER **IR**

55C 05093 D  
30FQ & 30FQ-A Series

30FQ Series

T-03-19

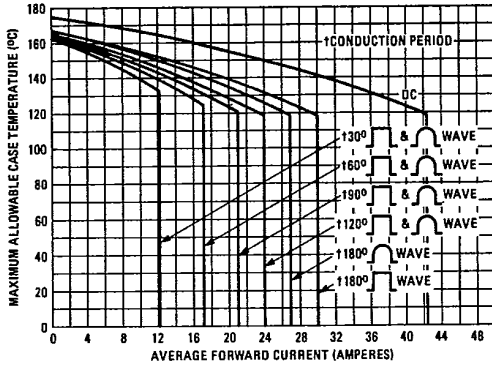

Fig. 1 - Maximum Allowable Case Temperature Vs. Forward Current

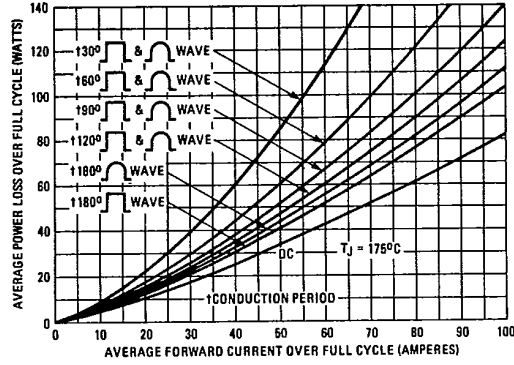

Fig. 2 - Maximum Forward Power Loss Vs. Forward Current

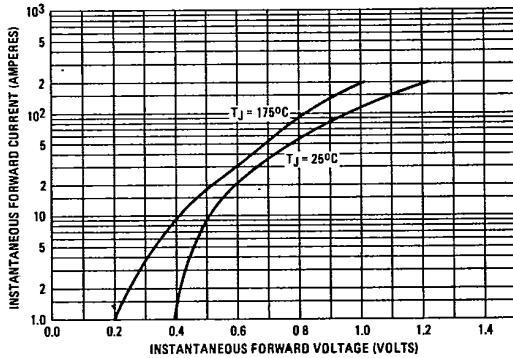

Fig. 3 - Maximum Forward Voltage Vs. Forward Current

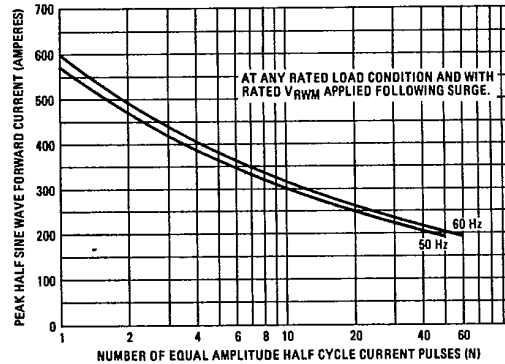

Fig. 4 - Maximum Non-Repetitive Surge Current Vs. Number of Cycles

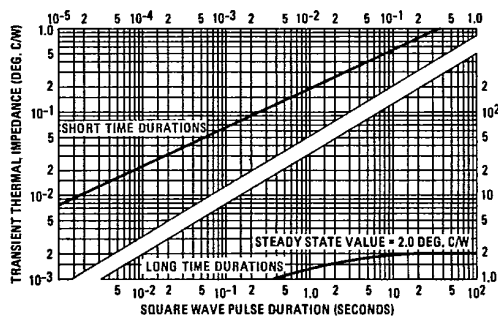

Fig. 5 - Maximum Transient Thermal Impedance, Junction-to-Case Vs. Square Wave Pulse Duration

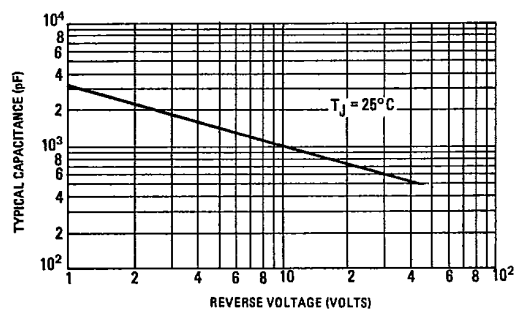

Fig. 6 - Typical Capacitance Vs. Reverse Voltage



4855452 INTERNATIONAL RECTIFIER  
30FQ & 30FQ-A Series

55C 05094 D  
INTERNATIONAL RECTIFIER 

30FQ Series

T-03-19

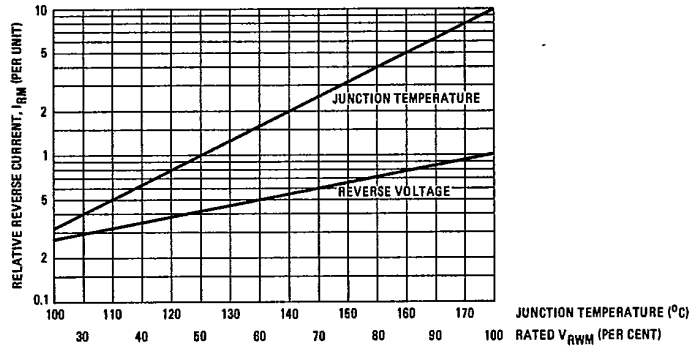

Fig. 7 - Typical Variation of Reverse Current Vs. Junction Temperature and Reverse Voltage

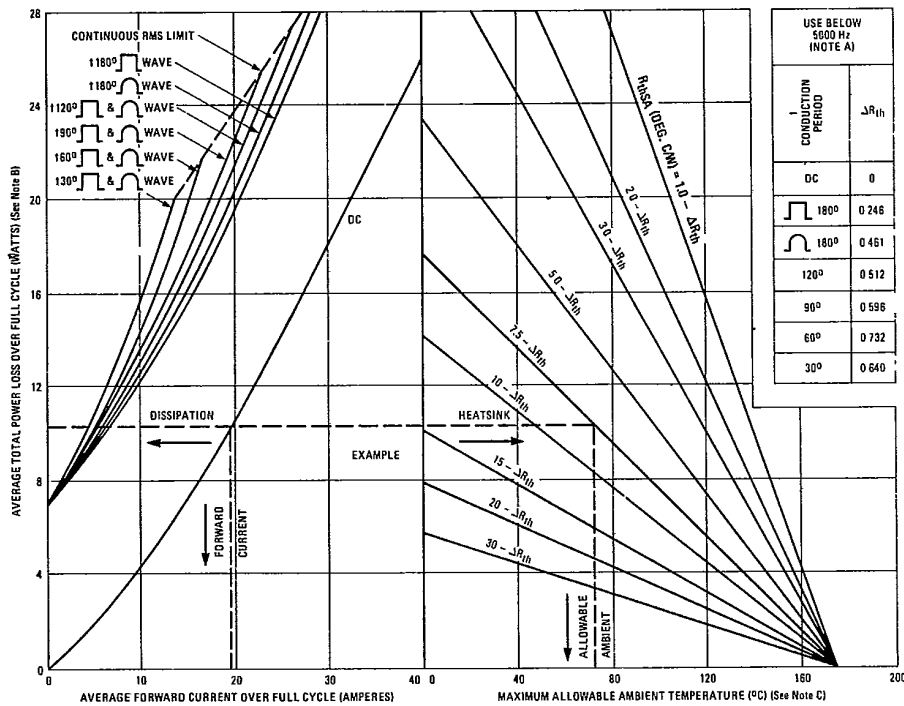

Fig. 8 - Thermal Nomogram

- Notes. A. Maximum allowable heatsink thermal resistance,  $R_{thSA}$ , equals the graph value minus the  $\Delta R_{th}$  factor which allows for instantaneous  $T_j$  excursion. At frequencies above 5000 Hz,  $\Delta R_{th}$  becomes essentially zero and can be ignored.
- B. The total power dissipation curves assume the worst case reverse conditions of half-wave (180°) rectangular reverse voltage, full rated  $V_R$ , and  $T_j = 175^\circ\text{C}$ . Lower reverse power losses allow higher operating ambient, smaller heatsinks or larger operating safety margin.
- C. Caution. Data assumes that the rectifier is mounted with thermally conductive grease to achieve  $R_{thCS} = 0.50$  deg. CW.

4855452 INTERNATIONAL RECTIFIER

55C 05095 D  
30FQ & 30FQ-A Series



T-03-19

30FQ-A Series

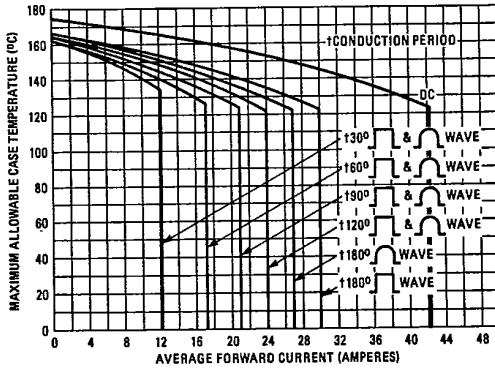

Fig. 9 - Maximum Allowable Case Temperature Vs. Forward Current

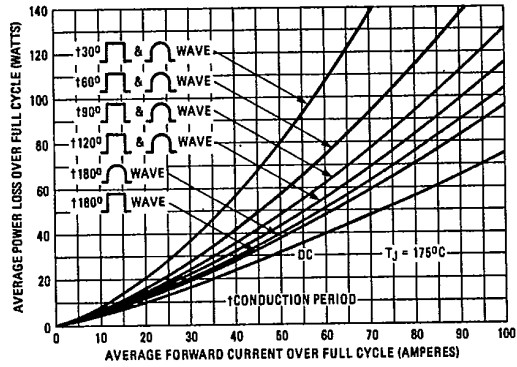

Fig. 10 - Maximum Forward Power Loss Vs. Forward Current

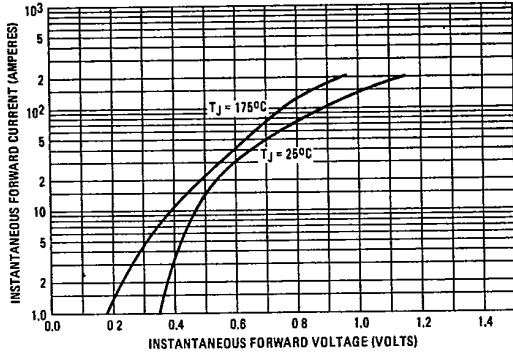

Fig. 11 - Maximum Instantaneous Forward Voltage Vs. Forward Current

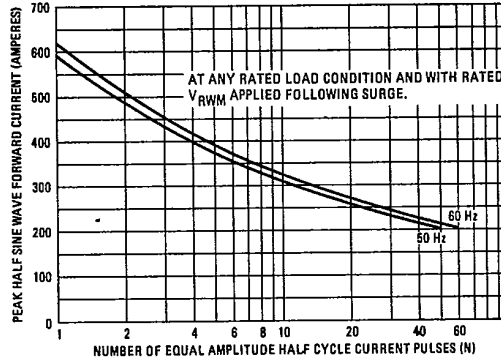

Fig. 12 - Maximum Non-Repetitive Surge Current Vs. Number of Current Pulses

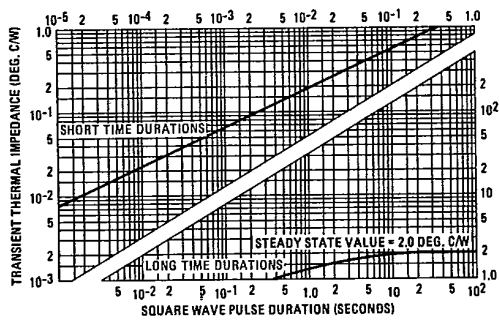

Fig. 13 - Maximum Transient Thermal Impedance, Junction-to-Case Vs. Square Wave Pulse Duration

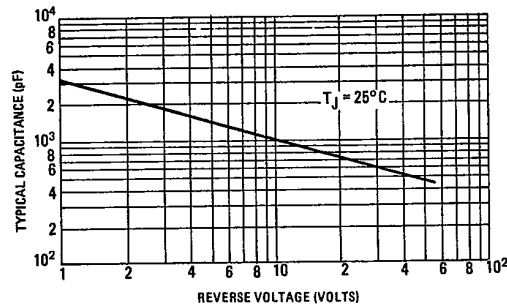

Fig. 14 - Typical Capacitance Vs. Reverse Voltage

C

4855452 INTERNATIONAL RECTIFIER  
30FQ & 30FQ-A Series

55C 05096 D  
INTERNATIONAL RECTIFIER **IR**

T-03-19

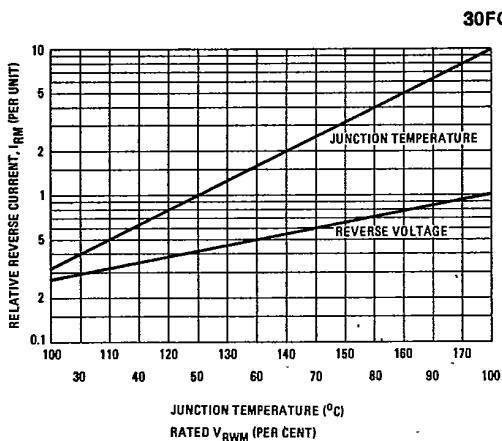

Fig. 15 - Typical Variation of Reverse Current Vs. Junction Temperature and Reverse Voltage

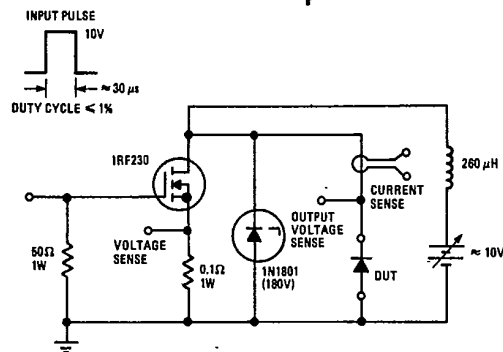

Fig. 16 - I<sub>RRM</sub> Test Circuit

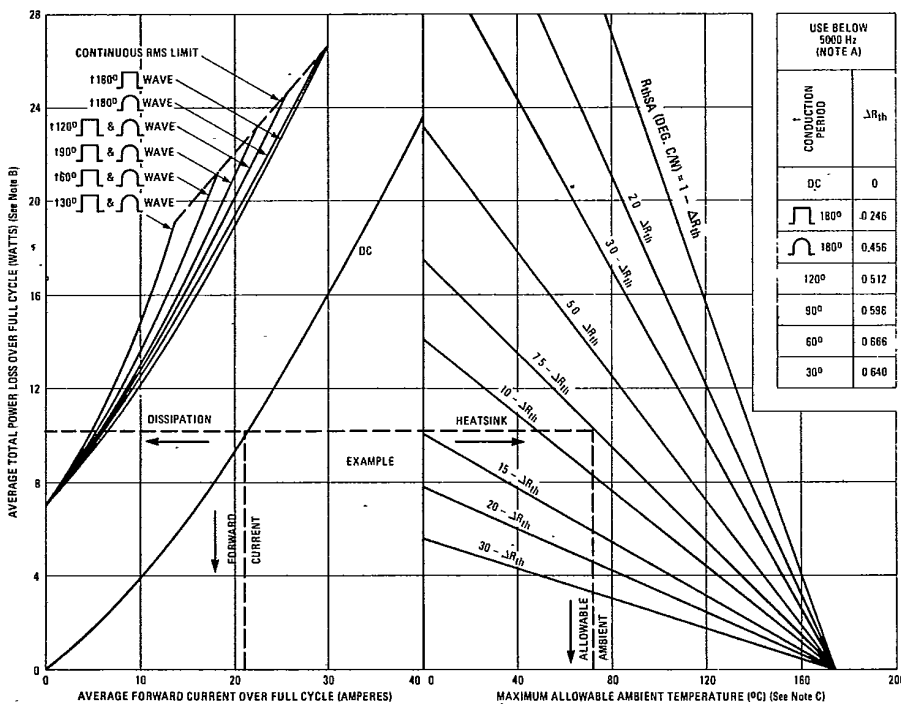

Fig. 17 - Thermal Nomogram

- Notes:
- Maximum allowable heatsink thermal resistance,  $R_{\theta SA}$ , equals the graph value minus the  $\Delta R_{\theta JA}$  factor which allows for instantaneous  $T_J$  excursion. At frequencies above 5000 Hz,  $\Delta R_{\theta JA}$  becomes essentially zero and can be ignored.
  - The total power dissipation curves assume the worst case reverse conditions of halfwave (180°) rectangular reverse voltage, full rated  $V_R$ , and  $T_J = 175^\circ\text{C}$ . Lower reverse power losses allow higher operating ambient, smaller heatsinks or larger operating safety margin.
  - Caution: Data assumes that the rectifier is mounted with thermally conductive grease to achieve  $R_{\theta CS} = 0.50$  deg. C/W