

908-721

# BATTERY CONTACTS & CLIPS

Designers' Choice



## SNAP-ON CONTACTS FOR "A" • "AA" • "AAA" • "AAAA" • "N" SIZES

Single Contact

Dual Contact

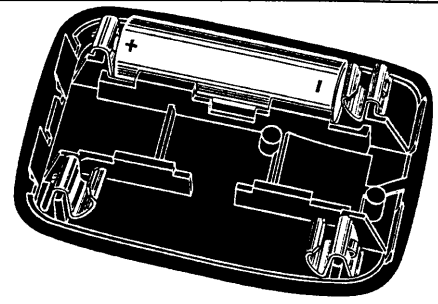
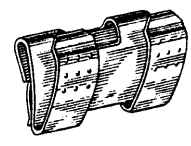
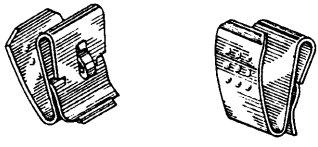

CAT. NO. 209 - For "A" • "AA"  
CAT. NO. 204 - For "AAA" • "AAAA" • "N"

CAT. NO. 210 - For "A" • "AA"  
CAT. NO. 202 - For "AAA" • "AAAA" • "N"

- Economical and reliable contacts are ideal for molded cases with self contained battery compartments
- Single & dual contact designs available for "A" • "AA" • "AAA" • "AAAA" • "N" size batteries
- Solder "ear" to facilitate soldering of wire lead
- Unique spring tension contact adjusts to variations in battery length
- Reliable spring tension contacts assure low contact resistance
- Clips easily onto .060 to .070 thick panel edges
- Sharp barbs securely anchor contact in place

For "A" • "AA"

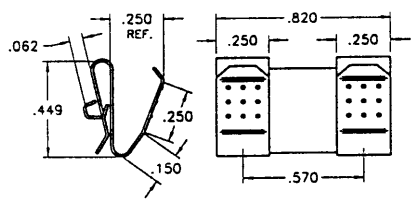
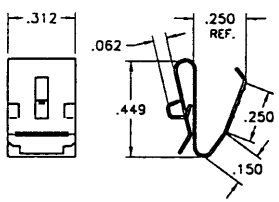

CAT. NO. 209

MATERIAL  
.012 Spring Steel,  
Nickel Plate

CAT. NO. 210

MATERIAL  
.012 Spring Steel,  
Nickel Plate

For "AAA" • "AAAA" • "N"

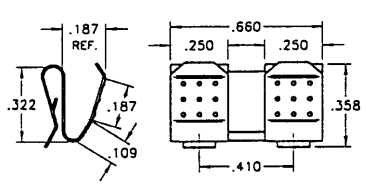
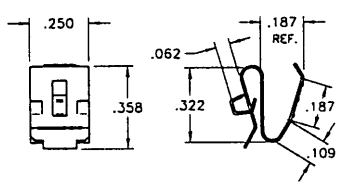

CAT. NO. 204

MATERIAL  
.010 Spring Steel,  
Nickel Plate

CAT. NO. 202

MATERIAL  
.010 Spring Steel,  
Nickel Plate

Single Contact, (+) Pole

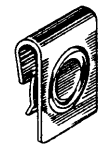

For "A" • "AA"

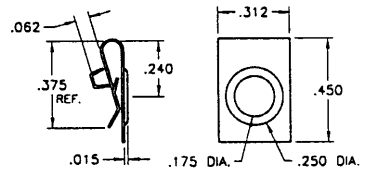

CAT. NO. 228

MATERIAL  
.010 Spring Steel,  
Nickel Plate

## SNAP-IN PC BATTERY CLIPS FOR "A" • "AA" • "AAA" • "N" SIZES

- Available for "A" • "AA" • "AAA" • "N" size batteries
- Mounts securely to the PC board with advanced "Snap-In" design for thru hole mounting
- "Snap-In" clip holds firmly for wave soldering

- Reliable spring tension assures low contact resistance
- Low profile, economical design
- Retains battery securely to withstand shock and vibration

908-721 | 733

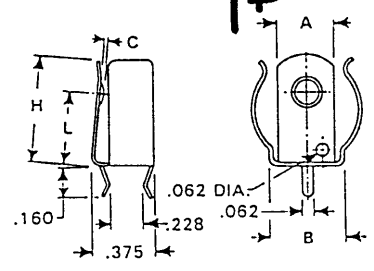
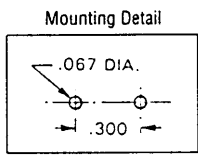
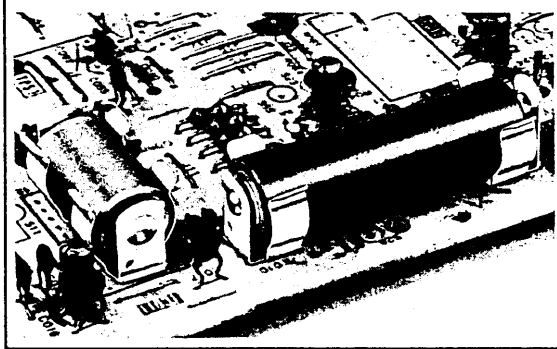

MATERIAL: Spring Steel, Nickel Plate

CAT. NO.	BATTERY SIZE	BATTERY DIA.	A	B	C	H	L	MAT'L THICK
82	"AAA" • "N"	.375-.460	.250	.274	.040	.500	.260	.012
92	"A" • "AA"	.531-.665	.312	.353	.060	.593	.359	.015