

**2,000 V AC
breakdown voltage,
2 Form C and 2 A relays**

TX RELAYS

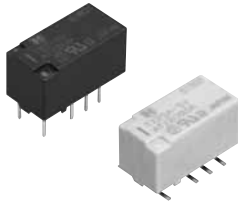

RoHS compliant

FEATURES

- 2,000 V breakdown voltage between contact and coil**
- Outstanding surge resistance.**
1,500 V 10×160μ sec. (FCC part 68) (open contacts)
2,500 V 2×10μ sec. (Telcordia) (contact and coil)
- Nominal operating power: High sensitivity of 140mW**
- High contact capacity: 2 A 30 V DC**
- Compact size**
15.0 (L) × 7.4 (W) × 8.2 (H) mm
.591 (L) × .291 (W) × .323 (H) inch
- High contact reliability**
High contact reliability is achieved by the use of gold-clad twin crossbar contacts, low-gas formation materials, mold sealing the coil section, and by controlling organic gas in the coil.
***We also offer a range of products with AgPd contacts suitable for use in low level load analog circuits (Max. 10V DC 10 mA).**

TYPICAL APPLICATIONS

1. Communications (xDSL, Transmission)
2. Measurement
3. Security
4. Home appliances, and audio/visual equipment
5. Medical equipment

ORDERING INFORMATION



- Contact arrangement
2: 2 Form C
- Surface-mount availability
Nil: Standard PC board terminal type
SA: SA type
- Operating function
Nil: Single side stable
LT: 2 coil latching
- Terminal shape
Nil: Standard PC board terminal or surface-mount terminal
- Nominal coil voltage (DC)*
3, 4.5, 5, 6, 9, 12, 24V
- Contact material
Nil: Standard contact (Ag+Au clad)
1: AgPd contact (low level load); AgPd+Au clad (stationary), AgPd (movable)
- Packing style
Nil: Tube packing
X: Tape and reel (picked from 1/3/4/5-pin side)
Z: Tape and reel packing (picked from the 8/9/10/12-pin side)

Note: In case of 5 V transistor drive circuit, it is recommended to use 4.5 V type relay.

TYPES

1. Standard PC board terminal

Contact arrangement	Nominal coil voltage	Single side stable	2 coil latching
		Part No.	Part No.
2 Form C	3 V DC	TX2-3V	TX2-LT-3V
	4.5 V DC	TX2-4.5V	TX2-LT-4.5V
	5 V DC	TX2-5V	TX2-LT-5V
	6 V DC	TX2-6V	TX2-LT-6V
	9 V DC	TX2-9V	TX2-LT-9V
	12 V DC	TX2-12V	TX2-LT-12V
	24 V DC	TX2-24V	TX2-LT-24V

Standard packing: Tube: 40 pcs.; Case: 1,000 pcs.

Note: Please add "-1" to the end of the part number for AgPd contacts (low level load).

2. Surface-mount terminal

1) Tube packing

Contact arrangement	Nominal coil voltage	Single side stable	2 coil latching
		Part No.	Part No.
2 Form C	3 V DC	TX2SA-3V	TX2SA-LT-3V
	4.5 V DC	TX2SA-4.5V	TX2SA-LT-4.5V
	5 V DC	TX2SA-5V	TX2SA-LT-5V
	6 V DC	TX2SA-6V	TX2SA-LT-6V
	9 V DC	TX2SA-9V	TX2SA-LT-9V
	12 V DC	TX2SA-12V	TX2SA-LT-12V
	24 V DC	TX2SA-24V	TX2SA-LT-24V

Standard packing: Tube: 40 pcs.; Case: 1,000 pcs.

Note: Please add "-1" to the end of the part number for AgPd contacts (low level load).

2) Tape and reel packing

Contact arrangement	Nominal coil voltage	Single side stable	2 coil latching
		Part No.	Part No.
2 Form C	3 V DC	TX2SA-3V-Z	TX2SA-LT-3V-Z
	4.5 V DC	TX2SA-4.5V-Z	TX2SA-LT-4.5V-Z
	5 V DC	TX2SA-5V-Z	TX2SA-LT-5V-Z
	6 V DC	TX2SA-6V-Z	TX2SA-LT-6V-Z
	9 V DC	TX2SA-9V-Z	TX2SA-LT-9V-Z
	12 V DC	TX2SA-12V-Z	TX2SA-LT-12V-Z
	24 V DC	TX2SA-24V-Z	TX2SA-LT-24V-Z

Standard packing: Tape and reel: 500 pcs.; Case: 1,000 pcs.

Notes: 1. Tape and reel packing symbol "-Z" is not marked on the relay. "X" type tape and reel packing (picked from 1/2/3/4-pin side) is also available.

2. Please add "-1" to the end of the part number for AgPd contacts (low level load).

RATING

1. Coil data

1) Single side stable

Nominal coil voltage	Pick-up voltage (at 20°C 68°F)	Drop-out voltage (at 20°C 68°F)	Nominal operating current [$\pm 10\%$] (at 20°C 68°F)	Coil resistance [$\pm 10\%$] (at 20°C 68°F)	Nominal operating power	Max. applied voltage (at 20°C 68°F)
3 V DC	75%V or less of nominal voltage* (Initial)	10%V or more of nominal voltage* (Initial)	46.7 mA	64.3 Ω	140 mW	150%V of nominal voltage
4.5 V DC			31 mA	145 Ω		
5 V DC			28.1 mA	178 Ω		
6 V DC			23.3 mA	257 Ω		
9 V DC			15.5 mA	579 Ω		
12 V DC			11.7 mA	1,028 Ω		
24 V DC			5.8 mA	4,114 Ω		

2) 2 coil latching

Nominal coil voltage	Set voltage (at 20°C 68°F)	Reset voltage (at 20°C 68°F)	Nominal operating current [$\pm 10\%$] (at 20°C 68°F)		Coil resistance [$\pm 10\%$] (at 20°C 68°F)		Nominal operating power		Max. applied voltage (at 20°C 68°F)
			Set coil	Reset coil	Set coil	Reset coil	Set coil	Reset coil	
3 V DC	75%V or less of nominal voltage* (Initial)	75%V or less of nominal voltage* (Initial)	66.7 mA	66.7 mA	45 Ω	45 Ω	200 mW	200 mW	150%V of nominal voltage
4.5 V DC			44.5 mA	44.5 mA	101.2 Ω	101.2 Ω			
5 V DC			40 mA	40 mA	125 Ω	125 Ω			
6 V DC			33.3 mA	33.3 mA	180 Ω	180 Ω			
9 V DC			22.2 mA	22.2 mA	405 Ω	405 Ω			
12 V DC			16.7 mA	16.7 mA	720 Ω	720 Ω			
24 V DC			8.3 mA	8.3 mA	2,880 Ω	2,880 Ω			

*Pulse drive (JIS C 5442-1986)

2. Specifications

Characteristics	Item	Specifications	
Contact	Arrangement	2 Form C	
	Initial contact resistance, max.	Max. 100 mΩ (By voltage drop 6 V DC 1A)	
	Contact material	Standard contact: Ag+Au clad, AgPd contact (low level load): AgPd+Au clad (stationary), AgPd (movable)	
Rating	Nominal switching capacity	Standard contact: 2 A 30 V DC, AgPd contact: 1 A 30 V DC (resistive load)	
	Max. switching power	Standard contact: 60 W (DC), AgPd contact: 30 W (DC) (resistive load)	
	Max. switching voltage	220V DC	
	Max. switching current	Standard contact: 2 A, AgPd contact: 1 A	
	Min. switching capacity (Reference value)*1	10μA 10mV DC	
	Nominal operating power	Single side stable: 140 mW (3 to 24 V DC) 2 coil latching: 200 mW (3 to 24 V DC)	
Electrical characteristics	Insulation resistance (Initial)	Min. 1,000MΩ (at 500V DC) Measurement at same location as "Initial breakdown voltage" section.	
	Breakdown voltage (Initial)	Between open contacts	1,000 Vrms for 1min. (Detection current: 10mA)
		Between contact and coil	2,000 Vrms for 1min. (Detection current: 10mA)
		Between contact sets	1,000 Vrms for 1min. (Detection current: 10mA)
	Surge breakdown voltage (Initial)	Between open contacts	1,500 V (10×160μs) (FCC Part 68)
		Between contacts and coil	2,500 V (2×10μs) (Telcordia)
	Temperature rise (at 20°C 68°F)	Max. 50°C (By resistive method, nominal coil voltage applied to the coil; contact carrying current: 2A.)	
	Operate time [Set time] (at 20°C 68°F)	Max. 4 ms [Max. 4 ms] (Nominal coil voltage applied to the coil, excluding contact bounce time.)	
Release time [Reset time] (at 20°C 68°F)	Max. 4 ms [Max. 4 ms] (Nominal coil voltage applied to the coil, excluding contact bounce time.) (without diode)		
Mechanical characteristics	Shock resistance	Functional	Min. 750 m/s ² (Half-wave pulse of sine wave: 6 ms; detection time: 10μs.)
		Destructive	Min. 1,000 m/s ² (Half-wave pulse of sine wave: 6 ms.)
	Vibration resistance	Functional	10 to 55 Hz at double amplitude of 3.3 mm (Detection time: 10μs.)
		Destructive	10 to 55 Hz at double amplitude of 5 mm
Expected life	Mechanical	Min. 10 ⁸ (at 180 cpm)	
	Electrical (Standard contact)	Min. 10 ⁵ (2 A 30 V DC resistive), 5×10 ⁵ (1 A 30 V DC resistive) (at 20 cpm)	
Conditions	Conditions for operation, transport and storage*2	Ambient temperature: -40°C to +85°C (up to 24 V coil) -40°F to +185°F (up to 24 V coil) [-40°C to +70°C (48 V coil) -40°F to +158°F (48 V coil)]; Humidity: 5 to 85% R.H. (Not freezing and condensing at low temperature)	
	Max. operating speed (at rated load)	20 cpm	
Unit weight		Approx. 2 g .071 oz	

Notes: *1 This value can change due to the switching frequency, environmental conditions, and desired reliability level, therefore it is recommended to check this with the actual load. (AgPd contact type is available for low level load switching [10V DC, 10mA max. level])
*2 Refer to "AMBIENT ENVIRONMENT" in GENERAL APPLICATION GUIDELINES.

REFERENCE DATA

1. Maximum switching capacity

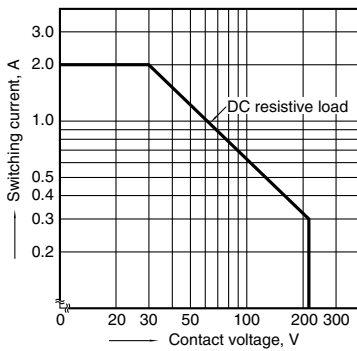

2. Life curve

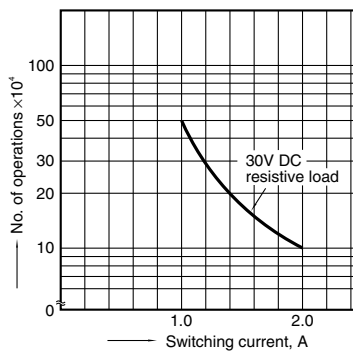

3. Mechanical life

Tested sample: TX2-5V, 10 pcs.
Operating speed: 180 cpm

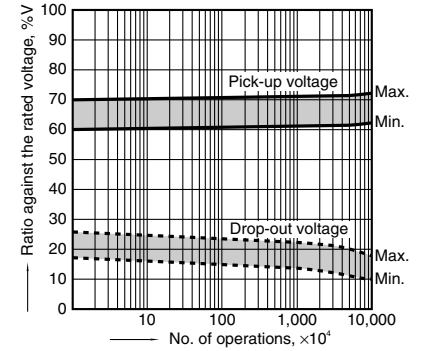

4. Electrical life (2A 30V DC resistive load)

Tested sample: TX2-5V, 6 pcs.
Operating speed: 20 cpm

Change of pick-up and drop-out voltage

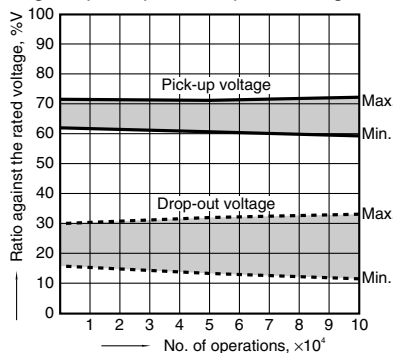

Change of contact resistance

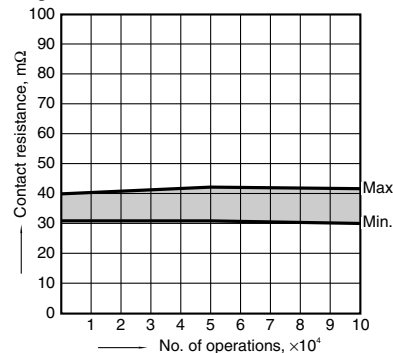

5. Coil temperature rise

Tested sample: TX2-5V, 6 pcs.
Point measured: Inside the coil
Ambient temperature: 25°C 77°F, 85°C 185°F

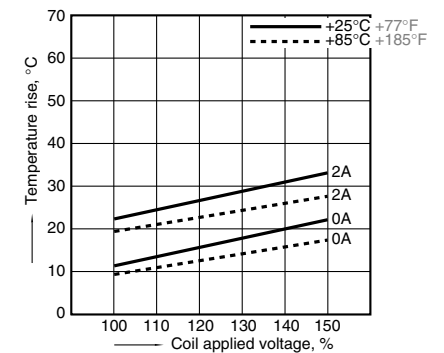

6-(1). Operate and release time (with diode)
Tested sample: TX2-5V, 10 pcs.

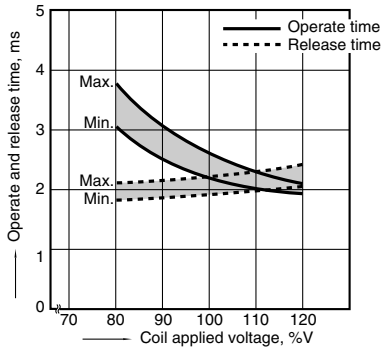

6-(2). Operate and release time (without diode)
Tested sample: TX2-5V, 10 pcs.

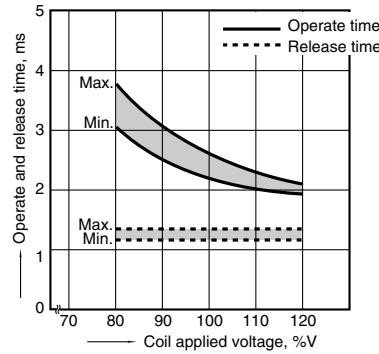

7. Ambient temperature characteristics
Tested sample: TX2-5V, 5 pcs.

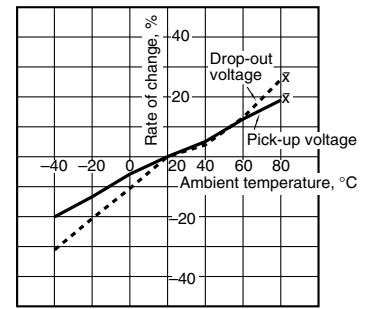

8-(1). High frequency characteristics (Isolation)
Tested sample: TX2-12V, 2 pcs.

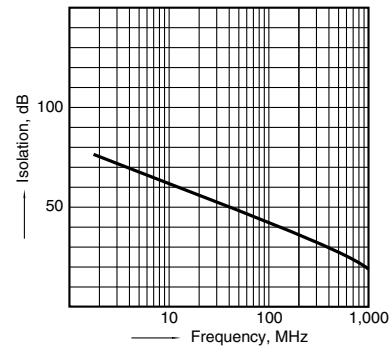

8-(2). High frequency characteristics (Insertion loss)
Tested sample: TX2-12V, 2 pcs.

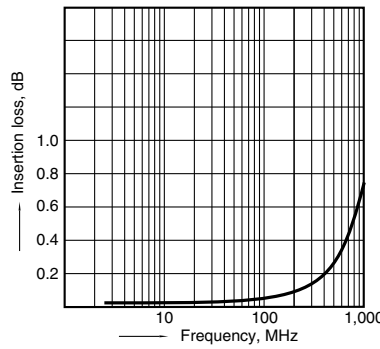

9. Malfunctional shock (single side stable)
Tested sample: TX2-5V, 6 pcs.

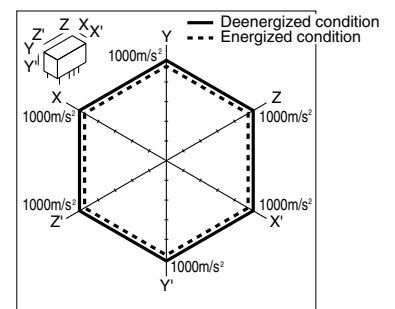

10-(1). Influence of adjacent mounting
Tested sample: TX2-12V, 6 pcs.

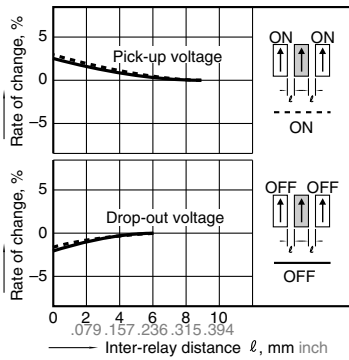

10-(2). Influence of adjacent mounting
Tested sample: TX2-12V, 6 pcs.

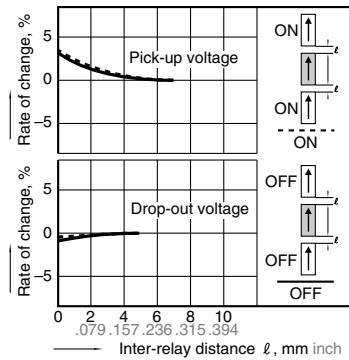

11. Pulse dialing test

Tested sample: TX2-5V, 6 pcs.
(35 mA 48 V DC wire spring relay load)

Circuit

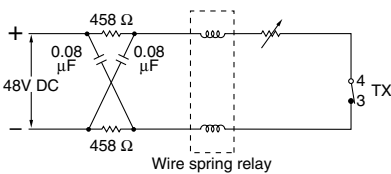

Change of pick-up and drop-out voltage

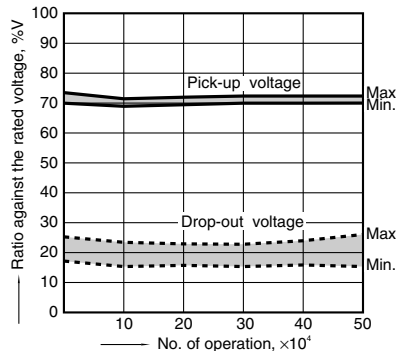

Change of contact resistance

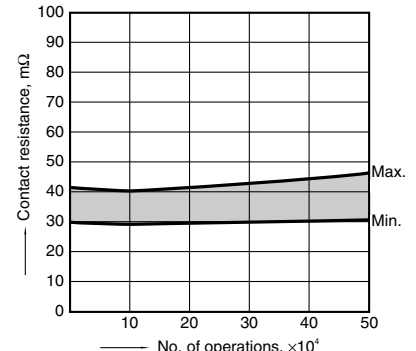

Note: Data of surface-mount type are the same as those of PC board terminal type.

DIMENSIONS (mm inch)

The CAD data of the products with a **CAD Data** mark can be downloaded from: <http://industrial.panasonic.com/ac/e/>

1. Standard PC board terminal and Self clinching terminal

CAD Data



Single side stable type
External dimensions
Standard PC board terminal

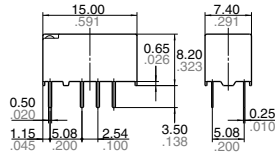

General tolerance: $\pm 0.3 \pm 0.12$

2 coil latching type
External dimensions
Standard PC board terminal

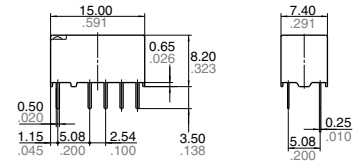

General tolerance: $\pm 0.3 \pm 0.12$

PC board pattern
(Bottom view)

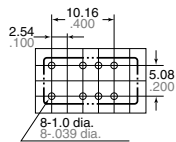

Tolerance: $\pm 0.1 \pm 0.004$

Schematic (Bottom view)
Single side stable

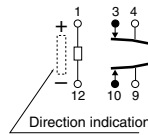

(Deenergized condition)

PC board pattern
(Bottom view)

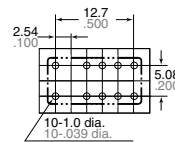

Tolerance: $\pm 0.1 \pm 0.004$

Schematic (Bottom view)
2 coil latching

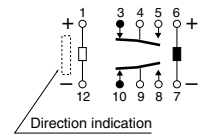

(Reset condition)

2. Surface-mount terminal

CAD Data



Type	External dimensions (General tolerance: $\pm 0.3 \pm 0.12$)		Suggested mounting pad (Top view) (Tolerance: $\pm 0.1 \pm 0.004$)	
	Single side stable type	2 coil latching type	Single side stable type	2 coil latching type
SA type				

Schematic (Top view)

Single side stable

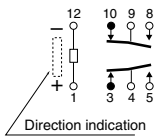

(Deenergized condition)

2 coil latching

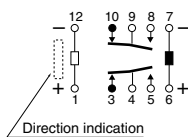

(Reset condition)

NOTES

1. Packing style

1) The relay is packed in a tube with the relay orientation mark on the left side, as shown in the figure below.

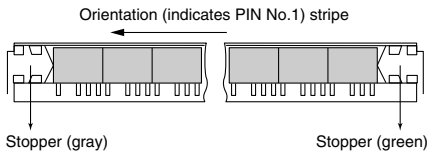

2) Tape and reel packing (surface-mount terminal type)

(1) Tape dimensions

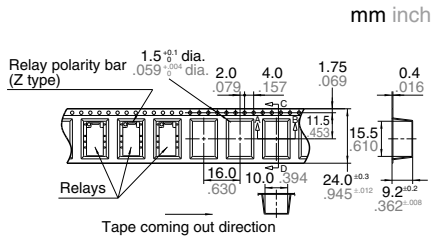

(2) Dimensions of plastic reel

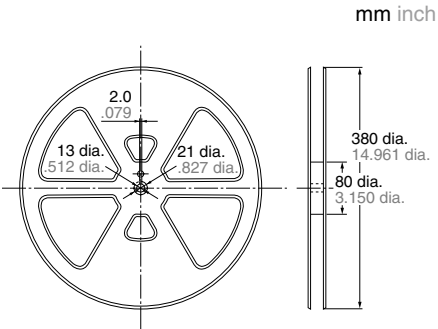

2. Automatic insertion

To maintain the internal function of the relay, the chucking pressure should not exceed the values below.

Chucking pressure in the direction A:
4.9 N {500gf} or less

Chucking pressure in the direction B:
9.8 N {1 kgf} or less

Chucking pressure in the direction C:
9.8 N {1 kgf} or less

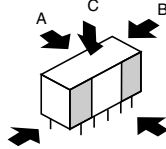

Please chuck the  portion.
Avoid chucking the center of the relay.
In addition, excessive chucking pressure to the pinpoint of the relay should be avoided.

For general cautions for use, please refer to the "Cautions for use of Signal Relays" or "General Application Guidelines".

Mouser Electronics

Authorized Distributor

Click to View Pricing, Inventory, Delivery & Lifecycle Information:

Panasonic:

[TX2-4.5V](#) [TX2-L2-5V](#) [TX2-5V](#) [TX2SA-5V](#) [TX2SA-5V-Z](#) [TX2-12V](#) [TX2SA-12V](#) [TX2-24V](#) [TX2SA-24V](#) [TX2SA-24V-Z](#) [TX2SA-12V-1](#) [TXS2SL-9V-1](#) [TX2SL-3V](#) [TX2-L-3V](#) [TX2-3V](#) [TX2SA-L2-3V](#) [TX2SA-3V](#) [TX2SA-L2-4.5V](#) [TX2SA-4.5V](#) [TX2SS-4.5V](#) [TX2-L-5V](#) [TX2-9V](#) [TX2SA-L2-5V](#) [TX2SL-5V](#) [TX2SA-L2-12V](#) [TX2SA-12V-Z](#) [TX2SL-24V](#) [TX2SS-24V](#) [TX2-48V](#) [TX2SS-48V](#) [TX2-L2-4.5V](#) [TX2-L2-9V](#) [TX2-L-4.5V](#) [TX2SL-4.5V](#) [TX2SA-9V](#) [TX2-L2-24V](#) [TX2-L2-12V](#) [TX2SS-5V](#) [TX2SL-12V](#) [TX2-LT-12V](#) [TX2-LT-24V](#) [TX2-LT-4.5V](#) [TX2SA-LT-12V](#) [TX2SA-LT-3V](#) [TX2SA-LT-4.5V](#) [TX2SA-LT-4.5V-Z](#) [TX2SA-LT-5V](#) [TX2SA-LT-5V-Z](#) [TX2SL-LT-3V](#) [TX2SL-LT-3V-X](#) [TX2SL-LT-4.5V](#) [TX2SA-LT-12V-Z](#) [TX2SA-3V-1](#) [TX2SA-LT-24V-Z](#) [TX2SS-LT-5V-Z](#) [TX2SA-LT-12V-X](#) [TX2-L-12V-1](#) [TX2SS-LT-12V-X](#) [TX2SS-LT-5V-X](#) [TX2SA-12V-1-X](#) [TX2SA-12V-1-Z](#) [TX2-L-9V-1](#) [TX2SA-3V-1-Z](#) [TX2SS-LT-12V-Z](#) [TX2SS-LT-3V](#) [TX2SA-3V-1-X](#) [TX2SS-LT-5V](#) [TX2SA-LT-3V-Z](#)