

Compact, Easy-to-read, Easy-to-use...
An electronic counter that's ahead of its time.



AEL51 systems (4-digit display)



AEL53 systems (6-digit display)



Pin type



Screw terminal type

Features

1. Bright and Easy-to-Read Display

A brand new bright 2-color backlight LCD display is easy-to-read in any location. Checking and setting is a cinch.

2. Simple Operation

Seesaw buttons make digit setting quick and easy.

3. Short Body of only 64.5 mm 2.54 inch (screw type) or 70.1 mm 2.76 inch (pin type)

With a short body, it easily installs in shallow control panels.

4. Conforms to IP66's Weather Resistant Standards

The water-proof panel keeps out water and dirt for reliable operation even in poor environments.

5. Screw terminal and Pin Type are Both Standard Configurations

The two terminal types are standard to support either front panel installation or embedded terminal block installation.

6. Changeable Panel Cover

Also offered with a black panel cover to meet your design considerations.

7. 4-digit or 6-digit display

Two display types are offered to fit your application needs.

8. Conforms With EMC and Low Voltage Directives

Conforms with EMC directives (EN50081-2/EN50082-2) and low-voltage directives (VDE0435/Part 2021) for CE certification vital for use in Europe.

9. Power Failure Memory Retention

The set value and displayed counts are retained in memory so no data is lost during a power failure.

Product types

Digit	Count speed	Operation mode	Output	Operation voltage	Terminal	Part No.
4	30 Hz (cps)/ 5 KHz (Kcps) switchable	Multi-mode (Direct-connect)	Relay (1c)	100-240 V AC	11 pin	LC4H-R4-AC240V
					Screw	LC4H-R4-AC240VS
				12-24 V DC	11 pin	LC4H-R4-DC24V
					Screw	LC4H-R4-DC24VS
			Transistor (1a)	100-240 V AC	11 pin	LC4H-T4-AC240V
					Screw	LC4H-T4-AC240VS
	12-24 V DC	11 pin	LC4H-T4-DC24V			
6			Relay (1c)	100-240 V AC	11 pin	LC4H-R6-AC240V
					Screw	LC4H-R6-AC240VS
				12-24 V DC	11 pin	LC4H-R6-DC24V
					Screw	LC4H-R6-DC24VS
			Transistor (1a)	100-240 V AC	11 pin	LC4H-T6-AC240V
					Screw	LC4H-T6-AC240VS
	12-24 V DC	11 pin	LC4H-T6-DC24V			
		Screw	LC4H-T6-DC24VS			

Part names

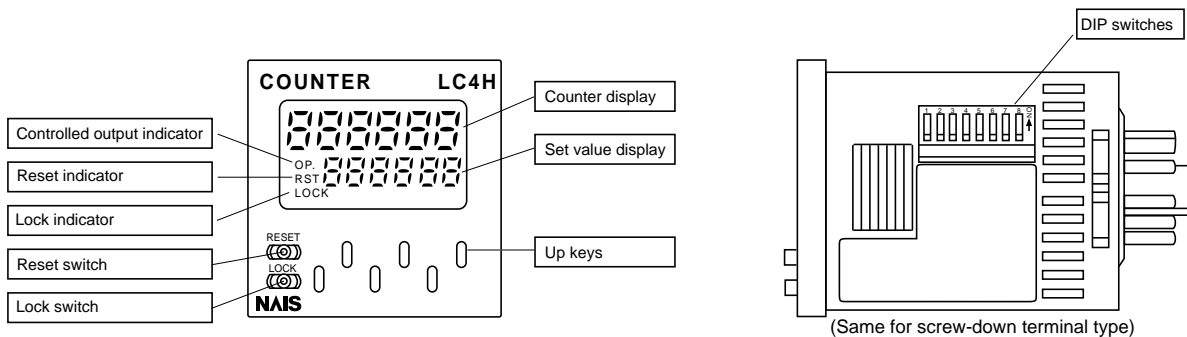
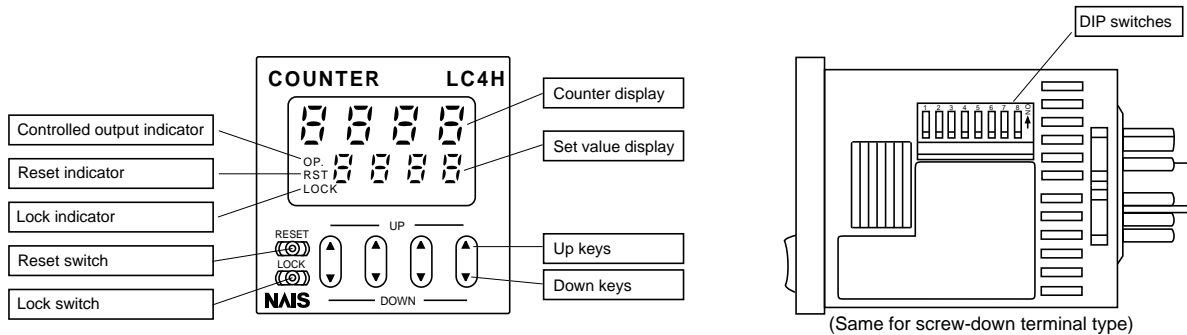

Specifications

Item	Relay output type		Transistor output type	
	AC type	DC type	AC type	DC type
Rated operating voltage	100 to 240 V AC	12 to 24 V DC	100 to 240 V AC	12 to 24 V DC
Rated frequency	50/60 Hz common	—	50/60 Hz common	—
Power consumption	Max. 10 V A	Max. 3 W	Max. 10 V A	Max. 3 W
Control output	1 Form C: 5 A, 250 V AC (resistive)		1 Form A: 100 mA, 30 V DC Open collector output (Max.)	
Input mode	Addition (UP)/Subtraction (DOWN)/Direction (DIR)/Independent (IND)/Phase (PHASE) 5 modes selectable by DIP switch			
Counting speed	30 cps/5 kcps (selectable by DIP switch)			
Min. counting input time	16.7 ms at 30 cps/0.1 ms at 5 kcps ON time: OFF time = 1:1			
Reset input method	Signal reset/Push-key switch, Min. input time 1 ms, 20 ms (selected by DIP switch)			
Lock input	Min. input signal width: 20 ms			
Input signal	Contact or Open collector input/Input impedance: 1 kΩ or less, Input residual voltage: 2 V or less, Open impedance: 100 kΩ or less, Max. energized voltage: 40 V DC			
Output mode	HOLD-A/HOLD-B/HOLD-C/SHOT-A/SHOT-B/SHOT-C/SHOT-D, 7 modes selectable by DIP switch			
One shot output time	Approx. 1 s			
Indication	7-segment LCD, Counter value (backlight red LED), Setting value (backlight yellow LED)			
Digit	4-digit display type -999 to 9999 (-3 digits to +4 digits) (0 to 9999 for setting) 6-digit display type -99999 to 999999 (-5 digits to 6 digits) (0 to 999999 for setting)			
Memory	EE-PROM (Overwriting times: 10 ⁵ ops. or more)			
Contact	1 Form C		1 Form A (Open collector)	
Initial contact resistance	100 mΩ (at 1 A 6 V DC)		—	
Contact material	Ag alloy/Au flush		—	
Life	2.0 × 10 ⁷ ops. (Except for switch operation parts)		—	
	Electrical 1.0 × 10 ⁵ ops. (At rated control voltage)		1.0 × 10 ⁷ ops. (At rated control voltage)	
Electrical	Operating voltage range 85 to 110 % of rated operating voltage			
	Initial withstand voltage		Initial withstand voltage	
	Between live and dead metal parts: 2,000 Vrms for 1 min (pin type) Between input and output: 2,000 Vrms for 1 min Between open contacts: 1,000 Vrms for 1 min		Between live and dead metal parts: 2,000 Vrms for 1 min Between input and output: 2,000 V AC for 1 min	
	Initial insulation resistance (At 500 V DC)		Initial insulation resistance (At 500 V DC)	
Between live and dead metal parts: Min. 100 MΩ (pin type) Between input and output: Min. 100 MΩ Between open contact: Min. 100 MΩ		Between live and dead metal parts: Min. 100 MΩ (pin type) Between input and output: Min. 100 MΩ		
Temperature rise Max. 65° C (under the flow of nominal operating current at nominal voltage)				
Mechanical	Vibration resistance	Functional	10 to 55 Hz (1 cycle/min), single amplitude: 0.35 mm .014 inch (10 min on 3 axes)	
		Destructive	10 to 55 Hz (1 cycle/min), single amplitude: 0.75 mm .030 inch (1 h on 3 axes)	
	Shock resistance	Functional	Min. 98 m 321.522 ft./s ² (4 times on 3 axes)	
		Destructive	Min. 294 m 964.567 ft./s ² (5 times on 3 axes)	
Operating conditions	Ambient temperature -10° C to 55° C +14° F to +131° F			
	Ambient humidity Max. 85 % RH			
	Air pressure 860 to 1,060 h Pa			
	Ripple rate —			
Connection		11-pin/screw terminal		
Protective construction		IP66 (front panel with a rubber gasket)		

Dimensions (units: mm inch)

• LC4H electronic counter

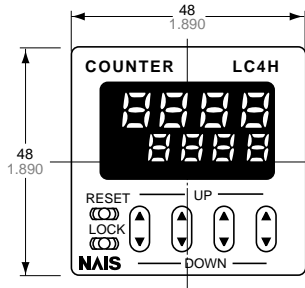

Screw-down terminal type (through-panel installation)

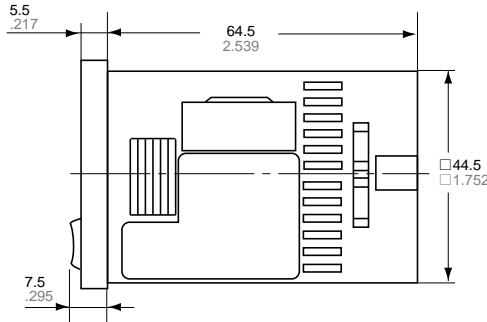

Pin type (embedded terminal block installation/through-panel installation)

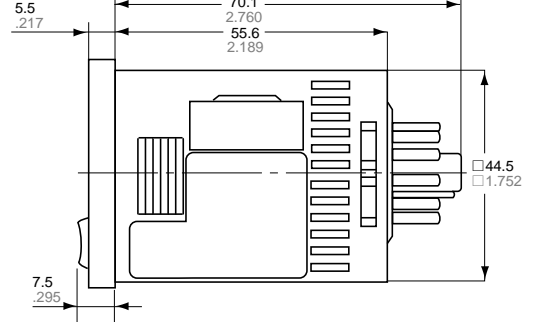

Screw-down terminal type (through-panel installation)

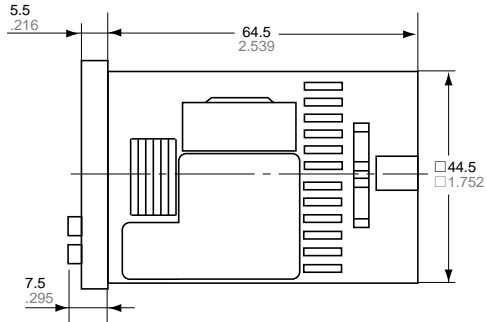
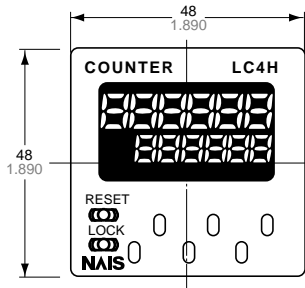

Pin type (embedded terminal block installation/through-panel installation)

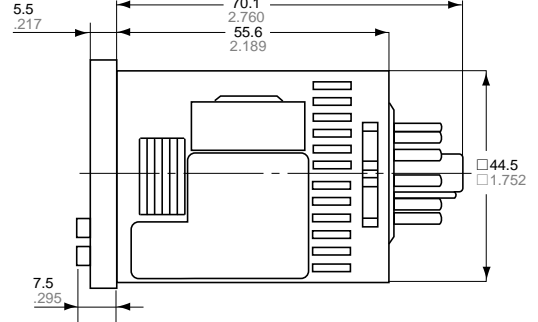

• Dimensions for through-panel installation (with adapter installed)

Screw-down terminal type

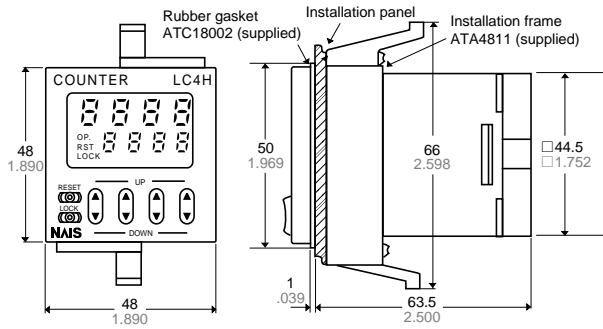

Pin type

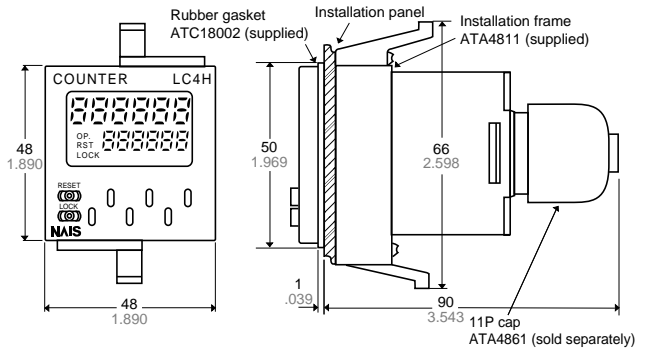

• Dimensions for terminal block installations

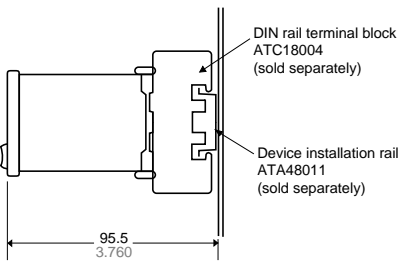

• Installation panel cut-out dimensions

The standard panel cut-out dimensions are shown below. Use the installation frame (ATA4811) and rubber gasket (ATC18002).

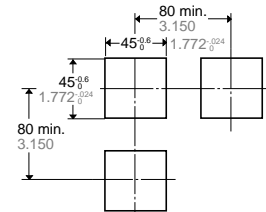

• For connected installations

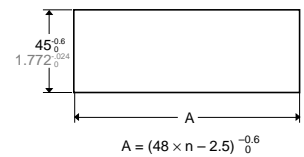

Note 1: The installation panel thickness should be between 1 and 5 mm .039 and .197 inch.
 Note 2: For connected installations, the waterproofing ability between the unit and installation panel is lost.

Terminal layout and wiring

• Pin type

Relay output type

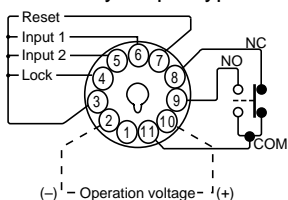

Transistor output type

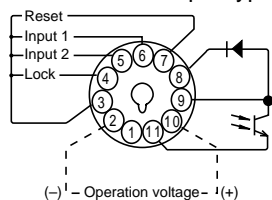

• Screw-down terminal type

Relay output type

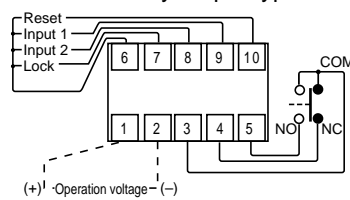

Transistor output type

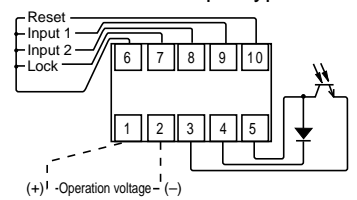

Setting the operation mode and count speed

Setting procedure 1) Operation mode (input mode and output mode)

Set the input and output modes with the DIP switches on the side of the unit.

DIP switches

Item	DIP switch		
	OFF	ON	
1	Refer to table 1		
2			
3			
4	Minimum reset input signal width	20 ms	1 ms
5	Maximum counter setting	30 Hz	5 kHz
6	Refer to table 2		
7			
8			

Table 1: Setting the output mode

DIP switch No.			Output mode
1	2	3	
ON	ON	ON	SHOT-A
OFF	OFF	OFF	SHOT-B
ON	OFF	OFF	SHOT-C
OFF	ON	OFF	SHOT-D
ON	ON	OFF	HOLD-A
OFF	OFF	ON	HOLD-B
ON	OFF	ON	HOLD-C
OFF	ON	ON	—

See note 1

Table 2: Setting the input mode

DIP switch No.			Input mode
6	7	8	
ON	ON	ON	Addition input
OFF	OFF	OFF	Subtraction input
ON	OFF	OFF	Direction input
OFF	ON	OFF	Independent input
ON	ON	OFF	Phase input
OFF	OFF	ON	—
ON	OFF	ON	—
OFF	ON	ON	—

See note 1

See note 1

See note 1

Note 1: The counter and set value displays will display DIP Err.

Note 2: Set the DIP switches before installing the unit.

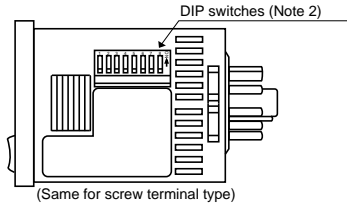

Setting procedure 2) Set value

Set the set value with the keys on the front of the unit.

Front display section

- ① Counter display
 - ② Set value display
 - ③ Controlled output indicator
 - ④ Reset indicator
 - ⑤ Lock indicator
 - ⑥ UP keys
- Increases the value of the corresponding digit of the set value display

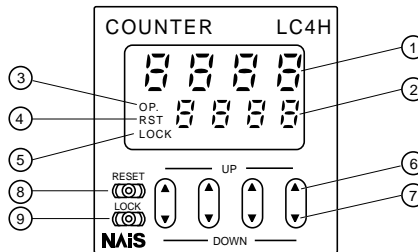

- ⑦ DOWN keys
- Decreases the value of the corresponding digit of the set value display
- ⑧ RESET switch
- Resets the set value and the output
- ⑨ LOCK switch
- Locks the operation of all keys on the unit

- ① Counter display
- ② Set value display
- ③ Controlled output indicator
- ④ Reset indicator
- ⑤ Lock indicator

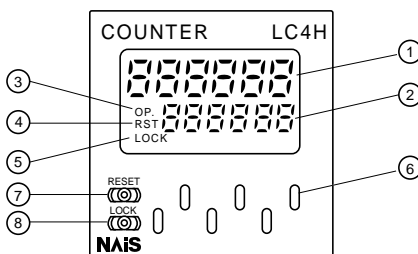

- ⑥ UP keys
- Increases the value of the corresponding digit of the set value display
- ⑦ RESET switch
- Resets the set value and the output
- ⑧ LOCK switch
- Locks the operation of all keys on the unit

• Changing the set value

1. It is possible to change the set value with the up and down keys (4-digit type only) even during counting. However, be aware of the following points.

1) If the set value is changed to less than the count value with counting set to the addition direction, counting will continue until it reaches full scale (9999 with the 4-digit type and 999999 with the 6-digit type), returns to zero, and then reaches the new set value. Resetting the counter will immediately return the display to zero. If the set value is changed

to a value above the count value, counting will continue until the count value reaches the new set value.

2) If counting is set to the subtraction direction, counting will continue until full scale (-999 with the 4-digit type and -99999 with the 6-digit type) regardless of the new set value, and then the display will change to - - - - with the 4-digit type and - - - - - - with the 6-digit type.

2. If the set value is changed to "0," the unit will not complete count-up. However, be aware of the following points.

1) When counting is set to the addition direction, counting will continue until full scale is reached (9999 with the 4-digit type and 999999 with the 6-digit type), return to zero, and then complete count-up.

2) When counting is set to the subtraction direction, counting will continue until full scale is reached (-999 with the 4-digit type and -99999 with the 6-digit type), and then the display will change to - - - - with the 4-digit type and - - - - - - with the 6-digit type.

Operation mode

1. Input mode

For the input mode, you can choose one of the following five modes

- Addition UP
- Subtraction DOWN
- Directive DIR
- Independent IND
- Phase PHASE

Input mode	Operation	*Minimum input signal width: 16.7 ms; 5 kHz: 0.1 ms
Addition UP	IN1 or IN2 works as an input block (gate) for the other input.	<p>• Example where IN1 is the count input and IN2 is the input block (gate).</p> <p>Counting (addition) 0 1 2 3 --- n-3 n-2 n-1 n</p> <p>Counting (subtraction) n n-1 n-2 n-3 --- 3 2 1 0</p> <p>△ Reset △ Count-up completed</p>
Subtraction DOWN		<p>• Example where IN2 is the count input and IN1 is the input block (gate).</p> <p>Counting (addition) 0 1 2 3 4 --- n-1 n</p> <p>Counting (subtraction) n n-1 n-2 n-3 n-4 --- 1 0</p> <p>△ Reset △ Count-up completed</p> <p>* "A" must be more than the minimum input signal width.</p>
Direction DIR	IN1 is the count input and IN2 is the addition or subtraction directive input. IN2 adds at L level and subtracts at H level.	<p>Counting 0 1 2 3 4 3 2 1 0 1 2 3 4</p> <p>△ Reset</p> <p>* "A" must be more than the minimum input signal width.</p>
Independent IND	IN1 is addition input and IN2 is subtraction input.	<p>Counting 0 1 2 3 4 3 2 1 2 1 2 3</p> <p>△ Reset</p> <p>* IN1 and IN2 are completely independent, so there is no restriction on signal timing.</p>
Phase PHASE	Addition when the IN1 phase advances beyond IN2, and subtraction when the IN2 phase advances beyond IN1.	<p>Counting 0 1 2 3 2 1 0</p> <p>△ Reset</p> <p>* "B" must be more than the minimum input signal width.</p>

2. Output mode

For the output mode, you can choose one of the following seven modes

- Maintain output/hold count HOLD-A
- Maintain output/over count I HOLD-B
- Maintain output/over count II HOLD-C
- One shot/over count SHOT-A
- One shot/recount I SHOT-B
- One shot/recount II SHOT-C
- One shot/hold count SHOT-D

Operation mode	Operation	(Example when input mode is either addition or subtraction)
Maintain output Hold count HOLD-A	Output control is maintained after count completion and until reset. During that time, the count display remains at the completed value. Additional inputs are ignored.	Counting (addition) ----- n-3 n-2 n-1 n Counting (subtraction) ----- 3 2 1 0 Counting able/unable ← Able → Unable → Output control OFF ON * n: Set value
Maintain output Over count I HOLD-B	Output control is maintained after count completion and until reset. However, the count display will continue to increase/decrease with additional inputs.	Counting (addition) ----- n-2 n-1 n n+1 n+2 ----- Counting (subtraction) ----- 2 1 0 -1 -2 ----- Counting able/unable ← Able → Output control OFF ON * n: Set value
Maintain output Over count II HOLD-C	Output control transfers and is maintained for one count period after count completion. However, the count display will continue to increase/decrease with additional inputs.	Counting (addition) ----- n-2 n-1 n n+1 n+2 ----- Counting (subtraction) ----- 2 1 0 -1 -2 ----- Counting able/unable ← Able → Output control OFF ON OFF * n: Set value
One shot Over count SHOT-A	Output control transfers and is maintained after count completion for a fixed time (approx. 1 sec). Counting continues with additional inputs.	Counting (addition) ----- n-2 n-1 n n+1 n+2 ----- Counting (subtraction) ----- 2 1 0 -1 -2 ----- Counting able/unable ← Able → Output control OFF ON OFF * n: Set value Approx. 1 s
One shot Recount I SHOT-B	Output control transfers and is maintained after count completion for a fixed time (approx. 1 sec). Counting continues with additional inputs. However, reset occurs simultaneous with completion of count. While output is being maintained, another count completion is not possible.	Counting (addition) ----- n-2 n-1 0 1 2 ----- Counting (subtraction) ----- 2 1 n n-1 n-2 ----- Counting able/unable ← Able → Output control OFF ON OFF * n: Set value Approx. 1 s △ Reset (automatic)
One shot Recount II SHOT-C	Output control transfers and is maintained after count completion for a fixed time (approx. 1 sec). Counting continues with additional inputs. However, reset occurs simultaneous with output OFF.	Counting (addition) ----- n-1 n n+1 0 1 ----- Counting (subtraction) ----- 1 0 -1 n n-1 ----- Counting able/unable ← Able → Output control OFF ON OFF * n: Set value Approx. 1 s △ Reset (automatic)
One shot Hold count SHOT-D	Output control transfers and is maintained after count completion for a fixed time (approx. 1 sec). During output ON, the count display does not change from that at count completion. Reset occurs simultaneous with output OFF.	Counting (addition) ----- n-1 n 0 1 ----- Counting (subtraction) ----- 1 0 n n-1 ----- Counting able/unable ← Able → Unable → Able → Output control OFF ON OFF * n: Set value Approx. 1 s △ Reset (automatic)

Precautions during usage

1. Terminal wiring

1) When wiring the terminals, refer to the terminal layout and wiring diagrams and be sure to perform the wiring properly without errors.

2) For embedded installation applications, the screw-down terminal type is recommended. When using the pin type, use the 11P cap (ATA4861). Do not solder directly to the unit's round pins. For front panel installation applications, use the 11-pin type DIN rail terminal block (ATC18004).

3) After turning the unit off, make sure that any resulting induced voltage or residual voltage is not applied to power supply terminals 2 through 10 (pin type) or 1 and 2 (screw-down terminal type). (If the power supply wire is wired parallel to the high voltage wire or power wire, an induced voltage may be generated between the power supply terminals.)

4) Have the power supply voltage pass through a switch or relay so that it is applied at one time. If the power supply is applied gradually, the counting may malfunction regardless of the settings, the power supply reset may not function, or other such unpredictable occurrence may result.

2. Input and output

1) Signal input type

(1) Contact point input

Use highly reliable metal plated contacts. Since the contact point's bounce time leads directly to error in the count value, use contacts with as short a bounce time as possible. In general, select Input 1 and Input 2 to have a maximum counting speed of 30 Hz and to be reset with a minimum input signal

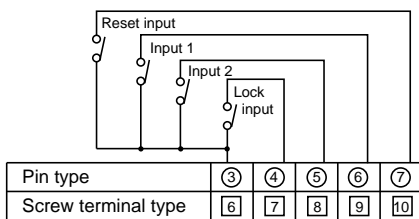

width of 20 ms.

(2) Non-contact point input

Connect with an open collector. Use transistors whose characteristics satisfy the criteria given below.

$V_{CE0} = 20\text{ V min.}$

$I_c = 20\text{ mA min.}$

$I_{CBO} = 6\mu\text{A max.}$

Also, use transistors with a residual voltage of less than 2 V when the transistor is on.

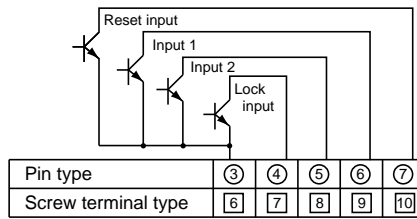

* The short-circuit impedance should be less than 1 k Ω .

[When the impedance is 0 Ω , the current coming from the input 1 and input 2 terminals is approximately 12 mA, and from the reset input and lock input terminals is approximately 1.5 mA.]

Also, the open-circuit impedance should be more than 100 k Ω .

* As shown in the diagram below, from a non-contact point circuit (proximity switches, photoelectric switches, etc.) with a power supply voltage of between 12 and 40 V, the signal can be input without using an open collector transistor. In the case of the diagram below, when the non-contact point transistor Q switches from off to on (when the signal voltage goes from high to low), the signal is input.

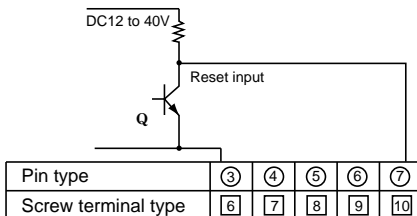

(The above example is for reset input)

2) The input mode and output mode change depending on the DIP switch settings. Therefore, before making any connections, be sure to confirm the operation mode and operation conditions currently set.

3) For the power supply of the input device, use a single-phase or double-phase insulated power transformer. The second-phase side must not be grounded.

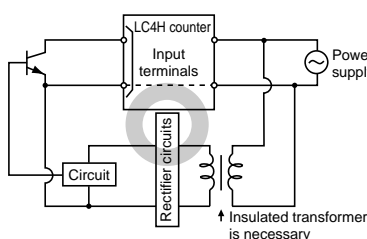

4) Since the power supply circuitry does not contain a transformer, be aware that it is not possible for simultaneous input from an input contact point or transistor to a LC4H counter with independent power supply operation.

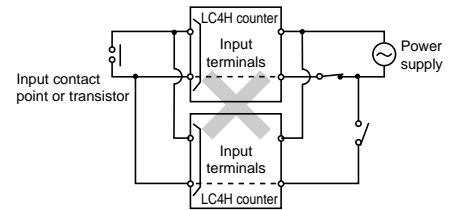

5) The input signal is applied by the shorting of each input terminal with the common terminal (terminal 3 for pin types, and terminal 6 for screw-down terminal types). Never connect other terminals or voltages higher than DC 40 V, because it may destroy the internal circuitry.

6) Transistor output

(1) Since the transistor output is insulated from the internal circuitry by a photocoupler, it can be used as an NPN output or PNP (equal value) output.

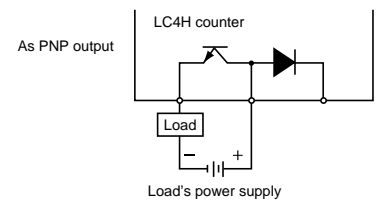
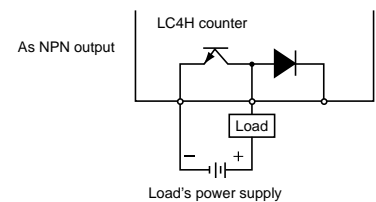

(2) Use the diode connected to the output transistor's collector for absorbing the reverse voltage from induced loads.

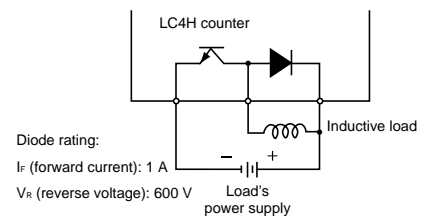

7) When wiring, use shielded wires or metallic wire tubes, and keep the wire lengths as short as possible.

8) For the load of the controlled output, make sure that it is lower than the rated control capacity.

3. Conditions of usage

- 1) Avoid locations subject to flammable or corrosive gases, excessive dust, oil, vibrations, or excessive shocks.
- 2) Since the cover of the unit is made of polycarbonate resin, avoid contact with or use in environments containing methyl alcohol, benzene, thinners, and other organic solvents; and ammonia, caustic sodas, and other alkaline substances.
- 3) If power supply surges exceed the values given below, the internal circuits may become damaged. Be sure to use surge absorbing element to prevent this from happening.

Operating voltage	Surge voltage (peak value)
AC type	6,000V
DC type	1,000V

• Surge wave form

[± (1.2 × 50) ms uni-polar full wave voltage]

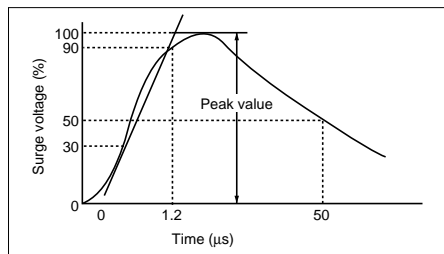

- 4) Regarding external noise, the values below are considered the noise-resistant voltages. If voltages rise above these values, malfunctions or damage to the internal circuitry may result, so take the necessary precautions.

	Power supply terminals		Input terminals
	AC type	DC type	
Noise voltage	1,500V	1,000V	600V

Noise wave form (noise simulator)

Rise time: 1 ns

Pulse width: 1 ms, 50 ns

Polarity: ±

Cycle: 100 cycles/second

- 5) When connecting the operation power supply, make sure that no leakage current enters the counter. For example, when performing contact protection, if set up like that of diagram A, leaking current will pass through C and R, enter the unit, and cause incorrect operation. Diagram B shows the correct setup.

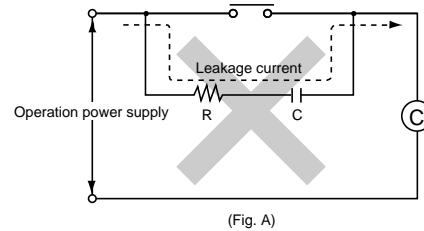

(Fig. A)

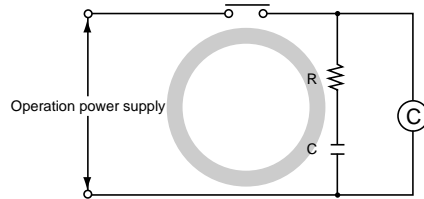

(Fig. B)

- 6) Long periods of continuous operation in the count-up completed condition (one month or more) will result in the weakening of the internal electrical components from the generated heat and, therefore, should be avoided. If you do plan to use the unit for such continuous operation, use in conjunction with a relay as shown in the circuit in the diagram below.

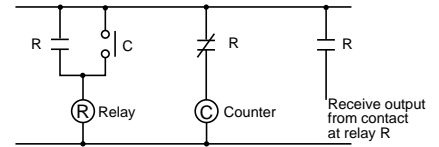

4. Self-diagnosis function

If a malfunction occurs, one of the following displays will appear.

Display	Contents	Output condition	Restoration procedure	Preset values after restoration
- - - - or - - - - -	Minimum value went below -999 or -99999. See note 1.	No change	Enter reset or RESET key.	No change
IPFt	Incorrect DIP switch setting.		Restart unit (correct DIP switch settings)	
Et - 00	Malfunctioning CPU.	OFF	Enter reset, RESET key, or restart unit.	The values at start-up before the CPU malfunction occurred.
Et - 01	Malfunctioning memory. See note 2.			0

Note 1: When the counter value goes below the minimum value during any of the subtraction, directive, independent, or phase input modes.

Note 2: Includes the possibility that the EEPROM's life has expired.

5. CE Marking Certification

1) EMC directive (89/336/EEC)

As a counter unit, the LC4H series conforms to EMC directives. Applicable standards are EN50081-2 and EN50082-2.

2) Low voltage directive (73/23/EEC)

In order to satisfy VDE0435/Part 2021, be sure to adhere to the following installation conditions and precautions.

- (1) The counter uses a non-transformer power supply and the power supply and input signal terminals are not insulated.

• When a sensor is connected to the

input circuit, install double insulation on the sensor side.

- With contact-point inputting, use double-insulated relays, etc.

(2) Always connect loads insulated with basic insulation specifications to the output contact points. The counter unit is also insulated with basic insulation specifications. The combination of the two satisfies VDE, which calls for double insulation.

(3) For the applied power supply, use one protected by an over-current protec-

tion device that conforms with EN/IEC standards (i.e. 250 V, 1 A fuse).

(4) During installation, always use a terminal block or the appropriate sockets.

Do not touch the terminals, or other part of the counter unit while it is on. Before installation or removal of the unit, first verify that no voltage is being applied to any of the terminals.

(5) Do not use the counter in a safety circuit. When the unit is being used in a circuit such as a heater circuit, install a protection circuit on the machine side.

INSTALLATIONS

1. Surface mount

1) Use the pin type timer.

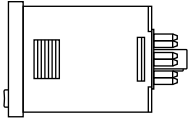

- 2) Put the terminal socket on the board directly or put it on the DIN rail (Fig. 1)
- 3) Insert the timer into the terminal socket and fix it with clip. (Fig. 2)
- 4) On DIN rail mounting, mount the timer on the DIN rail tightly.

(Fig. 1)

(Fig. 2)

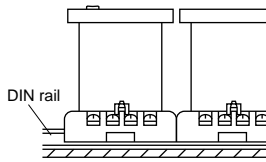
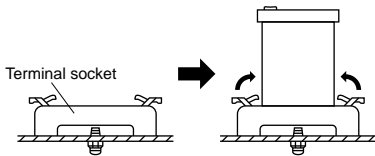

- 5) Pin type is connected with terminal socket ATC18004.
- 6) DIN rail (AT8-DLA1) is also available (1m).

2. Flush mount

- 1) Use the built-in screw terminal type for flush mount. (Mounting frame and rubber gasket are provided when timer is shipped.)
When the pin type is used, accessories (AT8-DA4 and ATC18002) are required.
- 2) Insert the timer into the panel cut and

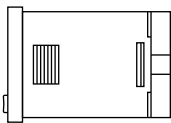

slide the mounting frame from the back. Push the mounting frame over the timer to tighten the screw. Fasten in place with the screws provided.

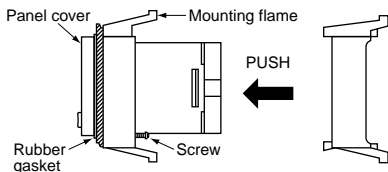

3) ① When the water-protected type is used, confirm the conditions with which timer with rubber gasket and panel are attached tightly.

② Mounting without panel cover and rubber gasket will be less water-resistant.

4) Loosen the screws on the mounting frame, spread the edge of frame and remove it.

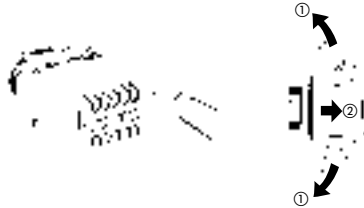

5) Refer to the terminal wiring diagram, wire the terminals correctly.

6) Panel cutout dimensions

The standard panel cutout dimensions are shown below. (Panel thickness: 1 to 5mm .039 to .197 inch)

7) Although the timers can be mounted adjacent to each other, it is recommended to arrange the mounting holes as shown in the figure to facilitate attaching and detaching the mounting frame.

When the front protective cover is used, cut a hole using these dimensions.

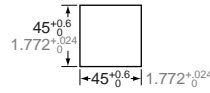

8) Adjacent mounting of PM4H timers can be accomplished. The front protective cover cannot be used for this type of mounting. (panel thickness: 1 to 5mm .039 to .197 inch)

The standard dimension for A when n units (n ≤ 5) are mounted adjacently.

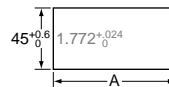
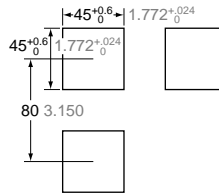

$$A = (48 \times n - 2.5)^{+0.6} \text{ (mm)}$$

$$A = (1.890 \times n - 2.5)^{+0.024} \text{ inch}$$

If six or more units are to be mounted, measure the actual dimensions and cut the panel accordingly.

When lining up the timers horizontally, set the frames in such a position so the formed spring areas are at the top and bottom.

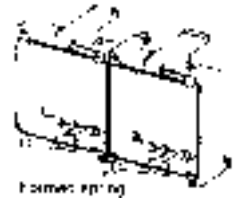

When lining up the timers vertically, set the frames in such a position as the formed spring areas are at the right and left.



MOUNTING PARTS

- Rubber gasket

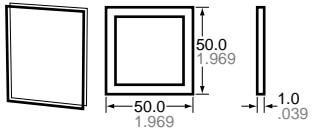

ATC18002

ACCESSORIES

- Panel cover (Black)



AEL58011



AEL58012