

**NOT RECOMMENDED FOR NEW DESIGNS T-37-21**

## PN Unijunction Transistors Silicon Unijunction Transistors

**2N4870  
2N4871**

... designed for pulse and timing circuits, sensing circuits, and thyristor trigger circuits. These devices feature:

- Low Peak Point Current — 1  $\mu$ A Typical
- Low Emitter Reverse Current — 5 nA Typical
- Passivated Surface for Reliability and Uniformity
- One-Piece Injection-Molded Unibloc<sup>®</sup> Plastic Package for Economy and Reliability
- High  $\eta$  for greater bandwidth

PN UJTs

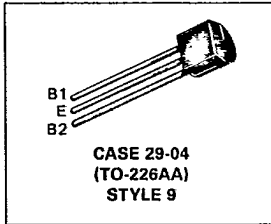
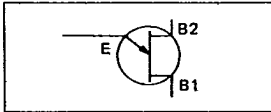

**MAXIMUM RATINGS** ( $T_A = 25^\circ$  unless otherwise noted.)

Rating	Symbol	Value	Unit
RMS Power Dissipation, Note 1	$P_D$	300	mW
RMS Emitter Current	$I_e$	50	mA
Peak-Pulse Emitter Current, Note 2	$I_e$	1.5	Amp
Emitter Reverse Voltage	$V_{B2E}$	30	Volts
Interbase Voltage, Note 3	$V_{B2B1}$	35	Volts
Operating Junction Temperature Range	$T_J$	-55 to +125	$^\circ$ C
Storage Temperature Range	$T_{stg}$	-55 to +150	$^\circ$ C

Notes: 1. Derate 3 mW/ $^\circ$ C increase in ambient temperature.  
 2. Duty cycle  $\leq$  1%, PRR = 10 PPS (see Figure 5).  
 3. Based upon power dissipation at  $T_A = 25^\circ$ C.

T-37-21

ELECTRICAL CHARACTERISTICS ( $T_A = 25^\circ\text{C}$  unless otherwise noted.)

Characteristic	Fig. No.	Symbol	Min	Typ	Max	Unit
Intrinsic Standoff Ratio, Note 1 ( $V_{B2B1} = 10\text{ V}$ )	4, 7	$\eta$	0.56 0.70	—	0.75 0.85	—
Interbase Resistance ( $V_{B2B1} = 3\text{ V}, I_E = 0$ )	10, 11	$R_{BB}$	4	6	9.1	k ohms
Interbase Resistance Temperature Coefficient ( $V_{B2B1} = 3\text{ V}, I_E = 0, T_A = -65\text{ to }+125^\circ\text{C}$ )	11	$\alpha R_{BB}$	0.10	—	0.90	%/°C
Emitter Saturation Voltage, Note 2 ( $V_{B2B1} = 10\text{ V}, I_E = 50\text{ mA}$ )		$V_{EB1}(\text{sat})$	—	2.5	—	Volts
Modulated Interbase Current ( $V_{B2B1} = 10\text{ V}, I_E = 50\text{ mA}$ )		$I_{B2}(\text{mod})$	—	15	—	mA
Emitter Reverse Current ( $V_{B2E} = 30\text{ V}, I_{B1} = 0$ )	6	$I_{EB20}$	—	0.005	1	$\mu\text{A}$
Peak-Point Emitter Current ( $V_{B2B1} = 25\text{ V}$ )	8, 9	$I_P$	—	1	5	$\mu\text{A}$
Valley-Point Current, Note 2 ( $V_{B2B1} = 20\text{ V}, R_{B2} = 100\text{ ohms}$ )	12, 13	$I_V$	2 4	5 7	—	mA
Base-One Peak Pulse Voltage	2N4870 2N4871	$V_{OB1}$	3 5	6 8	—	Volts

Notes: 1.  $\eta$ , Intrinsic standoff ratio, is defined in terms of the peak-point voltage,  $V_P$ , by means of the equation:  $V_P = \eta V_{B2B1} + V_F$ , where  $V_F$  is about 0.49 volt at  $25^\circ\text{C}$  ( $I_F = 10\ \mu\text{A}$  and decreases with temperature at about  $2.5\ \text{mV}/^\circ\text{C}$ ). The test circuit is shown in Figure 4. Components  $R_1, C_1$ , and the UJT form a relaxation oscillator; the remaining circuitry serves as a peak-voltage detector. The forward drop of Diode  $D_1$  compensates for  $V_F$ . To use, the "cal" button is pushed, and  $R_3$  is adjusted to make the current meter,  $M_1$ , read full scale. When the "cal" button is released, the value of  $\eta$  is read directly from the meter, if full scale on the meter reads 1.

2. Use pulse techniques:  $PW \approx 300\ \mu\text{s}$ , duty cycle  $\leq 2\%$  to avoid internal heating, which may result in erroneous readings.



FIGURE 1 — UNIJUNCTION TRANSISTOR SYMBOL AND NOMENCLATURE

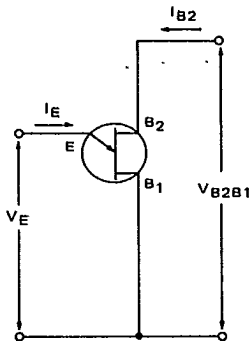
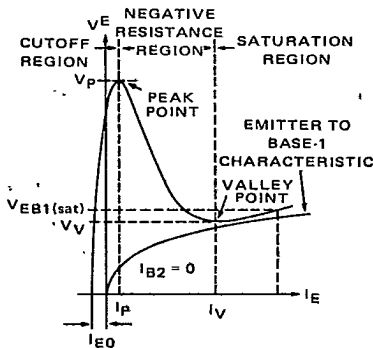

FIGURE 2 — STATIC EMITTER CHARACTERISTICS CURVES



T-37-21

FIGURE 3 -  $V_{OB1}$  TEST CIRCUIT

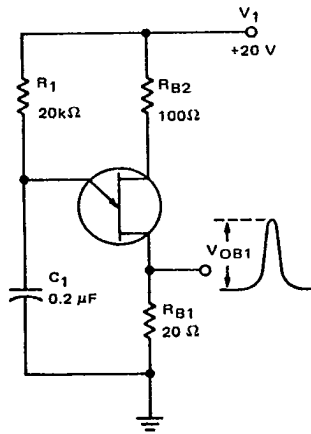

FIGURE 4 -  $\eta$  TEST CIRCUIT

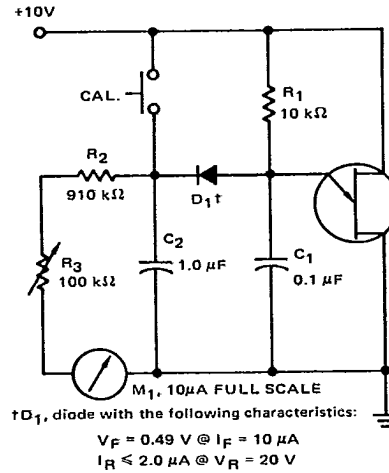
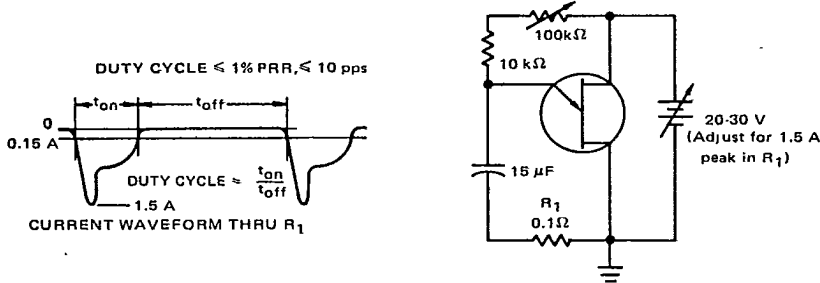

FIGURE 5 - PRR TEST CIRCUIT AND WAVEFORM



TYPICAL CHARACTERISTICS

FIGURE 6 - EMITTER REVERSE CURRENT

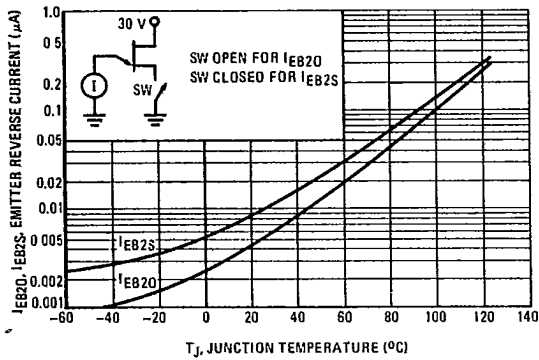
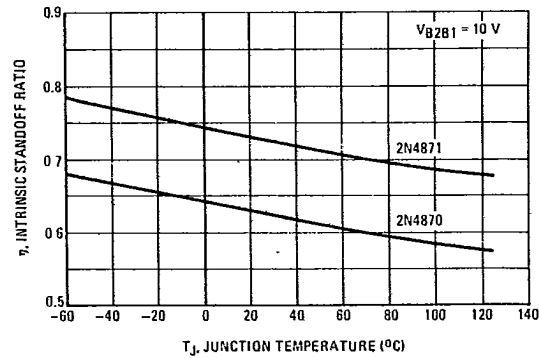

FIGURE 7 - INTRINSIC STANDOFF RATIO



2N4870 • 2N4871

T-37-21

PEAK POINT CURRENT

FIGURE 8 - EFFECT OF VOLTAGE

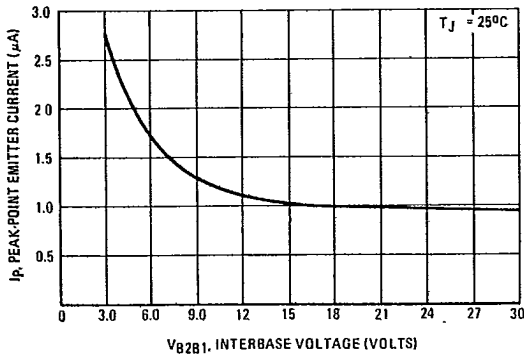
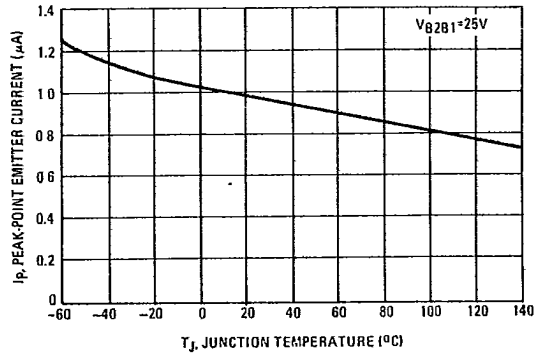

FIGURE 9 - EFFECT OF TEMPERATURE



INTERBASE RESISTANCE

FIGURE 10 - EFFECT OF VOLTAGE

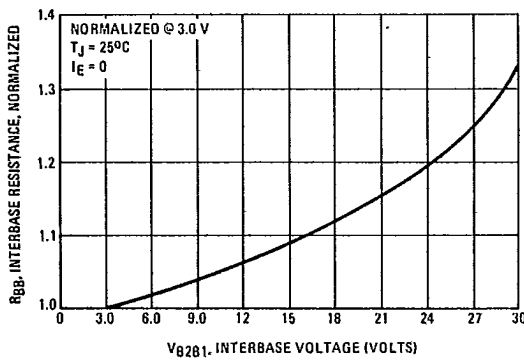
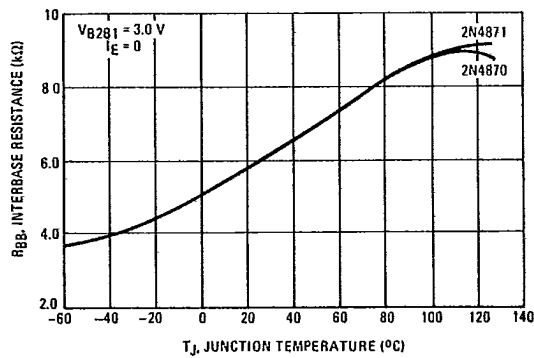

FIGURE 11 - EFFECT OF TEMPERATURE



TYPICAL CHARACTERISTICS

VALLEY CURRENT

FIGURE 12 - EFFECT OF VOLTAGE

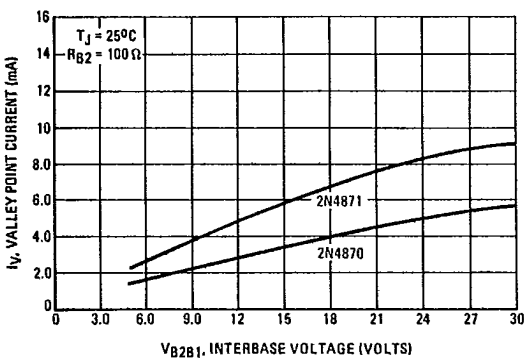
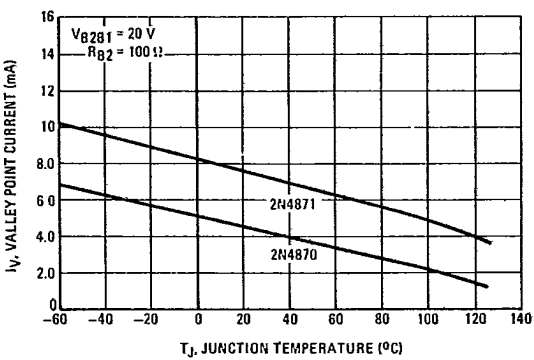

FIGURE 13 - EFFECT OF TEMPERATURE



2N4870 • 2N4871

T-37-21

VALLEY VOLTAGE

FIGURE 14 - EFFECT OF VOLTAGE

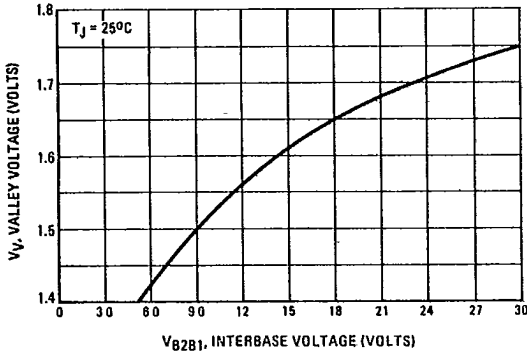

FIGURE 15 - EFFECT OF TEMPERATURE

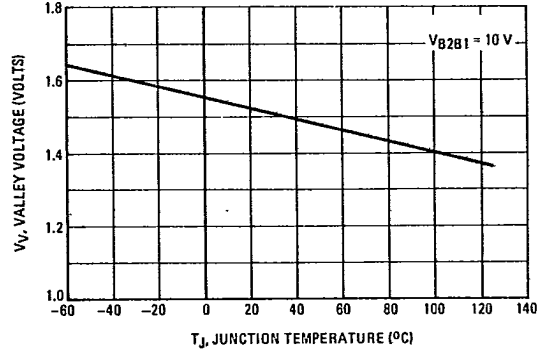

FIGURE 16 - OUTPUT VOLTAGE

