

1591B ENCLOSURE

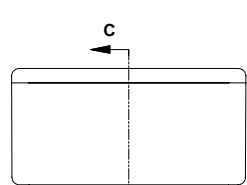

SIDE VIEW OF BOX

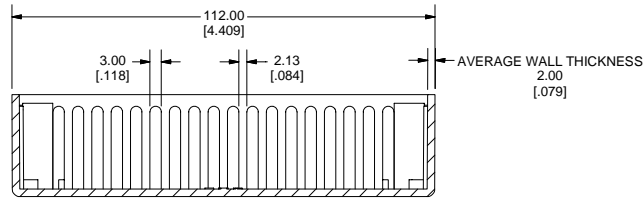
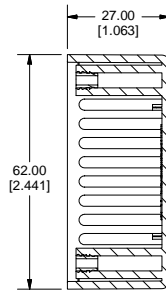
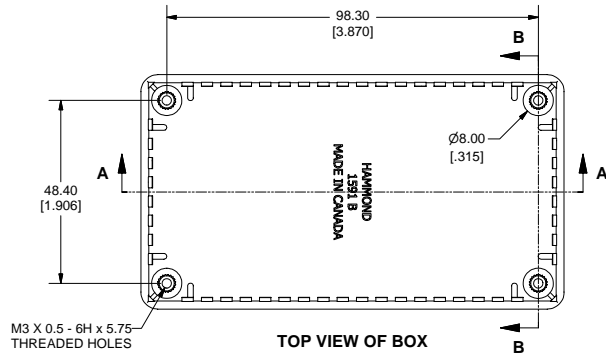

END VIEW OF ASSEMBLY

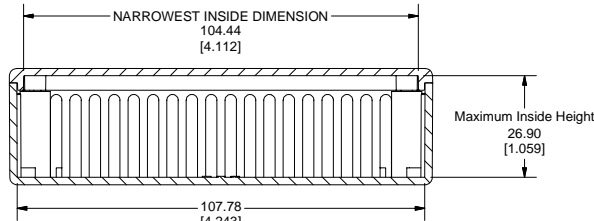

SECTION C-C

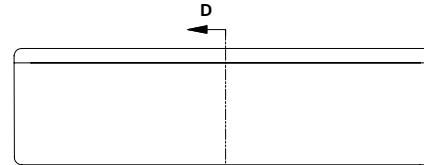

SIDE VIEW OF ASSEMBLY

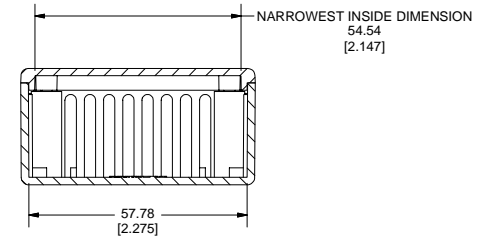

SECTION D-D

LID FASTENERS
M3 x 10 mm Screws for FRABS/Polycarb
#4 x 1/2" Self Tapping for GPABS

Brass Inserts in FRABS and Polycarb
No inserts in GPABS

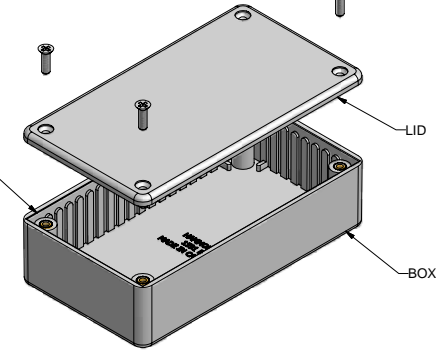

EXPLODED VIEW OF ENCLOSURE

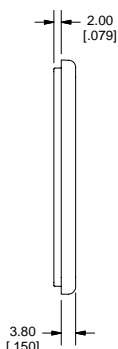

SIDE OF LID

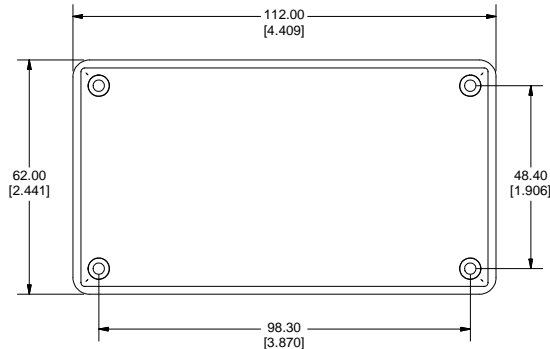

BOTTOM OF LID

Note:
Enclosures can be Factory Modified (Milling, Drilling, Printing etc.)
Solid models of this enclosure available in STEP or IGES Format.
Contact Factory mjm@hammondmfg.com



PART NUMBERS		
1591B Enclosures		
Material	Colour	Part Number
FR ABS UL94 - V0	Black	1591BBK
	Grey	1591BGV
	Black Shielded (Conductive Paint)	1591RBBK
GP ABS	Black	1591BSBK
	Grey	1591BSGY
	Ice Blue	1591BTBU
Translucent Polycarbonate	IR Red	1591BTRD
	Crystal Clear	1591BTCL
Accessories		
	Description	Part Number
Universal Application	PC Board Card Adapters	See Accessories Section
	Flange Kits	See Accessories Section
	Clear Lids - clear, flame retardant polycarbonate - Lid ONLY	1591BC
FR ABS & Polycarbonate	Replacement Screws, Flat head Phillips, Nickel Plated Pkg of 100	1591MS100 1591MS100BK (Black)
	Self Tapping Pkg of 100	1591TS100 1591TS100BK (Black)
Required Torque on Fasteners (no lubrication)		
	M3 - 0.5 x 10mm Screws	30-40 cN*m
	#4 x 0.5 Screws	30-40 cN*m