

S and SF series

Washable miniature toggle switches

Distinctive features and specifications

UG1006-A

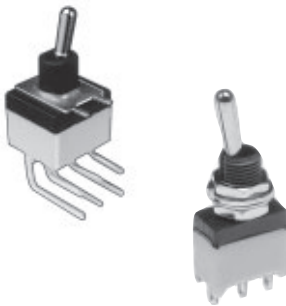

- Sealed**
 - Secure assembly of the two case parts
 - Internally sealed bushing
 - Epoxy sealed terminals
- Process compatible (S series)**
 - Wave solderable
 - Washable
- Optional ESD protection**

ELECTRICAL SPECIFICATIONS

- Max. current/voltage rating with resistive load :
 - silver contacts (A or 1) : 2A 250VAC - 5A 125VAC - 4A 30VDC
 - gold plated brass contacts (CD or 0) : 0,4VA 20VAC or DC
 - gold plated silver contacts (AD or 2) : 2A 250VAC - 5A 125VAC - 4A 30VDC (300mA 30VDC for gold plating)
- Initial contact resistance : 10 mΩ max.
- Insulation resistance : 1.000 MΩ min.
- Dielectric strength : 1.000 Vrms 50 Hz min.
- Electrical life at full load :

Contacts	Number of cycles	
	2 positions	3 positions
A or 1	40.000	40.000
CD or 0	100.000	50.000
AD or 2	40.000	40.000

MATERIALS

- Case and cover : UL94-VO, polyamide, glass filled or PES
- Actuator : brass, nickel plated
- Contacts
 - CD or 0** : brass, gold plated
 - A or 1** : silver
 - AD or 2** : silver, gold plated
- Terminal seal : epoxy

GENERAL SPECIFICATIONS

- Mechanical strength :
Terminals are strengthened by a bracket or a ground plate ensuring the rigidity of the switch on the board.
Actuator strength is 10N max.
- Operating temperature : -20°C to +85°C
- Storage temperature : -40°C to +85°C
- Moisture :
The insulating materials employed and the complete seal permit the switches to withstand a 56 days moisture test (IEC 68-2-3).
- Soldering - thermal shock (S series only) :
The switches are especially designed for flow soldering at 260°C during 5 seconds owing to high temperature polymer parts.
- Iron soldering (SF series) : 300°C 5 sec. max.
- Solderability : The switches are tested at 235°C according to IEC 68-2-20 after accelerated aging.

AGENCY APPROVALS



CECC 96201-006

Availability : consult factory for details of approved models.

Marking : to order switches marked UL or CECC, complete appropriate box of ordering format.

S series

Washable toggle switches - plain bushing

Overview

MODEL
STRUCTURE

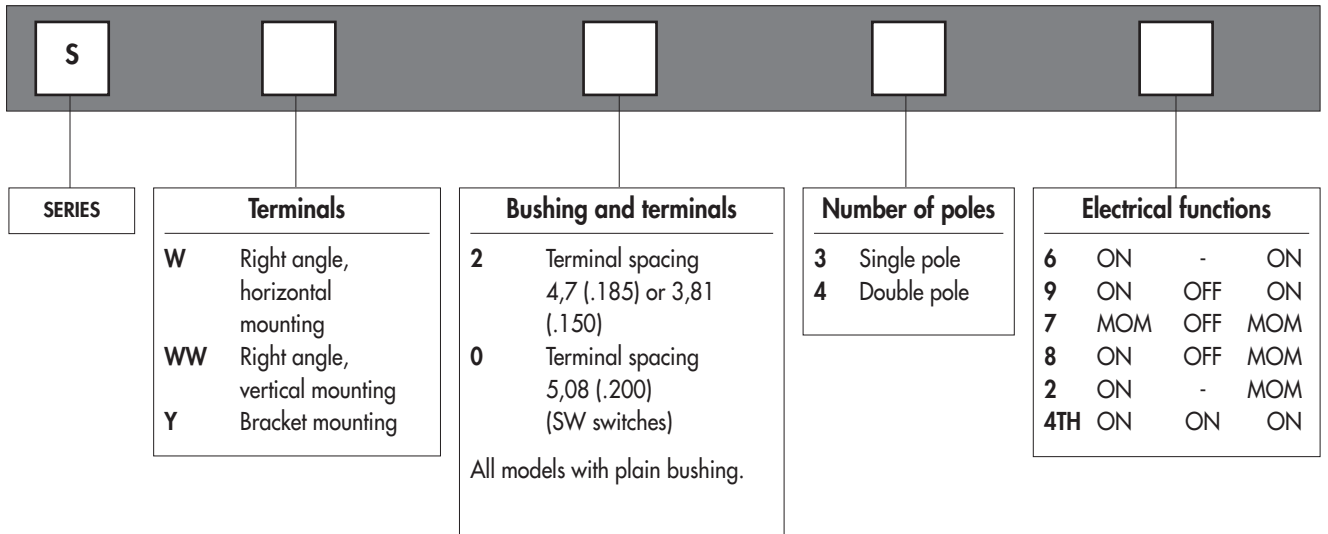

OPTIONS

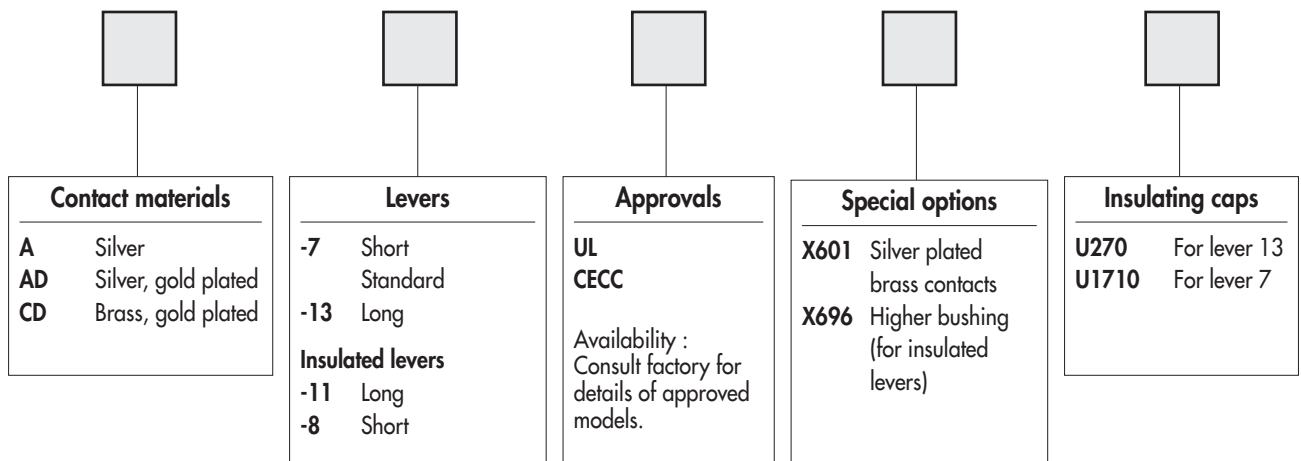

ABOUT THIS SERIES

On the following pages, you will find successively :

- model structure of switches
- options in the same order as above

Dimensions : first dimensions are in mm while inches are shown as bracketted numbers.



NOTICE : please note that not all combinations of above numbers are available. Refer to the following pages for further information.



Packaging unit : 50 or 25 pieces depending on model.

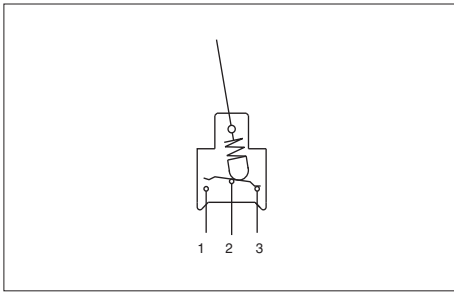

- Straight PC or right angle terminals
- Terminal spacing 4,7 (.185) or 5,08 (.200) on SW switches
- 1 and 2 pole configurations

MODEL STRUCTURE



Shown with lever (-7)

Right angle terminals - horizontal - spacing 4,7 (.185)

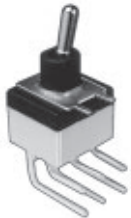

Single pole Double pole

SW236	SW246
SW239	SW249
SW237	SW247
SW238	SW248
SW232	SW242
	SW244TH*

III	II	I
2-3		2-1
5-6		4-5
ON	-	ON
ON	OFF	ON
MOM	OFF	MOM
ON	OFF	MOM
ON	-	MOM
ON	ON	ON

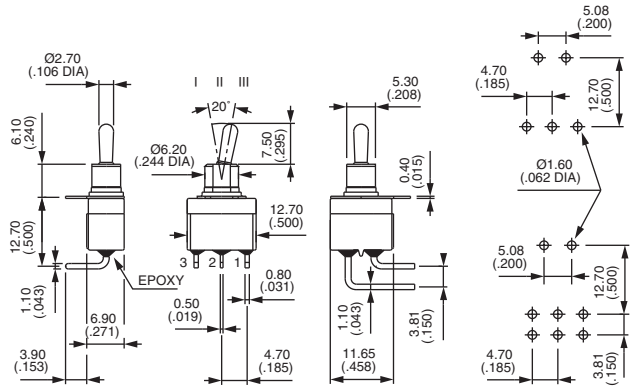

Right angle terminals - vertical



Single pole Double pole

SWW236	SWW246
SWW239	SWW249
SWW237	SWW247
SWW238	SWW248**
SWW232	SWW242**
	SWW244TH*

I	II	III
2-3		2-1
5-6		4-5
ON	-	ON
ON	OFF	ON
MOM	OFF	MOM
ON	OFF	MOM
ON	-	MOM
ON	ON	ON

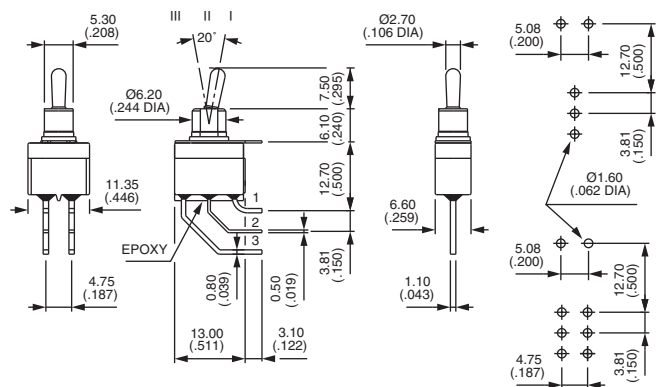

Bracket mounting



Single pole Double pole

SY236	SY246
SY239	SY249
SY237	SY247
SY238	SY248
SY232	SY242
	SY244TH*

III	II	I
2-3		2-1
5-6		4-5
ON	-	ON
ON	OFF	ON
MOM	OFF	MOM
ON	OFF	MOM
ON	-	MOM
ON	ON	ON

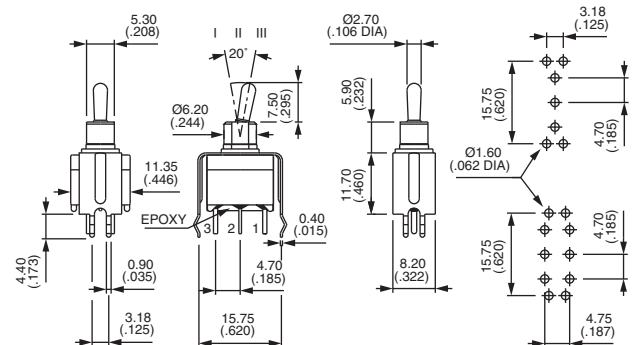

* Function 4 : SP in DP case - TH connection, see end of catalogue.

** Functions 2 and 8 : reversed connection available. Consult factory.

S series

Washable toggle switches - plain bushing

MODEL
STRUCTURE

Right angle terminals - horizontal - spacing 5,08 (.200)

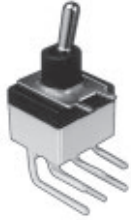

Single pole Double pole

SW036	SW046
SW039	SW049
SW037	SW047
SW038	SW048
SW032	SW042
	SW044TH*

III	II	I
2-3		2-1
5-6		4-5
ON	-	ON
ON	OFF	ON
MOM	OFF	MOM
ON	OFF	MOM
ON	-	MOM
ON	ON	ON

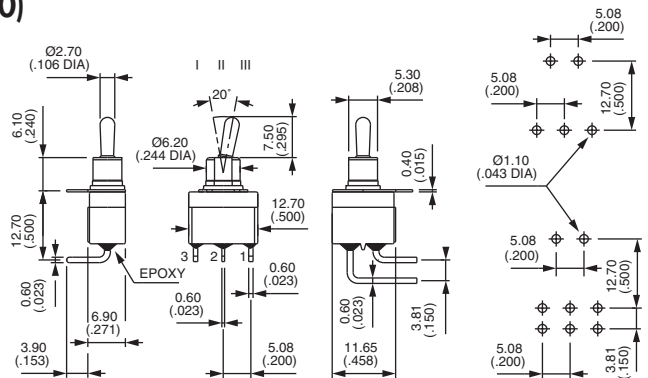

* Function 4 : SP in DP case, see end of catalogue.

PCB MOUNTING

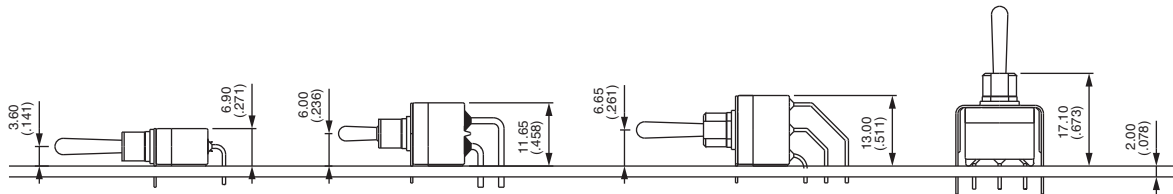

CAP FOR PCB PROCESSING

Provide additional protection during PCB processing.
Supplied mounted on the switch or separately.
Material : vinyl

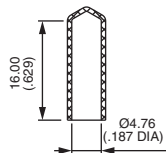

U3012



S series

Washable toggle switches - plain bushing

CONTACT MATERIALS

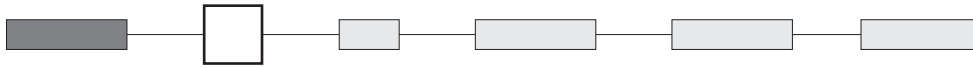

- A Silver
- AD Silver, gold plated
- CD Brass, gold plated

LEVERS

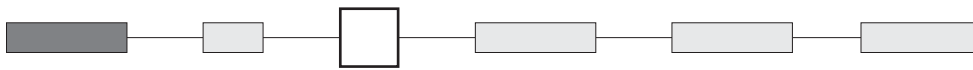

Dash compulsory before lever code.

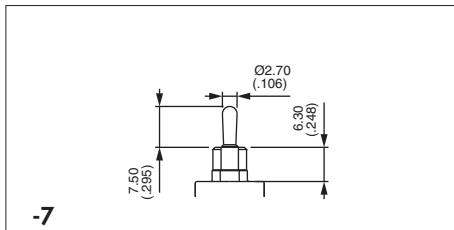

-7
Standard

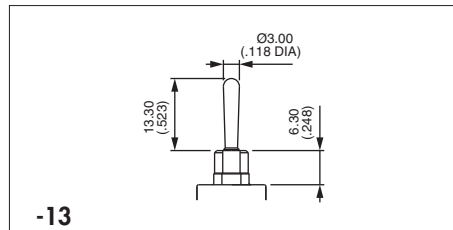

-13
Long



If actuator not specified, we supply former default option -13.

Insulated levers

Protected against electrostatic discharges (ESD) up to 12 KV. Black colour.

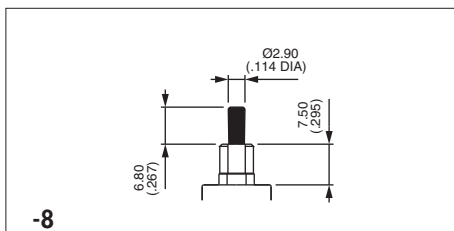

-8
Short

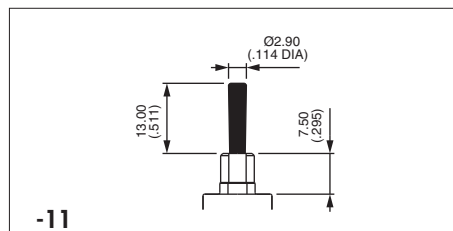

-11
Long



To combine with option X696.

SPECIAL OPTIONS



X601 Silver plated brass contacts
Lower rating - Minimum quantity : 5.000 pieces per model and shipment.

X696 Higher bushing 7,50 (.295). Compulsory for insulated levers 11 and 8.

S series

Washable toggle switches - plain bushing



AGENCY APPROVALS

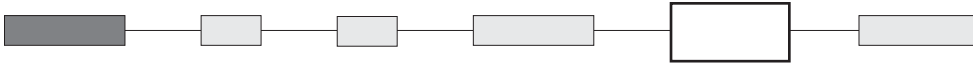

UL
CECC

Availability : consult factory for details of approved models.

Marking : to order switches marked UL or CECC, please complete above box with desired approvals.
Blank : no agency approval required.

INSULATING CAPS

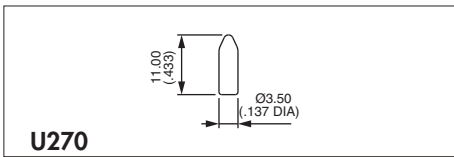
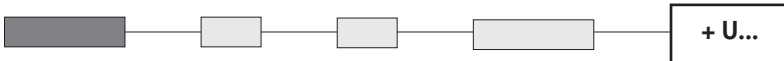

U270

For lever 13

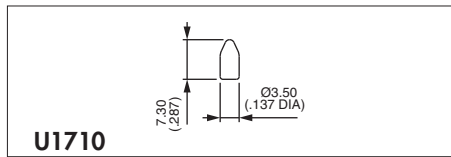

U1710

For lever 7

Cap colours

Replace "0" by number

- | | |
|-----|-----------|
| 1 | blue |
| 1/4 | dark blue |
| 2 | black |
| 3 | green |
| 4 | grey |
| 5 | yellow |
| 6 | red |
| 7/1 | white |
| 9 | orange |

SF series

Washable toggle switches - insulated threaded bushing

Overview

MODEL
STRUCTURE

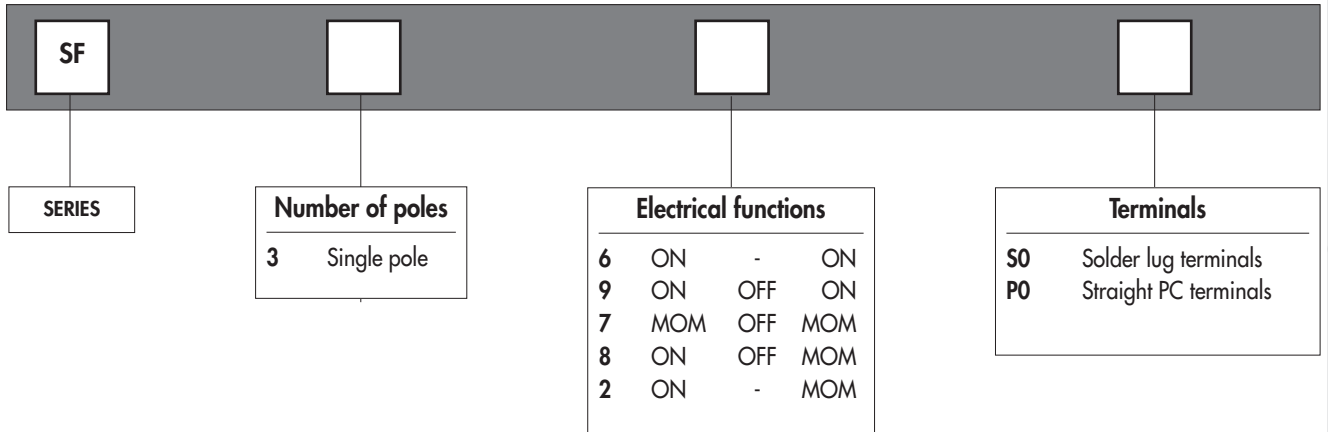

OPTIONS

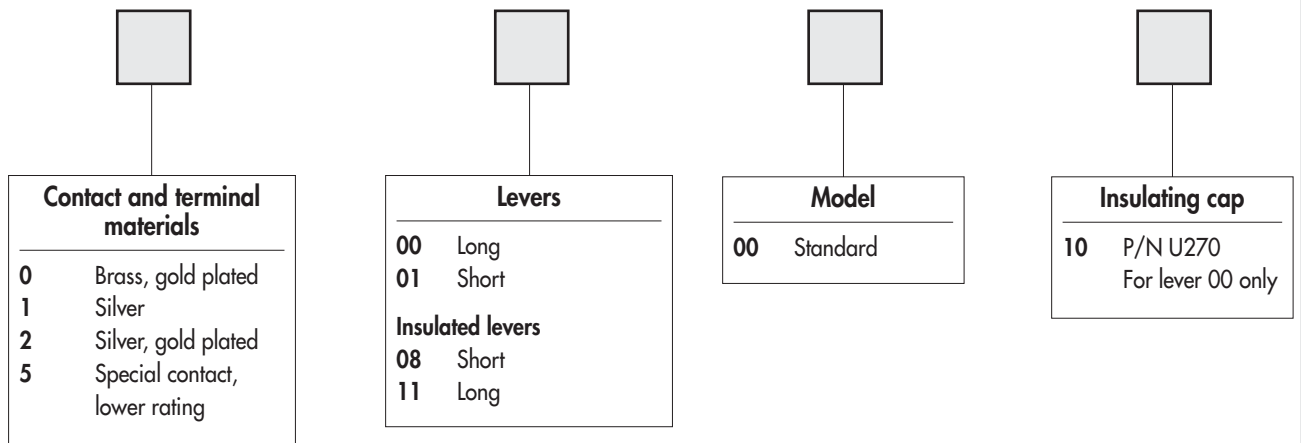

ABOUT THIS SERIES

On the following pages, you will find successively :

- model structure of switches

- options in the same order as above

Specifications are at the beginning of the S series.

Dimensions : first dimensions are in mm while inches are shown as bracketted numbers.



Mounting accessories : 2 hex nuts 8 mm (.314) across flats, 1 locking ring and 1 lockwasher
Standard and special hardware available are presented in section I.



Packaging unit : 50 to 25 pieces depending on model.

SF series

Washable toggle switches - insulated threaded bushing

Solder lug or straight PC terminals

MODEL
STRUCTURE

→ Keyway

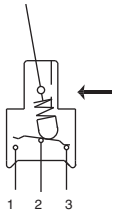

- Single pole configurations
- Max. torque : 0,25 Nm (.184 Ft.lb)
- Iron soldering : 300°C max. 5 sec. max.
- Max. panel thickness :
2,5 mm (.098) with 2 nuts
4 mm (.157) with 1 nut

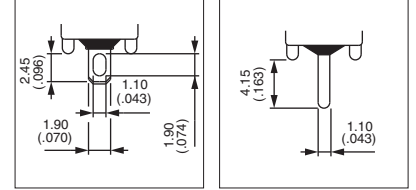

A

MODEL
STRUCTURE

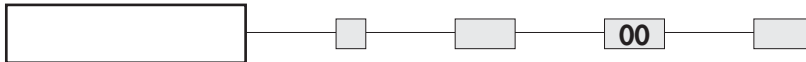

Shown with standard lever 00

Solder lugs : SF..S0

→ Keyway



SF36S0
SF39S0
SF37S0
SF38S0
SF32S0

III	II	I
2-3		1-2
ON	-	ON
ON	OFF	ON
MOM	OFF	MOM
ON	OFF	MOM
ON	-	MOM

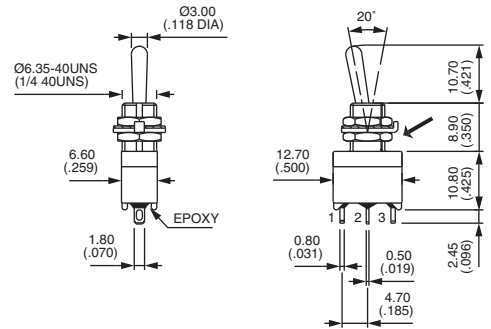

Straight PC terminals : SF..P0

→ Keyway



SF36P0
SF39P0
SF37P0
SF38P0
SF32P0

III	II	I
2-3		1-2
ON	-	ON
ON	OFF	ON
MOM	OFF	MOM
ON	OFF	MOM
ON	-	MOM

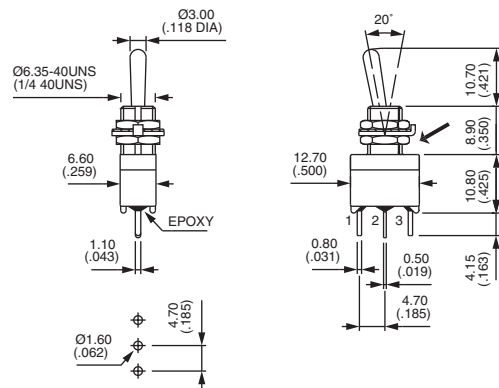

PANEL CUT-OUT

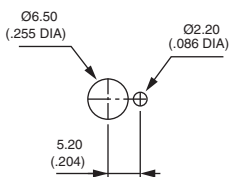



SF series

Washable toggle switches - insulated threaded bushing

CONTACT AND TERMINAL MATERIALS

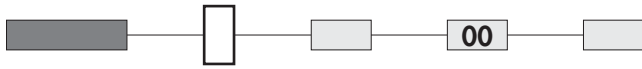

- 0 Brass, gold plated (standard)
- 1 Silver
- 2 Silver, gold plated
- 5 Special contact, lower rating, minimum quantity : consult factory.

LEVERS

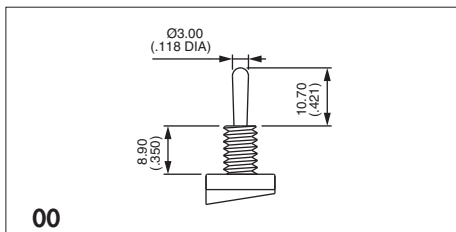
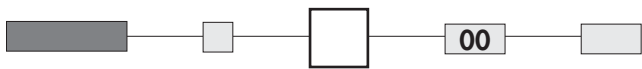

00
Standard

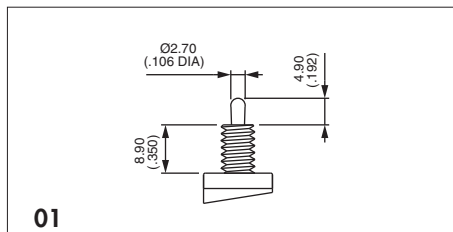

01

Insulated levers

Protected against electrostatic discharges (ESD) up to 12KV. Black colour.

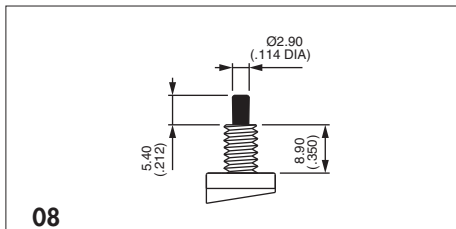

08
Short

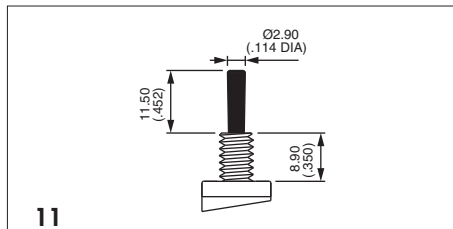

11
Long

INSULATING CAP

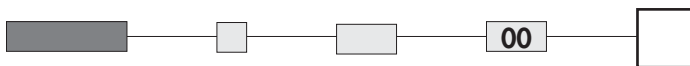

Blank Without cap

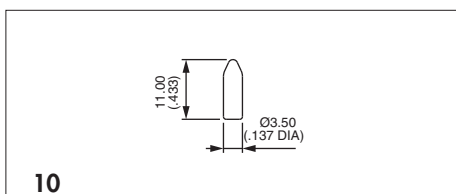

10
P/N U270 - For lever 00

To order cap separately, use its part number (U270).

Cap colours

Replace "0" by number

- 1 blue
- 1/4 dark blue
- 2 black
- 3 green
- 4 grey
- 5 yellow
- 6 red
- 7/1 white
- 9 orange