

RS ITEM NO 7001577

ITEM NO Q6F1CXXB12E

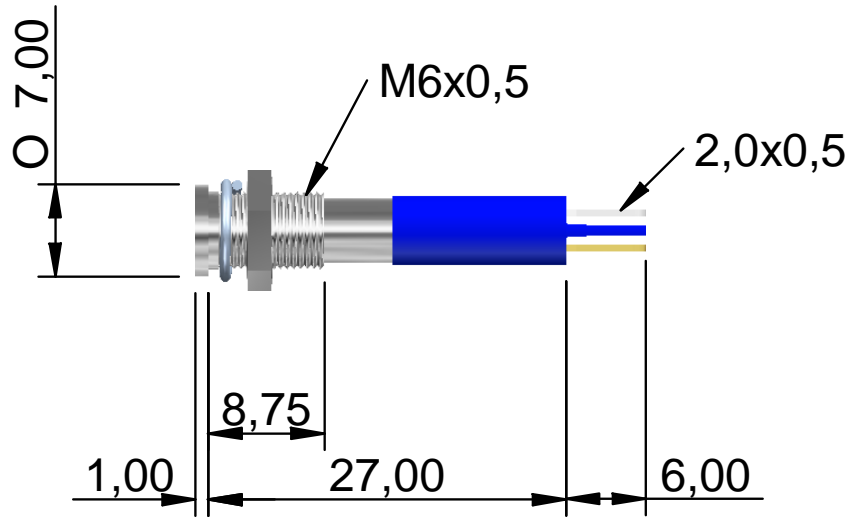

LED/Multiled	<i>LED</i>	Optimum voltage (V)	<i>12Vdc</i>	Intensity	<i>80cmd @20mA typ</i>
Mounting Size	<i>6mm</i>	Rectifier	-	Reverse Voltage	
Mounting Finish	<i>FLUSH</i>	AC current	-		
Protection	<i>IP67</i>	DC current	<i>19mA (max)</i>		
Mount Holder	<i>Satin Bezel</i>	Voltage Tolerance(%)	<i>10%</i>		
Chip Qty	<i>1</i>	Optimum temperature (°C)	<i>-25°C...+60°C</i>		
Indicator colour	<i>BLUE</i>	Storage temperature (°C)	<i>-25°C...+60°C</i>		
Wavelength (nm)	<i>470</i>	Contact Tab x 2	<i>2.0X0.5MM</i>		



*Dimension in mm (typical), not to scale.
We reserve the right to make changes without further notice to this product to improve reliability, function or design.*