

# Reflective Object Sensor

OPB703 through OPB705, OPB703WZ through OPB705WZ,  
OPB70AWZ through OPB70HWZ



## Features:

- Phototransistor output
- High sensitivity
- Low-cost plastic housing
- Available with lenses for dust protection and ambient light filtration
- Focused for maximum sensitivity

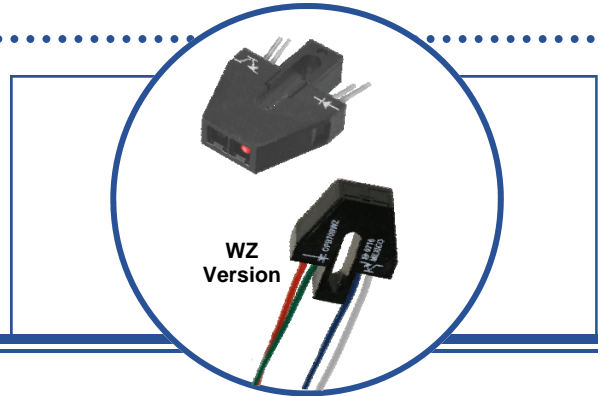

## Description:

The **OPB703**, **OPB704** and **OPB705** consist of an Infrared (890nm) Light Emitting Diode (LED) and a NPN silicon Phototransistor, mounted side-by-side on converging optical axes in a black plastic housing and are designed for PCBoard mounting. The **OPB703WZ**, **OPB704WZ**, **OPB705WZ** and **OPB70BWZ** are designed for remote mounting utilizing interconnect wires of UL approved 26 AWG, 24" (61.0cm) minimum length, stripped and tinned.

The **OPB70AWZ** consists of an Infrared (890nm) Light Emitting Diode (LED) and a NPN silicon Photodarlington, mounted side-by-side on converging optical axes in a black plastic housing and is designed for remote mounting utilizing interconnect wires of UL approved 26 AWG, 24" (61.0cm) minimum length, stripped and tinned.

The **OPB70CWZ through OPB70FWZ** consist of a Visible (Red 640nm) Light Emitting Diode (LED) and a NPN silicon Phototransistor or Rbe Phototransistor, mounted side-by-side on converging optical axes in a black plastic housing and are designed for remote mounting utilizing interconnect wires of UL approved 26 AWG, 24" (61.0cm) minimum length, stripped and tinned.

Various lens options are available: No lens for the (**OPB703**, **OPB703WZ**), blue window for dust protection for the (**OPB704**, **OPB704WZ**, **OPB70BWZ**, **OPB70HWZ**) and aperture lens for improved resolution for the (**OPB705**, **OPB705WZ**, **OPB70AWZ**, **OPB70CWZ**, **OPB70DWZ**). The **OPB704G** and **OPB704GWZ** offers excellent protection for dirty environments.

The phototransistor responds to illumination from the emitter when a reflective object passes within the field of view centered typically at 0.15" (3.8 mm).

Custom electrical, wire, cabling and connectors are available. Contact your local representative or OPTEK for more information.

## Applications:

- Non-contact reflective object sensor
- Assembly line automation
- Machine automation
- Machine safety
- End of travel sensor
- Door sensor
- Mark Detection
- Office Equipment
- Gaming Equipment

Ordering Information					
Part	LED Peak	Detector	Optical Cover	Lead or Wire	
OPB703	890 nm	Transistor	None	0.160" Leads	
OPB703WZ				24" / 26 AWG Wire	
OPB704			Blue Window	0.160" Leads	
OPB704WZ				24" / 26 AWG Wire	
OPB70HWZ				24" / 26 AWG Wire	
OPB704G				0.160" Leads	
OPB704GWZ				24" / 26 AWG Wire	
OPB705				Aperture	0.160" Leads
OPB705WZ			24" / 26 AWG Wire		
OPB70AWZ				Darlington	
OPB70BWZ				Rbe Transistor	Blue Window
OPB70CWZ				Rbe Transistor	Aperture
OPB70DWZ			Transistor		
OPB70EWZ			Rbe Transistor	Clear Window	
OPB70FWZ	Transistor				



RoHS

OPTEK reserves the right to make changes at any time in order to improve design and to supply the best product possible.

# Reflective Object Sensor

OPB703 through OPB705, OPB703WZ through OPB705WZ,  
OPB70AWZ through OPB70HWZ



## OPB703, OPB704, OPB705

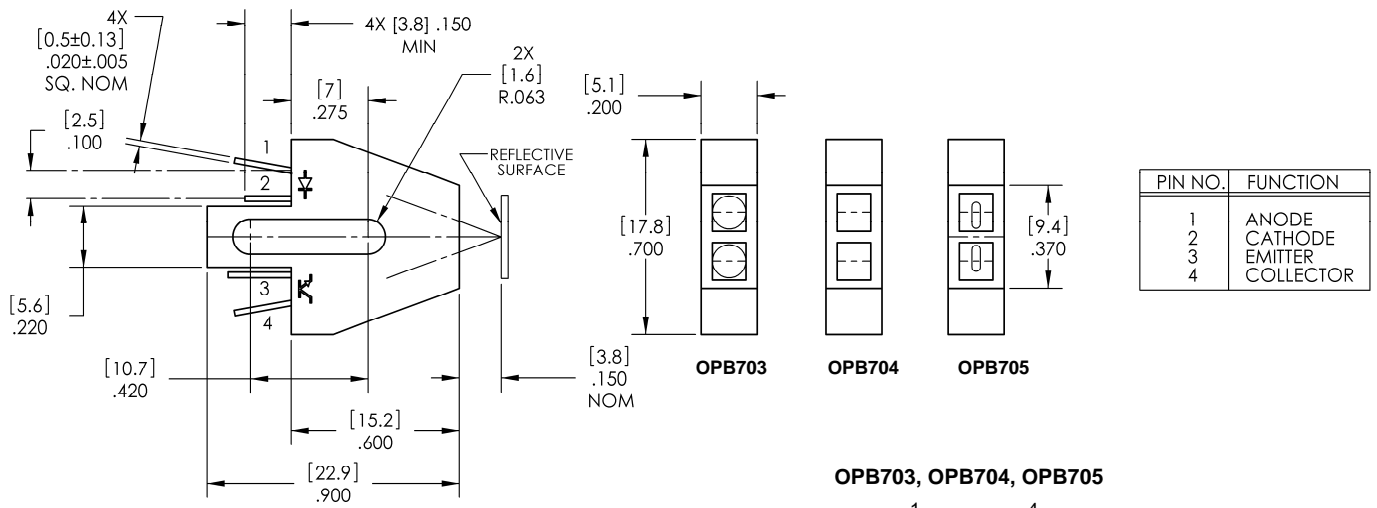

PIN NO.	FUNCTION
1	ANODE
2	CATHODE
3	EMITTER
4	COLLECTOR

DIMENSIONS ARE IN INCHES [MM]  
TOLERANCES ARE ± .010 UNLESS OTHERWISE SPECIFIED.

### OPB703, OPB704, OPB705

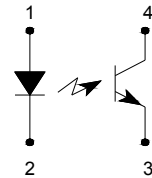

## OPB703WZ, OPB704WZ, OPB705WZ, OPB70AWZ, OPB70BWZ, OPB70CWZ, OPB70DWZ

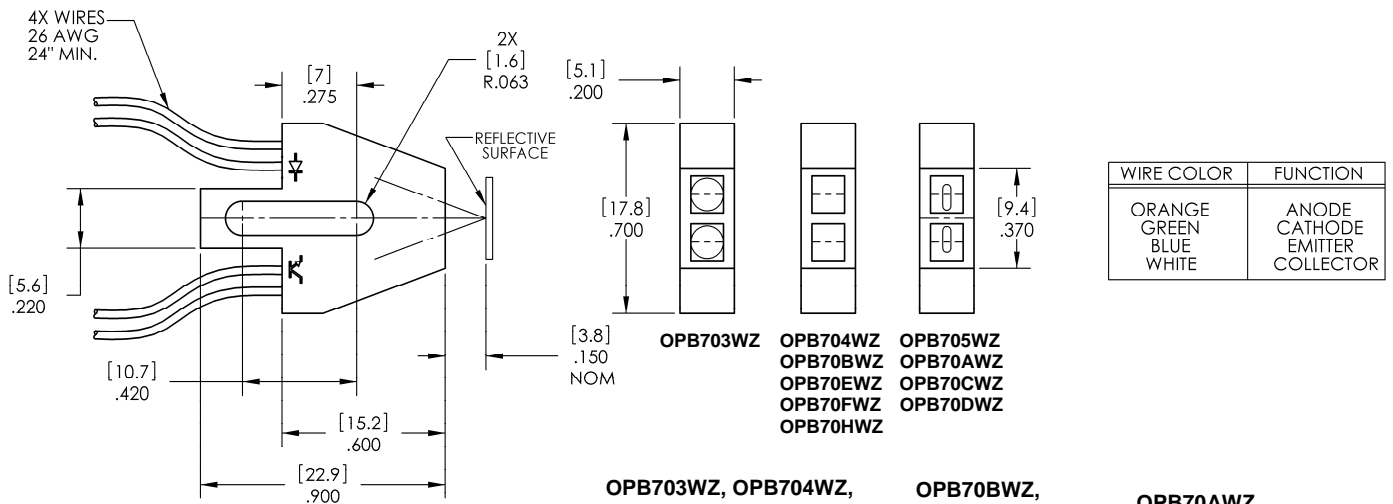

WIRE COLOR	FUNCTION
ORANGE	ANODE
GREEN	CATHODE
BLUE	EMITTER
WHITE	COLLECTOR

DIMENSIONS ARE IN INCHES [MM]  
TOLERANCES ARE ± .010 UNLESS OTHERWISE SPECIFIED.

### OPB703WZ, OPB704WZ, OPB705WZ, OPB70DWZ OPB70HWZ

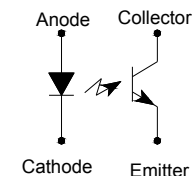

### OPB70BWZ, OPB70CWZ OPB70EWZ

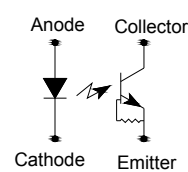

### OPB70AWZ

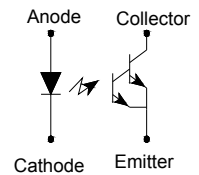

OPTEK reserves the right to make changes at any time in order to improve design and to supply the best product possible.

**Reflective Object Sensor**  
**OPB703 through OPB705, OPB703WZ through OPB705WZ,**  
**OPB70AWZ through OPB70HWZ**



**OPB704G**

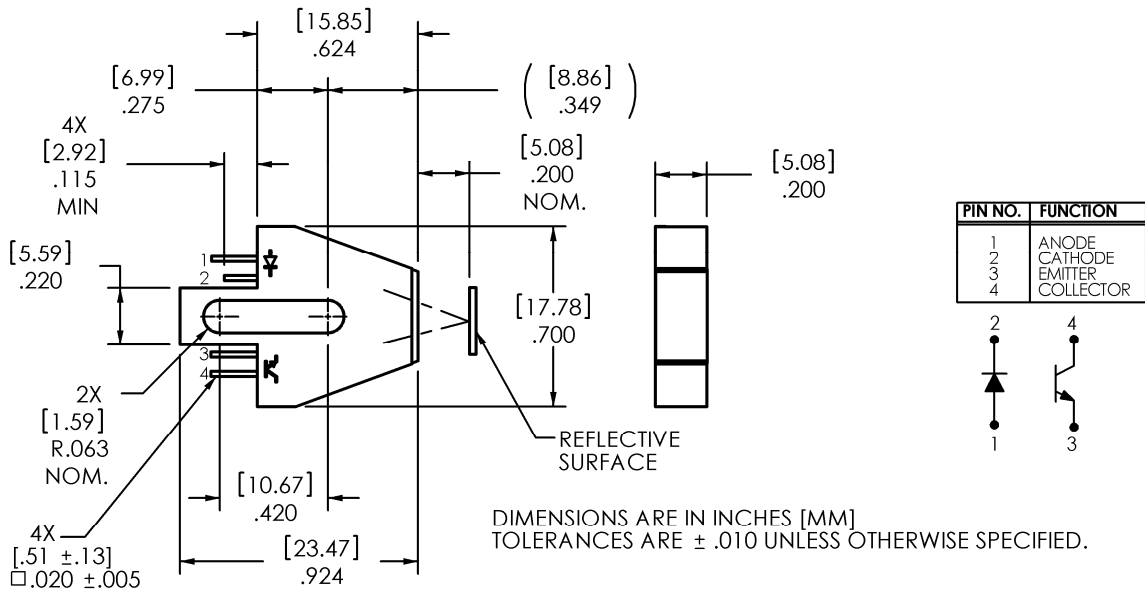

**OPB704GWZ**

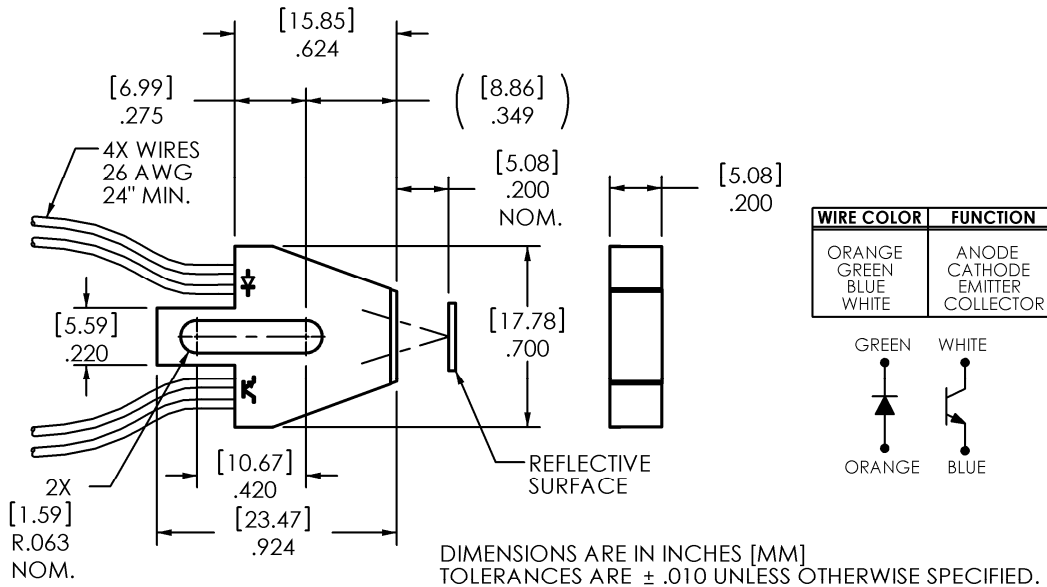

OPTEK reserves the right to make changes at any time in order to improve design and to supply the best product possible.

# Reflective Object Sensor

OPB703 through OPB705, OPB703WZ through OPB705WZ,  
OPB70AWZ through OPB70HWZ



## Absolute Maximum Ratings ( $T_A=25^\circ\text{C}$ unless otherwise noted)

Storage Temperature Range	-40°C to +80°C
Lead Soldering Temperature [1/16 inch (1.6 mm) from the case for 5 sec. with soldering iron]	240°C <sup>(1)</sup>

### Input Diode

Forward DC Current	40 mA
Reverse DC Voltage	2 V
Power Dissipation	100 mW <sup>(2)</sup>

### Output Photodetector

Collector-Emitter Voltage Phototransistor Photodarlington	30 V 15 V
Emitter-Collector Voltage	5 V
Collector DC Current	25 mA
Power Dissipation	100 mW <sup>(2)</sup>

## Electrical Characteristics ( $T_A = 25^\circ\text{C}$ unless otherwise noted)

(OPB703, OPB703WZ, OPB704, OPB704WZ, OPB705, OPB705WZ, OPB704G, OPB704GWZ, OPB70HWZ)

SYMBOL	PARAMETER	MIN	TYP	MAX	UNITS	TEST CONDITIONS
--------	-----------	-----	-----	-----	-------	-----------------

### Input Diode (See OP265 for additional information — for reference only)

$V_F$	Forward Voltage	-	-	1.7	V	$I_F = 40\text{mA}$
$I_R$	Reverse Current	-	-	100	$\mu\text{A}$	$V_R = 2\text{V}$

### Output Phototransistor (See OP505 for additional information — for reference only)

$V_{(BR)CEO}$	Collector-Emitter Breakdown Voltage	30	-	-	V	$I_{CE} = 100\ \mu\text{A}$
$V_{(BR)ECO}$	Emitter-Collector Breakdown Voltage	5	-	-	V	$I_{EC} = 100\ \mu\text{A}$
$I_{CEO}$	Collector Dark Current	-	-	250	nA	$V_{CE} = 10\text{V}, I_F = 0, E_E = 0$

### Coupled

$I_{C(ON)}$	On-State Collector Current OPB70HWZ OPB703, OPB703WZ OPB704, OPB704WZ OPB705, OPB705WZ	0.60 0.30 0.20 0.15	- - - -	3.5 2.5 2.5 1.0	mA	$V_{CE} = 5\text{V}, I_F = 40\text{mA}, d = 0.15''$ <sup>(3)(7)</sup>
	OPB704G, OPB704GWZ	0.50	-	6.0		
$I_{CX}$	Crosstalk	-	-	20	$\mu\text{A}$	$V_{CE} = 5\text{V}, I_F = 40\text{mA}$ <sup>(6)</sup>
	OPB703, OPB703WZ	-	-	20		
	OPB704, OPB704WZ, OPB70HWZ	-	-	20		
	OPB705, OPB705WZ	-	-	10		

#### Notes:

- (1) RMA flux is recommended. Duration can be extended to 10 seconds maximum when flow soldering.
- (2) For OPB703, OPB704 and OPB705, derate linearly 1.67 mW/°C above 25°C.
- (3) For OPB703WZ, OPB704WZ, OPB705WZ, OPB70BWZ, OPB704G, OPB704GWZ and OPB70HWZ derate linearly 1.82 mW/°C above 25°C.
- (4) The distance from the assembly face to the reflective surface is d.
- (5) Crosstalk ( $I_{CX}$ ) is the collector current measured with the indicated current in the input diode and with no reflecting surface.
- (6) Measured using Eastman Kodak neutral white test card with 90% diffuse reflectance as a reflecting surface. Reference: Eastman Kodak, Catalog # E 152 7795.

OPTEK reserves the right to make changes at any time in order to improve design and to supply the best product possible.

**Reflective Object Sensor**  
**OPB703 through OPB705, OPB703WZ through OPB705WZ,**  
**OPB70AWZ through OPB70HWZ**



**Electrical Characteristics** ( $T_A = 25^\circ\text{C}$  unless otherwise noted)  
**(OPB70AWZ)**

SYMBOL	PARAMETER	MIN	TYP	MAX	UNITS	TEST CONDITIONS
--------	-----------	-----	-----	-----	-------	-----------------

**Input Diode** (See OP265 for additional information — for reference only)

$V_F$	Forward Voltage	-	-	1.7	V	$I_F = 40\text{mA}$
$I_R$	Reverse Current	-	-	100	$\mu\text{A}$	$V_R = 2\text{V}$

**Output PhotoDarlington** (See OP535 for additional information — for reference only)

$V_{(BR)CEO}$	Collector-Emitter Breakdown Voltage	15	-	-	V	$I_{CE} = 1.0\text{mA}, E_E = 0$
$V_{(BR)ECO}$	Emitter-Collector Breakdown Voltage	5	-	-	V	$I_{EC} = 100\mu\text{A}, E_E = 0$
$I_{CEO}$	Collector Dark Current	-	-	250	nA	$V_{CE} = 10\text{V}, I_F = 0, E_E = 0$

**Coupled**

$I_{C(ON)}$	On-State Collector Current	5.0	-	26.0	mA	$V_{CE} = 5\text{V}, I_F = 40\text{mA}, d = 0.15''^{(2)(5)}$
$V_{(SAT)}$	Saturation Voltage	-	-	1.15	V	$I_C = 400\mu\text{A}, I_F = 40\text{mA}, d = 0.15''^{(2)(5)}$
$I_{CX}$	Crosstalk	-	-	25	$\mu\text{A}$	$V_{CE} = 5\text{V}, I_F = 40\text{mA}^{(4)}$

Notes:

- (1) RMA flux is recommended. Duration can be extended to 10 seconds maximum when flow soldering.
- (2) Derate linearly  $1.82\text{mW}/^\circ\text{C}$  above  $25^\circ\text{C}$ .
- (3) The distance from the assembly face to the reflective surface is  $d$ .
- (4) Crosstalk ( $I_{CX}$ ) is the collector current measured with the indicated current in the input diode and with no reflecting surface.
- (5) Measured using Eastman Kodak neutral white test card with 90% diffuse reflectance as a reflecting surface. Reference: Eastman Kodak, Catalog # E 152 7795.
- (6) All parameters tested using pulse techniques.

OPTEK reserves the right to make changes at any time in order to improve design and to supply the best product possible.

**Reflective Object Sensor**  
**OPB703 through OPB705, OPB703WZ through OPB705WZ,**  
**OPB70AWZ through OPB70HWZ**



**Electrical Characteristics** ( $T_A = 25^\circ\text{C}$  unless otherwise noted)  
**(OPB70BWZ)**

SYMBOL	PARAMETER	MIN	TYP	MAX	UNITS	TEST CONDITIONS
--------	-----------	-----	-----	-----	-------	-----------------

**Input Diode** (See OP265 for additional information — for reference only)

$V_F$	Forward Voltage	-	-	1.7	V	$I_F = 40\text{mA}$
$I_R$	Reverse Current	-	-	100	$\mu\text{A}$	$V_R = 2\text{V}$

**Output Phototransistor** (See OP705 for additional information — for reference only)

$V_{(BR)CEO}$	Collector-Emitter Breakdown Voltage	30	-	-	V	$I_{CE} = 100\ \mu\text{A}$
$V_{(BR)ECO}$	Emitter-Collector Breakdown Voltage	0.4	-	-	V	$I_{EC} = 100\ \mu\text{A}$
$I_{CEO}$	Collector Dark Current	-	-	100	nA	$V_{CE} = 10\text{V}, I_F = 0, E_E = 0$

**Coupled**

$I_{C(ON)}$	On-State Collector Current OPB70BWZ	0.50	-	3.0	mA	$V_{CE} = 5\text{V}, I_F = 40\text{mA}, d = 0.15''^{(3)(6)}$
$I_{CX}$	Crosstalk OPB70BWZ	-	-	5	$\mu\text{A}$	$V_{CE} = 5\text{V}, I_F = 40\text{mA}^{(5)}$

Notes:

- (1) RMA flux is recommended. Duration can be extended to 10 seconds maximum when flow soldering.
- (2) For OPB703, OPB704 and OPB705, derate linearly  $1.67\text{ mW}/^\circ\text{C}$  above  $25^\circ\text{C}$ .
- (3) For OPB703WZ, OPB704WZ, OPB705WZ and OPB70BWZ, derate linearly  $1.82\text{ mW}/^\circ\text{C}$  above  $25^\circ\text{C}$ .
- (4) The distance from the assembly face to the reflective surface is  $d$ .
- (5) Crosstalk ( $I_{CX}$ ) is the collector current measured with the indicated current in the input diode and with no reflecting surface.
- (6) Measured using Eastman Kodak neutral white test card with 90% diffuse reflectance as a reflecting surface. Reference: Eastman Kodak, Catalog # E 152 7795.
- (7) All parameters tested using pulse techniques.

OPTEK reserves the right to make changes at any time in order to improve design and to supply the best product possible.

**Reflective Object Sensor**  
**OPB703 through OPB705, OPB703WZ through OPB705WZ,**  
**OPB70AWZ through OPB70HWZ**



**Electrical Characteristics** ( $T_A = 25^\circ \text{C}$  unless otherwise noted)  
**(OPB70CWZ and OPB70EWZ)**

SYMBOL	PARAMETER	MIN	TYP	MAX	UNITS	TEST CONDITIONS
--------	-----------	-----	-----	-----	-------	-----------------

**Input Diode** (See OVLAS6CB8 for additional information — for reference only)

$V_F$	Forward Voltage	-	-	2.6	V	$I_F = 40\text{mA}$
$I_R$	Reverse Current	-	-	100	$\mu\text{A}$	$V_R = 2 \text{ V}$

**Output Phototransistor** (See OP505 for additional information — for reference only)

$V_{(BR)CEO}$	Collector-Emitter Breakdown Voltage	30	-	-	V	$I_{CE} = 100\mu\text{A}, I_F = 0, E_E = 0$
$V_{(BR)ECO}$	Emitter-Collector Breakdown Voltage	0.4	-	-	V	$I_{EC} = 100\mu\text{A}, I_F = 0, E_E = 0$
$I_{CEO}$	Collector Dark Current	-	-	100	nA	$V_{CE} = 10 \text{ V}, I_F = 0, E_E = 0$

**Coupled**

$I_{C(ON)}$	On-State Collector Current	OPB70CWZ	.10	-	1.0	mA	$V_{CE} = 5 \text{ V}, I_F = 40\text{mA}, d = 0.15''^{(2)(5)}$
		OPB70EWZ	.25	-	2.5		
$V_{(SAT)}$	Saturation Voltage	-	-	0.4	V	$I_C = 100 \mu\text{A}, I_F = 40\text{mA}, d = 0.15''^{(2)(5)}$	
$I_{CX}$	Crosstalk	-	-	2	$\mu\text{A}$	$V_{CE} = 5 \text{ V}, I_F = 40\text{mA}^{(4)}$	

Notes:

- (1) RMA flux is recommended. Duration can be extended to 10 seconds maximum when flow soldering.
- (2) For OPB703WZ, OPB704WZ, OPB705WZ and OPB70BWZ, derate linearly  $1.82 \text{ mW}/^\circ \text{C}$  above  $25^\circ \text{C}$ .
- (3) The distance from the assembly face to the reflective surface is  $d$ .
- (4) Lower curve is based on a calculated worst-case condition, rather than the conventional  $-2\Omega$  limit.
- (5) Crosstalk ( $I_{CX}$ ) is the collector current measured with the indicated current in the input diode and with no reflecting surface.
- (6) Measured using Eastman Kodak neutral white test card with 90% diffuse reflectance as a reflecting surface. Reference: Eastman Kodak, Catalog # E 152 7795.
- (7) All parameters tested using pulse techniques.

OPTEK reserves the right to make changes at any time in order to improve design and to supply the best product possible.

**Reflective Object Sensor**  
**OPB703 through OPB705, OPB703WZ through OPB705WZ,**  
**OPB70AWZ through OPB70HWZ**



**Electrical Characteristics** ( $T_A = 25^\circ \text{C}$  unless otherwise noted)  
**(OPB70DWZ and OPB70FWZ)**

SYMBOL	PARAMETER	MIN	TYP	MAX	UNITS	TEST CONDITIONS
--------	-----------	-----	-----	-----	-------	-----------------

**Input Diode** (See OVLAS6CB8 for additional information — for reference only)

$V_F$	Forward Voltage	-	-	2.6	V	$I_F = 40\text{mA}$
$I_R$	Reverse Current	-	-	100	$\mu\text{A}$	$V_R = 2 \text{ V}$

**Output Phototransistor** (See OP505 for additional information — for reference only)

$V_{(BR)CEO}$	Collector-Emitter Breakdown Voltage	30	-	-	V	$I_{CE} = 100\mu\text{A}, I_F = 0, E_E = 0$
$V_{(BR)ECO}$	Emitter-Collector Breakdown Voltage	5.0	-	-	V	$I_{EC} = 100\mu\text{A}, I_F = 0, E_E = 0$
$I_{CEO}$	Collector Dark Current	-	-	250	nA	$V_{CE} = 10 \text{ V}, I_F = 0, E_E = 0$

**Coupled**

$I_{C(ON)}$	On-State Collector Current	OPB70DWZ	.10	-	1.5	mA	$V_{CE} = 5 \text{ V}, I_F = 40\text{mA}, d = 0.15''^{(2)(5)}$
		OPB70FWZ	.25	-	3.5		
$V_{(SAT)}$	Saturation Voltage	-	-	0.4	V	$I_{C(ON)} = 100 \mu\text{A}, I_F = 40\text{mA}, d = 0.15''^{(2)(5)}$	
$I_{CX}$	Crosstalk	-	-	5.0	$\mu\text{A}$	$V_{CE} = 5 \text{ V}, I_F = 40\text{mA}^{(4)}$	

Notes:

- (1) RMA flux is recommended. Duration can be extended to 10 seconds maximum when flow soldering.
- (2) For OPB703WZ, OPB704WZ, OPB705WZ and OPB70BWZ, derate linearly 1.82 mW/° C above 25° C.
- (3) The distance from the assembly face to the reflective surface is d.
- (4) Crosstalk ( $I_{CX}$ ) is the collector current measured with the indicated current in the input diode and with no reflecting surface.
- (5) Measured using Eastman Kodak neutral white test card with 90% diffuse reflectance as a reflecting surface. Reference: Eastman Kodak, Catalog # E 152 7795.
- (6) All parameters tested using pulse techniques.

OPTEK reserves the right to make changes at any time in order to improve design and to supply the best product possible.



**OPB703—Output Distance**

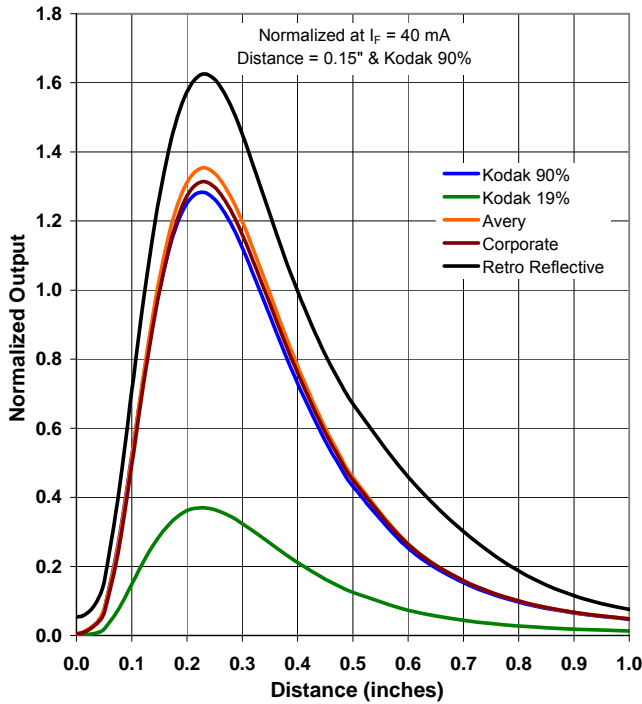

**OPB704, OPB70B, OPB70H—Output Distance**

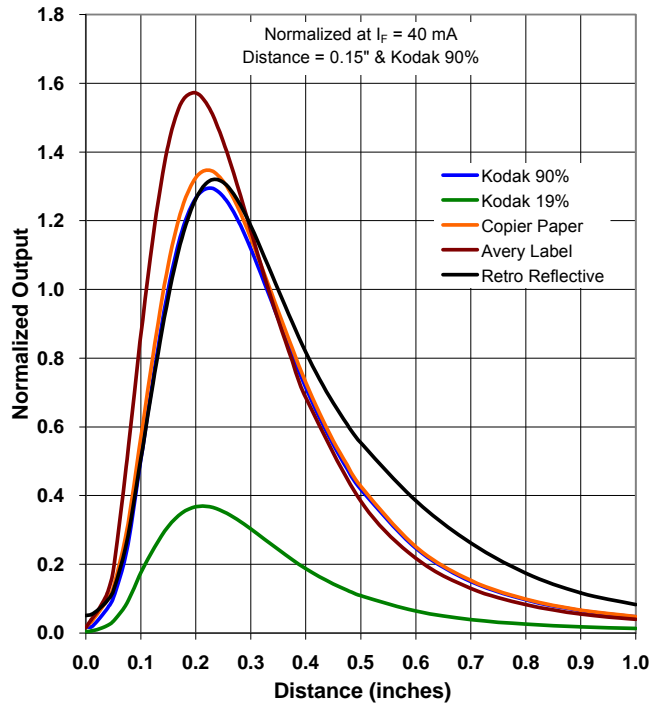

**OPB705, OPB70A, OPB70C, OPB70D—Output Distance**

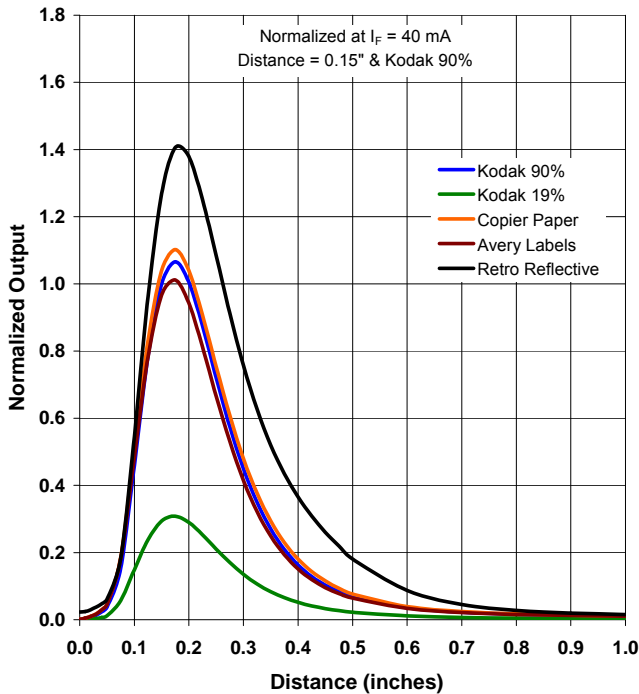

**LED Forward Voltage vs Forward Current vs Temp**

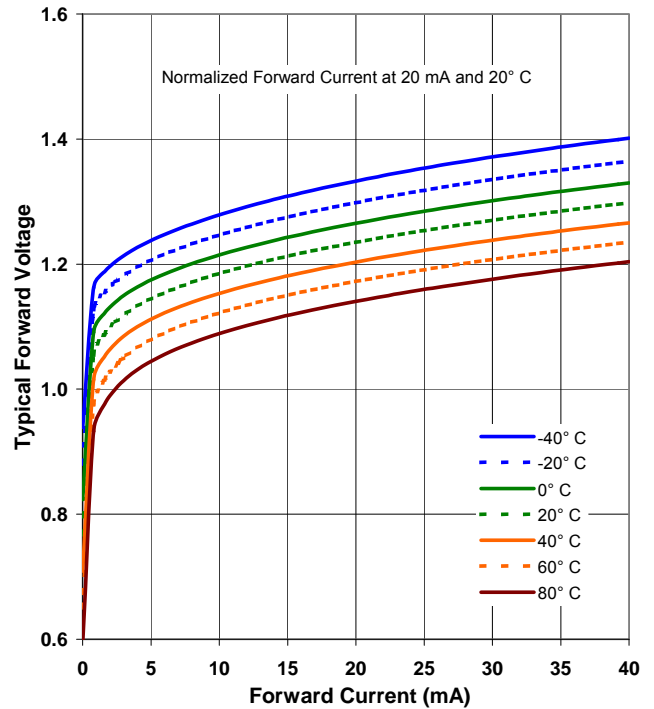

OPTEK reserves the right to make changes at any time in order to improve design and to supply the best product possible.

**Reflective Object Sensor**  
OPB703 through OPB705, OPB703WZ through OPB705WZ,  
OPB70AWZ through OPB70HWZ

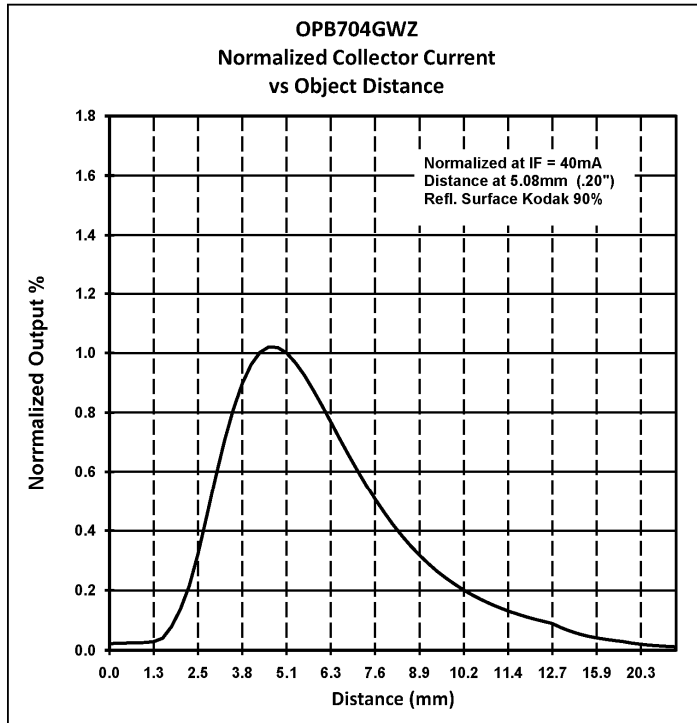

OPTEK reserves the right to make changes at any time in order to improve design and to supply the best product possible.

# Mouser Electronics

Authorized Distributor

Click to View Pricing, Inventory, Delivery & Lifecycle Information:

[TT Electronics:](#)

[OPB704WZ](#) [OPB705](#) [OPB70AWZ](#)