

## Series PVX6012 & PbF

Microelectronic Power IC Relay

IGBT Photovoltaic Relay

Single Pole, Normally Open,

0-280VAC (RMS) or 0-400VDC, 1.0A AC/DC

### General Description

The PVX6012 Photovoltaic Relay is a single-pole, normally open solid-state relay that can replace electromechanical relays in many applications. It utilizes an IGBT output switch, driven by an integrated circuit photovoltaic generator of novel construction. The output switch is controlled by radiation from a GaAlAs light emitting diode (LED) which is optically isolated from the photovoltaic generator.

The PVX6012 is ideally suited for switching medium power loads. It offers high operating speed, low and stable on-state voltage drop as well as low off-state leakage current.

PVX6012 relays are packaged in a 14-pin, molded DIP package in thru-hole. It is available in standard plastic shipping tubes.

### Applications

- Test Equipment
- Industrial Controls and Automation
- Electromechanical Relay Replacement
- Mercury-wetted Relay Replacement

### Features

- IGBT and HEXFRED™ output
- Bounce-free operation
- 3,750 V<sub>RMS</sub> I/O isolation
- High load current capacity
- Low off-state leakage current
- Solid-State reliability
- UL recognized

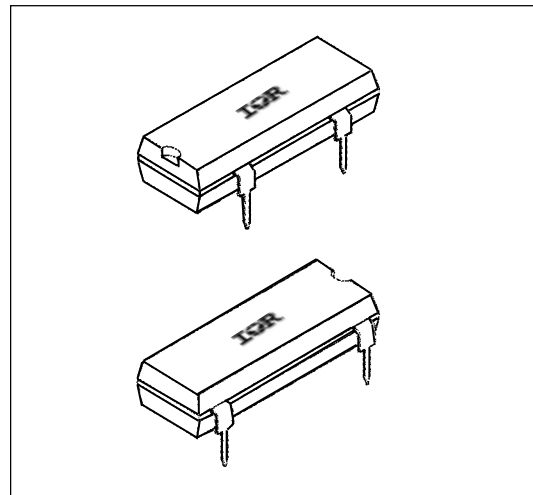

### Part Identification

PVX6012 & PbF thru-hole

**Electrical Specifications** (-40°C ≤ T<sub>A</sub> ≤ +85°C unless otherwise specified)

<b>INPUT CHARACTERISTICS</b>	<b>Limits</b>	<b>Units</b>
Minimum Control Current (see figure 1)	5.0	mA
Maximum Control Current for Off-State Leakage @T <sub>A</sub> =+25°C	0.4	mA
Control Current Range (Caution: current limit input LED, see figure 6)	5.0 to 25	mA
Maximum Reverse Voltage	6.0	V

<b>OUTPUT CHARACTERISTICS</b>	<b>Limits</b>	<b>Units</b>
Transient Overvoltage Protection	600	V(DC or AC peak)
Operating Voltage	0-280 0-400	V(AC) RMS V(DC)
Maximum Load Current @ T <sub>A</sub> = +40°C	1.0	A(DC)
5mA Control (see figure 1 and Note 1)	1.0	A (AC) RMS
Maximum Surge Current		
non-repetitive, 1 sec.	5	A(DC)
non-repetitive 20 msec. (see figure 2)	20	A(DC)
Maximum On-State Voltage Drop @T <sub>A</sub> =+25°C For 1A pulsed load, 5mA Control (see figures 3 and 4)	2.5	V
Maximum Off-State Leakage @T <sub>A</sub> =+25°C, ±400V (see figure 5)	10	µA
Maximum Turn-On Time @T <sub>A</sub> =+25°C (see figure 8) For 1A, 400 V <sub>DC</sub> load, 5mA Control	7	ms
Maximum Turn-Off Time @T <sub>A</sub> =+25°C (see figure 8) For 1A, 400 V <sub>DC</sub> load, 5mA Control	1	ms
Maximum Output Capacitance @ 100V <sub>DC</sub> (see figure 7)	50	pF

**Notes:**

† Load handling capability to 0.2 power factor requires overvoltage protection.

<b>GENERAL CHARACTERISTICS</b>	<b>Limits</b>	<b>Units</b>
Minimum Dielectric Strength, Input-Output	3750	V <sub>RMS</sub>
Minimum Insulation Resistance, Input-Output @T <sub>A</sub> =+25°C, 50%RH, 100V <sub>DC</sub>	10 <sup>12</sup>	Ω
Maximum Capacitance, Input-Output	1.0	pF
Maximum Pin Soldering Temperature (10 seconds maximum)	+260	
Ambient Temperature Range:		°C
Operating	-40 to +85	
Storage	-40 to +100	

International Rectifier does not recommend the use of this product in aerospace, avionics, military or life support applications. Users of this International Rectifier product in such applications assume all risks of such use and indemnify International Rectifier against all damages resulting from such use.

**Connection Diagram**

Output AC or DC Load

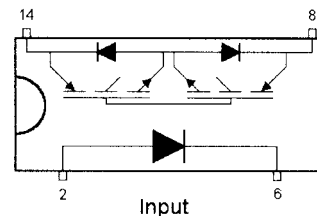

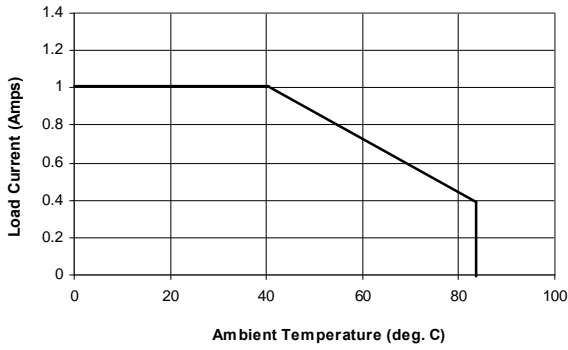

Figure 1. Current Derating Curve

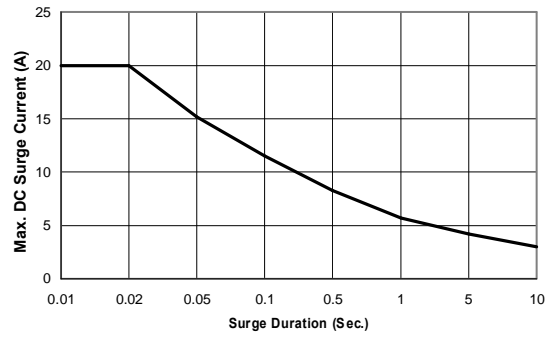

Figure 2. Surge Current Capability

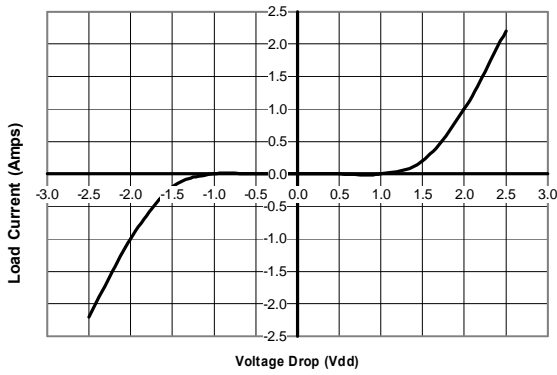

Figure 3. Output Characteristics

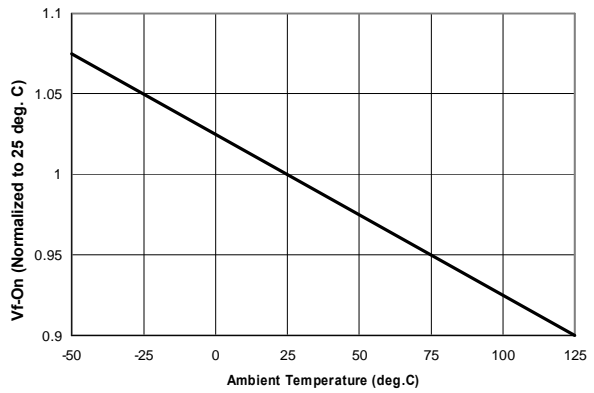

Figure 4. Typical Normalized VCEON

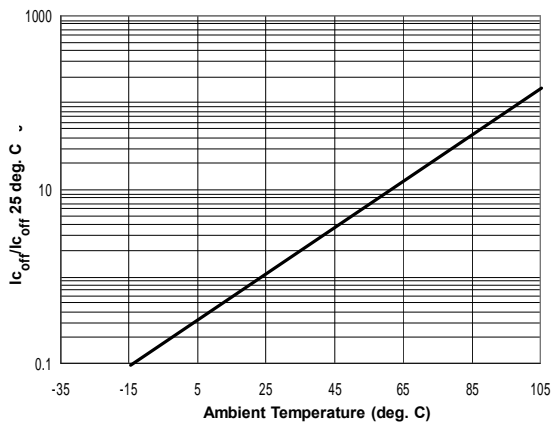

Figure 5. Typical Normalized Off-State Leakage

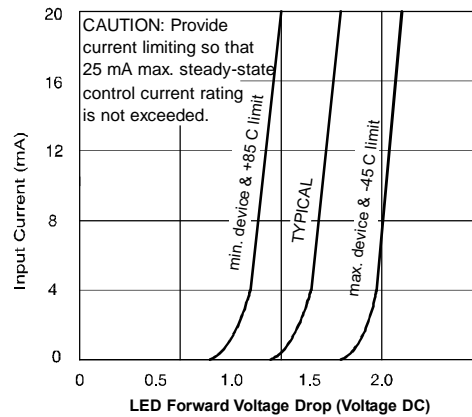
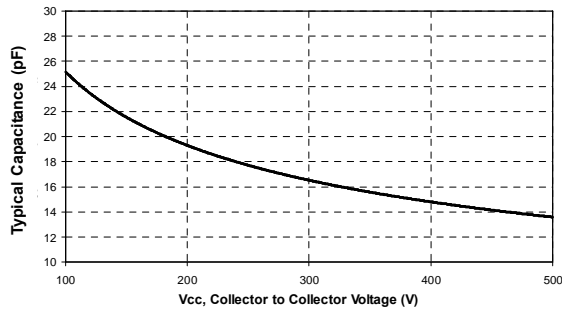
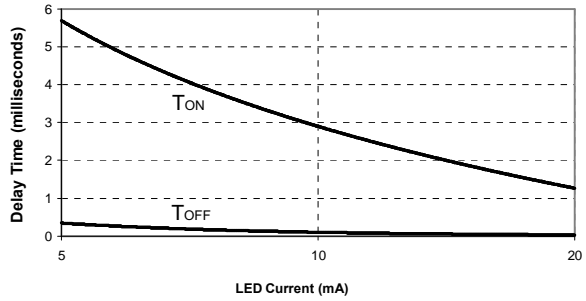

Figure 6. Input Characteristics (Current Controlled)



**Figure 7. Typical Output Capacitance**



**Figure 8. Typical Delay Times**

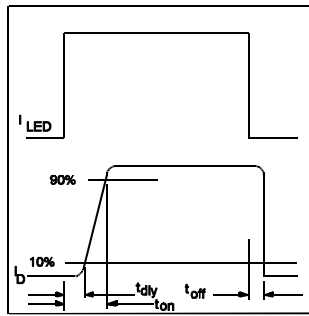

**Figure 9. Delay Time Definitions**

**Case Outline**

**NOTES:**

1. DIMENSIONING & TOLERANCING PER ANSI Y14.5M-1982.
2. CONTROLLING DIMENSION: INCH.
3. DIMENSIONS ARE SHOWN IN MILLIMETERS (INCHES).
4. OUTLINE CONFORMS TO JEDEC OUTLINE MS-001AA.
- 5 MEASURED WITH THE LEADS CONSTRAINED TO BE PERPENDICULAR TO DATUM PLANE C.
- 6 DIMENSION DOES NOT INCLUDE MOLD PROTRUSIONS. MOLD PROTRUSIONS SHALL NOT EXCEED 0.25 (0.010).

01-3062 00

2/2008