



Amphenol

C 16-1 / C 16-3







Circular
Circular Connectors



Overview			
No. of contacts	3 + PE	6 + PE	
Termination	screw	solder	crimp
Wire gauge	max. 2,5 mm ² ; AWG 14	max. 0,75 mm ² ; AWG 18	max. 1,5 mm ² ; AWG 16
Rated insulation voltage	400 V	250 V	200 V
Current carrying capacity	16 A	10 A	13 A
Pollution degree	3	3	
Installation category	III	III	
Protection class	IP 67	IP 67	

C 16-1

Product description
Order information
Approvals

Product description		Order information	
<p>The circular connectors of the C 16-1 series are designed to meet the high requirements of industrial applications under harsh environmental conditions. The range includes versions with screw, solder and crimp terminations. A selection of crimp contacts for hand crimp tools and crimp machines ensure a reliable termination resulting in qualitative, technical and economical advantages. A large selection of housing styles offers the user an optimal solution.</p> <p>Main features and advantages:</p> <ul style="list-style-type: none"> • Circular connectors with contact arrangements 3 + PE and 6 + PE for power and signal applications • For applications in machine tools, measurement and control, process technology and medical equipment • Housing are made from high grade plastic material • Protected against unlocking by threaded coupling • Cable housing straight with PG 9, 11 and 13,5 cable outlet, Cable housing 90° with PG 9 and 11 cable outlet • Protection degree IP 67 per IEC 60529 in mated condition • Internal strain relief with screw clamp or clamping ring provides a safe cable restraint 		<p>Contact plating The standard plating is silver. Gold plated contacts are available upon request. Min order quantity = 100 contacts per type.</p> <p>Color coding Upon request the coupling ring of the plugs and the housings of the receptacles can be delivered in the colors red, green, blue, yellow and grey. Min order quantity = 250 pcs. per type.</p> <p>Mechanical coding Achieved with special coding pins which are inserted into contact cavities. Min. order quantity = 250 pcs. per type.</p> <p>Crimp version Order numbers do not include crimp contacts. Please order separately (see page 30/31). Crimp contact for higher currents (up to 16A) are available upon request.</p> <p>Crimp tooling Ask for our catalog "Tools"</p>	
Testhouse		Characteristics	Approval No.
VDE		3+PE, 400 V, 16 A 6+PE, 250 V, 10 A	1781 1780
SEV		3+PE, 400 V, 16 A 6+PE, 250 V, 6 A	94.1 01173.02
UL		3+PE, 250 V, 12 A 6+PE, 250 V, 8 A	E 63093
CSA		3+PE, 250 V, 12 A 6+PE, 250 V, 8 A 6+PE, 250 V, 15 A	48932
German Llyod		3+PE, 250 V, 16 A 6+PE, 50 V, 8 A	14108 / 84

C 16-1

Characteristics

General Characteristics	Standard	Characteristics		
Number of contacts		3 + PE	6 + PE	
Electrical Characteristics		screw type	solder type	crimp type
Rated insulation voltage	IEC 60664-1	400 V	250 V	200 V
Rated impulse withstand voltage	IEC 60664-1	6000 V	4000 V	
Pollution degree	IEC 60664-1	3	3	
Installation (overvoltage) category	IEC 60664-1	III	III	
Material group	IEC 60664-1	II	II	
Test voltage	IEC 60664-1	2450 V	1680 V	1950 V
Current carrying capacity	IEC 60512-3, Test 5b	16 A / + 55 °C	10 A / + 55 °C	13 A / + 55 °C
Insulation resistance	IEC 60512-2, Test 3a	≥ 10 ⁸ Ω	≥ 10 ⁸ Ω	
Contact resistance	IEC 60512-2, Test 2a	≤ 5 m Ω	≤ 5 m Ω	
Climatical Characteristics				
Climatic category	IEC 6068-1	40 / 100 / 56	40 / 125 / 56	
Operating temperature		-40°C ... +100°C / -40°F ... +212°F		
Mechanical Characteristics				
IP-degree of protection	IEC 60529	IP 67		
Insertion and withdrawal force	IEC 60512-7, Test 13b	≤ 15 N	≤ 30 N	
Mechanical operation	IEC 60512-5, Test 9a	≥ 500 mating cycles		
Materials				
Housing material		Polyamid 6.6		
Dielectric material		Polyamid 6.6		
Gasket material		Neoprene		
Contact plating		silver plated (gold plated upon request)		
Other Characteristics				
Termination technique		screw type	solder	crimp
Wire gauge mm ² / AWG		max. 2,5 / 14	0,75 / 18	0,14 - 1,5 / 26 - 16
Flammability		UL 94 V0		
Locking system		round thread DIN 405		



The stated technical values refer to the use as connector.

If these components are used as plug and socket device a reduced current carrying capacity has to be considered.

C 16-1

Derating curves

No of contacts 3 + PE

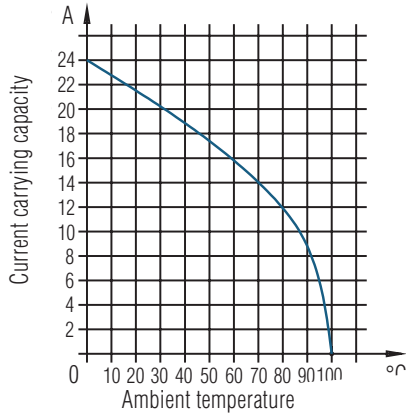

all contacts
wire gauge 2,5 mm², 14 AWG

No of contacts 6 + PE

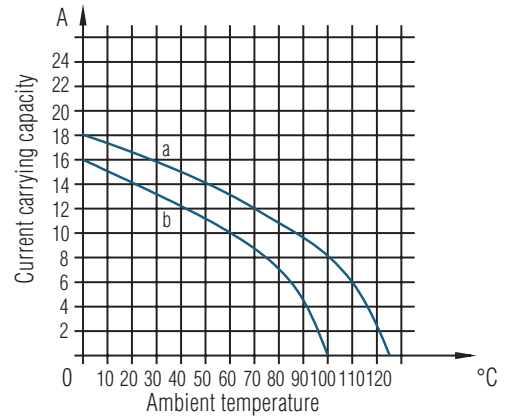

all contacts

- a) wire gauge 1,5 mm², 16 AWG
- b) wire gauge 0,75 mm², 20 AWG

C 16-1

Mounting instructions



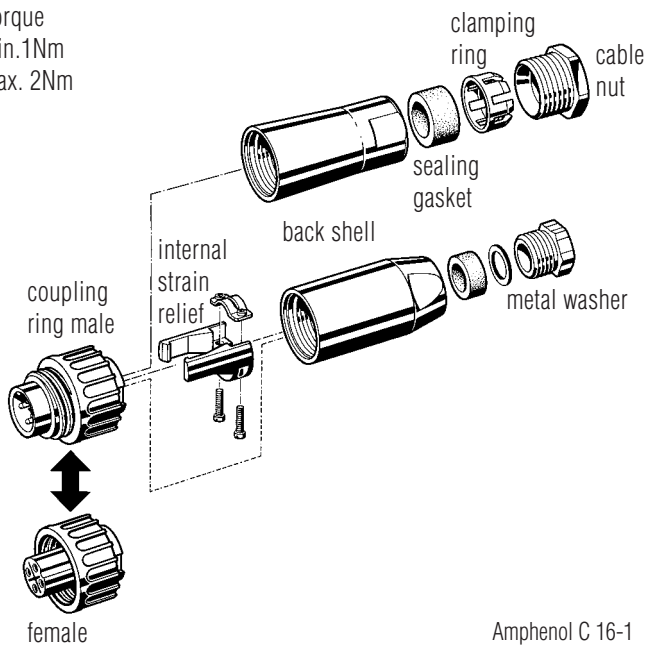

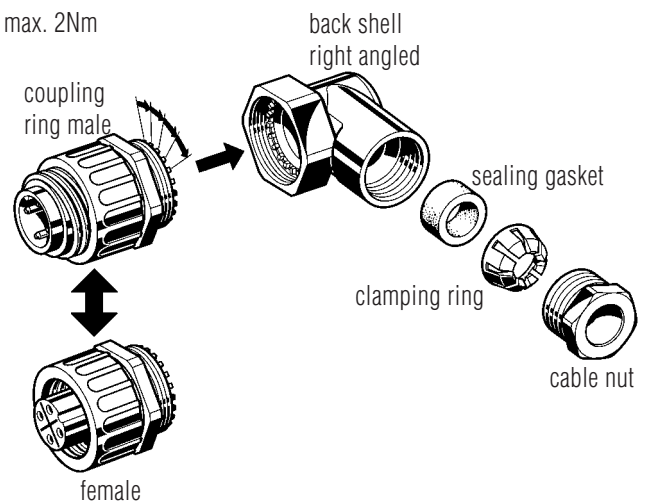

Torque
min. 1Nm
max. 2Nm



Torque
min. 1Nm
max. 2Nm







Shell size 1				
No. of contacts	8 + PE	14 + PE	17 + PE	
Termination	crimp	crimp	crimp	
Wire gauge mm ² / AWG	0,14 - 2,5 / 26 - 14	0,14 - 2,5 / 26 - 14	0,14 - 1,0 / 26 - 18	
Rated insulation voltage	400 V	100 V	100 V	
Current carrying cap.	12 A	11 x 6 A; 4 x 18 A	6 A	
Pollution degree	3	3	3	
Installation category	III	III	III	
Protection class	IP 65	IP 65	IP 65	
Shell size 2				
No. of contacts	5 + PE	12 + PE	14 + PE	19 + PE
Termination	screw	crimp	crimp	crimp
Wire gauge mm ² / AWG	4 / 10	0,14 - 2,5 / 26 - 14	0,14 - 2,5 / 26 - 14	0,14 - 1,0 / 26 - 18
Rated insulation voltage	400 V	3 x 500 V; 9 x 300 V	400 V	250 V
Current carrying cap.	21 A	3 x 21 A; 9 x 11 A	4 x 6 A; 11 x 12 A	6 A
Pollution degree	3	3	3	3
Installation category	III	III	III	III
Protection class	IP 65	IP 65	IP 65	IP 65

C 16-3

Product description
Order information
Approvals

Product description	Order information	
<p>The circular connector series C 16-3 has two housing sizes. The connectors are designed to meet the high requirements of industrial applications under harsh environmental conditions. The range includes versions with screw and crimp terminations. A selection of crimp contacts for hand crimp tools and crimp machines enables a reliable termination resulting in qualitative, technical and economical advantages. A broad selection of housing styles are available.</p> <p>Main features and advantages:</p> <ul style="list-style-type: none"> • Circular connectors for power and signal applications with following contact arrangements: Shell size 1: 8 + PE, 14 + PE, 17 + PE Shell size 2: 5 + PE, 12 + PE, 14 + PE, 19 + PE • For applications in machine tools, measurement and control, process technology and medical equipment • Housing are made from high grade plastic material. • Vibration safe connection by solid bayonet coupling with lock in position. • Cable housing straight and right-angled with various cable outlets • Protection degree IP 65 per IEC 60529 in mated condition. • Internal strain relief with screw clamp or concentric strain relief provides a safe cable restrain. 	<p>Color coding Upon request the coupling ring of the plugs and the housings of the receptacles can be delivered in the color red, green, blue, yellow and grey.</p> <p>Polarization Depending on the contact arrangements the polarization of this connector series can be varied. The contact inserts can be mounted in alternate positions. The order number in the catalog refers always to position 1. The position of the contact inserts can also be changed by the customer using a disassembly tool (see page 26 and 29) to remove the insert and remount it in the required position (see page 19).</p> <p>Crimp version Order numbers do not include crimp contacts. Please order separately (page 30/31). Crimp contacts for higher currents (up to 16A) are available upon request.</p> <p>Crimp tooling Ask for our crimp tooling catalogs.</p>	
Testhouse	Approvals	Approval No.
VDE		3964
UL		E 63093
CSA		49932-9

C 16-3

Coding system

Polarization

Depending on the contact arrangements the polarization of this connector series can be varied. Please take care of the housing and contact insert characteristics.

Shell size 1			Shell size 2		
No of contacts	No of coding possibil.	Position	No of contacts	No of coding possibil.	Position
8 + PE	4	1, 3, 5, 7	5 + PE	6	1, 2, 3, 4, 6, 7
14 + PE	7	1, 2, 3, 4, 5, 6, 7	14 + PE	7	1, 2, 3, 4, 5, 6, 7
17 + PE	6	1, 2, 3, 4, 5, 7	12 + PE	7	1, 2, 3, 4, 5, 6, 7
			19 + PE	6	1, 3, 4, 5, 6, 7

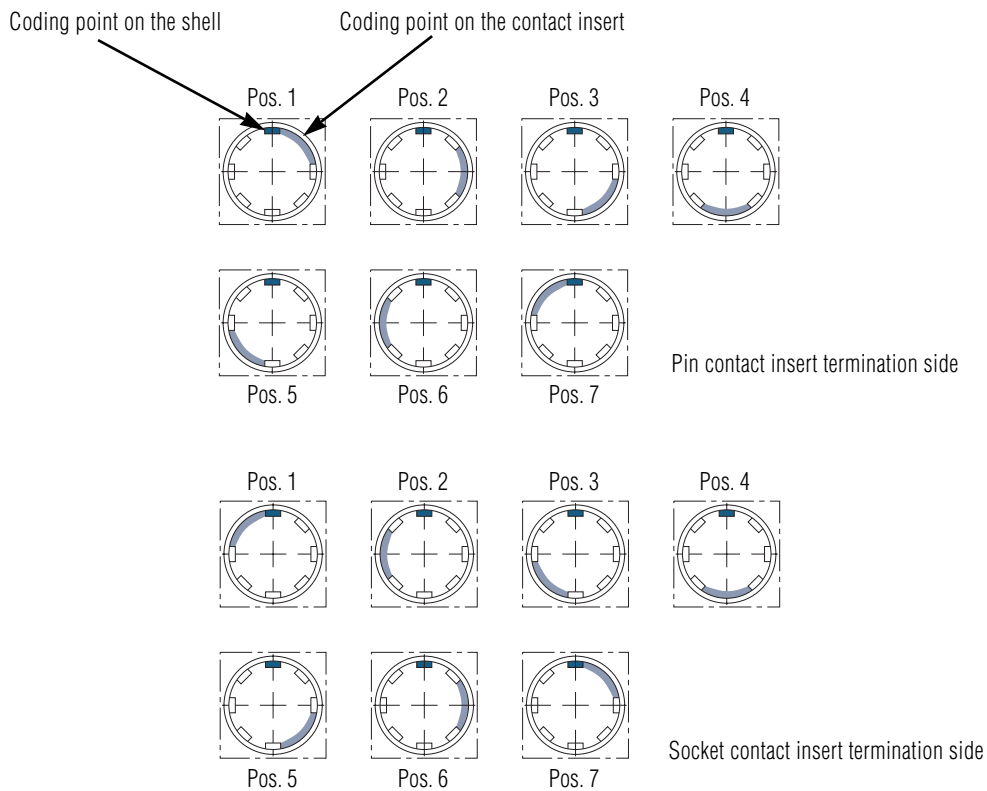

Disassembly of contact inserts with disassembly tool (see page 26 und 29)

