

**50 Volt, 0.1 Ohm HEXFET**

**TO-220AB Plastic Package**

The HEXFET technology has expanded its product base to serve the low voltage, very low R<sub>DS(on)</sub> MOSFET transistor requirements, International Rectifier's highly efficient geometry and unique processing of the HEXFET have been combined to create the lowest on resistance per device performance, in addition to this feature all HEXFETs have documented reliability and parts per million quality !

The HEXFET transistors also offer all of the well established advantages of MOSFETs such as voltage control, very fast switching, ease of paralleling, and temperature stability of the electrical parameters.

They are well suited for applications such as switching power supplies, motor controls, inverters, choppers, audio are operated from low voltage batteries, such as automotive, portable equipment, etc.

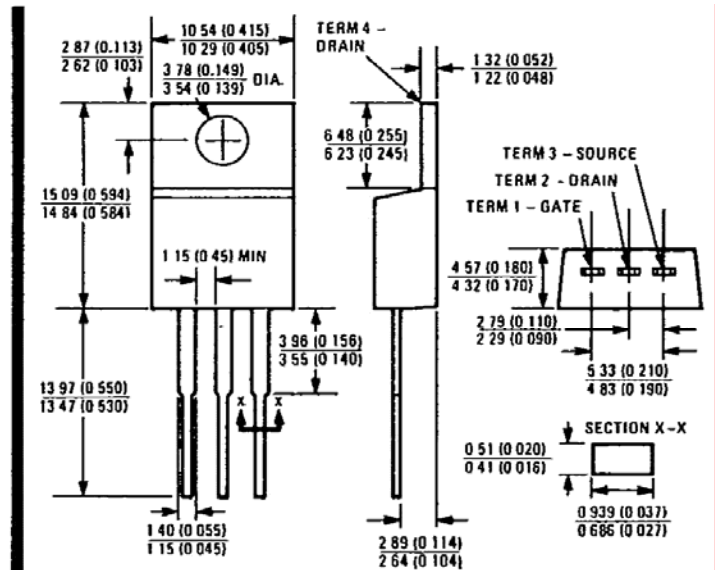
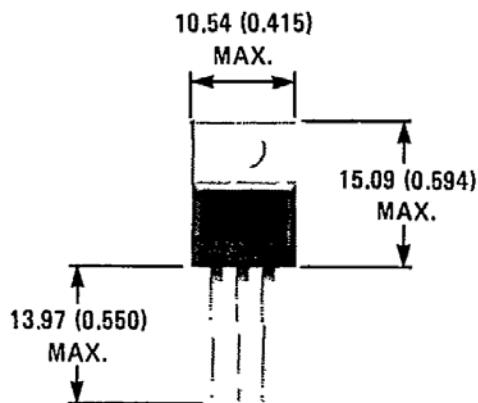
**Product Summary**

Part Number	V <sub>DS</sub>	R <sub>DS(on)</sub>	I <sub>D</sub>
IRFZ20	50V	0.10Ω	15A
IRFZ22	50V	0.12Ω	14A

**Features:**

- Extremely Low R<sub>DS(on)</sub>
- Compact Plastic Package
- Fast Switching
- Low Drive Current
- Ease of Paralleling
- Excellent Temperature Stability
- Parts Per Million Quality

**CASE STYLE AND DIMENSIONS**



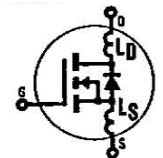
**Case Style TO-220AB**  
 Dimensions in Millimeters and (Inches)

**Absolute Maximum Ratings**

Parameter	IRFZ20	IRFZ22	Units
$V_{DS}$ Drain-Source Voltage	50	50	V
$V_{DGR}$ Drain-Gate Voltage ( $R_{GS} = 20K\Omega$ )	50	50	V
$I_D@T_C=25$ Continuous Drain Current	15	14	A
$I_D@T_C=100$ Continuous Drain Current	10	9.0	A
$I_{DM}$ Pulsed Drain Current	60	56	A
$V_{GS}$ Gate –Source Voltage	$\pm 20$		V
$P_D@T_C=25$ Max. Power Dissipation	40 (See Fig. 14)		W
Linear Derating Factor	0.32 (See Fig. 14)		W/K
$I_{LM}$ Inductive Current, Clamped	(See Fig. 15 and 16) $L=100\mu H$		A
	60	56	
$T_J$ Operating Junction and $T_{stg}$ Storage Temperature Range	-56 to 150		
Lead Temperature	300 (0.063 in. (1.6mm) from case for 10s)		

**Electrical Characteristics @  $T_C=25$  (Unless Otherwise Specified)**


Parameter	Type	Min.	Typ.	Max.	Units	Test Conditions
$BV_{DSS}$ Drain-Source Breakdown Voltage	IRFZ20	50	-	-	V	$V_{GS}=0V$
	IRFZ22	50	-	-	V	$I_D=250\mu A$
$V_{GS(th)}$ Gate Threshold Voltage	ALL	2.0	-	4.0	V	$V_{DS}=V_{GS}$ , $I_D=250\mu A$
$I_{GSS}$ Gate-Source Leakage Forward	ALL	-	-	500	nA	$V_{GS}=20V$
$I_{GSS}$ Gate-Source Leakage Reverse	ALL	-	-	-500	nA	$V_{GS}=-20V$
$I_{DSS}$ Zero Gate Voltage Drain Current	IRFZ20	-	-	250	$\mu A$	$V_{DS}=\text{Max. Rating}$ , $V_{GS}=0V$
	IRFZ22	-	-	1000	$\mu A$	$V_{DS}=\text{Max. Rating} \times 0.8$ , $V_{GS}=0V$ , $T_C=125$
$R_{DS(on)}$ Static Drain-Source On-State Resistance	IRFZ20	15	-	-	A	$V_{DS}>I_{D(on)} \times R_{DS(on)max}$ , $V_{GS}=10V$
	IRFZ22	14	-	-	A	
$g_{fs}$ Forward Transconductance	ALL	-	0.080	0.100	$\Omega$	$V_{GS}=10V$ , $f_p=9.0A$
$C_{iss}$ Input Capacitance	ALL	-	0.110	0.120	$\Omega$	
$C_{oss}$ Output Capacitance	ALL	5.0	6.0	-	S( $\Omega$ )	$V_{DS}>I_{D(on)} \times R_{DS(on)max}$ , $V_{GS}=9.0V$
$C_{rss}$ Reverse Transfer Capacitance	ALL	-	560	850	pF	$V_{GS}=0V$ , $V_{DS}=25V$ , $f=1.0MHz$
$t_{d(on)}$ Turn-On Delay Time	ALL	-	250	350	pF	See Fig. 10
$t_r$ Rise Time	ALL	-	60	100	pF	
$t_{d(off)}$ Turn-Off Delay Time	ALL	-	15	30	ns	$V_{D0}=25V$ , $I_D=9.0A$ , $Z_0=50\Omega$
$t_f$ Fall Time	ALL	-	45	90	ns	See Fig. 17
$Q_g$ Total Gate Charge (Gate-Source Plus Gate-Drain)	ALL	-	20	40	nC	(MOSFET switching times are essentially independent of operating temperature.)
$Q_{gs}$ Gate-Source Charge	ALL	-	15	30	nC	
$Q_{gd}$ Gate – Drain ("Miller") Charge	ALL	-	12	17	nC	$V_{GS}=10V$ , $I_D=20A$ , $V_{DS}=0.8\text{Max. Rating}$ .
$L_D$ Internal Drain Inductance	ALL	-	9.0	-	nC	See Fig. 18 for test circuit, (Gate charge is essentially independent of operating temperature.)
		-	3.0	-	nC	
$L_s$ Internal Source Inductance	ALL	-	3.5	-	nH	Measured from the contact screw on tab to center of dia
$L_s$		-	4.5	-	nH	Measured from the drain lead, 6mm (0.25 in.) from package to center of die.
		-	75	-	nH	Measured from the source lead, 6mm (0.25in.) from package to source bonding pad.



**Thermal Resistance**

$R_{thJC}$	Junction-to-Case	ALL	-	-	3.12	K/W	
$R_{thCS}$	Case-to-Sink	ALL	-	1.0	-	K/W	Mounting surface flat, smooth, and greased.
$R_{thJA}$	Junction-to-Ambient	ALL	-	-	80	K/W	Typical socket Mount

**Source-Drain Diode Ratings and Characteristics**

$I_S$	Continuous Source Current (Body Diode)	IRFZ20	-	-	15	A	Modified MOSFET symbol showing the integral reverse P-N junction rectifier. 
		IRFZ22	-	-	14	A	
$I_{SM}$	Pulse Source Current (Body Diode)	IRF20	-	-	60	A	
		IRF22	-	-	56	A	
$V_{SD}$	Diode Forward Voltage	IRF20	-	-	1.5	V	$T_C=25^\circ\text{C}$ , $I_S=15\text{A}$ , $V_{GS}=0\text{V}$
		IRF22	-	-	1.4	V	$T_C=25^\circ\text{C}$ , $I_S=14\text{A}$ , $V_{GS}=0\text{V}$
$t_{rr}$	Reverse Recovery Time	ALL	-	100	-	ns	$T_J=150^\circ\text{C}$ , $I_F=15\text{A}$ , $dI_F/dt=100\text{A}/\mu\text{s}$
$Q_{RR}$	Reverse Recovered Charge	ALL	-	0.4	-	$\mu\text{C}$	$T_J=150^\circ\text{C}$ , $I_F=15\text{A}$ , $dI_F/dt=100\text{A}/\mu\text{s}$
$t_{on}$	Forward Turn-on Time	ALL	Intrinsic turn-on time is negligible. Turn-on speed is substantially controlled by $L_S+L_D$				

 $T_J=25^\circ\text{C}$  to  $150^\circ\text{C}$ 

 Pulse Test: Pulse width  $\leq 300\mu\text{s}$ , Duty Cycle  $\leq 2\%$ .

Repetitive Rating: Pulse width limited by max. junction temperature.

See Transient Impedance Curve (Fig. 5).

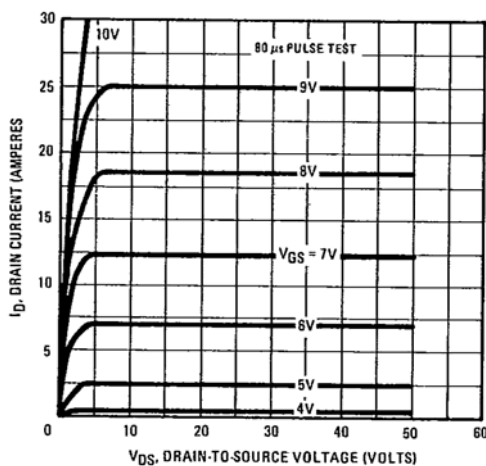
 $K/W = \text{ } /W$ 
 $W/K=W/$ 


Fig. 1-Typical Output Characteristics

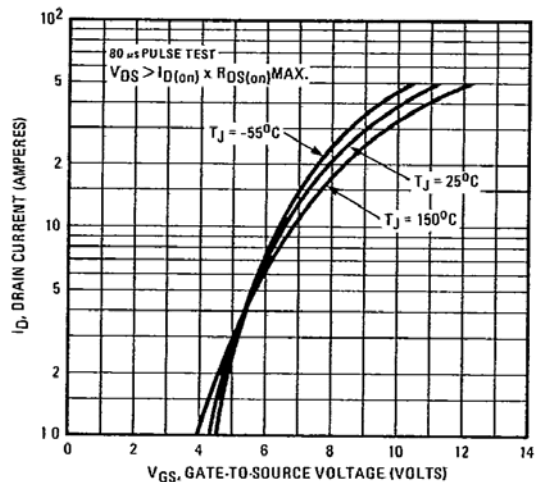


Fig. 2 -Typical Transfer Characteristics

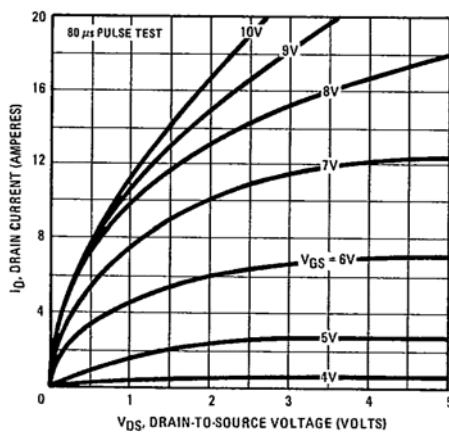


Fig. 3 -Typical Saturation Characteristics

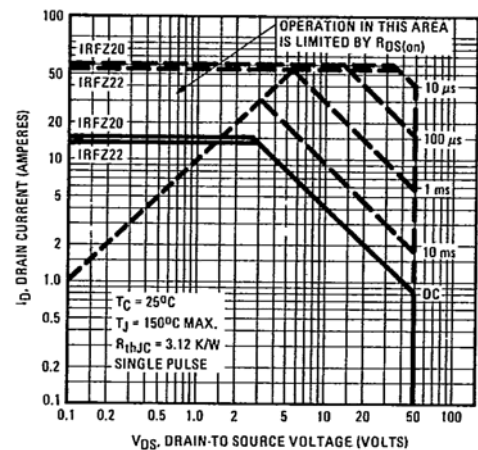


Fig. 4 - Maximum Safe Operating Area

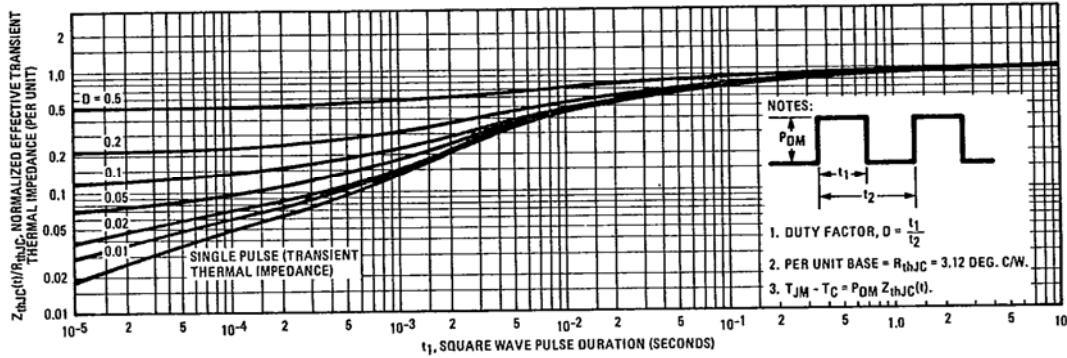


Fig. 5- Maximum Effective Transient Thermal Impedance, Junction-to-Case Vs. Pulse Duration

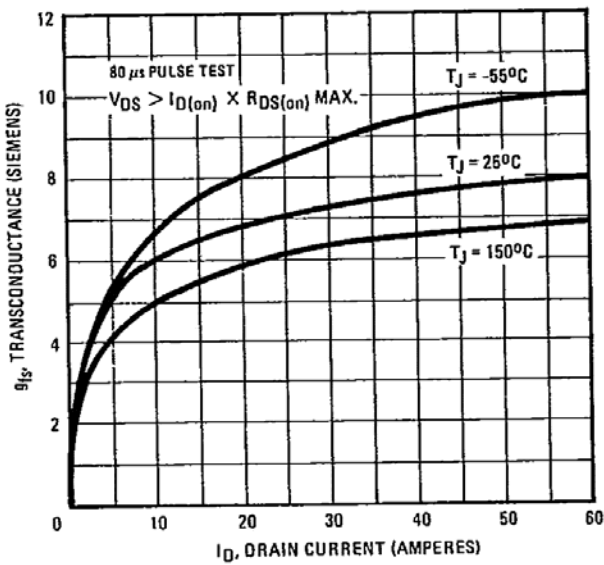


Fig. 6 Typical Transconductance Vs. Drain Current

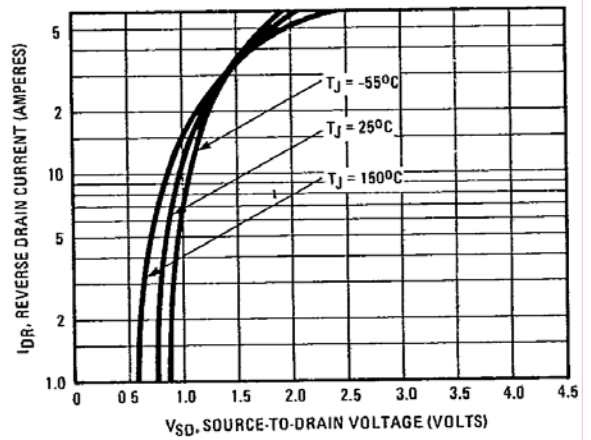


Fig. 7 Typical Source-Drain Diode Forward Voltage

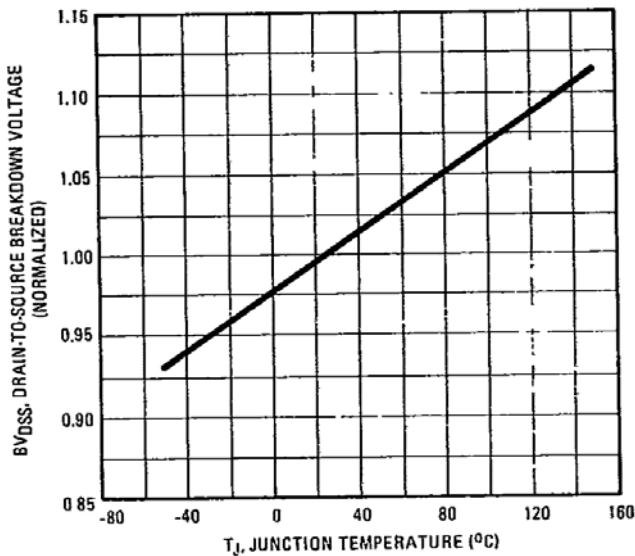


Fig. 8 – Breakdown Voltage Vs. Temperature

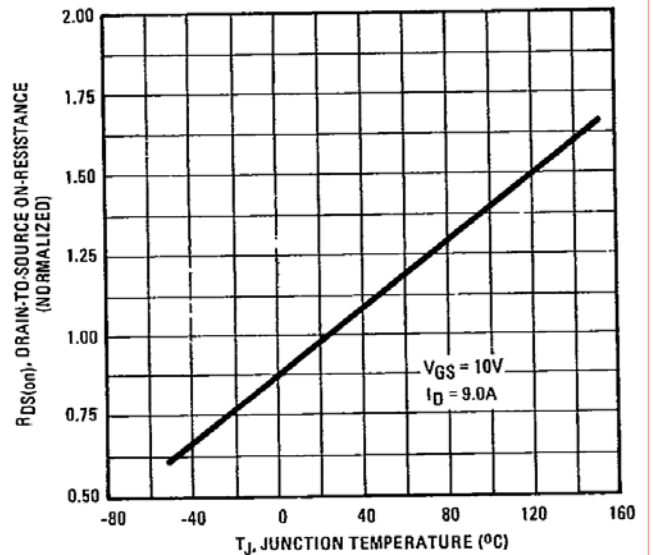


Fig.9 – Normalized On- Resistance Vs. Temperature

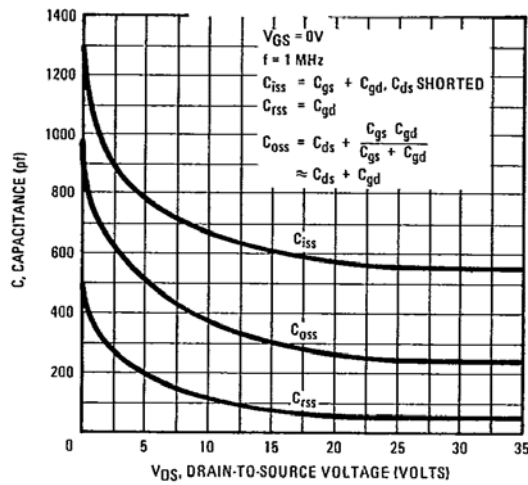


Fig. 10 - Typical Capacitance Vs. Drain-to-Source Voltage

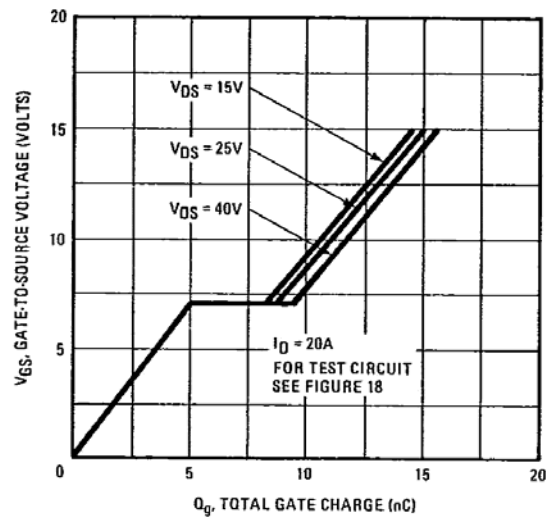


Fig. 11 - Typical Gate Charge Vs. Gate-to-Source Voltage

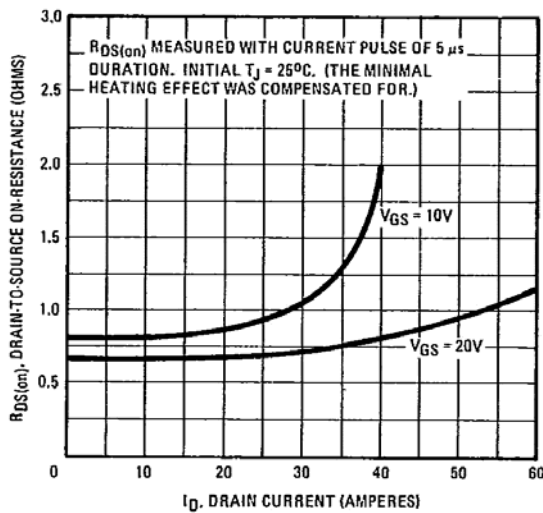


Fig. 12 - Typical On-Resistance Vs. Drain Current

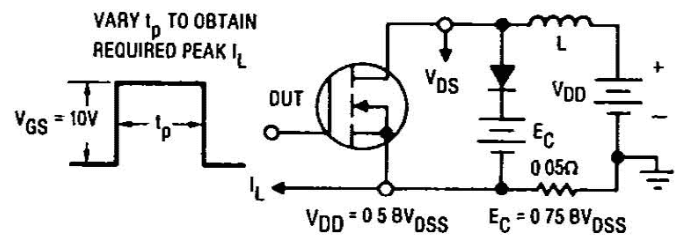


Fig. 15 - Clamped Inductive Test Circuit

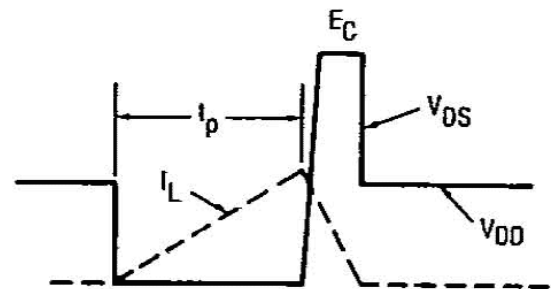


Fig. 16 - Clamped Inductive Waveforms

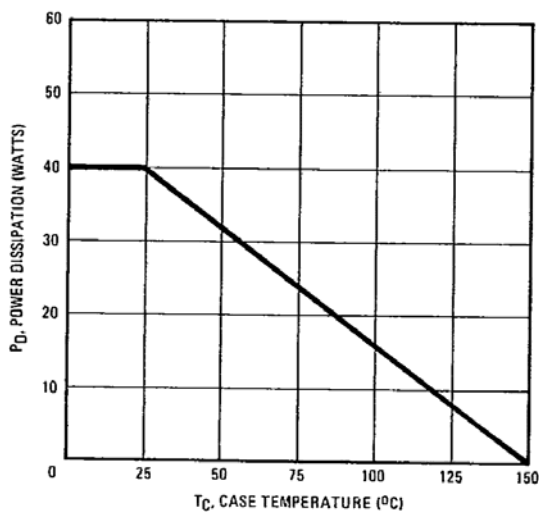


Fig. 14 - Power Vs. Temperature Derating Curve

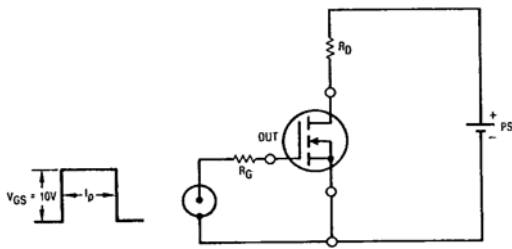


Fig. 17 – Switching Time Test Circuit

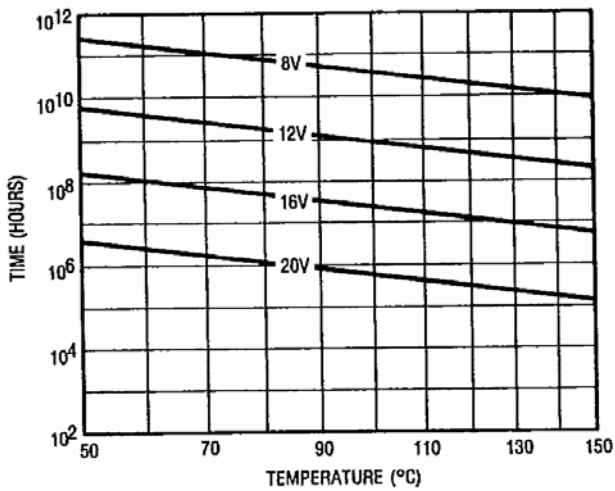


Fig. 19 – Typical Time to Accumulated 1% Failure

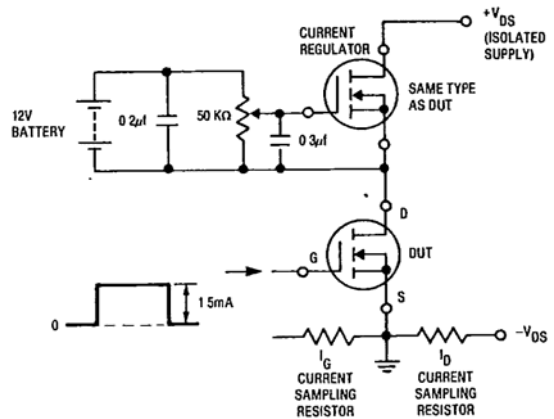


Fig. 18-Gate Charge Test Circuit

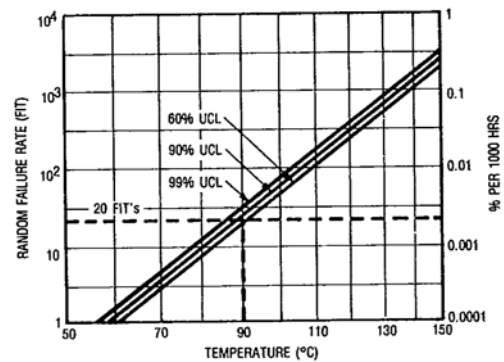


Fig. 20 – Typical High Temperature Reverse Bias (HTRB) Failure Rate