

Top View of Assembly

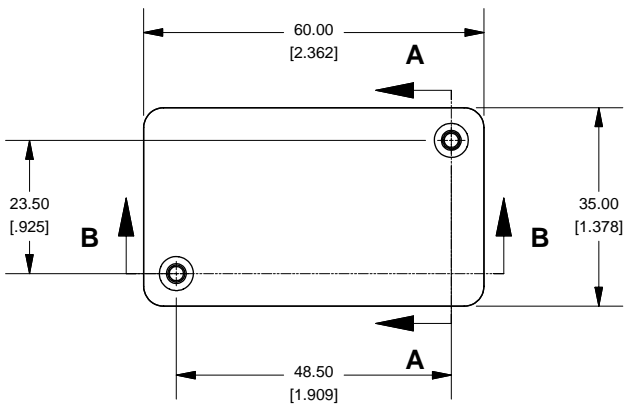

SECTION A-A End View of Assembly

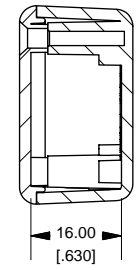

1551H (Basic)

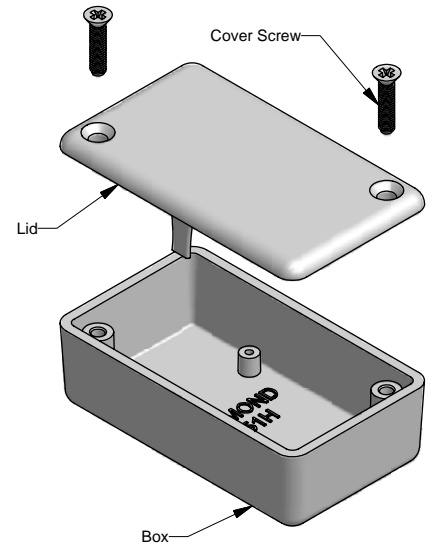

SECTION B-B Side View of Assembly

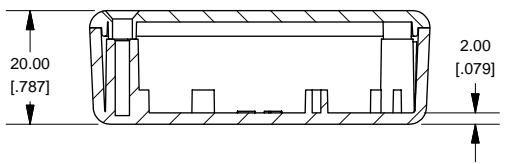

Top View Looking Inside Box

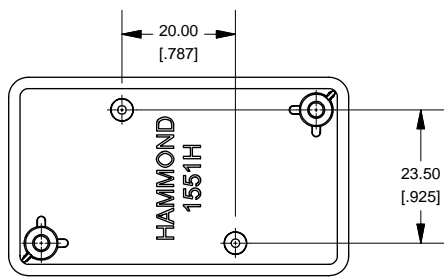

SECTION C-C Boss Heights

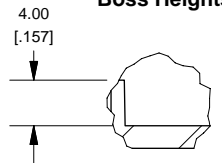

Maximum P.C. Board Size

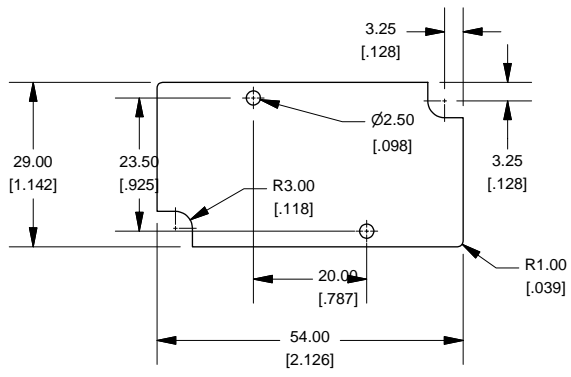

Note: Enclosure Lid may come with "gate" tab still intact. This tab is easily removed if necessary

Lid

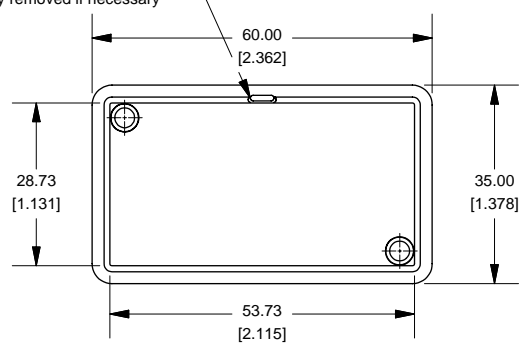

NOTE
Purchased assembly includes lid and box made from GP ABS material and cover screws.

1551H	
1551H Enclosure	
Black Enclosure - RAL 7011	1551HBK
Gray Enclosure - RAL 7035	1551HGY
ACCESSORIES	
Black Enclosure Cover Screws (Pkg 100) [#4 X 1/2" Self Tapping]	1591TS100BK
Gray Enclosure Cover Screws (Pkg 100) [#4 X 1/2" Self Tapping]	1591TS100
P.C. Board Screws [#2 X 3/16" Self-Tapping]	1551ATS100 (Pkg 100)



www.hammondmfg.com