



Technical Data Sheet

204-10USOC/S400-AX

Features

- Popular T-1 package.
- High efficiency.
- General purpose leads.
- Selected minimum intensities.
- Available on tape and reel.
- Pb free



Descriptions

- The series is specially designed for applications requiring higher brightness.
- The LED lamps are available with different colors, intensities, epoxy colors, etc.
- Superior performance in outdoor environment

Applications

- Status indicators.
- Commercial use.
- Advertising Signs.
- Back lighting.

Device Selection Guide

| LED Part No. | Chip | | Lens Color |
|--------------------|----------|---------------------|-------------|
| | Material | Emitted Color | |
| 204-10USOC/S400-A6 | AlGaInP | Super Sunset Orange | Water Clear |
| 204-10USOC/S400-A7 | | | |
| 204-10USOC/S400-A8 | | | |
| 204-10USOC/S400-A9 | | | |

Package Dimensions

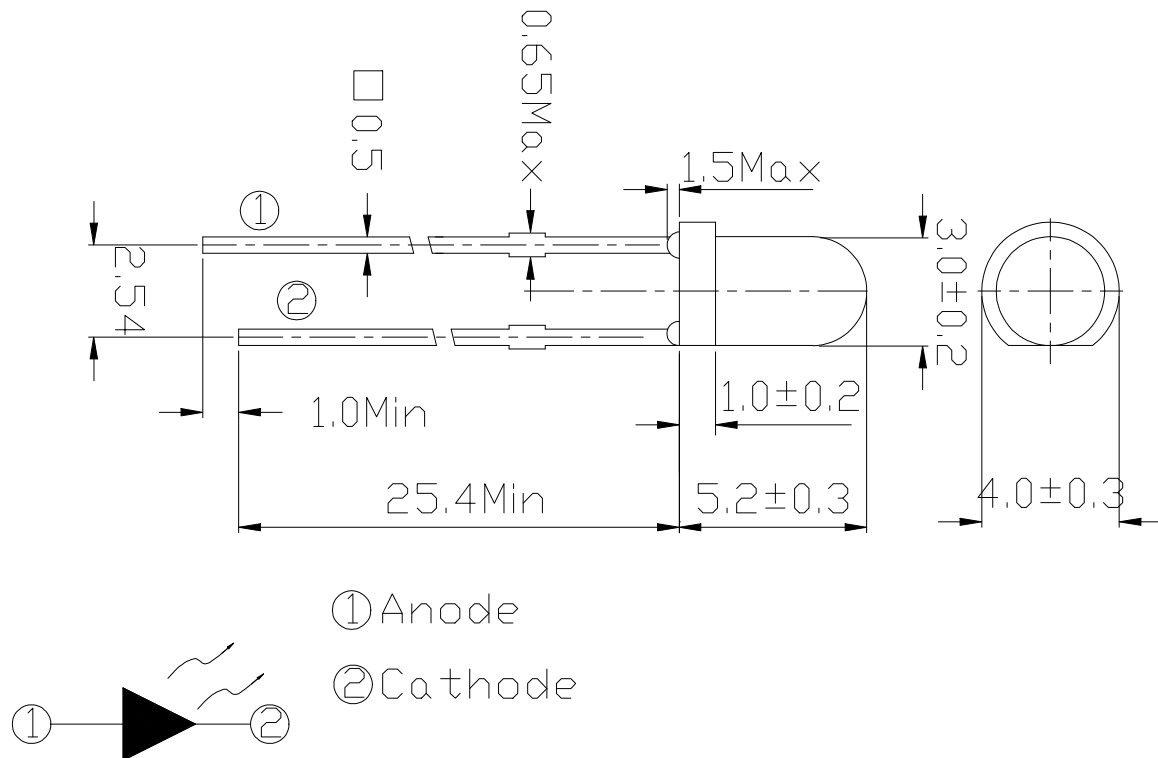

Notes:

- * Other dimensions are in millimeters, tolerance is 0.25mm except being specified.
- * Protruded resin under flange is 1.5mm Max LED.
- * Bare copper alloy is exposed at tie-bar portion after cutting.

Absolute Maximum Rating (T_a=25)

| Parameter | Symbol | Absolute Maximum Rating | Unit |
|---|------------------|-------------------------|------|
| Forward Current | I _F | 50 | mA |
| Pulse Forward Current (Duty 1/10@ 1KHz) | I _{FP} | 100 | mA |
| Operating Temperature | T _{opr} | -40 ~ +85 | |
| Storage Temperature | T _{stg} | -40 ~ +100 | |
| Electrostatic Discharge | ESD | 2000 | V |
| Soldering Temperature | T _{sol} | 260 ±5 | |
| Power Dissipation | P _d | 120 | mW |
| Reverse Voltage | V _R | 5 | V |

Notes: Soldering time 5 seconds.

Electro-Optical Characteristics (T_a=25)

| Parameter | Symbol | *Chip Rank | Min. | Typ. | Max. | Unit | Condition |
|---------------------|----------------|------------|------|------|------|------|----------------------|
| Luminous Intensity | I _v | A6 | 500 | 8000 | -- | mcd | I _F =20mA |
| | | A7 | 630 | 1000 | -- | | |
| | | A8 | 800 | 1250 | -- | | |
| | | A9 | 1000 | 1600 | -- | | |
| Viewing Angle | 2 1/2 | -- | -- | 30 | -- | deg | |
| Peak Wavelength | p | -- | -- | 621 | -- | nm | |
| Dominant Wavelength | d | -- | -- | 615 | -- | | |
| Spectrum Half width | | -- | -- | 18 | -- | | |
| Forward Voltage | V _F | -- | -- | 2.0 | 2.4 | V | |
| Reverse Current | I _R | -- | -- | -- | 10 | μ A | V _R =5V |

***204-10USOC/S400-AX**



Typical Electro-Optical Characteristics Curves

Relative Intensity vs. Wavelength

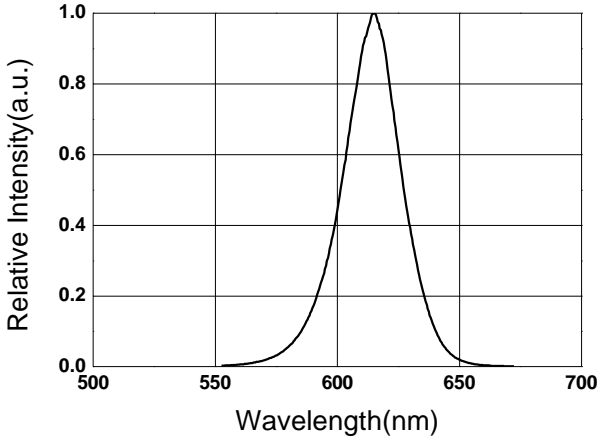

Forward Current vs. Forward Voltage

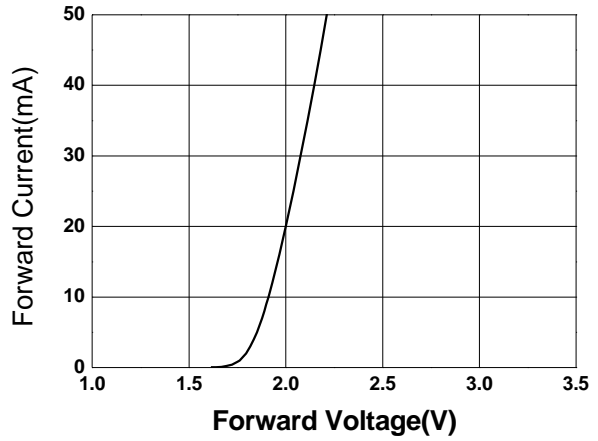

Relative Intensity vs. Ambient Temp

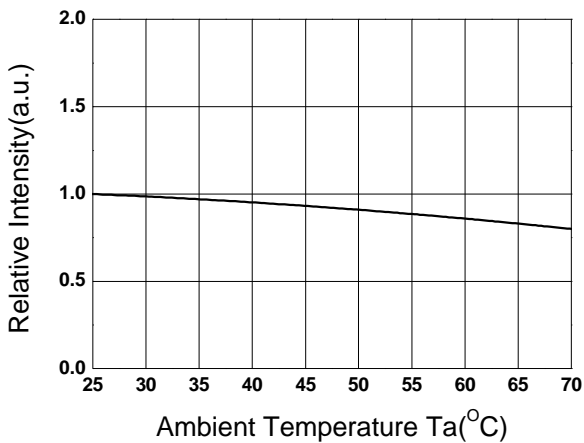

Forward Current vs. Relative Intensity

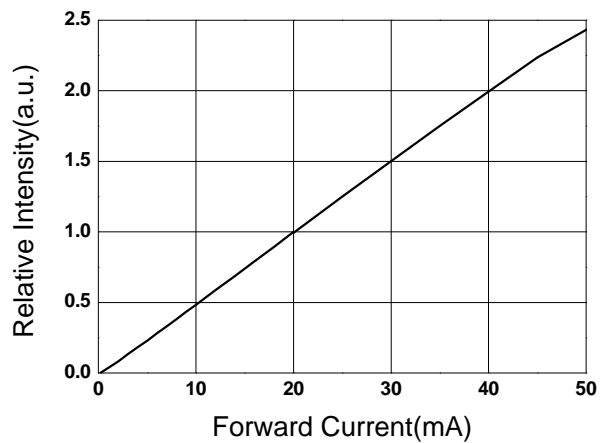

Forward Current vs. Ambient Temp.

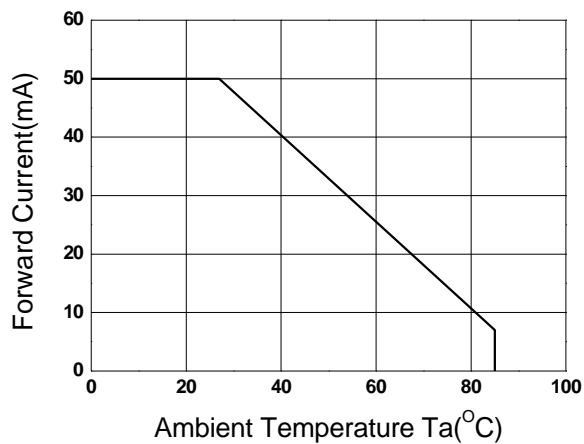

Radiation Characteristics

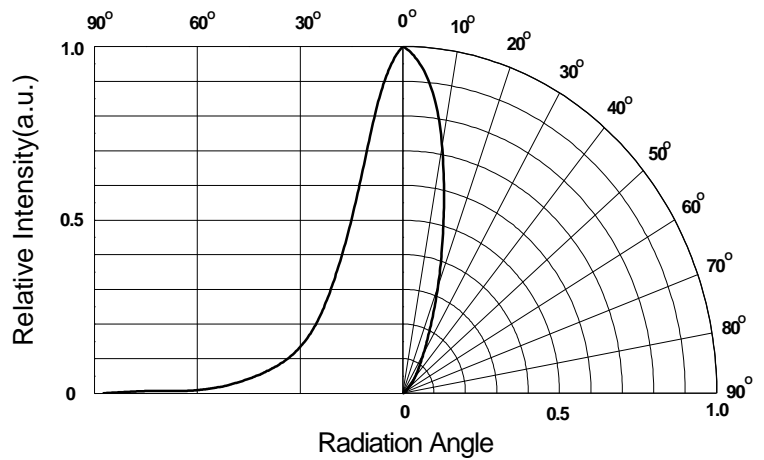



204-10USOC/S400-AX

Packing Quantity Specification

- 1.1000PCS/1Bag , 4Bags/1Box
- 2.10Boxes/1Carton

Label Form Specification

| | |
|--------------------|------|
| | |
| CPN: | |
| P/N: | |
| | |
| 204-10USOC/S400-AX | |
| QTY : | CAT: |
| | |
| LOT NO : | HUE: |
| | |
| MADE IN TAIWAN | |

- CPN: Customer's Production Number
- P/N : Production Number
- 204-10USOC/S400-AX:Production name
- QTY: Packing Quantity
- CAT: Ranks of Luminous and Forward Voltage
- HUE: Ranks of Dominant Wavelength
- REF: Reference
- LOT No: Lot Number
- MADE IN TAIWAN: Production Place

Notes

1. Above specification may be changed without notice. EVERLIGHT will reserve authority on material change for above specification.
2. When using this product, please observe the absolute maximum ratings and the instructions for using outlined in these specification sheets. EVERLIGHT assumes no responsibility for any damage resulting from use of the product which does not comply with the absolute maximum ratings and the instructions included in these specification sheets.
3. These specification sheets include materials protected under copyright of EVERLIGHT corporation. Please don't reproduce or cause anyone to reproduce them without EVERLIGHT's consent.

| | |
|---|--|
| EVERLIGHT ELECTRONICS CO., LTD. Office: No 25, Lane 76, Sec 3, Chung Yang Rd, Tucheng, Taipei 236, Taiwan, R.O.C | Tel: 886-2-2267-2000, 2267-9936 Fax: 886-2267-6244, 2267-6189, 2267-6306 http://www.everlight.com |
|---|--|