

# Technical Data Sheet

## HIGH POWER LED

**30-01UYC**

### Benefits

- . Fewer LEDs Required
- . Lowers Lighting System Cost
- . Viewing angle 70°

### Features

- . High Flux Output.
- . Designed for High Current Operation.
- . Low Thermal Resistance.
- . Low Profile.
- . Packaged in Tubes for Use with Automatic Insertion Equipment.
- . Pb free.



### Descriptions

This revolutionary package design allows the light designer to reduce the number of LEDs required and provide a more uniform and unique illuminated appearance than with other LED solutions. This is possible through the efficient optical package design and high-current capabilities.

The low profile package can be easily coupled with reflectors or lenses to efficiently distribute light and provide the desired light appearance.

### Applications

- . Automotive Exterior Lighting
- . Electronic Signs and Signals
- . Special Lighting application

### Device Selection Guide

PART NO.	Chip		Lens Color
	Material	Emitted Color	
30-01UYC	AlGaInP	Super Yellow	Water Clear

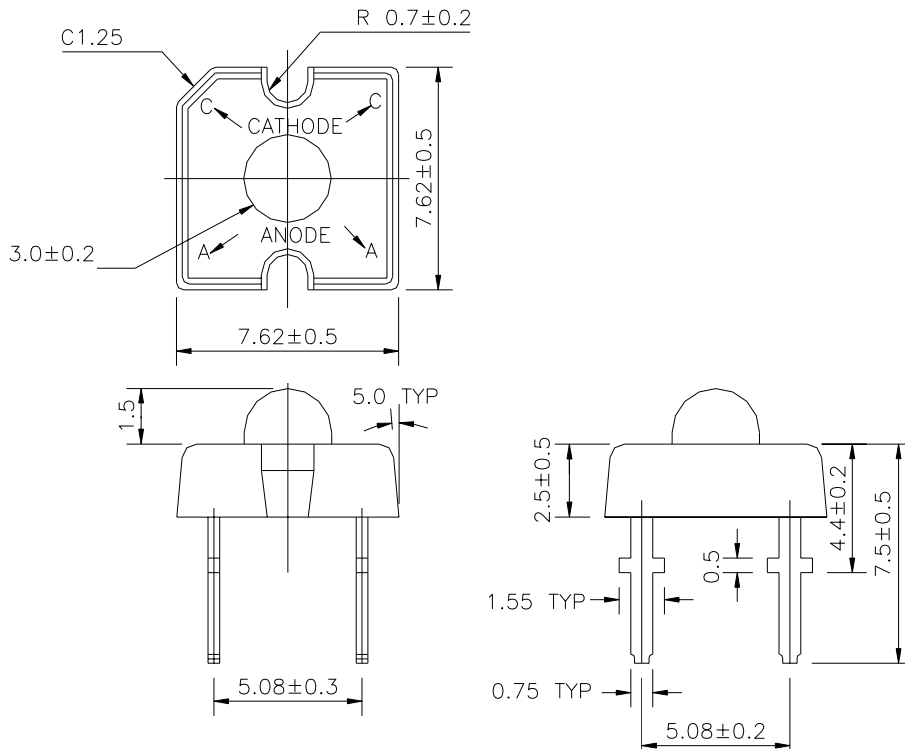
**Package Dimensions**

**Notes:** 1.All dimensions are in millimeters

2.An epoxy meniscus may extend about 1.5mm(0.059") down the leads

3.Tolerances unless dimensions  $\pm 0.25$ mm

**Absolute Maximum Ratings (Ta=25°C)**

Parameter	Symbol	Rating	Units
Continuous Forward Current	$I_F$	70	mA
Peak Forward Current(Duty 1/10 @ 1KHZ)	$I_{FP}$	160	mA
Reverse Voltage	$V_R$	5	V
Operating Temperature	$T_{opr}$	-40 ~ +85	°C
Storage Temperature	$T_{stg}$	-40 ~ +100	°C
Soldering Temperature(T=5 sec)	$T_{sol}$	$260 \pm 5$	°C
LED Junction Temperature	$T_j$	115	°C
Power Dissipation	$P_d$	220	mW
Electrostatic Discharge	ESD	2000	V

**Electro-Optical Characteristics (Ta=25°C)**

Parameter	Symbol	Min.	Typ.	Max.	Condition	Unit
Total Flux	$\Phi_v$	990	1440	----	I <sub>F</sub> =70mA	mlm
Viewing Angle	$2\theta_{1/2}$	----	70	----	I <sub>F</sub> =70mA	deg
Peak Wavelength	$\lambda_p$	----	591	----	I <sub>F</sub> =20mA	nm
Dominant Wavelength	$\lambda_d$	----	589	----	I <sub>F</sub> =20mA	nm
Spectrum Radiation Bandwidth	$\Delta\lambda$	----	15	----	I <sub>F</sub> =20mA	nm
Forward Voltage	V <sub>F</sub>	----	2.4	----	I <sub>F</sub> =70mA	V
Reverse Current	I <sub>R</sub>	----	----	10	V <sub>R</sub> =5V	uA

**Rank**

30-01UYC

□	□	□
(1)	(2)	(3)

(1) V <sub>F</sub> (V)			(2) $\lambda_d$ (nm)			(3) $\Phi_v$ (mlm)		
Bin	Min	Max	Bin	Min	Max	Bin	Min	Max
0	1.95	2.19	1	585	591	W	990	1760
1	2.07	2.31	2	589	594	X	1440	2750
2	2.19	2.43	3	592	597	Y	2250	4100
3	2.31	2.55						
4	2.43	2.67						
5	2.55	2.79						
6	2.67	2.91						
7	2.79	3.03						
8	2.91	3.15						

\*Measurement Uncertainty of Forward Voltage : ±0.1V

\*Measurement Uncertainty of Luminous Intensity: ±15%

**Typical Electro-Optical Characteristics Curves**

**Relative Intensity vs. Wavelength**

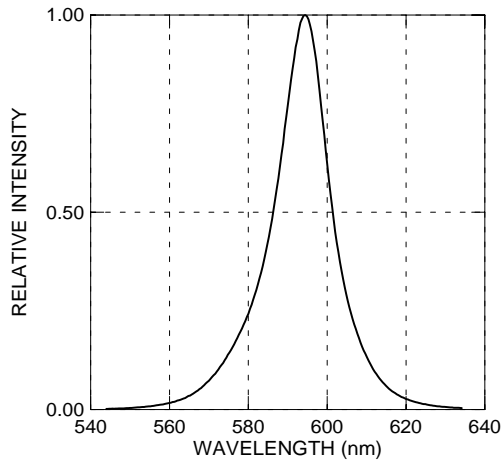

**Forward Current vs. Forward Voltage**

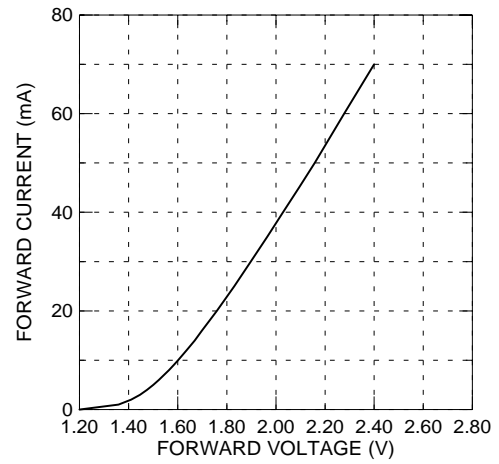

**Relative Intensity vs. Forward Current**

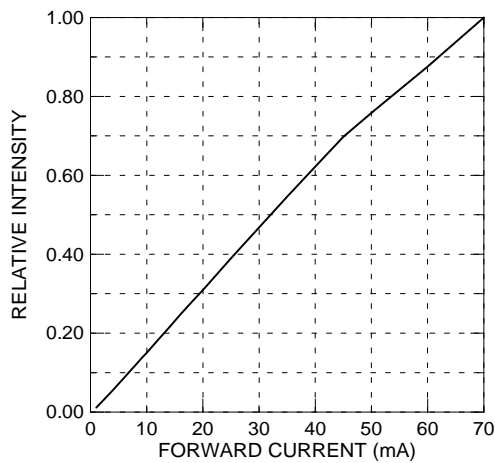

**Forward Current vs. Ambient Temp.**

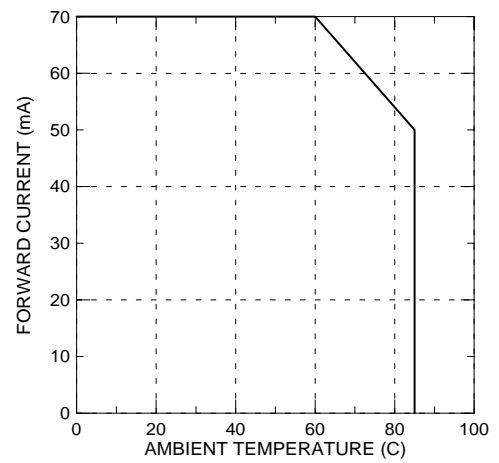

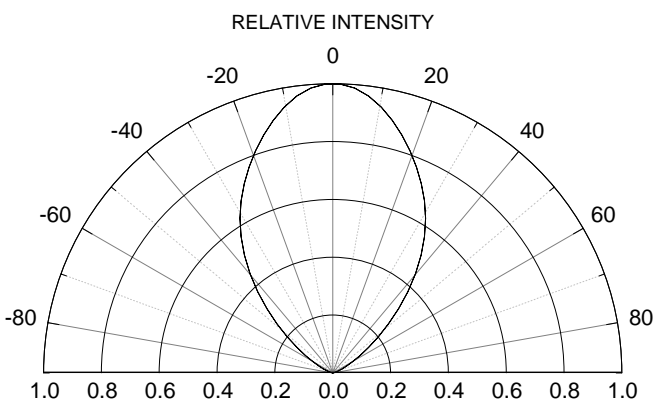

**Relative Intensity vs. Angle Displacement**

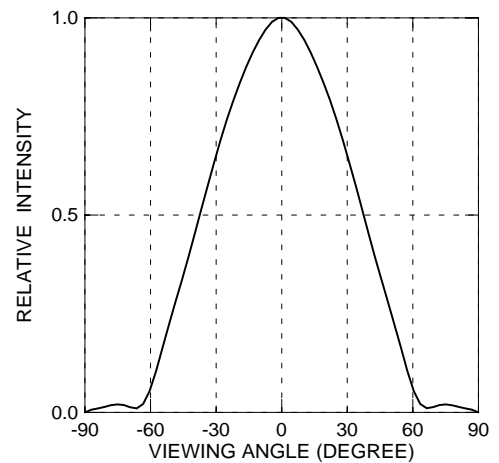

**Relative Intensity vs. Off Axis Angle**



**Label Form Specification**

<b>EVERLIGHT</b>	
CPN:	
P/N:	
	
30-01UYC	
QTY :	CAT:
	HUE:
LOT NO :	REF:
	
MADE IN TAIWAN	

CPN: Customer's Production Number  
P/N : Production Number  
QTY: Packing Quantity  
CAT: Ranks  
HUE: Space  
REF: Reference  
LOT No: Lot Number  
MADE IN TAIWAN: Production Place

**Notes**

1. Above specification may be changed without notice. EVERLIGHT will reserve authority on material change for above specification.
2. When using this product, please observe the absolute maximum ratings and the instructions for using outlined in these specification sheets. EVERLIGHT assumes no responsibility for any damage resulting from use of the product which does not comply with the absolute maximum ratings and the instructions included in these specification sheets.
3. These specification sheets include materials protected under copyright of EVERLIGHT corporation. Please don't reproduce or cause anyone to reproduce them without EVERLIGHT's consent.

<b>EVERLIGHT ELECTRONICS CO., LTD.</b> Office: No 25, Lane 76, Sec 3, Chung Yang Rd, Tucheng, Taipei 236, Taiwan, R.O.C	Tel: 886-2-2267-2000, 2267-9936 Fax: 886-2267-6244, 2267-6189, 2267-6306 <a href="http://www.everlight.com">http://www.everlight.com</a>
-------------------------------------------------------------------------------------------------------------------------------	------------------------------------------------------------------------------------------------------------------------------------------------