



# Technical Data Sheet

## 5484B/R3DC-AEGC/X/MS

### Features

- High luminous intensity output
- Oval Shape
- Well defined spatial radiation
- Wide viewing angle ( $2\theta_{1/2}$ ) :  $110^\circ / 40^\circ$
- UV resistant epoxy
- The product itself will remain within RoHS compliant version



### Descriptions

- This precision optical performance oval LED is specifically designed for passenger information signs
- This lamp has matched radiation patterns with yellow, blue or green mixing color applications

### Applications

- Color graphic signs
- Message boards
- Variable message signs (VMS)
- Commercial outdoor advertising

### Device Selection Guide

LED Part No.	Chip Material	Emitted Color	Lens Color	Stopper
5484B/R3DC-AEGC/MS	AlGaInP	Brilliant Red	Red Diffused	No
5484B/R3DC-AEGC/P/MS				Yes





# Technical Data Sheet

## 5484B/R3DC-AEGC/X/MS

### Absolute Maximum Rating ( $T_a=25^{\circ}\text{C}$ )

Parameter	Symbol	Absolute Maximum Rating	Unit
Forward Current	$I_F$	50	mA
Pulse Forward Current (Duty1/10@ 1KHz)	$I_{FP}$	160	mA
Operating Temperature	$T_{opr}$	-40 ~ +85	$^{\circ}\text{C}$
Storage Temperature	$T_{stg}$	-40 ~ +100	$^{\circ}\text{C}$
Soldering Temperature	$T_{sol}$	260	$^{\circ}\text{C}$
Power Dissipation	$P_d$	120	mW
Reverse Voltage	$V_R$	5	V

Notes: Soldering time  $\leq 5$  seconds.

### Electro-Optical Characteristics ( $T_a=25^{\circ}\text{C}$ )

Parameter	Symbol	Min.	Typ.	Max.	Unit	Condition
Luminous Intensity	$I_V$	360	450	715	mcd	$I_F=20\text{mA}$
Viewing Angle	$2\theta_{1/2}$	--	X:110Y:40	--	deg	
Peak Wavelength	$\lambda_p$	--	635	--	nm	
Dominant Wavelength	$\lambda_d$	622	628	634		
Spectrum Half width	$\Delta\lambda$	--	20	--		
Forward Voltage	$V_F$	2.0	2.3	2.6	V	
Reverse Current	$I_R$	--	--	10	$\mu\text{A}$	$V_R=5\text{V}$

### Rank Combination ( $I_F=20\text{mA}$ )

Rank	E	F	G
Luminous Intensity	360~450	450~565	565~715

\*Measurement Uncertainty of Luminous Intensity:  $\pm 15\%$

Unit:mcd

Rank	2	3	4
Forward Voltage	2.0~2.2	2.2~2.4	2.4~2.6

\*Measurement Uncertainty of Forward Voltage:  $\pm 0.1\text{V}$

Unit:V

Rank	2	3	4
Dominant Wavelength	622~626	626~630	630~634

\*Measurement Uncertainty of Dominant Wavelength  $\pm 1.0\text{nm}$

Unit:nm

### Typical Electro-Optical Characteristics Curves

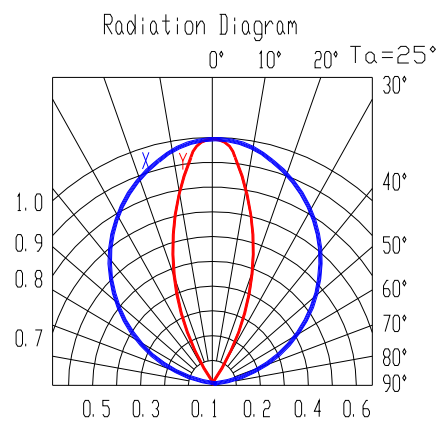
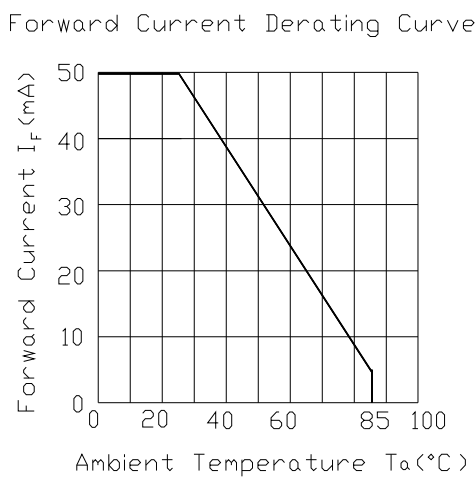
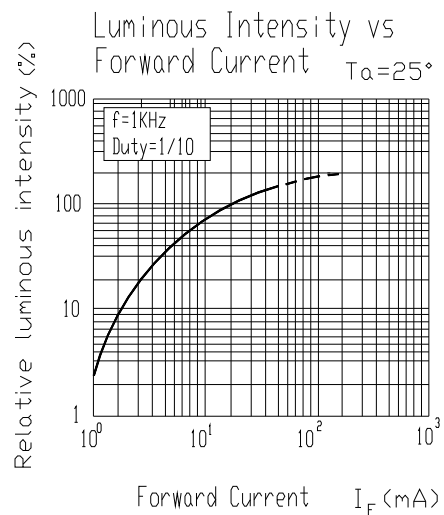
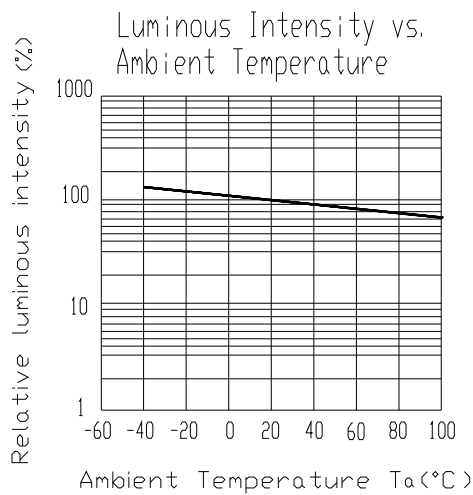
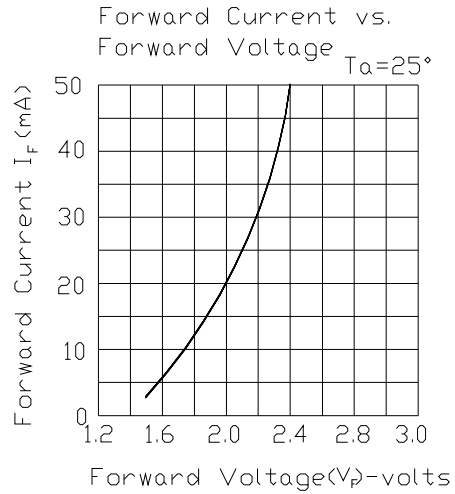
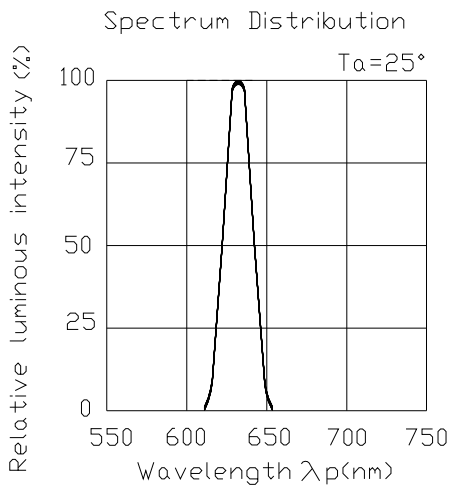

### Packing Specification

■ Anti-electrostatic bag

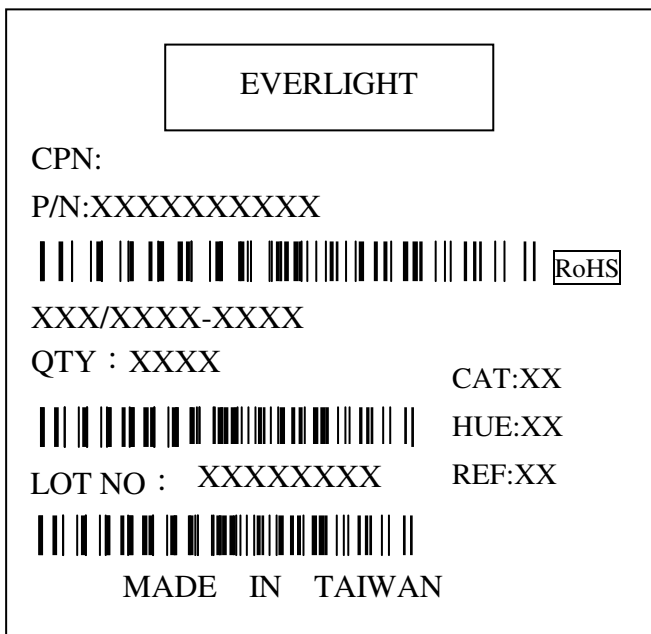
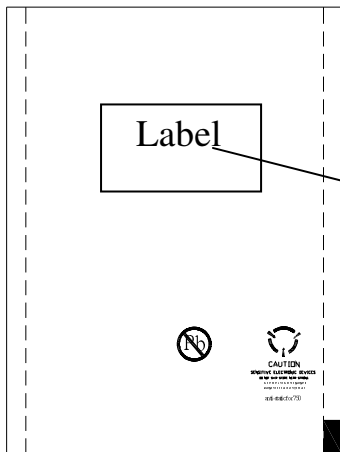

■ Inner Carton

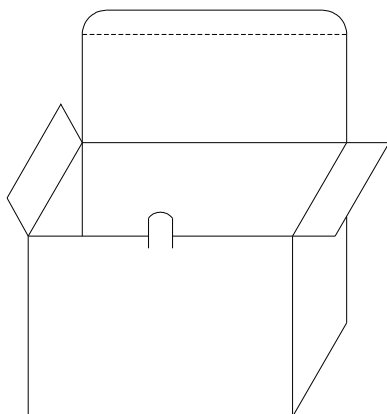

■ Label Form Specification

CPN: Customer's Production Number

P/N : Production Number

QTY: Packing Quantity

CAT: Ranks of Luminous Intensity and Forward Voltage

HUE: Rank of Dominant Wavelength

REF: Reference

LOT No: Lot Number

MADE IN TAIWAN: Production Place

■ Outside Carton

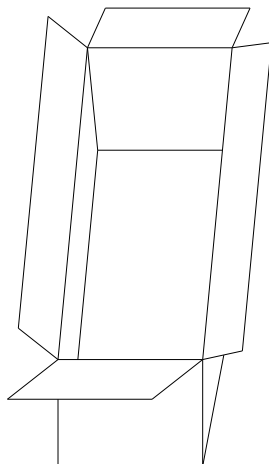

■ Packing Quantity

1. 500 PCS/1 Bag , 5 Bags/1 Inner Carton

2. 10 Inner Cartons/1 Outside Carton



# Technical Data Sheet

---

## 5484B/R3DC-AEGC/X/MS

### Notes

#### 1. Lead Forming

- During lead formation, the leads should be bent at a point at least 3mm from the base of the epoxy bulb.
- Lead forming should be done before soldering.
- Avoid stressing the LED package during leads forming. The stress to the base may damage the LED's characteristics or it may break the LEDs.
- Cut the LED leadframes at room temperature. Cutting the leadframes at high temperatures may cause failure of the LEDs.
- When mounting the LEDs onto a PCB, the PCB holes must be aligned exactly with the lead position of the LED. If the LEDs are mounted with stress at the leads, it causes deterioration of the epoxy resin and this will degrade the LEDs.

#### 2. Storage

- The LEDs should be stored at 30°C or less and 70%RH or less after being shipped from Everlight and the storage life limits are 3 months. If the LEDs are stored for 3 months or more, they can be stored for a year in a sealed container with a nitrogen atmosphere and moisture absorbent material.
- Please avoid rapid transitions in ambient temperature, especially, in high humidity environments where condensation can occur.

#### 3. Soldering

- Careful attention should be paid during soldering. When soldering, leave more than 3mm from solder joint to epoxy bulb, and soldering beyond the base of the tie bar is recommended.
- Recommended soldering conditions:

Hand Soldering		DIP Soldering	
Temp. at tip of iron	300°C Max. (30W Max.)	Preheat temp.	100°C Max. (60 sec Max.)
Soldering time	3 sec Max.	Bath temp. & time	260 Max., 5 sec Max
Distance	3mm Min.(From solder joint to epoxy bulb)	Distance	3mm Min. (From solder joint to epoxy bulb)

## 5484B/R3DC-AEGC/X/MS

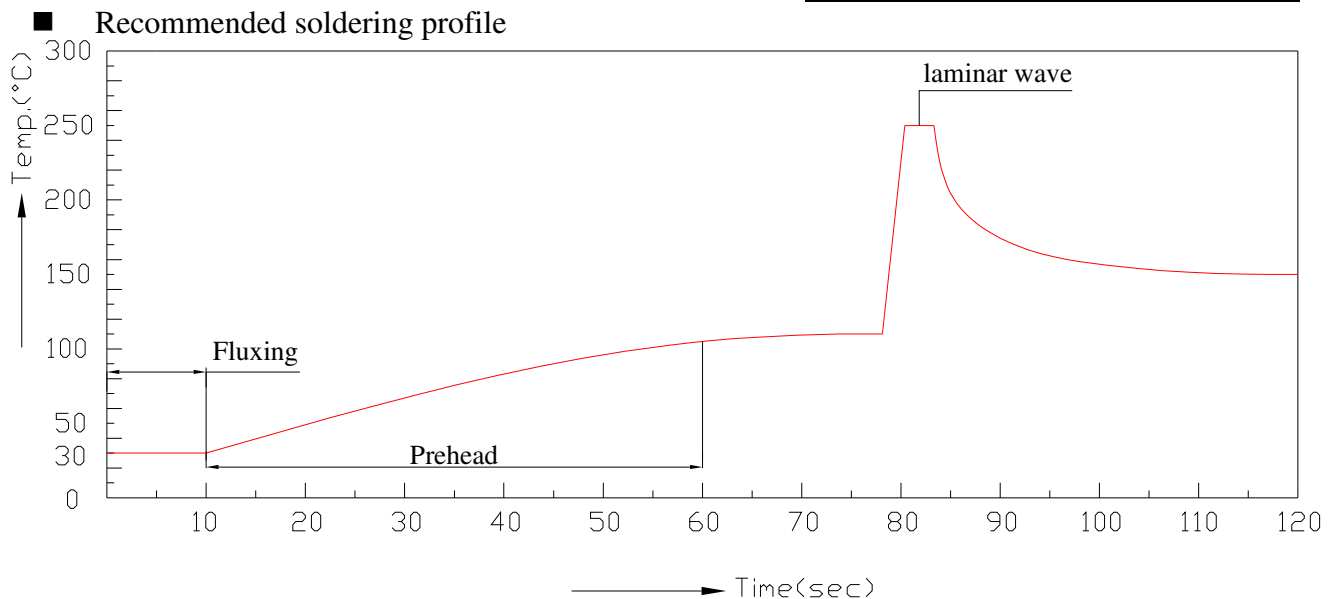

- Avoiding applying any stress to the lead frame while the LEDs are at high temperature particularly when soldering.
- Dip and hand soldering should not be done more than one time
- After soldering the LEDs, the epoxy bulb should be protected from mechanical shock or vibration until the LEDs return to room temperature.
- A rapid-rate process is not recommended for cooling the LEDs down from the peak temperature.
- Although the recommended soldering conditions are specified in the above table, dip or handsoldering at the lowest possible temperature is desirable for the LEDs.
- Wave soldering parameter must be set and maintain according to recommended temperature and dwell time in the solder wave.

#### 4. Cleaning

- When necessary, cleaning should occur only with isopropyl alcohol at room temperature for a duration of no more than one minute. Dry at room temperature before use.
- Do not clean the LEDs by the ultrasonic. When it is absolutely necessary, the influence of ultrasonic cleaning on the LEDs depends on factors such as ultrasonic power and the assembled condition. Ultrasonic cleaning shall be pre-qualified to ensure this will not cause damage to the LED



## Technical Data Sheet

---

### 5484B/R3DC-AEGC/X/MS

#### 5. Heat Management

- Heat management of LEDs must be taken into consideration during the design stage of LED application. The current should be de-rated appropriately by referring to the de-rating curve found in each product specification.
- The temperature surrounding the LED in the application should be controlled. Please refer to the data sheet de-rating curve.

#### 6. ESD (Electrostatic Discharge)

- Electrostatic discharge (ESD) or surge current (EOS) can damage LEDs.
- An ESD wrist strap, ESD shoe strap or antistatic gloves must be worn whenever handling LEDs.
- All devices, equipment and machinery must be properly grounded.
- Use ion blower to neutralize the static charge which might have built up on surface of the LEDs plastic lens as a result of friction between LEDs during storage and handing.

#### 7. Other

- Above specification may be changed without notice. EVERLIGHT will reserve authority on material change for above specification.
- When using this product, please observe the absolute maximum ratings and the instructions for using outlined in these specification sheets. EVERLIGHT assumes no responsibility for any damage resulting from use of the product which does not comply with the absolute maximum ratings and the instructions included in these specification sheets.
- These specification sheets include materials protected under copyright of EVERLIGHT corporation. Please don't reproduce or cause anyone to reproduce them without EVERLIGHT's consent.

**EVERLIGHT ELECTRONICS CO., LTD.**  
Office: No 25, Lane 76, Sec 3, Chung Yang Rd,  
Tucheng, Taipei 236, Taiwan, R.O.C

Tel: 886-2-2267-2000, 2267-9936  
Fax: 886-2267-6244, 2267-6189, 2267-6306  
<http://www.everlight.com>