

IGBT

Preliminary data

- Low forward voltage drop
- High switching speed
- Low tail current
- Latch-up free
- Avalanche rated

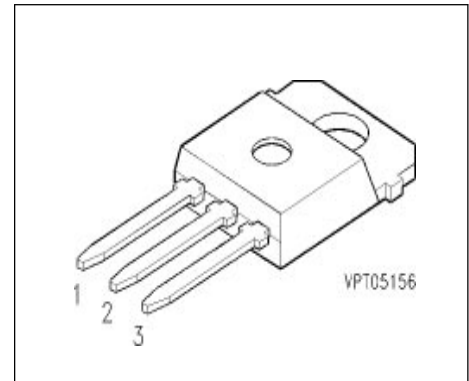

| Pin 1 | Pin 2 | Pin 3 |
|-------|-------|-------|
| G | C | E |

| Type | V_{CE} | I_C | Package | Ordering Code |
|---------|----------|-------|-----------|-----------------|
| BUP 313 | 1200V | 32A | TO-218 AB | Q67040-A4208-A2 |

Maximum Ratings

| Parameter | Symbol | Values | Unit |
|--------------------------------------------------------------------------------------------------------------------------------------------------------------------------------------|-------------|---------------|------------------|
| Collector-emitter voltage | V_{CE} | 1200 | V |
| Collector-gate voltage $R_{GE} = 20 \text{ k}\Omega$ | V_{CGR} | 1200 | |
| Gate-emitter voltage | V_{GE} | ± 20 | |
| DC collector current $T_C = 25 \text{ }^\circ\text{C}$ $T_C = 90 \text{ }^\circ\text{C}$ | I_C | 32 20 | A |
| Pulsed collector current, $t_p = 1 \text{ ms}$ $T_C = 25 \text{ }^\circ\text{C}$ $T_C = 90 \text{ }^\circ\text{C}$ | I_{Cpuls} | 64 40 | |
| Avalanche energy, single pulse $I_C = 15 \text{ A}$, $V_{CC} = 50 \text{ V}$, $R_{GE} = 25 \text{ }\Omega$ $L = 200 \text{ }\mu\text{H}$, $T_j = 25 \text{ }^\circ\text{C}$ | E_{AS} | 22 | mJ |
| Power dissipation $T_C = 25 \text{ }^\circ\text{C}$ | P_{tot} | 200 | W |
| Chip or operating temperature | T_j | -55 ... + 150 | $^\circ\text{C}$ |
| Storage temperature | T_{stg} | -55 ... + 150 | |

Maximum Ratings

| Parameter | Symbol | Values | Unit |
|-------------------------------------|--------|---------------|------|
| DIN humidity category, DIN 40 040 | - | E | - |
| IEC climatic category, DIN IEC 68-1 | - | 55 / 150 / 56 | |

Thermal Resistance

| | | | |
|-------------------------------|------------|-------------|-----|
| Thermal resistance, chip case | R_{thJC} | ≤ 0.63 | K/W |
|-------------------------------|------------|-------------|-----|

Electrical Characteristics, at $T_j = 25\text{ }^\circ\text{C}$, unless otherwise specified

| Parameter | Symbol | Values | | | Unit |
|-----------|--------|--------|------|------|------|
| | | min. | typ. | max. | |

Static Characteristics

| | | | | | |
|----------------------------------------------------------------------------------------------------------------------|---------------|-----|-----|-----|----|
| Gate threshold voltage $V_{GE} = V_{CE}, I_C = 0.35\text{ mA}$ | $V_{GE(th)}$ | 4.5 | 5.5 | 6.5 | V |
| Collector-emitter saturation voltage $V_{GE} = 15\text{ V}, I_C = 15\text{ A}, T_j = 25\text{ }^\circ\text{C}$ | $V_{CE(sat)}$ | - | 2.7 | 3.2 | |
| $V_{GE} = 15\text{ V}, I_C = 15\text{ A}, T_j = 125\text{ }^\circ\text{C}$ | | - | 3.3 | 3.9 | |
| $V_{GE} = 15\text{ V}, I_C = 30\text{ A}, T_j = 25\text{ }^\circ\text{C}$ | | - | 3.4 | - | |
| $V_{GE} = 15\text{ V}, I_C = 30\text{ A}, T_j = 125\text{ }^\circ\text{C}$ | | - | 4.3 | - | |
| Zero gate voltage collector current $V_{CE} = 1200\text{ V}, V_{GE} = 0\text{ V}, T_j = 25\text{ }^\circ\text{C}$ | I_{CES} | - | - | 0.8 | mA |
| Gate-emitter leakage current $V_{GE} = 25\text{ V}, V_{CE} = 0\text{ V}$ | I_{GES} | - | - | 100 | nA |

AC Characteristics

| | | | | | |
|-----------------------------------------------------------------------------------------------|-----------|---|------|------|----|
| Transconductance $V_{CE} = 20\text{ V}, I_C = 15\text{ A}$ | g_{fs} | - | 12 | - | S |
| Input capacitance $V_{CE} = 25\text{ V}, V_{GE} = 0\text{ V}, f = 1\text{ MHz}$ | C_{iss} | - | 1000 | 1350 | pF |
| Output capacitance $V_{CE} = 25\text{ V}, V_{GE} = 0\text{ V}, f = 1\text{ MHz}$ | C_{oss} | - | 150 | 225 | |
| Reverse transfer capacitance $V_{CE} = 25\text{ V}, V_{GE} = 0\text{ V}, f = 1\text{ MHz}$ | C_{rss} | - | 70 | 100 | |

Electrical Characteristics, at $T_j = 25\text{ °C}$, unless otherwise specified

| Parameter | Symbol | Values | | | Unit |
|-----------|--------|--------|------|------|------|
| | | min. | typ. | max. | |

Switching Characteristics, Inductive Load at $T_j = 125\text{ °C}$

| | | | | | |
|---------------------------------------------------------------------------------------------------------------------------|--------------|---|-----|-----|----|
| Turn-on delay time $V_{CC} = 600\text{ V}$, $V_{GE} = 15\text{ V}$, $I_C = 15\text{ A}$ $R_{Gon} = 82\ \Omega$ | $t_{d(on)}$ | - | 70 | 100 | ns |
| Rise time $V_{CC} = 600\text{ V}$, $V_{GE} = 15\text{ V}$, $I_C = 15\text{ A}$ $R_{Gon} = 82\ \Omega$ | t_r | - | 45 | 70 | |
| Turn-off delay time $V_{CC} = 600\text{ V}$, $V_{GE} = -15\text{ V}$, $I_C = 15\text{ A}$ $R_{Goff} = 82\ \Omega$ | $t_{d(off)}$ | - | 400 | 530 | |
| Fall time $V_{CC} = 600\text{ V}$, $V_{GE} = -15\text{ V}$, $I_C = 15\text{ A}$ $R_{Goff} = 82\ \Omega$ | t_f | - | 70 | 95 | |

Power dissipation

$$P_{\text{tot}} = f(T_C)$$

parameter: $T_j \leq 150^\circ\text{C}$

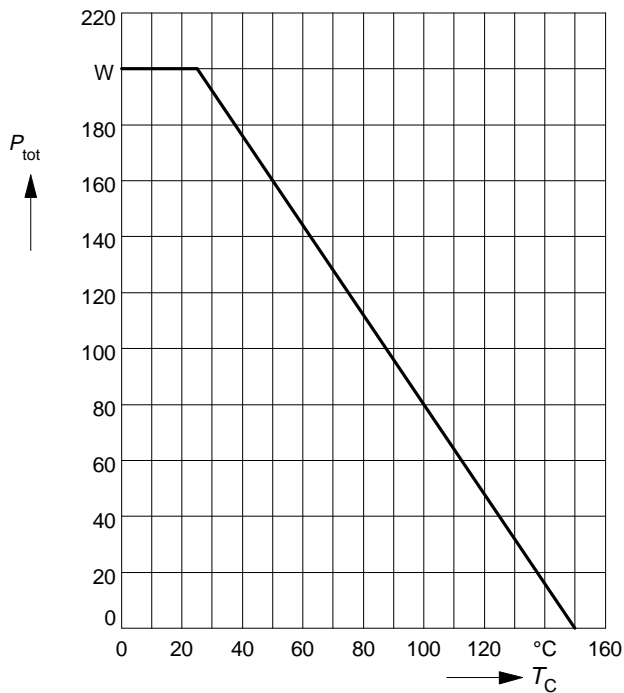

Collector current

$$I_C = f(T_C)$$

parameter: $V_{\text{GE}} \geq 15\text{ V}$, $T_j \leq 150^\circ\text{C}$

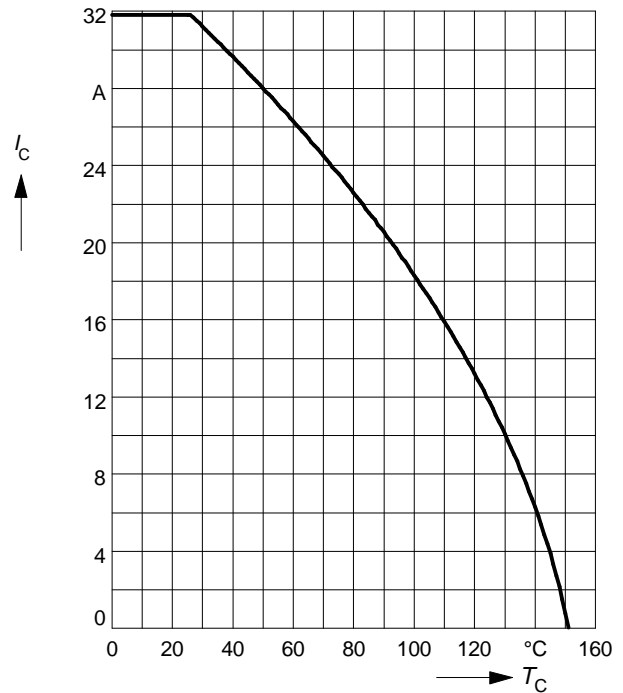

Safe operating area

$$I_C = f(V_{\text{CE}})$$

parameter: $D = 0$, $T_C = 25^\circ\text{C}$, $T_j \leq 150^\circ\text{C}$

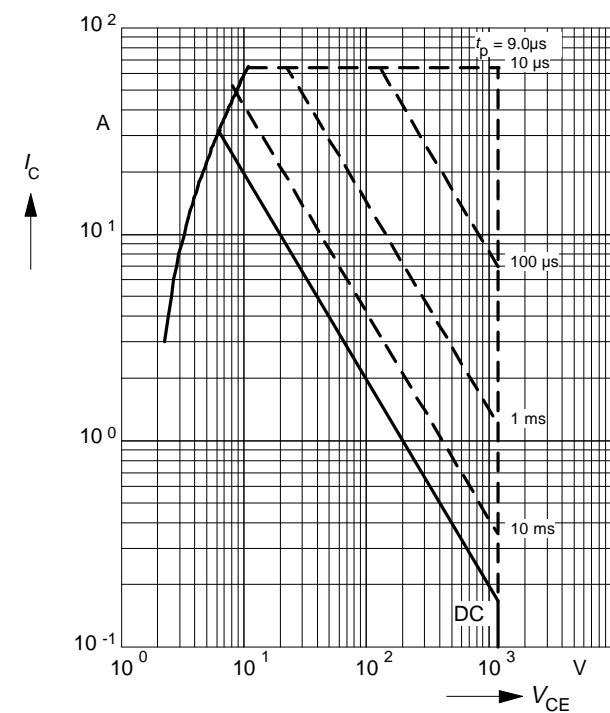

Transient thermal impedance IGBT

$$Z_{\text{thJC}} = f(t_p)$$

parameter: $D = t_p / T$

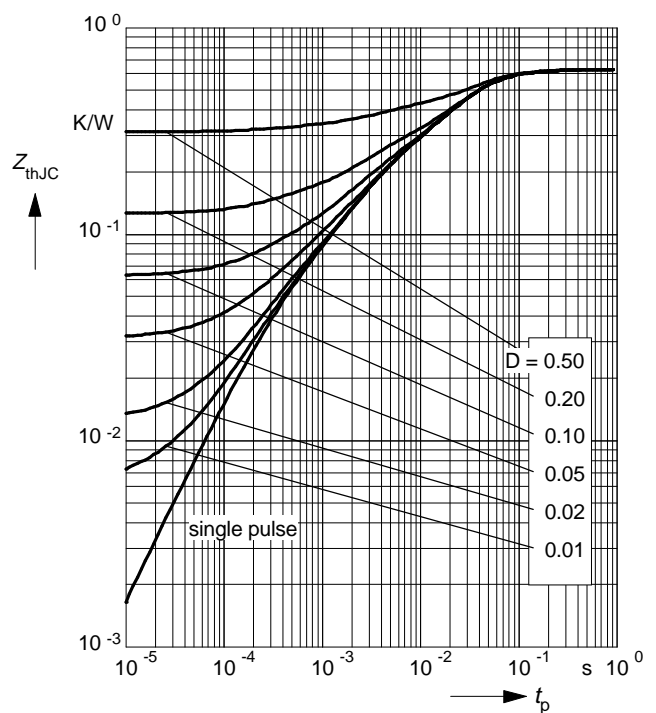

Typ. output characteristics

$$I_C = f(V_{CE})$$

parameter: $t_p = 80 \mu s, T_j = 25 \text{ }^\circ\text{C}$

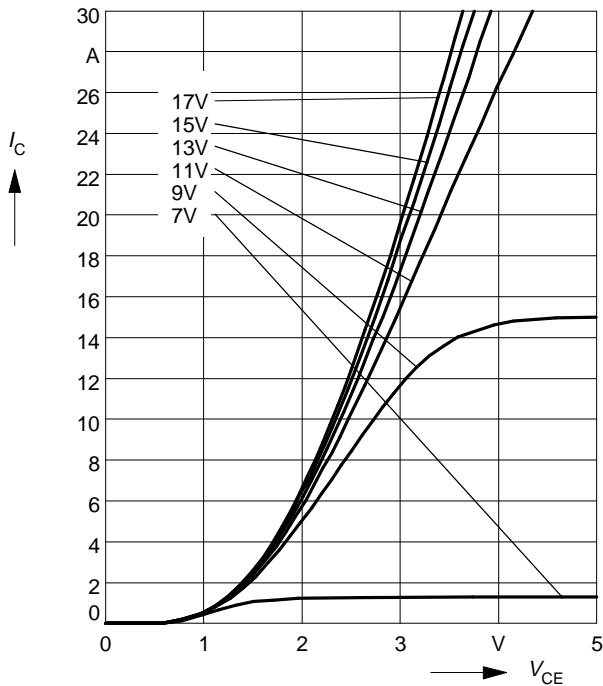

Typ. output characteristics

$$I_C = f(V_{CE})$$

parameter: $t_p = 80 \mu s, T_j = 125 \text{ }^\circ\text{C}$

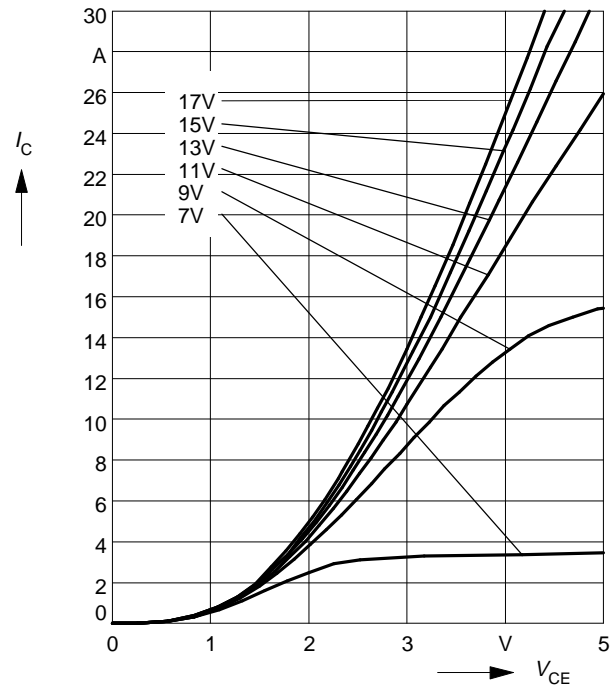

Typ. transfer characteristics

$$I_C = f(V_{GE})$$

parameter: $t_p = 80 \mu s, V_{CE} = 20 \text{ V}$

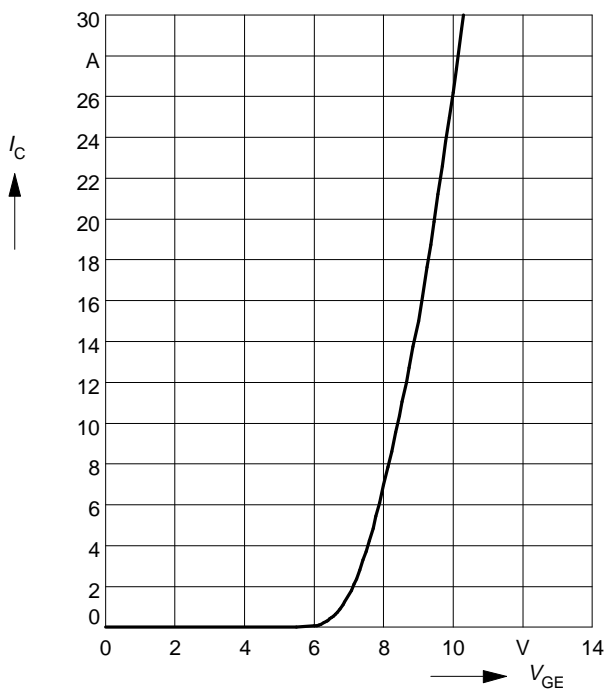

Typ. switching time

$t = f(I_C)$, inductive load, $T_j = 125^\circ\text{C}$
 par.: $V_{CE} = 600\text{ V}$, $V_{GE} = \pm 15\text{ V}$, $R_G = 82\ \Omega$

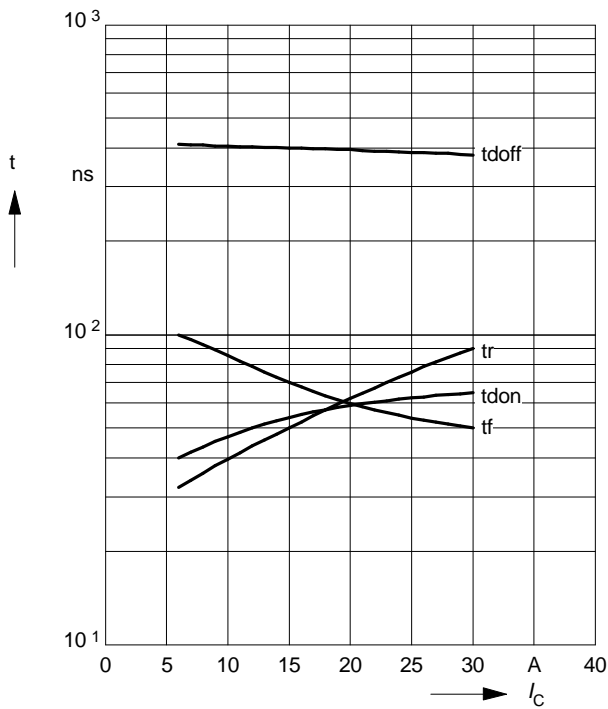

Typ. switching time

$t = f(R_G)$, inductive load, $T_j = 125^\circ\text{C}$
 par.: $V_{CE} = 600\text{ V}$, $V_{GE} = \pm 15\text{ V}$, $I_C = 15\text{ A}$

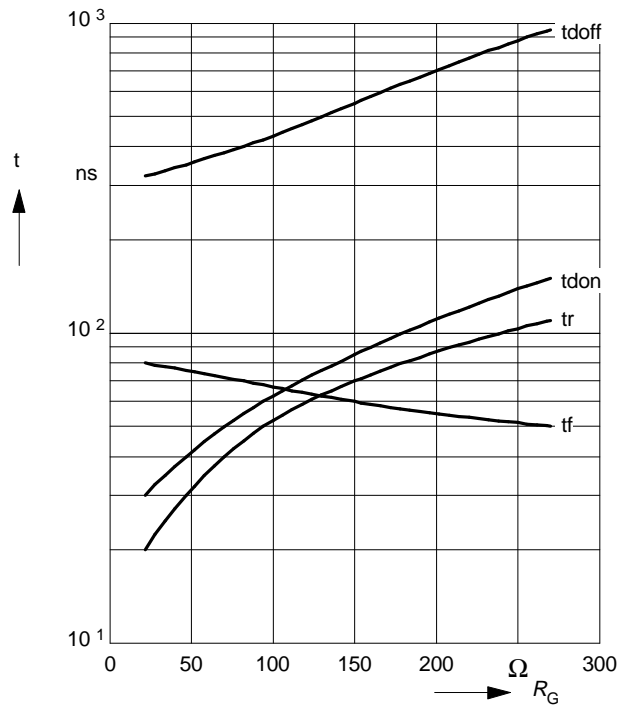

Typ. switching losses

$E = f(I_C)$, inductive load, $T_j = 125^\circ\text{C}$
 par.: $V_{CE} = 600\text{ V}$, $V_{GE} = \pm 15\text{ V}$, $R_G = 82\ \Omega$

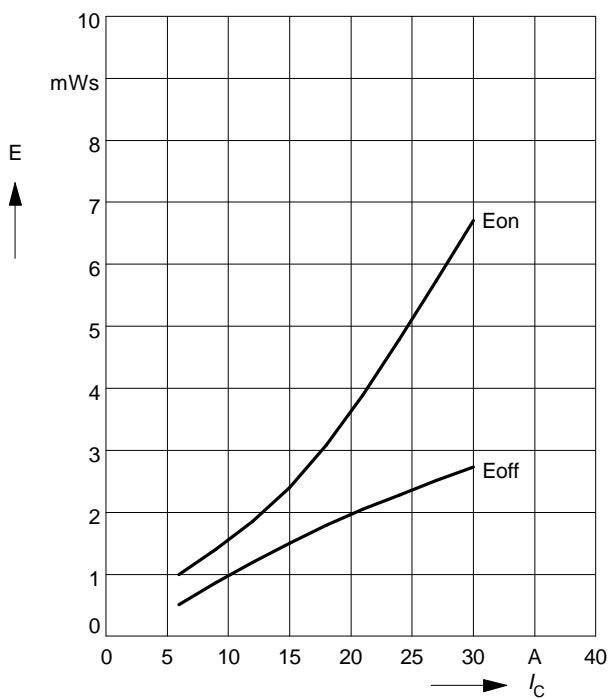

Typ. switching losses

$E = f(R_G)$, inductive load, $T_j = 125^\circ\text{C}$
 par.: $V_{CE} = 600\text{ V}$, $V_{GE} = \pm 15\text{ V}$, $I_C = 15\text{ A}$

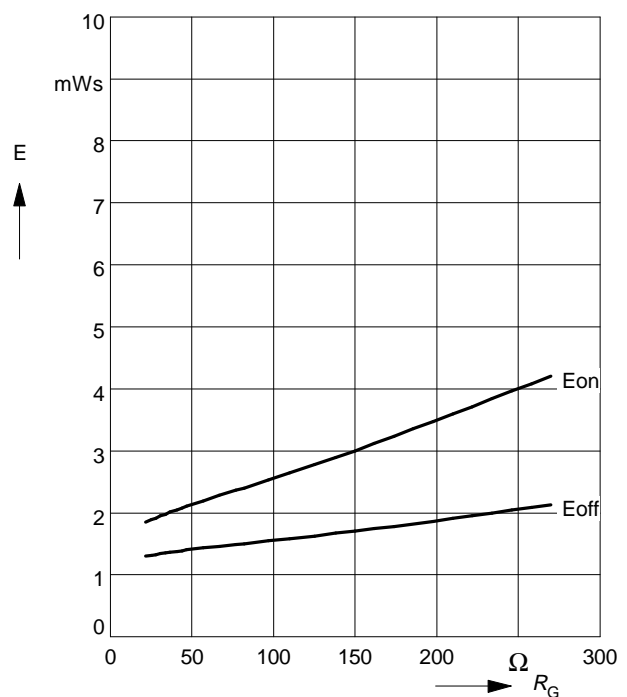

Typ. gate charge

$$V_{GE} = f(Q_{Gate})$$

parameter: $I_{C\ puls} = 15\ A$

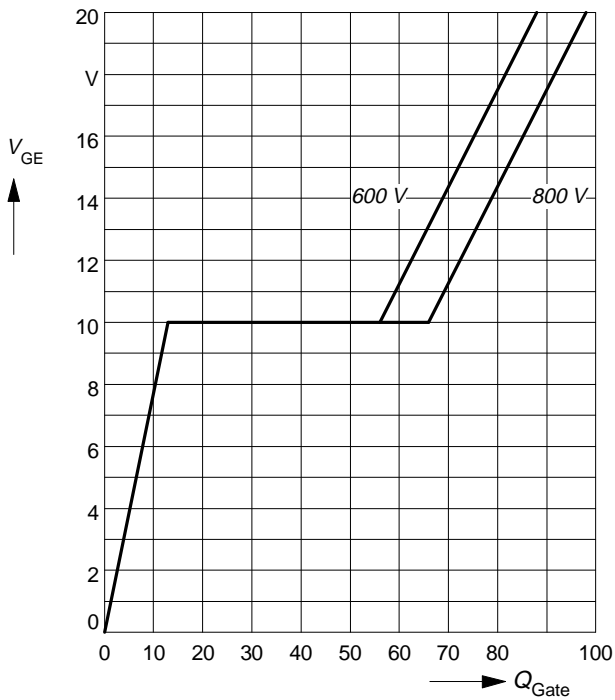

Typ. capacitances

$$C = f(V_{CE})$$

parameter: $V_{GE} = 0\ V, f = 1\ MHz$

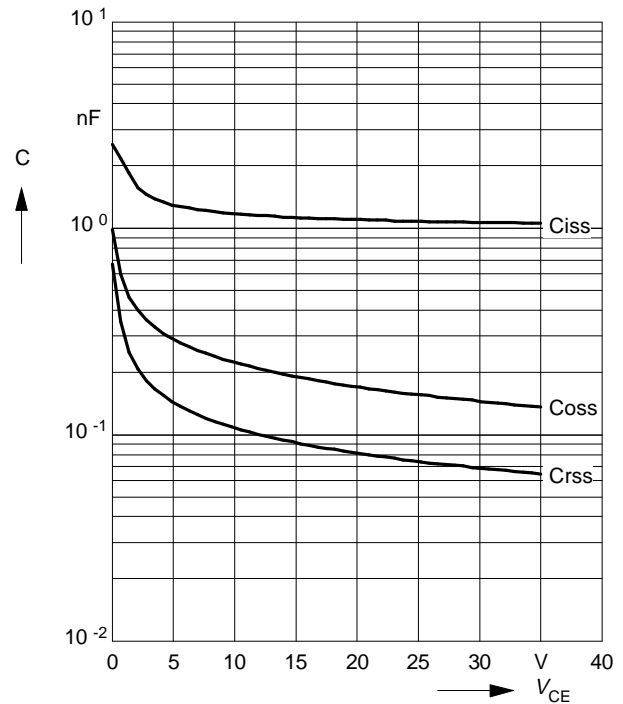

Short circuit safe operating area

$$I_{Csc} = f(V_{CE}), T_j = 150^\circ C$$

parameter: $V_{GE} = \pm 15\ V, t_{sc} \le 10\ \mu s, L < 25\ nH$

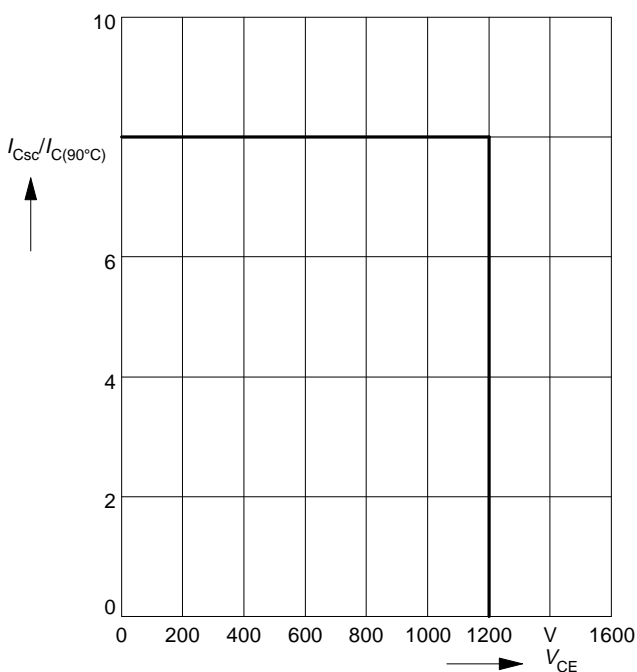

Reverse biased safe operating area

$$I_{Cpuls} = f(V_{CE}), T_j = 150^\circ C$$

parameter: $V_{GE} = 15\ V$

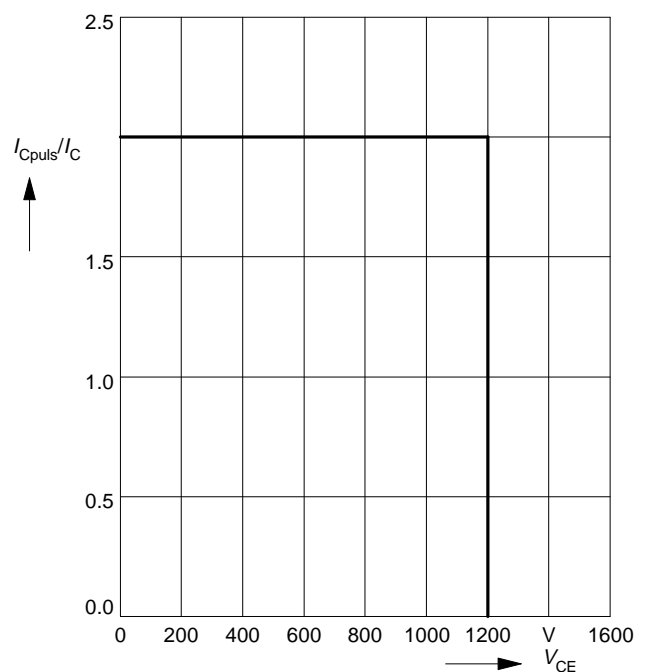

Package Outlines

Dimensions in mm

Weight:

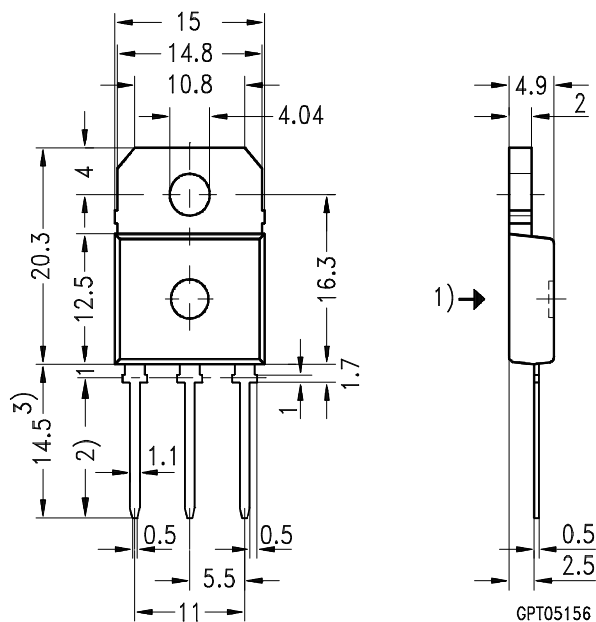

- 1) punch direction, burr max. 0.04
- 2) dip tinning
- 3) max. 15.5 by dip tinning press burr max. 0.05