

**Technical Data Sheet****Infrared Remote-control Receiver Module****IRM-H2xx/TR2 SERIES****Features**

- High shielding against electric field disturbance.
- Low voltage and low power consumption.
- Very small sizes.
- External dimensions 5.10(L)\*4.60(W)\*1.45(H)mm.
- High immunity against ambient light.
- Photodiode with integrated circuit.
- TTL and CMOS compatibility.
- High sensitivity.
- Top-received SMD.
- Suitable burst length  $\geq 10$  pulses/burst.
- RoHS refer to IRM-Vxxx,Hxxx series SGS report
- Pb free.
- The product itself will remain within RoHS compliant version.

**Descriptions**

The device is a miniature SMD type infrared remote control system receiver that has been developed and designed by utilizing the most updated IC technology. The PIN diode and preamplifier are assembled on PCB, the epoxy package is designed as an IR filter. The demodulated output signal can directly be decoded by a microprocessor.

**Applications**

1. Optical switch
2. Light detecting portion of remote control
  - AV instruments such as Audio, TV, VCR, CD, MD, etc.
  - Home appliances such as Air-conditioner, Fan , etc.
  - The other equipments with wireless remote control.
  - CATV set top boxes
  - Multi-media Equipment

**Device Selection Guide**

PART	MATERIAL	COLOR
Chip	Silicon	---
Package	Epoxy	Black
Metal case	SPCC	Silver white

**IRM-H2xx/TR2 SERIES**

**Package Dimensions**

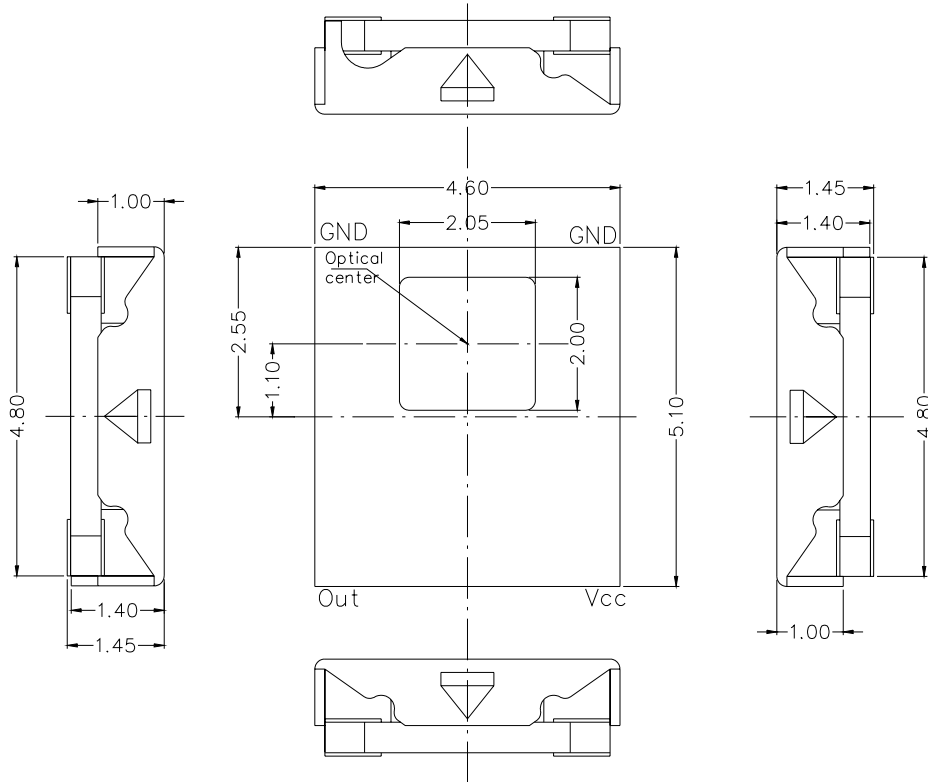

- Notes :**
- 1.All dimensions are in millimeters.
  - 2.Tolerances unless dimensions  $\pm 0.2\text{mm}$ .

**Soldering patterns**

The following soldering patterns are recommended for reflow-soldering :

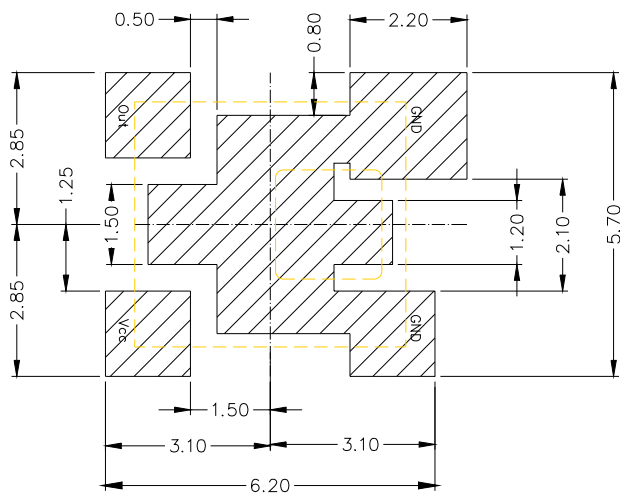

**View Back**

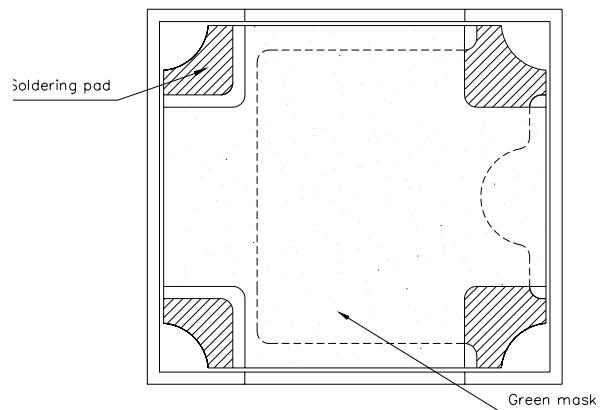

**IRM-H2xx/TR2 SERIES**
**Available Types For Different Carrier Frequencies**

Type	Carrier Frequencies (Typ)
IRM-H236/TR2	36 kHz
IRM-H238/TR2	38 kHz
IRM-H240/TR2	40 kHz

**Absolute Maximum Ratings (Ta=25°C)**

Parameter	Symbol	Rating	Unit	Notice
Supply Voltage	Vcc	6	V	
Operating Temperature	Topr	-25 ~ +85	°C	
Storage Temperature	Tstg	-25 ~ +85	°C	

**Recommended Operating Condition**

**Supply Voltage Rating: Vcc 2.7V to 5.5V**

**Electro-Optical Characteristics (Ta=25°C , Vcc = 3V)**

Parameter	Symbol	MIN.	TYP.	MAX.	Unit	Condition
Supply Current	Icc	---	---	3	mA	No signal input
Peak Wavelength	$\lambda_p$	---	940	---	nm	---
Reception Distance	L <sub>0</sub>	8	---	---	m	---
	L <sub>45</sub>	5	---	---		
Half Angle(Horizontal)	$\Theta_h$	---	45	---	deg	At the ray axis *1
Half Angle(Vertical)	$\Theta_v$	---	45	---	deg	
High Level Pulse Width	T <sub>H</sub>	400	---	800	$\mu s$	At the ray axis *2
Low Level Pulse Width	T <sub>L</sub>	400	---	800	$\mu s$	
High Level Output Voltage	V <sub>H</sub>	2.7	---	---	V	
Low Level Output Voltage	V <sub>L</sub>	---	0.2	0.5	V	

**Notes:**

\*1 : The ray receiving surface at a vertex and relation to the ray axis in the range of  $\theta= 0^\circ$  and  $\theta=45^\circ$ .

\*2 : A range from 30cm to the arrival distance. Average value of 50 pulses.

**IRM-H2xx/TR2 SERIES**

**The Notice of Application:**

Transmission remote control signal consist of four parts: Encode Part, IR Transmitter Source, IRM device, Decode Part

1. When IRM-H2xx code select frequency, it need to well understand the center system of encode part.
2. Strong or weak light of IR Transmitter can affect distance of transmission.
3. Minimum Burst Length  $T_{burst}$  (number of pulses per burst) : 10 cycles
4. It needs to ensure the translation range of decode part if it is applied to the pulse-width range.

If the above items hardly assure of its application, it'll cause NG(no good) message from the edge of signal.

**Test Method :**

The specified electro-optical characteristics is satisfied under the following Conditions at the controllable distance.

①Measurement place

A place that is nothing of extreme light reflected in the room.

②External light

Project the light of ordinary white fluorescent lamps which are not high Frequency lamps and must be less then 10 Lux at the module surface.  
( $E_e \leq 10\text{Lux}$ )

③Standard transmitter

A transmitter whose output is so adjusted as to  **$V_o=400\text{mVp-p}$**  and the output Wave form shown in Fig.-1.According to the measurement method shown in Fig.-2 the standard transmitter is specified.

However , the infrared photodiode to be used for the transmitter should be  $\lambda_p=940\text{nm}, \Delta\lambda=50\text{nm}$ . Also, photodiode is used of PD438B( $V_r=5\text{V}$ ).  
(Standard light / Light source temperature 2856°K).

④Measuring system

According to the measuring system shown in Fig.-3

Fig.-1 Transmitter Wave Form

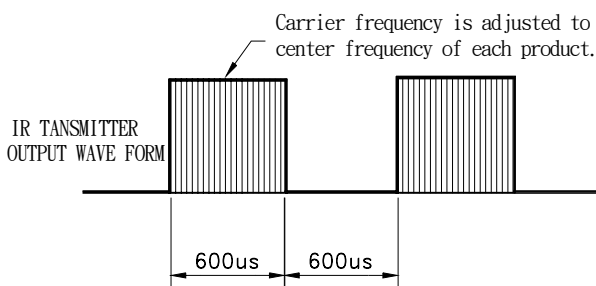

D.U.T output Pulse

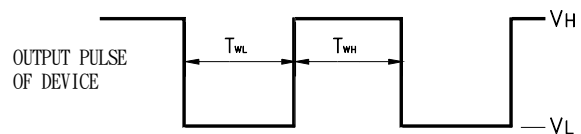

Duty=0.5

**IRM-H2xx/TR2 SERIES**

Fig.-2 Measuring Method

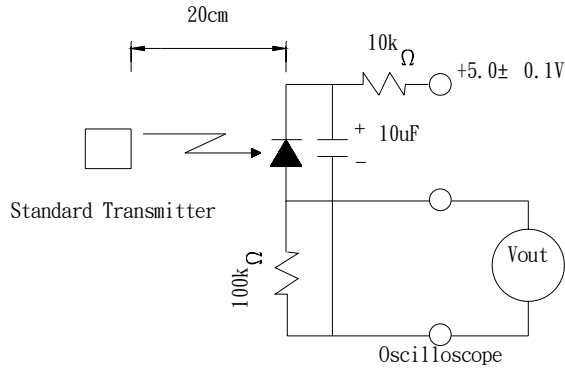
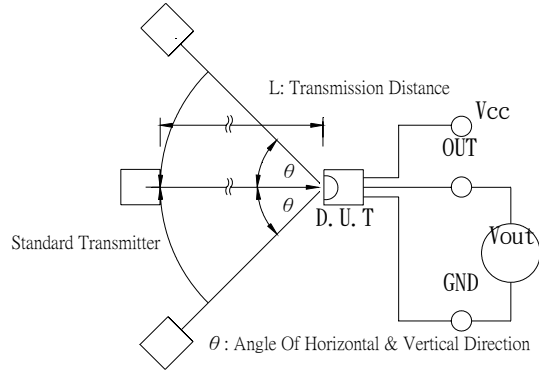
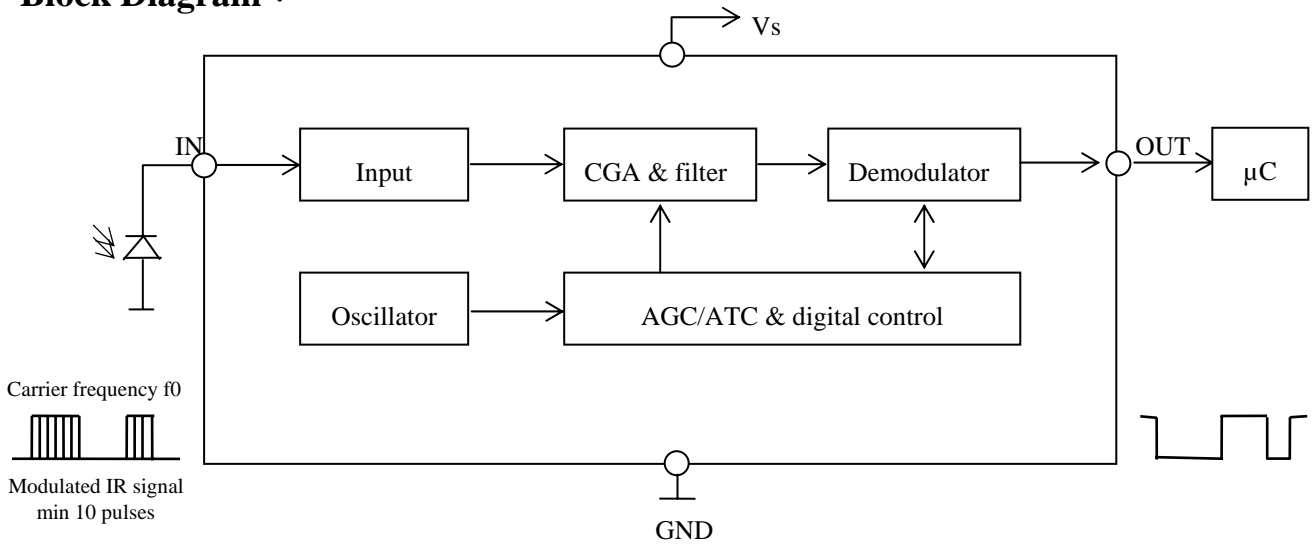

Fig.-3 Measuring System



**Block Diagram :**



**Application Circuit :**

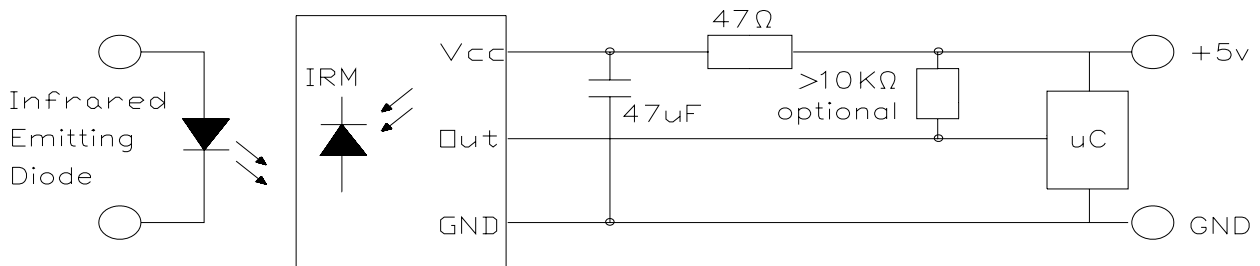

**RC Filter should be connected closely between Vcc pin and GND pin**

**IRM-H238/TR2 SERIES**

**Typical Electro-Optical Characteristics Curves**

Fig.-4 Relative Spectral Sensitivity vs. Wavelength

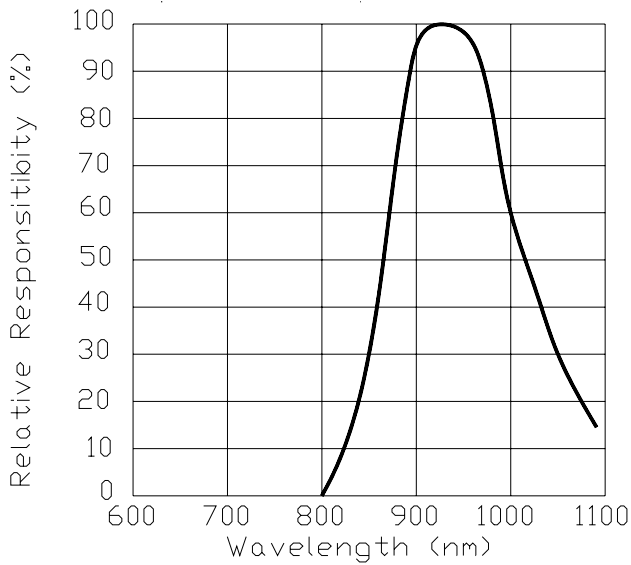

Fig.-5 Relative Transmission Distance vs. Direction

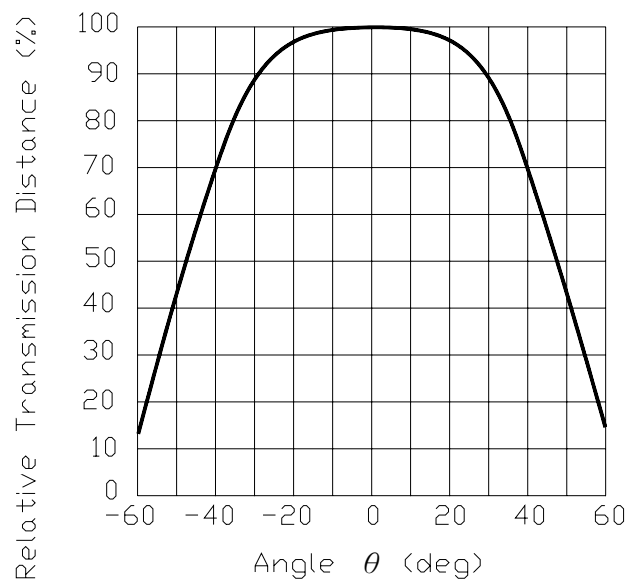

Fig.-6 Output Pulse Length vs. Arrival Distance

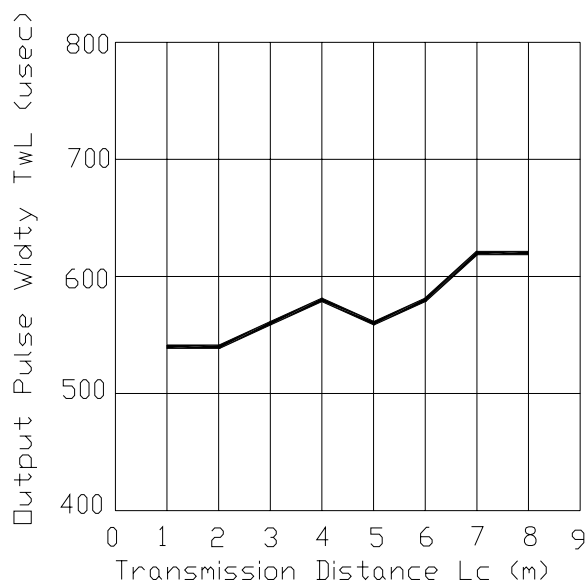
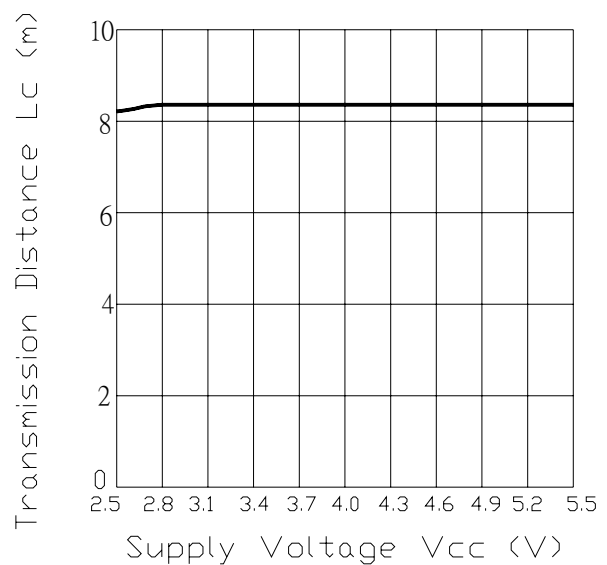

Fig.-7 Arrival Distance vs. Supply Voltage



**IRM-H2xx/TR2 SERIES**

**Typical Electro-Optical Characteristics Curves**

Fig.-8 Arrival Distance vs. Ambient Temperature Fig.-9 Relative Transmission Distance vs. Center Carrier Frequency

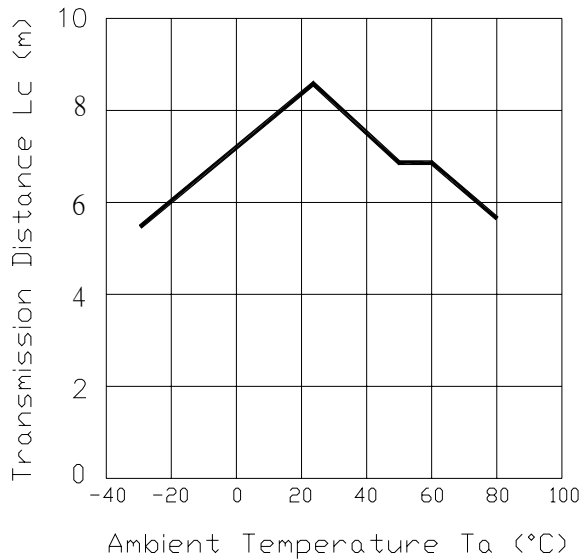

**IRM-H236/TR2**

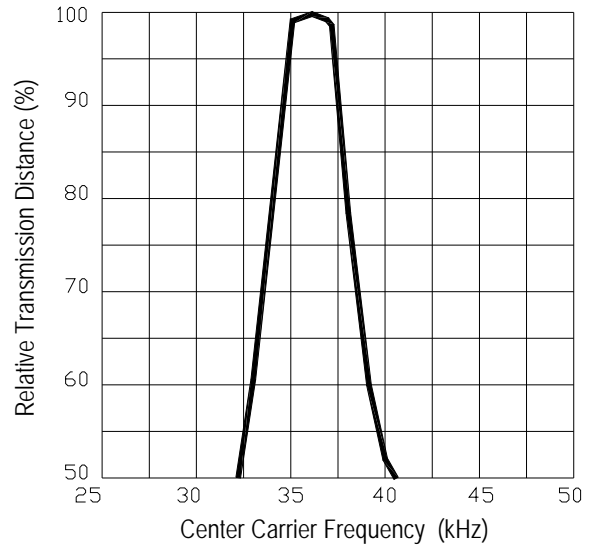
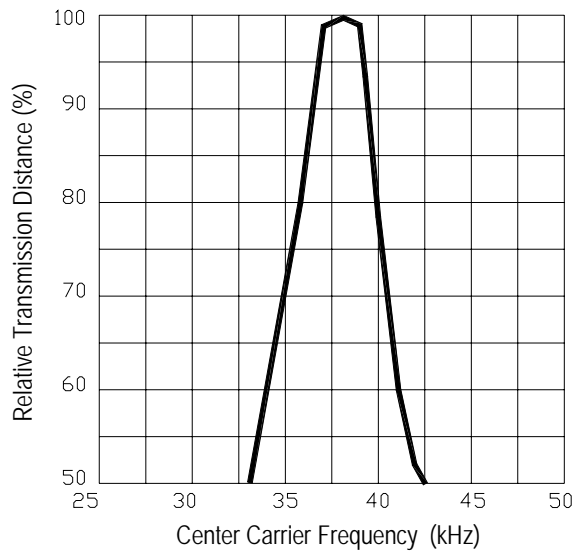
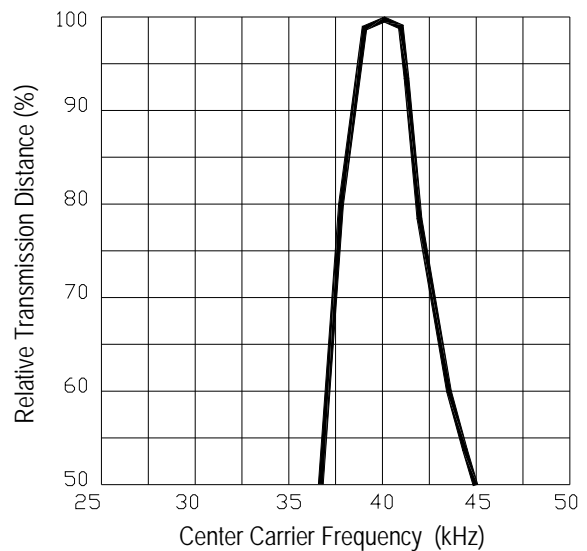

Fig.-9 Relative Transmission Distance vs. Center Carrier Frequency

**IRM-H238/TR2**



**IRM-H240/TR2**



**IRM-H2xx/TR2 SERIES**

**Reliability Test Item And Condition**

The reliability of products shall be satisfied with items listed below.

Confidence level : 90%

LTPD : 10%

Reflow Terms: JEDEC Level 4 Specification

Drying; Temp.:125°C 24hrs → Moisture 30°C / 60% RH 96hrs → Reflow Temp.: 260°C±5°C

10sec, 3 times

Note:

1. Not sooner than 15 minutes and not longer than 4 hours after removal from the temperature/humidity chamber.
2. The time between reflow shall be 5 minutes minimum and 60 minutes maximum.

Test Items	Test Conditions	Failure Judgement Criteria	Samples(n) Defective(c)
Temperature cycle	1 cycle : -25°C ↔ +85°C (30min)(5min)(30min) 300 cycle test	$L_0 \leq L \times 0.8$ $L_{45} \leq L \times 0.8$	n=76,c=0
High temperature test	Temp : +85°C Vcc : 5V 1000hrs	L: Lower specification limit	n=76,c=0
Low temperature storage	Temp : -40°C 1000hrs	*Icc : Operate Current (mA)	n=76,c=0
High temperature High humidity	Ta : 85°C , RH : 85% 1000hrs	Variation $\leq \pm 20\%$ :	n=76,c=0



**Recommended method of storage**

Dry box storage is recommended as soon as the aluminum bag has been opened prevent moisture absorption. The following conditions should be observed, if dry boxes are not available:

- Storage temperature 10°C to 30°C
- Storage humidity  $\leq 60\%RH$  max.

After more than 72 hours under these conditions moisture content will be too high for Reflow soldering:

In case of moisture absorption, the devices will recover to former condition by drying under the following condition:

- 192 hours at 40°C+5°C/-0°C and 5%RH (dry air / nitrogen) or
- 96 hours at 60°C+5°C and < 5%RH for all device containers or
- 24 hours at 125°C+5°C not suitable for reel or tubes.

**ESD Precaution**

Proper storage and handing procedures should be followed to prevent ESD damage to the devices especially when they are removed from the Anti-static bag. Electro-Static Sensitive Devices warning labels are on the packing.

**Recommended Solder Profile**

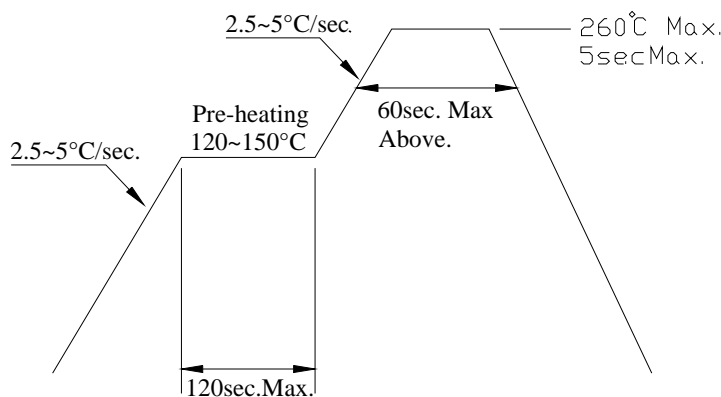

**Notice:**

- (1) Reflow soldering should not be done more than two times.
- (2) When soldering, do not put stress on the IRM-H2xx Series devices during heating.
- (3) After soldering, do not warp the circuit board.

**IRM-H2xx/TR2 SERIES**

**Carrier Tape Dimensions: Loaded quantity 2000 PCS per reel**

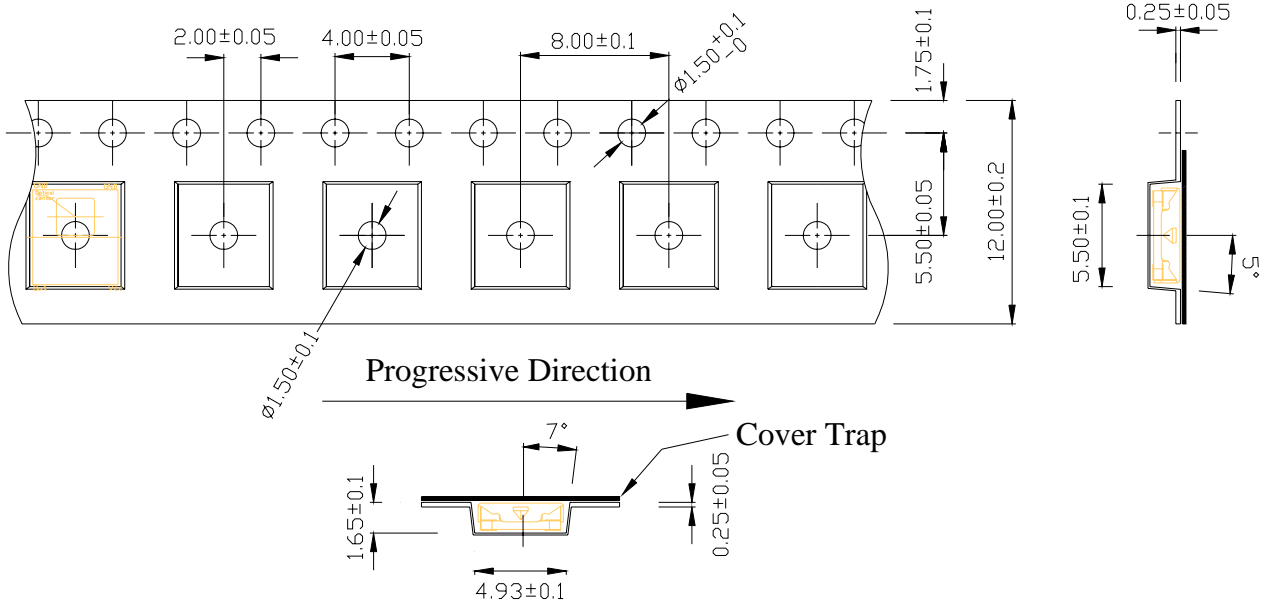

**Packing process**

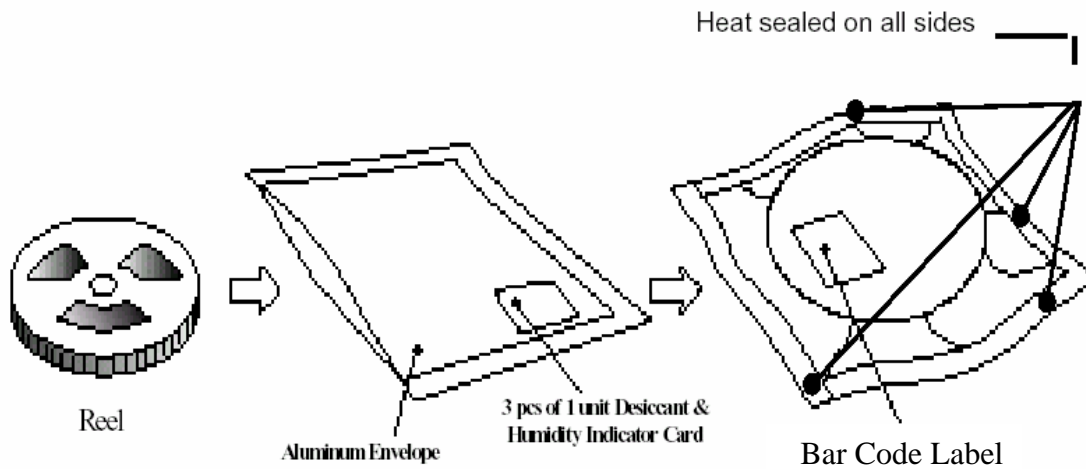

**IRM-H2xx/TR2 SERIES****Packing Quantity Specification**

1. 2000 PCS/1 Reel
2. 5 Reel /1Carton

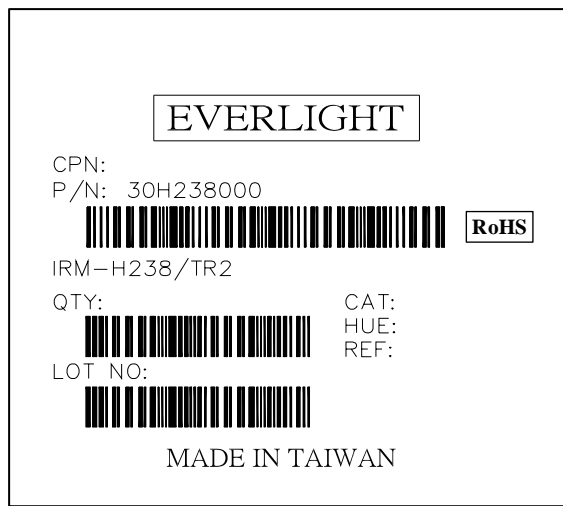
**Label Form Specification**

CPN: Customer's Production Number  
P/N : Production Number  
QTY: Packing Quantity  
CAT: None  
HUE: None  
REF: Reference  
LOT No: Lot Number  
MADE IN TAIWAN: Production Place

**Notes**

1. Above specification may be changed without notice. EVERLIGHT will reserve authority on material change for above specification.
2. When using this product, please observe the absolute maximum ratings and the instructions for using outlined in these specification sheets. EVERLIGHT assumes no responsibility for any damage resulting from use of the product which does not comply with the absolute maximum ratings and the instructions included in these specification sheets.
3. These specification sheets include materials protected under copyright of EVERLIGHT corporation. Please don't reproduce or cause anyone to reproduce them without EVERLIGHT's consent.

**EVERLIGHT ELECTRONICS CO., LTD.**

Office: No 25, Lane 76, Sec 3, Chung Yang Rd,  
Tucheng, Taipei 236, Taiwan, R.O.C

Tel: 886-2-2267-2000, 2267-9936

Fax: 886-2267-6244, 2267-6189, 2267-6306

<http://www.everlight.com>