



EVERLIGHT ELECTRONICS CO., LTD.

DEVICE NUMBER : DPT-020-054 REV : 1.2
ECN : _____ PAGE : 1/7

3mm Phototransistor,T-1

MODEL NO : PT204-6B

■ Features :

- Fast response time
- High photo sensitivity

■ Description :

- PT204-6B is a high speed and high sensitive NPN silicon phototransistor molded in a standard $\phi 3$ mm package . The package is an IR filter, spectrally match to IR emitter.

■ Applications :

- Optoelectronic switch
- VCRs ,Video camera
- Floppy disk drive
- Infrared applied system

PART NO.	CHIP	LENS COLOR
	MATERIAL	
PT	Silicon	Black



3mm Phototransistor,T-1

MODEL NO : PT204-6B

■ Package Dimensions :

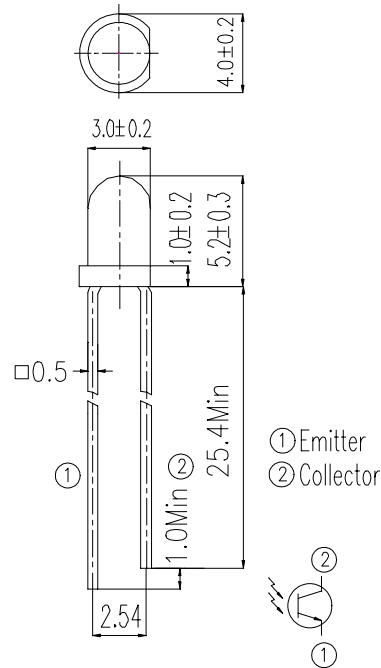

■ Notes :

1. All dimensions are in millimeter.
2. Protruded resin under flange 1.5 mm Max.
3. Lead spacing is measured where the lead emerge from the package.
4. Lens color : Black.
5. Above specification may be changed without notice. EVERLIGHT will reserve authority on material change for above specification.
6. These specification sheets include materials protected under copyright of EVERLIGHT corporation . Please don't reproduce or cause anyone to reproduce them without EVERLIGHT's consent.
7. When using this product , please observe the absolute maximum ratings and the instructions for use outlined in these specification sheets. EVERLIGHT assumes no responsibility for any damage resulting from use of the product which does not comply with the absolute maximum ratings and the instructions included in these specification sheets.



3mm Phototransistor,T-1

MODEL NO : PT204-6B

■ Absolute Maximum Ratings at Ta = 25°C

Parameter	Symbol	Rating	Unit	Notice
Collector-Emitter Voltage	V_{CEO}	30	V	
Emitter-Collector- Voltage	V_{ECO}	5	V	
Collector Current	I_C	20	mA	
Operating Temperature	Topr	-25 ~ +85	°C	
Storage Temperature	Tstg	-40 ~ +85	°C	
Soldering Temperature	Tsol	260	°C	4mm from mold body less than 5 seconds
Power Dissipation at(or below) 25°C Free Air Temperature	Pc	75	mW	

■ Electronic Optical Characteristics :

Parameter	Symbol	Min.	Typ.	Max.	Unit	Condition
Collector-Emitter Breakdown Voltage	BV_{CEO}	30	----	----	V	$I_C=100 \mu A$ $E_e=0mW/cm^2$
Emitter-Collector Breakdown Voltage	BV_{ECO}	5	----	----	V	$I_E=100 \mu A$ $E_e=0mW/cm^2$
Collector-Emitter Saturation Voltage	$V_{CE(sat)}$	----	----	0.4	V	$I_C=2mA$ $E_e=1mW/cm^2$
Rise Time	t_r	----	15	----	μS	$V_{CE}=5V$ $I_C=1mA$ $R_L=1000 \Omega$
Fall Time	t_f	----	15	----		
Collector Dark Current	I_{CEO}	----	----	100	nA	$V_{CE}=20V$ $E_e=0mW/cm^2$
On State Collector Current	$I_{C(on)}$	0.7	2.0	----	mA	$V_{CE}=5V$ $E_e=1mW/cm^2$
Wavelength of Peak Sensitivity	λ_p	----	980	----	nm	----
Rang of Spectral Bandwidth	$\lambda_{0.5}$	----	840--- 1200	----	nm	----



3mm Phototransistor, T-1

MODEL NO : PT204-6B

■ Typical Electrical/Optical/Characteristics Curves

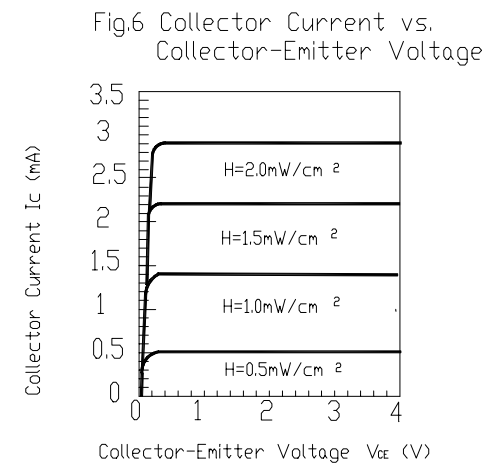
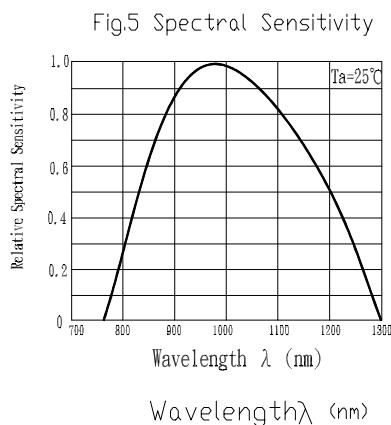
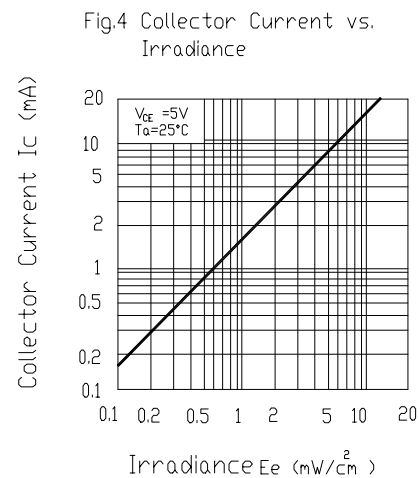
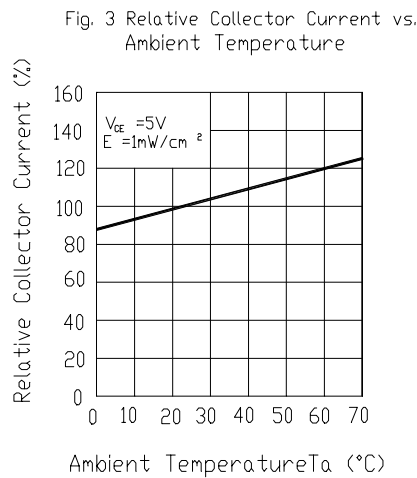
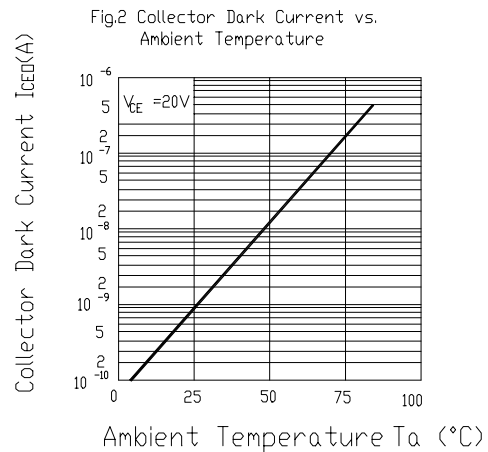
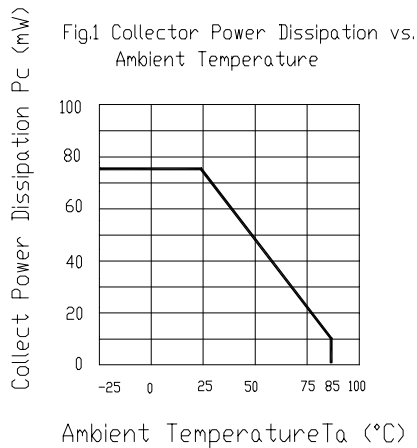



3mm Phototransistor,T-1

MODEL NO : PT204-6B

Reliability Test Item And Condition

The reliability of products shall be satisfied with items listed below.

Confidence level:90%

LTPD:10%

NO.	Item	Test Conditions	Test Hours/ Cycles	Sample Size	Failure Judgement Criteria	Ac/Re
1	Solder Heat	TEMP : 260°C± 5°C	5 secs	22 pcs	$I_{c(on)} \leq L \times 0.8$ L :Lower specification limit	0/1
2	Temperature Cycle	H : +85°C 30 mins ↑ 5 mins ↓ L : -55°C 30 mins	50 cycles	22 pcs		0/1
3	Thermal Shock	H : +100°C 5 mins ↑ 10 secs ↓ L : -10°C 5 mins	50 cycles	22 pcs		0/1
4	High Temperature Storage	TEMP. : +100°C	1000 hrs	22 pcs		0/1
5	Low Temperature Storage	TEMP. : -55°C	1000 hrs	22 pcs		0/1
6	DC Operating Life	$V_{CE}=5V$	1000 hrs	22 pcs		0/1
7	High Temperature / High Humidity	85°C / 85% R.H.	1000 hrs	22 pcs		0/1

3mm Phototransistor, T-1

MODEL NO : PT204-6B

■ Test Method For On State Collector Current :

Condition : $E_e=1\text{mW/cm}^2$, $V_{CE}=5\text{V}$

Test Item : Collector Current [$I_{C(on)}$]

Unit : mA

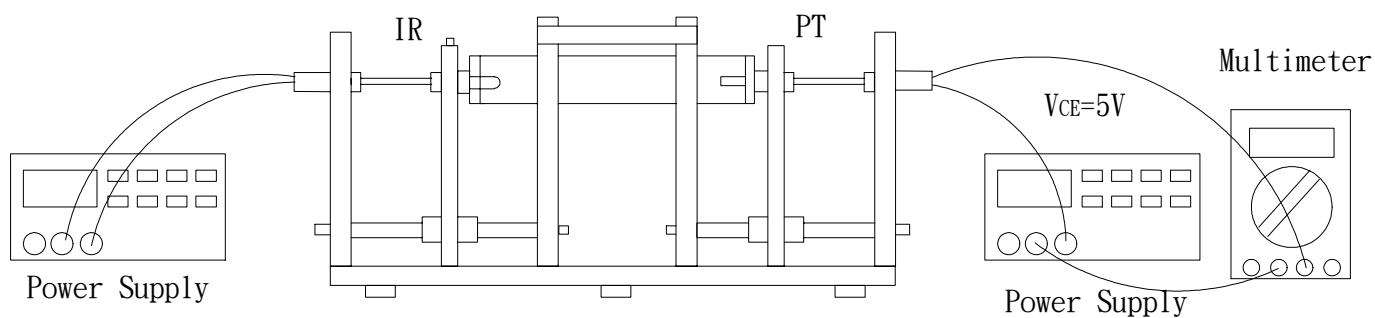

■ Rankings

Parameter	Symbol	Min	Max	Unit	Test Condition
G	$I_{C(ON)}$	0.70	1.90	mA	$E_e=1\text{mW/cm}^2$ $V_{CE}=5\text{V}$
H		1.14	2.60		
J		1.77	3.61		
k		2.68	5.07		



3mm Phototransistor,T-1

MODEL NO : PT204-6B

■ Packing Specifications

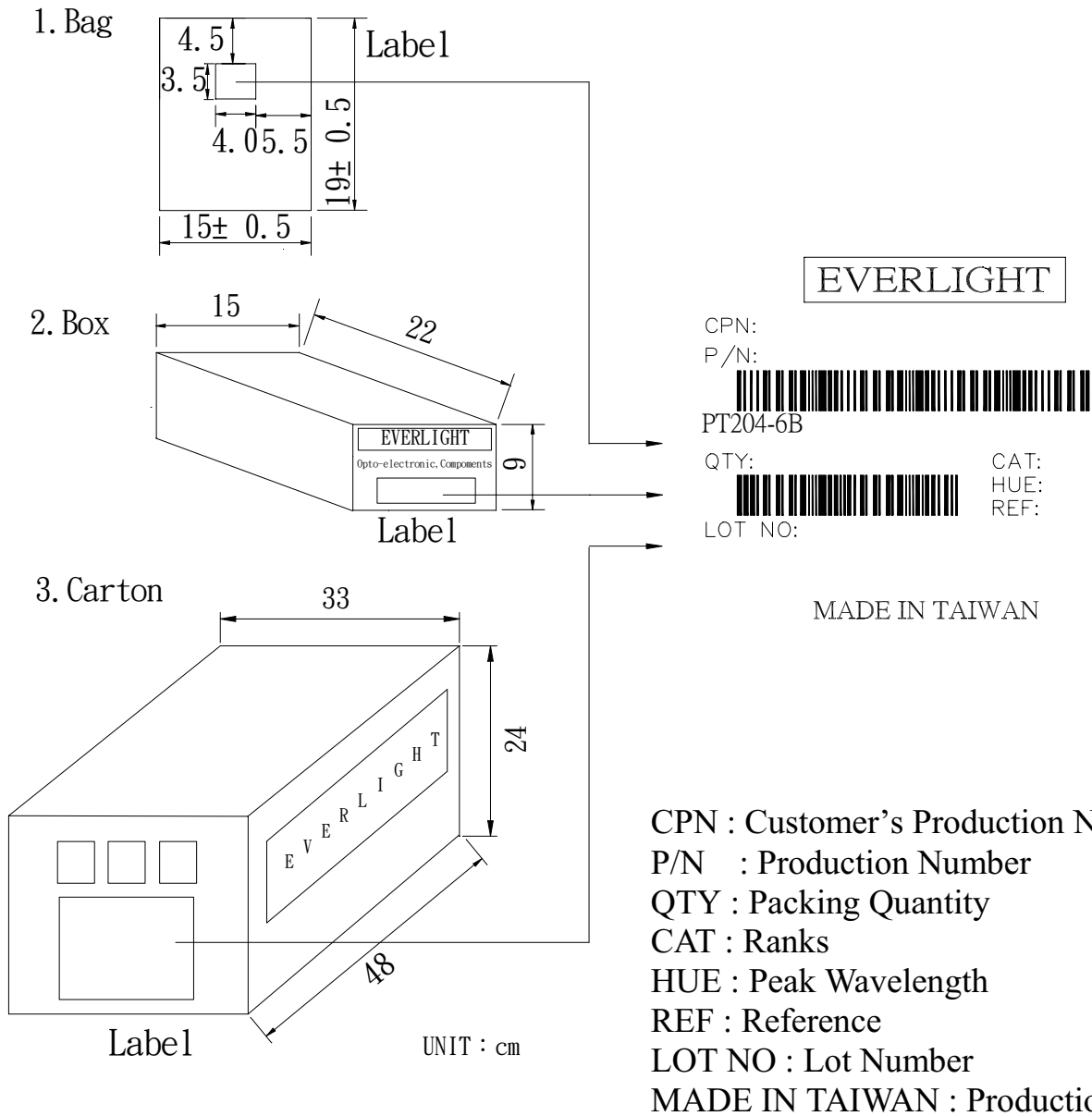

■ Packing Quantity Specification

1. 1000 Pcs/1Bag , 6 Bags/1Box
2. 10 Boxes/1Carton