



## VNP10N07

# "OMNIFET": FULLY AUTOPROTECTED POWER MOSFET

| TYPE     | V <sub>clamp</sub> | R <sub>DS(on)</sub> | I <sub>lim</sub> |
|----------|--------------------|---------------------|------------------|
| VNP10N07 | 70 V               | 0.1 Ω               | 10 A             |

- LINEAR CURRENT LIMITATION
- THERMAL SHUT DOWN
- SHORT CIRCUIT PROTECTION
- INTEGRATED CLAMP
- LOW CURRENT DRAWN FROM INPUT PIN
- DIAGNOSTIC FEEDBACK THROUGH INPUT PIN
- ESD PROTECTION
- DIRECT ACCESS TO THE GATE OF THE POWER MOSFET (ANALOG DRIVING)
- COMPATIBLE WITH STANDARD POWER MOSFET
- STANDARD TO-220 PACKAGE

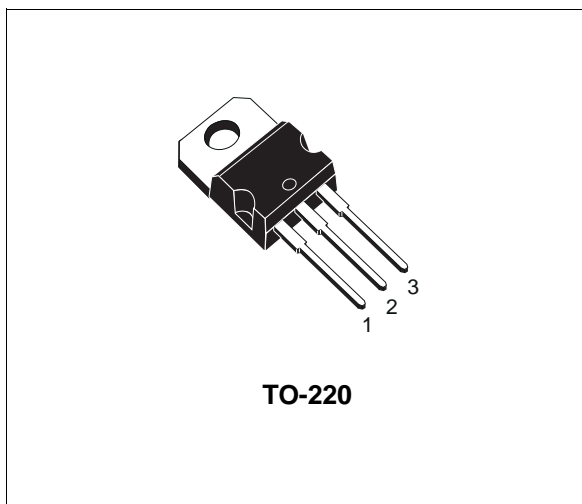

### DESCRIPTION

The VNP10N07 is a monolithic device made using STMicroelectronics VIPower Technology, intended for replacement of standard power MOSFETS in DC to 50 KHz applications. Built-in thermal shut-down, linear current limi-

tation and overvoltage clamp protect the chip in harsh environments.

Fault feedback can be detected by monitoring the voltage at the input pin.

### BLOCK DIAGRAM

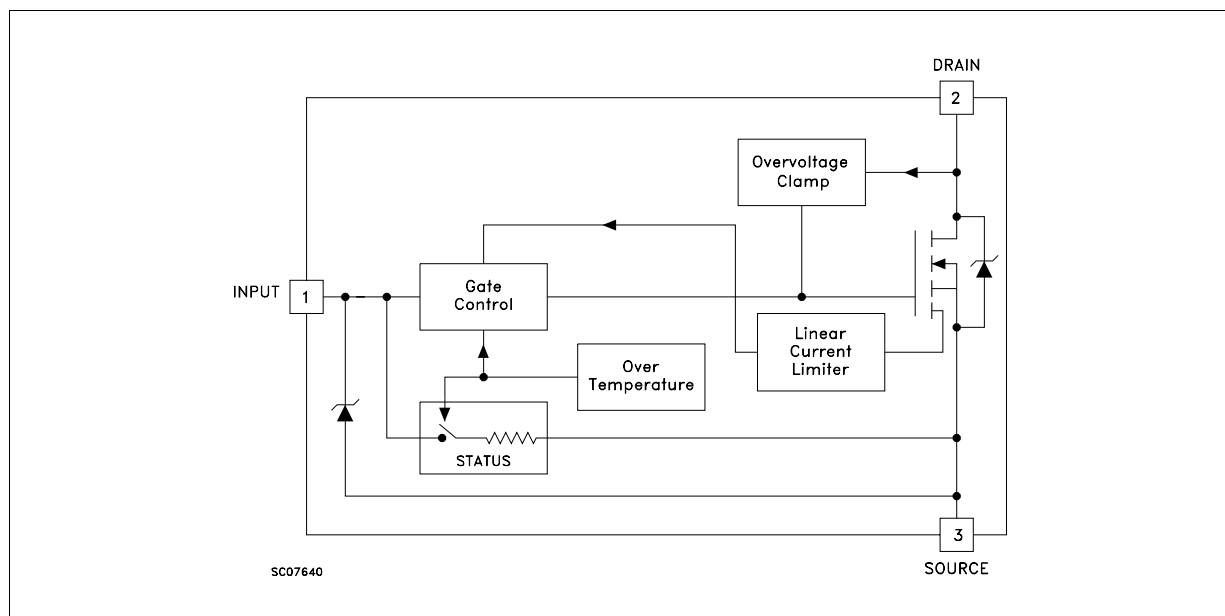

## VNP10N07

### ABSOLUTE MAXIMUM RATING

| Symbol    | Parameter  | Value              | Unit |
|-----------|--|--------------------|------|
| $V_{DS}$  | Drain-source Voltage ( $V_{in} = 0$ )                          | Internally Clamped | V    |
| $V_{in}$  | Input Voltage  | 18                 | V    |
| $I_D$     | Drain Current  | Internally Limited | A    |
| $I_R$     | Reverse DC Output Current                                      | -14                | A    |
| $V_{esd}$ | Electrostatic Discharge ( $C = 100$ pF, $R = 1.5$ K $\Omega$ ) | 2000               | V    |
| $P_{tot}$ | Total Dissipation at $T_c = 25$ °C                             | 50                 | W    |
| $T_j$     | Operating Junction Temperature                                 | Internally Limited | °C   |
| $T_c$     | Case Operating Temperature                                     | Internally Limited | °C   |
| $T_{stg}$ | Storage Temperature  | -55 to 150         | °C   |

### THERMAL DATA

|                |                                     |     |      |      |
|----------------|-------------------------------------|-----|------|------|
| $R_{thj-case}$ | Thermal Resistance Junction-case    | Max | 2.5  | °C/W |
| $R_{thj-amb}$  | Thermal Resistance Junction-ambient | Max | 62.5 | °C/W |

### ELECTRICAL CHARACTERISTICS ( $T_{case} = 25$ °C unless otherwise specified)

OFF

| Symbol      | Parameter   | Test Conditions  | Min. | Typ. | Max.      | Unit               |
|-------------|---|--|------|------|-----------|--------------------|
| $V_{CLAMP}$ | Drain-source Clamp Voltage                        | $I_D = 200$ mA $V_{in} = 0$                                  | 60   | 70   | 80        | V                  |
| $V_{CLTH}$  | Drain-source Clamp Threshold Voltage              | $I_D = 2$ mA $V_{in} = 0$                                    | 55   |      |           | V                  |
| $V_{INCL}$  | Input-Source Reverse Clamp Voltage                | $I_{in} = -1$ mA   | -1   |      | -0.3      | V                  |
| $I_{DSS}$   | Zero Input Voltage Drain Current ( $V_{in} = 0$ ) | $V_{DS} = 13$ V $V_{in} = 0$<br>$V_{DS} = 25$ V $V_{in} = 0$ |      |      | 50<br>200 | $\mu$ A<br>$\mu$ A |
| $I_{ISS}$   | Supply Current from Input Pin                     | $V_{DS} = 0$ V $V_{in} = 10$ V                               |      | 250  | 500       | $\mu$ A            |

ON (\*)

| Symbol       | Parameter                         | Test Conditions   | Min. | Typ. | Max.        | Unit                 |
|--------------|-----------------------------------|---|------|------|-------------|----------------------|
| $V_{IN(th)}$ | Input Threshold Voltage           | $V_{DS} = V_{in}$ $I_D + I_{in} = 1$ mA                   | 0.8  |      | 3           | V                    |
| $R_{DS(on)}$ | Static Drain-source On Resistance | $V_{in} = 10$ V $I_D = 5$ A<br>$V_{in} = 5$ V $I_D = 5$ A |      |      | 0.1<br>0.14 | $\Omega$<br>$\Omega$ |

DYNAMIC

| Symbol       | Parameter                | Test Conditions                          | Min. | Typ. | Max. | Unit |
|--------------|--------------------------|--|------|------|------|------|
| $g_{fs}$ (*) | Forward Transconductance | $V_{DS} = 13$ V $I_D = 5$ A              | 6    | 8    |      | S    |
| $C_{oss}$    | Output Capacitance       | $V_{DS} = 13$ V $f = 1$ MHz $V_{in} = 0$ |      | 350  | 500  | pF   |

## ELECTRICAL CHARACTERISTICS (continued)

## SWITCHING (\*\*)

| Symbol         | Parameter             | Test Conditions  | Min. | Typ. | Max. | Unit             |
|----------------|-----------------------|--|------|------|------|------------------|
| $t_{d(on)}$    | Turn-on Delay Time    | $V_{DD} = 15\text{ V}$ $I_d = 5\text{ A}$  |      | 50   | 100  | ns               |
| $t_r$          | Rise Time             | $V_{gen} = 10\text{ V}$ $R_{gen} = 10\ \Omega$   |      | 80   | 160  | ns               |
| $t_{d(off)}$   | Turn-off Delay Time   | (see figure 3)   |      | 230  | 400  | ns               |
| $t_f$          | Fall Time             |  |      | 100  | 180  | ns               |
| $t_{d(on)}$    | Turn-on Delay Time    | $V_{DD} = 15\text{ V}$ $I_d = 5\text{ A}$  |      | 600  | 900  | ns               |
| $t_r$          | Rise Time             | $V_{gen} = 10\text{ V}$ $R_{gen} = 1000\ \Omega$   |      | 0.9  | 2    | $\mu\text{s}$    |
| $t_{d(off)}$   | Turn-off Delay Time   | (see figure 3)   |      | 3.8  | 6    | $\mu\text{s}$    |
| $t_f$          | Fall Time             |  |      | 1.7  | 2.5  | $\mu\text{s}$    |
| $(di/dt)_{on}$ | Turn-on Current Slope | $V_{DD} = 15\text{ V}$ $I_D = 5\text{ A}$<br>$V_{in} = 10\text{ V}$ $R_{gen} = 10\ \Omega$ |      | 60   |      | A/ $\mu\text{s}$ |
| $Q_i$          | Total Input Charge    | $V_{DD} = 12\text{ V}$ $I_D = 5\text{ A}$ $V_{in} = 10\text{ V}$                           |      | 30   |      | nC               |

## SOURCE DRAIN DIODE

| Symbol         | Parameter                | Test Conditions   | Min. | Typ. | Max. | Unit          |
|----------------|--------------------------|---|------|------|------|---------------|
| $V_{SD} (*)$   | Forward On Voltage       | $I_{SD} = 5\text{ A}$ $V_{in} = 0$  |      |      | 1.6  | V             |
| $t_{rr} (**)$  | Reverse Recovery Time    | $I_{SD} = 5\text{ A}$ $di/dt = 100\text{ A}/\mu\text{s}$<br>$V_{DD} = 30\text{ V}$ $T_j = 25\text{ }^\circ\text{C}$ |      | 125  |      | ns            |
| $Q_{rr} (**)$  | Reverse Recovery Charge  | (see test circuit, figure 5)  |      | 0.3  |      | $\mu\text{C}$ |
| $I_{RRM} (**)$ | Reverse Recovery Current |   |      | 4.8  |      | A             |

## PROTECTION

| Symbol         | Parameter                     | Test Conditions  | Min.   | Typ.     | Max.     | Unit                           |
|----------------|-------------------------------|--|--------|----------|----------|--------------------------------|
| $I_{lim}$      | Drain Current Limit           | $V_{in} = 10\text{ V}$ $V_{DS} = 13\text{ V}$<br>$V_{in} = 5\text{ V}$ $V_{DS} = 13\text{ V}$  | 7<br>7 | 10<br>10 | 14<br>14 | A<br>A                         |
| $t_{dim} (**)$ | Step Response Current Limit   | $V_{in} = 10\text{ V}$<br>$V_{in} = 5\text{ V}$  |        | 20<br>50 | 30<br>80 | $\mu\text{s}$<br>$\mu\text{s}$ |
| $T_{jsh} (**)$ | Overtemperature Shutdown      |  | 150    |          |          | $^\circ\text{C}$               |
| $T_{jrs} (**)$ | Overtemperature Reset         |  | 135    |          |          | $^\circ\text{C}$               |
| $I_{gf} (**)$  | Fault Sink Current            | $V_{in} = 10\text{ V}$ $V_{DS} = 13\text{ V}$<br>$V_{in} = 5\text{ V}$ $V_{DS} = 13\text{ V}$  |        | 50<br>20 |          | mA<br>mA                       |
| $E_{as} (**)$  | Single Pulse Avalanche Energy | starting $T_j = 25\text{ }^\circ\text{C}$ $V_{DD} = 20\text{ V}$<br>$V_{in} = 10\text{ V}$ $R_{gen} = 1\text{ K}\Omega$ $L = 10\text{ mH}$ | 0.4    |          |          | J                              |

(\*) Pulsed: Pulse duration = 300  $\mu\text{s}$ , duty cycle 1.5 %

(\*\*) Parameters guaranteed by design/characterization

### PROTECTION FEATURES

During normal operation, the Input pin is electrically connected to the gate of the internal power MOSFET. The device then behaves like a standard power MOSFET and can be used as a switch from DC to 50 KHz. The only difference from the user's standpoint is that a small DC current ( $I_{ISS}$ ) flows into the Input pin in order to supply the internal circuitry.

The device integrates:

- **OVERVOLTAGE CLAMP PROTECTION:** internally set at 70V, along with the rugged avalanche characteristics of the Power MOSFET stage give this device unrivalled ruggedness and energy handling capability. This feature is mainly important when driving inductive loads.
- **LINEAR CURRENT LIMITER CIRCUIT:** limits the drain current  $I_d$  to  $I_{lim}$  whatever the Input pin voltage. When the current limiter is active, the device operates in the linear region, so power dissipation may exceed the capability of the heatsink. Both case and junction temperatures increase, and if this phase lasts long enough, junction temperature may reach the overtemperature threshold  $T_{jsh}$ .

- **OVERTEMPERATURE AND SHORT CIRCUIT PROTECTION:** these are based on sensing the chip temperature and are not dependent on the input voltage. The location of the sensing element on the chip in the power stage area ensures fast, accurate detection of the junction temperature. Overtemperature cutout occurs at minimum 150°C. The device is automatically restarted when the chip temperature falls below 135°C.
- **STATUS FEEDBACK:** In the case of an overtemperature fault condition, a Status Feedback is provided through the Input pin. The internal protection circuit disconnects the input from the gate and connects it instead to ground via an equivalent resistance of 100  $\Omega$ . The failure can be detected by monitoring the voltage at the Input pin, which will be close to ground potential.

Additional features of this device are ESD protection according to the Human Body model and the ability to be driven from a TTL Logic circuit (with a small increase in  $R_{DS(on)}$ ).

Thermal Impedance

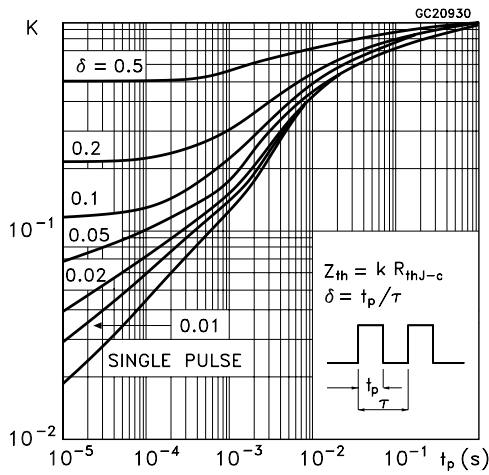

Derating Curve

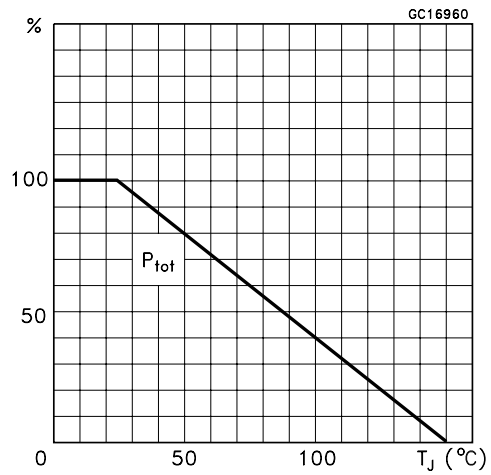

Output Characteristics

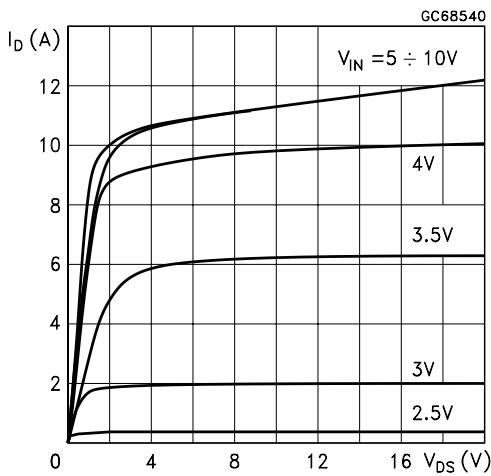

Transconductance

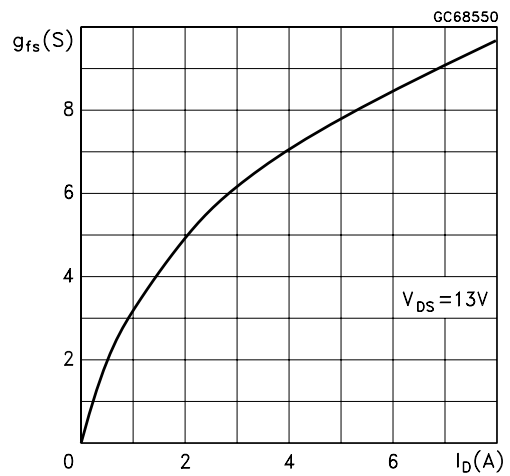

Static Drain-Source On Resistance vs Input Voltage

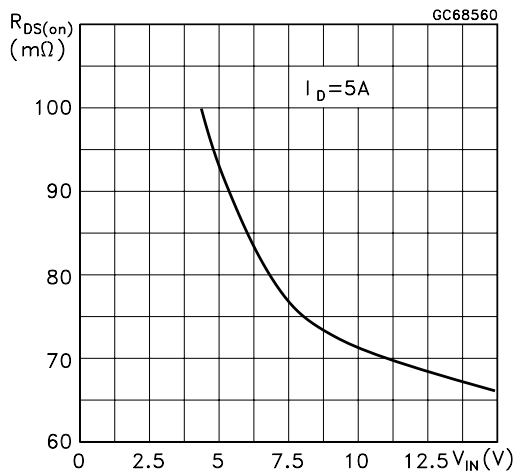

Static Drain-Source On Resistance

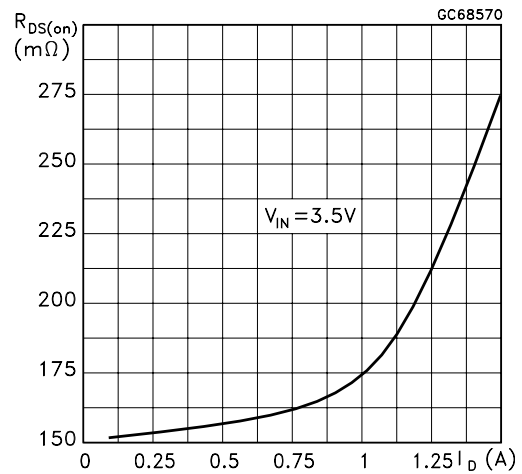

Static Drain-Source On Resistance

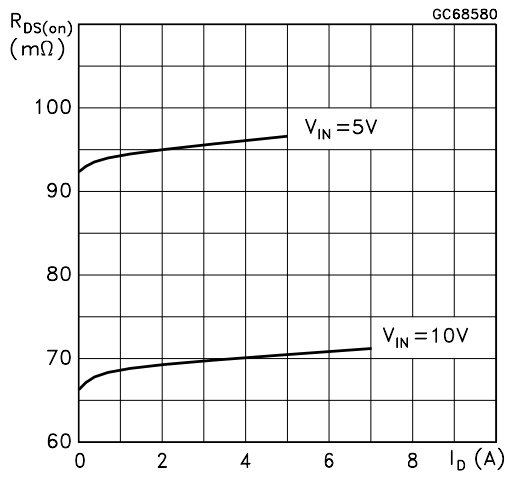

Input Charge vs Input Voltage

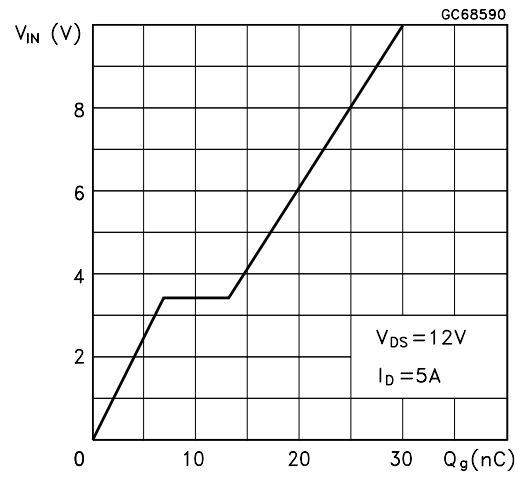

Capacitance Variations

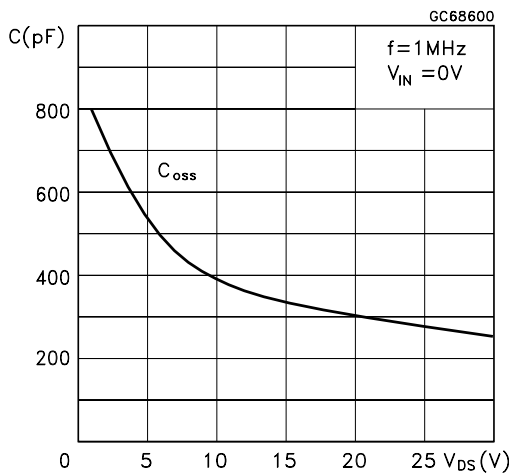

Normalized Input Threshold Voltage vs Temperature

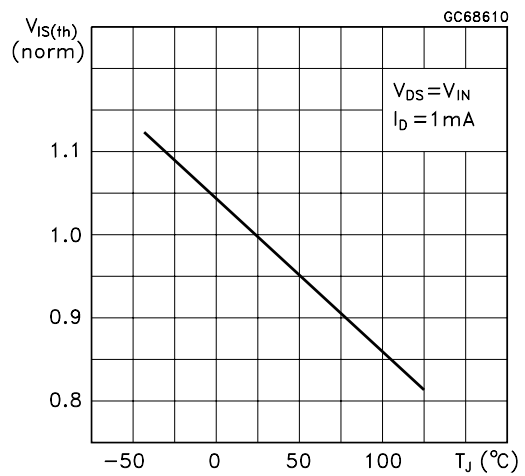

Normalized On Resistance vs Temperature

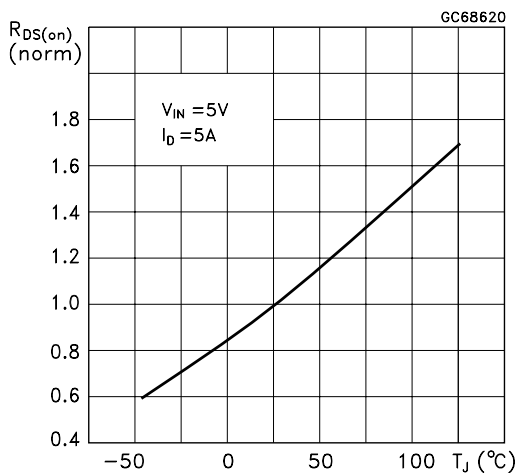

Normalized On Resistance vs Temperature

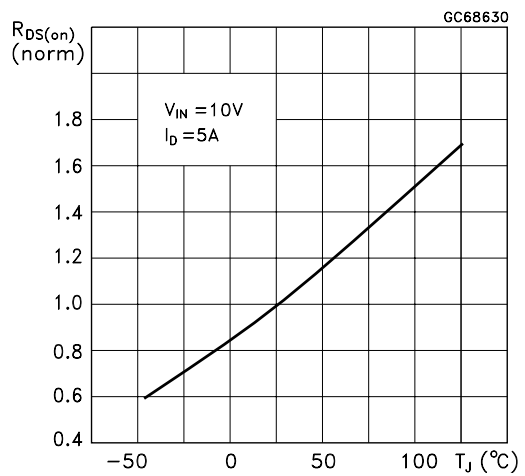

Turn-on Current Slope

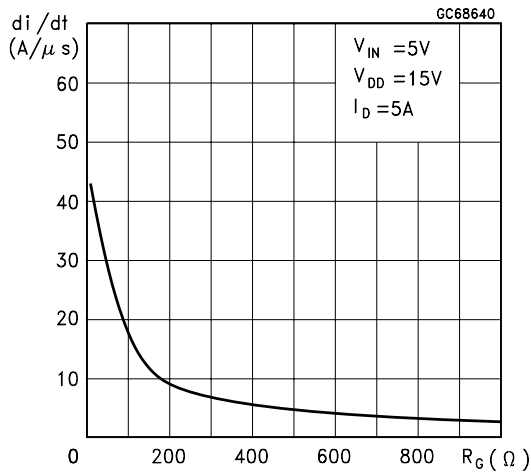

Turn-on Current Slope

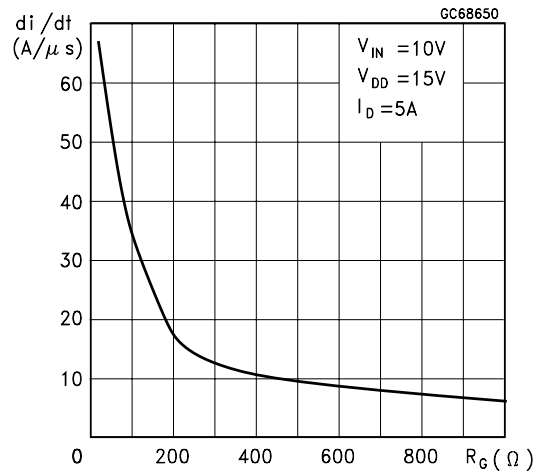

Turn-off Drain-Source Voltage Slope

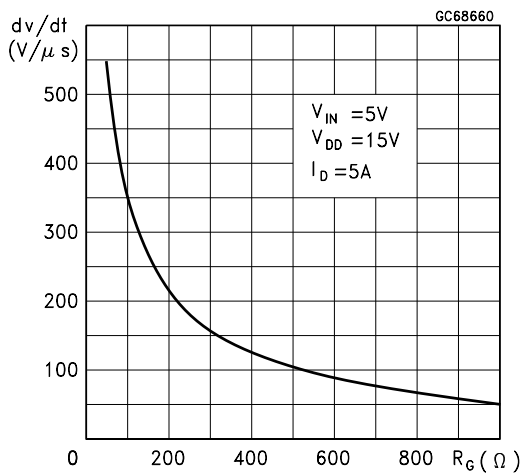

Turn-off Drain-Source Voltage Slope

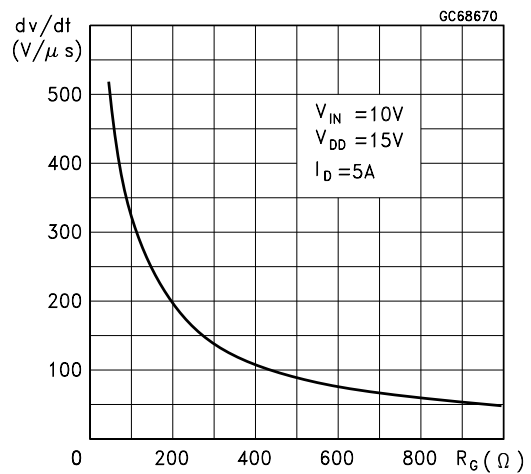

Switching Time Resistive Load

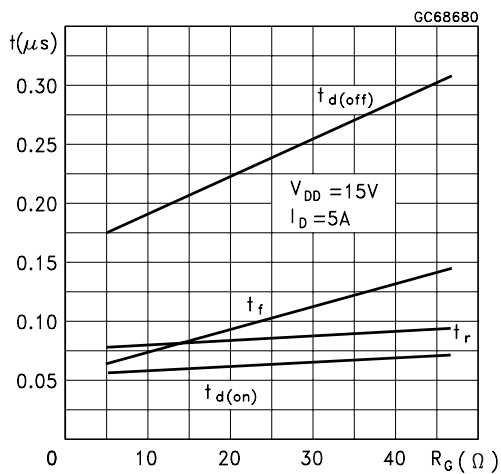

Switching Time Resistive Load

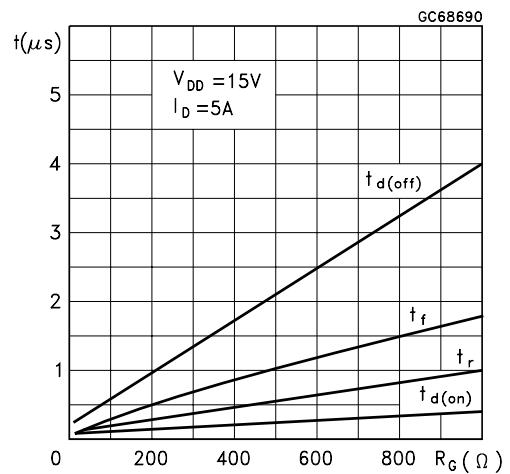

Switching Time Resistive Load

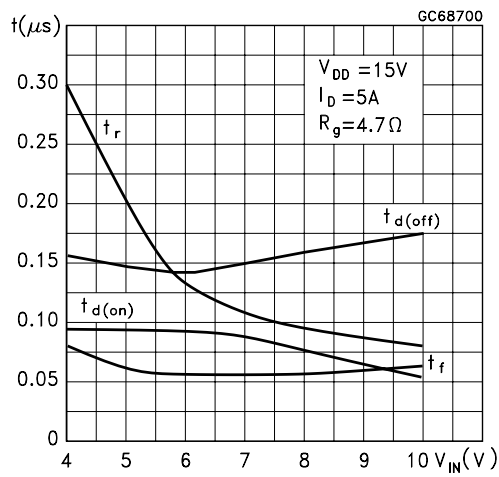

Current Limit vs Junction Temperature

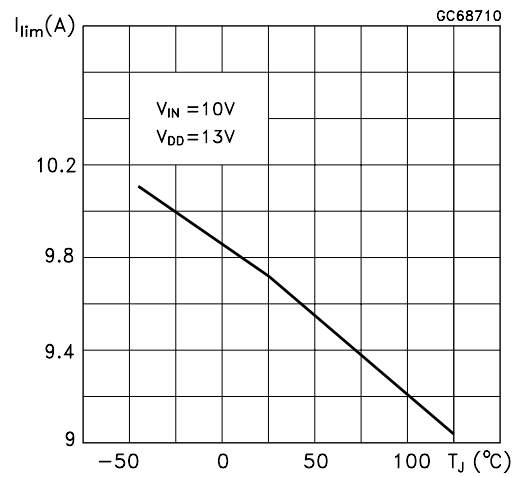

Step Response Current Limit

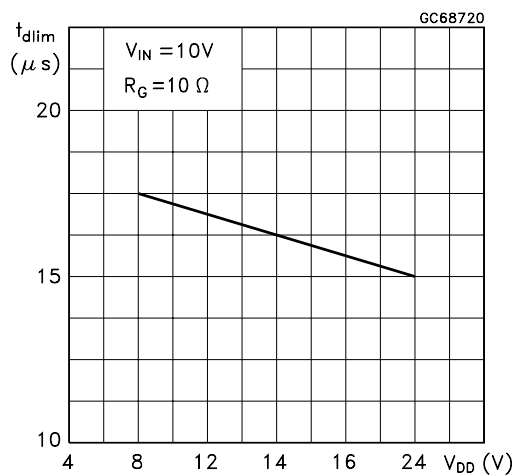

Source Drain Diode Forward Characteristics

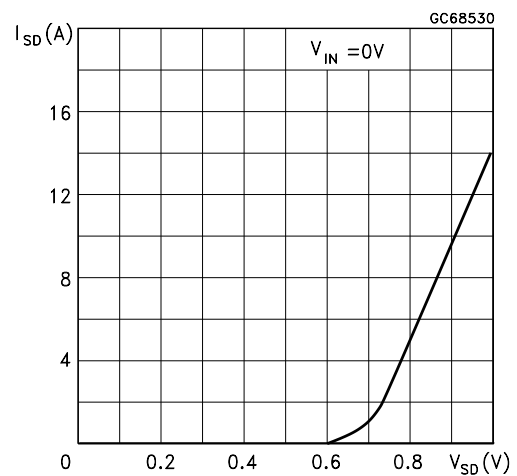
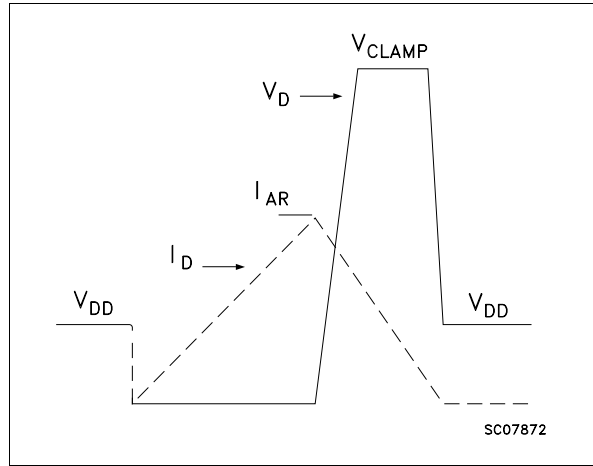



**Fig. 1: Unclamped Inductive Load Test Circuits**



**Fig. 2: Unclamped Inductive Waveforms**



**Fig. 3: Switching Times Test Circuits For Resistive Load**



**Fig. 4: Input Charge Test Circuit**

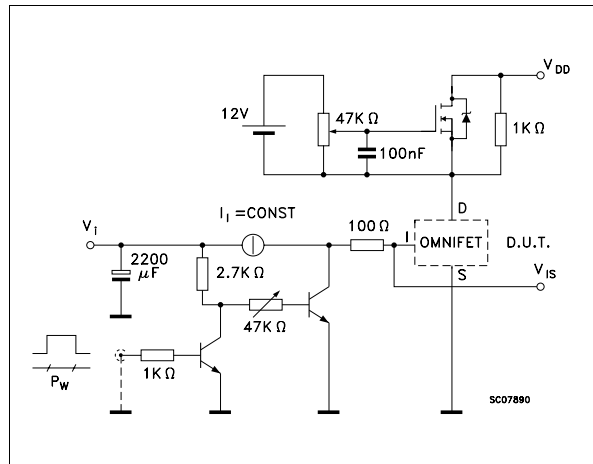

**Fig. 5: Test Circuit For Inductive Load Switching And Diode Recovery Times**



**Fig. 6: Waveforms**

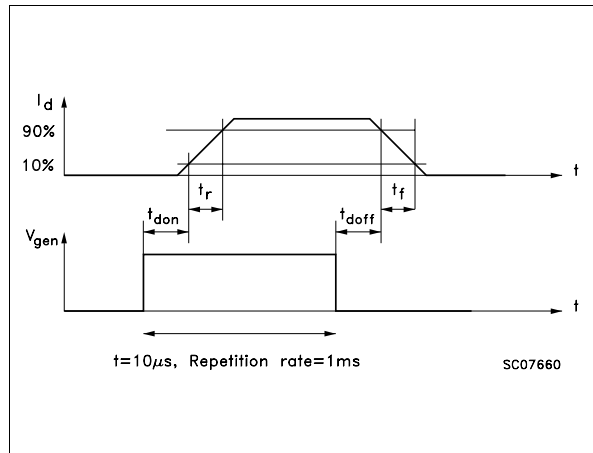

**TO-220 MECHANICAL DATA**

| DIM.           | mm.           |       |       |
|----------------|---------------|-------|-------|
|                | MIN.          | TYP   | MAX.  |
| A              | 4.40          |       | 4.60  |
| b              | 0.61          |       | 0.88  |
| b1             | 1.15          |       | 1.70  |
| c              | 0.49          |       | 0.70  |
| D              | 15.25         |       | 15.75 |
| E              | 10            |       | 10.40 |
| e              | 2.40          |       | 2.70  |
| e1             | 4.95          |       | 5.15  |
| F              | 1.23          |       | 1.32  |
| H1             | 6.20          |       | 6.60  |
| J1             | 2.40          |       | 2.72  |
| L              | 13            |       | 14    |
| L1             | 3.50          |       | 3.93  |
| L20            |               | 16.40 |       |
| L30            |               | 28.90 |       |
| ØP             | 3.75          |       | 3.85  |
| Q              | 2.65          |       | 2.95  |
| Package Weight | 1.9Gr. (Typ.) |       |       |



Information furnished is believed to be accurate and reliable. However, STMicroelectronics assumes no responsibility for the consequences of use of such information nor for any infringement of patents or other rights of third parties which may result from its use. No license is granted by implication or otherwise under any patent or patent rights of STMicroelectronics. Specifications mentioned in this publication are subject to change without notice. This publication supersedes and replaces all information previously supplied. STMicroelectronics products are not authorized for use as critical components in life support devices or systems without express written approval of STMicroelectronics.  
The ST logo is a trademark of STMicroelectronics

© 2004 STMicroelectronics - Printed in ITALY- All Rights Reserved.

**STMicroelectronics GROUP OF COMPANIES**

Australia - Brazil - Canada - China - Finland - France - Germany - Hong Kong - India - Israel - Italy - Japan - Malaysia -  
Malta - Morocco - Singapore - Spain - Sweden - Switzerland - United Kingdom - U.S.A.

<http://www.st.com>

