

SPECIFICATIONS

CONTACT RATING: 5A @125 VAC or 28 VDC (Q contact)
 ELECTRICAL LIFE:50,000 make-and-break cycles at full load
 CONTACT RESISTANCE: 10 mΩ max. initial @2-4 VDC,100 mA
 INSULATION RESISTANCE: 1,000 MΩ min.
 DIELECTRIC STRENGTH: 1,500 V RMS @ sea level.
 OPERATING TEMPERATURE: -30°C to +85°C

MATERIALS

CASE - diallyl phthalate (DAP)
 TOGGLE HANDLE - Copper alloy , chrome plated
 BUSHING - Copper alloy , nickel plated
 HOUSING - Stainless Steel
 CONTACT AND TERMINAL - copper alloy, silver plated

How do you build the switches you need!!

The straight type , please see the (A) ;

The right angle P.C terminals, please see the (B)

(A) **T 8 0 1 3** - **S** **E** **C** **Q** - **E** - **S 2 0** - **T 1** - **2** - -

Switch Function		Actuator		Bushing		Termination		Vertical support Bracket		Cap color	
T8013	SP on-none-on	S	10.41	E	(STD) 8.89	B	solder lug	(none)		0	transparent
T8013A	SP on-none-(on)	T	5.08	M	(non-thd) 8.89	C	P.C 1.27width	S20	11.68	1	white
T8014	SP on-off-on	X	13.97	K	(metric) 8.89	D	Quick connect	S25	16.00	2	black
T8014A	SP (on)-off-(on)	W	21.34	F		D1	wire wrap(19.05)	S35	11.68	3	red
T8014B	SP on-off-(on)	V	16.26	N	(non-thd) 7.10	D3	wire wrap(10.8)	S40	16.00	4	yellow
T8011	DP on-none-on	Y	21.34	G				V20	snap-in 11.68	5	blue
T8011A	DP on-none-(on)			H1	(non-thd) 7.52			V25	snap-in 16.00	6	green
T8012	DP on-off-on	Flatted toggle		H2	(metric) 8.00			V35	snap-in 11.68	7	orange
T8012A	DP (on)-off-(on)	U	11.43	J	(long) 9.60	Contact Material		V40	snap-in 16.00	O Ring	
T8012B	DP on-off-(on)	U1	7.20	J1	(non-thd) 9.60	Q	silver plated	Actuator Cap/ Rubber hood Sealing		E6	(none) for inch thd (E bushing)
T8301	3P on-none-on	U2	21.30	L	(splash-proof) 7.47	R	gold plated	Rubber hood		RoHS code	
T8303	3P on-none-(on)	Large15/32 bushing		none		G	gold over silver	E1	for E Bushing	H = RoHS Compliant	
T8305	3P on-off-on	Z	11.68	the actuator: Z/Z1/Z3/Z4/LK/LK1 No requirement to choose the bushing unless the splash proof (L) ZL/Z1L/LKL/LK1L and the non-thd (N) LKN/LK1N		K	tin plated	E2	for Z/Z1 Bushing		
T8307	3P (on)-off-(on)	Z1	17.45			Epoxy seal		E3	for Z/Z1 Bushing		
T8309	3P on-off-(on)	Z3	antirotation (17.45)			(none) none seal		K1	for K bushing		
T8401	4P on-none-on	Z4	antirotation (11.68)			E epoxy seal		Actuator Cap			
T8403	4P on-none-(on)	Locking Lever						T1	10.58 (for actuator S)		
T8405	4P on-off-on	LK	Round top					T2	7.56 (for actuator T)		
T8407	4P (on)-off-(on)	LK1	Flat top								
T8409	4P on-off-(on)										
3 way position switches											
T812	SP3T on-on-on										
T812A	SP3T (on)-on-(on)										
T812B	SP3T on-on-(on)										
T845	DP3T on-on-on										
T847	DP3T (on)-on-(on)										
T849	DP3T on-on-(on)										

(B) **T 8 0 1 9 L** - **T** **N** **Q** - **E** - **S** - **T 2** - **2** - -

Horizon Right Angle	Vertical Right Angle	Switches Function	Actuator		Bushing		Contact Material		Actuator Cap		
T8019	T8019L	SP on-none-on	S	10.41	E	(STD) 8.89	Q	silver plated	(none)		
T8019A	T8019LA	SP on-none-(on)	T	5.08	M	(non-thd) 8.89	R	gold plated	T1	-10.58 (actuator S)	
T8020	T8020L	SP on-off-on	X	13.97	K	(metric) 8.89	G	gold over silver	T2	-7.56 (actuator T)	
T8020A	T8020LA	SP (on)-off-(on)	W	21.34	F		K	tin plated	Cap color		
T8020B	T8020LB	SP on-off-(on)	V	16.26	N	(non-thd) 7.10	Epoxy seal		0	transparent	
T8021	T8021L	DP on-none-on	Flatted toggle		G		(none) none seal	1	white		
T8021A	T8021LA	DP on-none-(on)	U	11.43	H1	(non-thd) 7.52	E	epoxy seal	2	black	
T8022	T8022L	DP on-off-on	U1	7.2	H2	(metric) 8.00	Support Bracket type		3	red	
T8022A	T8022LA	DP (on)-off-(on)	U2	21.30	J	(long) 9.60	(none) std.	4	yellow		
T8022B	T8022LB	DP on-off-(on)	Locking Lever		J1	(non-thd) 9.60	S	snap-in type	5	blue	
T8301P(A)	T8301P	3P on-none-on	LK	Round top(thd)	L	(splash-proof) 7.47	RoHS code		6	green	
T8303P(A)	T8303P	3P on-none-(on)	LK1	Flat top(thd)	none		H = RoHS Compliant		7	orange	
T8305P(A)	T8305P	3P on-off-on	the actuator: LK/LK1 No requirement to choose the bushing unless the splash proof (L) LKL/LK1L and the non-thd (N) LKN/LK1N								
T8307P(A)	T8307P	3P (on)-off-(on)									
T8309P(A)	T8309P	3P on-off-(on)									
T8401P	T8401P	4P on-none-on									
T8403P	T8403P	4P on-none-(on)									
T8405P	T8405P	4P on-off-on									
T8407P	T8407P	4P (on)-off-(on)									
T8409P	T8409P	4P on-off-(on)									
3 way position switches											
T822	T822L	SP3T on-on-on									
T822A	T822LA	SP3T (on)-on-(on)									
T822B	T822LB	SP3T on-on-(on)									
T845P	T845P	DP3T on-on-on									
T847P	T847P	DP3T (on)-on-(on)									
T849P	T849P	DP3T on-on-(on)									

SPDT



Model No.	Switching position		
T8013	ON	none	ON
T8013A	ON	none	(ON)
T8014	ON	OFF	ON
T8014A	(ON)	OFF	(ON)
T8014B	ON	OFF	(ON)
Term. Comm.	2-3	open	2-1

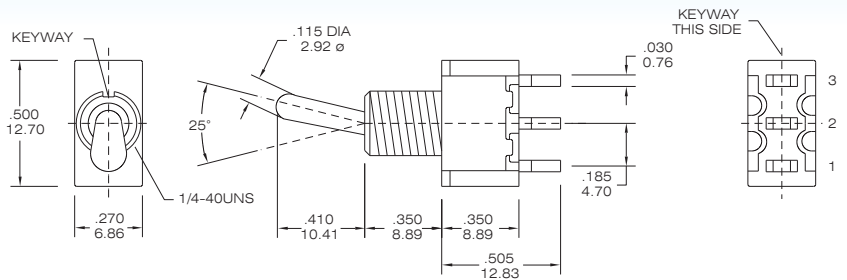

T8013 - SEBQ

DPDT



Model No.	Switching position		
T8011	ON	none	ON
T8011A	ON	none	(ON)
T8012	ON	OFF	ON
T8012A	(ON)	OFF	(ON)
T8012B	ON	OFF	(ON)
Term. Comm.	2-3,5-6	open	2-1,5-4
3 way switches (SP3T)			
T812	ON	ON	ON
T812A	(ON)	ON	(ON)
T812B	ON	ON	(ON)
Term. Comm.	2-3,5-6	2-3,5-4	2-1,5-4

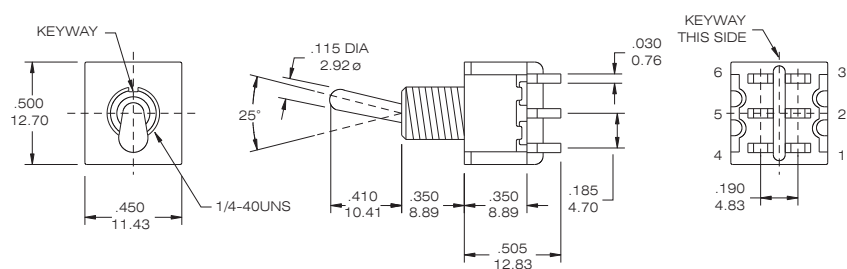

T8011 - SEBQ

Please see page A14 to know more about T812 (3-way Switches)

3PDT

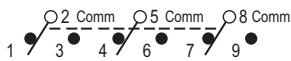

Model No.	Switching position		
T8301	ON	none	ON
T8303	ON	none	(ON)
T8305	ON	OFF	ON
T8307	(ON)	OFF	(ON)
T8309	ON	OFF	(ON)
Term. Comm.	2-3,5-6 8-9	open	2-1,5-4 8-7

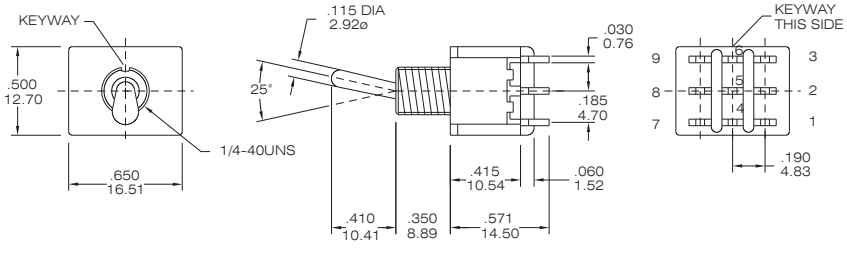

T8301- SEBQ

4PDT



Model No.	Switching position		
T8401	ON	none	ON
T8403	ON	none	(ON)
T8405	ON	OFF	ON
T8407	(ON)	OFF	(ON)
T8409	ON	OFF	(ON)
Term. Comm.	2-3,5-6 8-9,11-12	open	2-1,5-4 8-7,11-10
3 way switches (DP3T)			
T845	ON	ON	ON
T847	(ON)	ON	(ON)
T849	ON	ON	(ON)
Term. Comm.	2-3,5-6 8-9,11-12	2-3,5-4 8-9,11-10	2-1,5-4 8-7,11-10

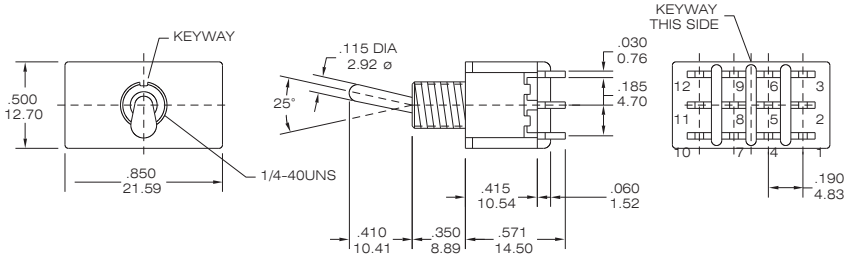

T8401 - SEBQ

Please see page A14 to know more about T845 (3-way Switches)

FEATURE

The T80-T series P.C.B Mounted Toggle Switches - Right Angle Type - are specially designed for P.C. Boards . Easy to mount and install securely with a vertical support rack . The toggle operates in the same direction as the print connectors . Customers' specifications of pitch are acceptable.

HORISON RIGHT ANGLE

SPDT



Model No.	Switching position		
T8019	ON	none	ON
T8019A	ON	none	(ON)
T8020	ON	OFF	ON
T8020A	(ON)	OFF	(ON)
T8020B	ON	OFF	(ON)
Term. Comm.	2-3	open	2-1

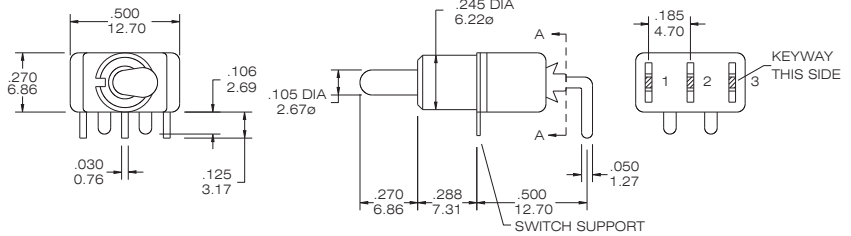

T8019 - TNQ

DPDT



Model No.	Switching position		
T8021	ON	none	ON
T8021A	ON	none	(ON)
T8022	ON	OFF	ON
T8022A	(ON)	OFF	(ON)
T8022B	ON	OFF	(ON)
Term. Comm.	2-3,5-6	open	2-1,5-4
3 way switches (SP3T)			
T822	ON	ON	ON
T822A	(ON)	ON	(ON)
T822B	ON	ON	(ON)
Term. Comm.	2-3,5-6	2-3,5-4	2-1,5-4

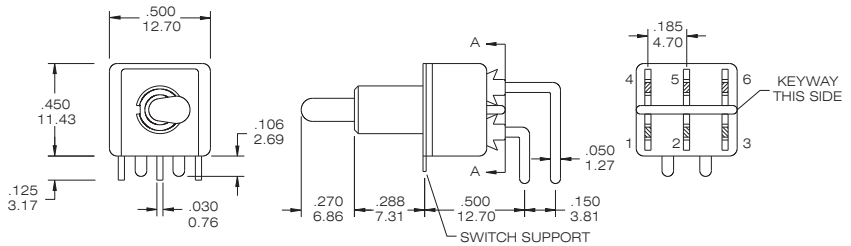

T8021 - TNQ
Please see page A14 to know more about T822 (3-way Switches)

3PDT



Model No.	Switching position		
T8301P(A)	ON	none	ON
T8303P(A)	ON	none	(ON)
T8305P(A)	ON	OFF	ON
T8307P(A)	(ON)	OFF	(ON)
T8309P(A)	ON	OFF	(ON)
Term. Comm.	2-3,5-6 8-9	open	2-1,5-4 8-7

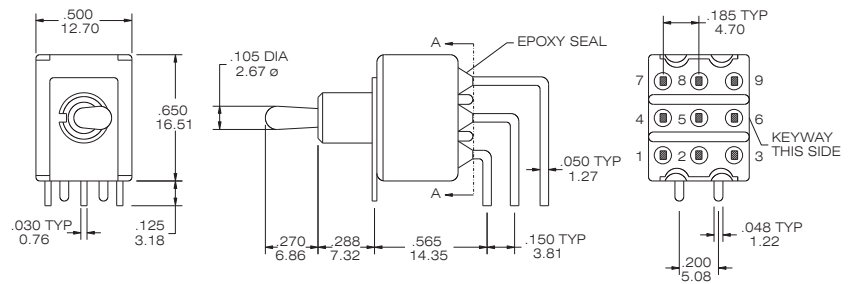

T8301P(A)- TNQ

P.C.B MOUNTING DIMENSIONS

FOR T8019-T8020B

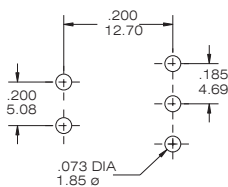

FOR T8021-T8022B

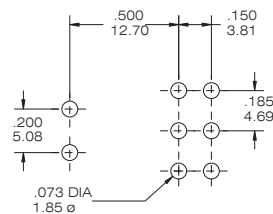

FOR T8301P(A)-T8309P(A)

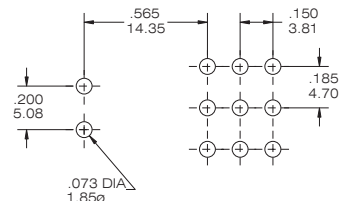



VERTICAL RIGHT ANGLE

SPDT

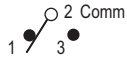

Model No.	Switching position		
T8019L	ON	none	ON
T8019LA	ON	none	(ON)
T8020L	ON	OFF	ON
T8020LA	(ON)	OFF	(ON)
T8020LB	ON	OFF	(ON)
Term. Comm.	2-3	open	2-1

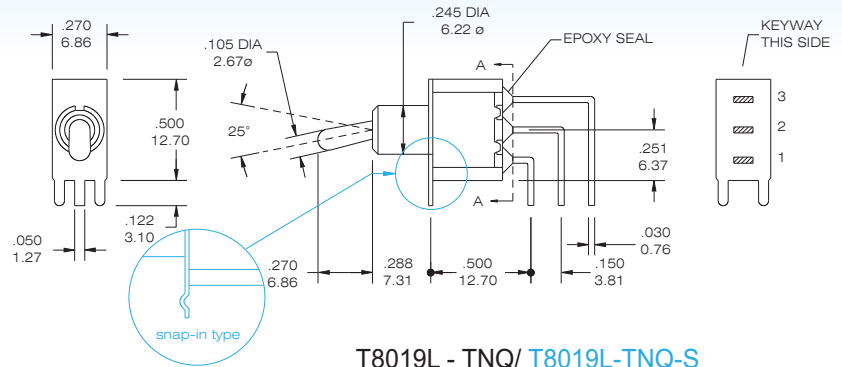

T8019L - TNQ/ T8019L-TNQ-S

DPDT



Model No.	Switching position		
T8021L	ON	none	ON
T8021LA	ON	none	(ON)
T8022L	ON	OFF	ON
T8022LA	(ON)	OFF	(ON)
T8022LB	ON	OFF	(ON)
Term. Comm.	2-3,5-6	open	2-1,5-4
3 way switches (SP3T)			
T822L	ON	ON	ON
T822LA	(ON)	ON	(ON)
T822LB	ON	ON	(ON)
Term. Comm.	2-3,5-6	2-3,5-4	2-1,5-4

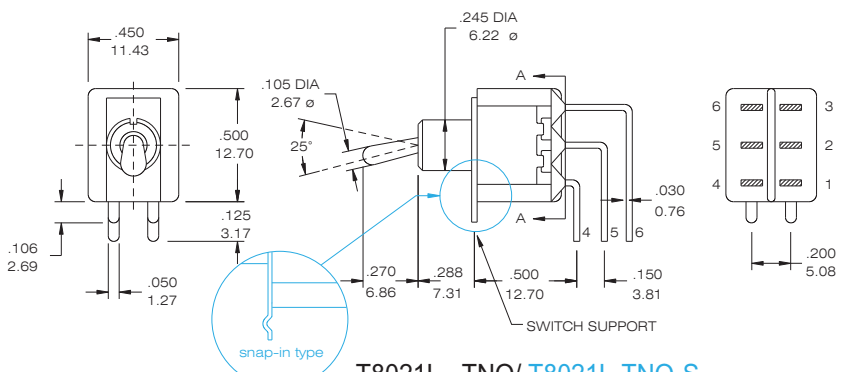

T8021L - TNQ/ T8021L-TNQ-S

Please see page A14 to know more about T822L (3-way Switches)

3PDT

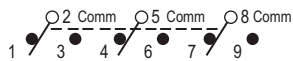

Model No.	Switching position		
T8301P	ON	none	ON
T8303P	ON	none	(ON)
T8305P	ON	OFF	ON
T8307P	(ON)	OFF	(ON)
T8309P	ON	OFF	(ON)
Term. Comm.	2-3,5-6 8-9	open	2-1,5-4 8-7

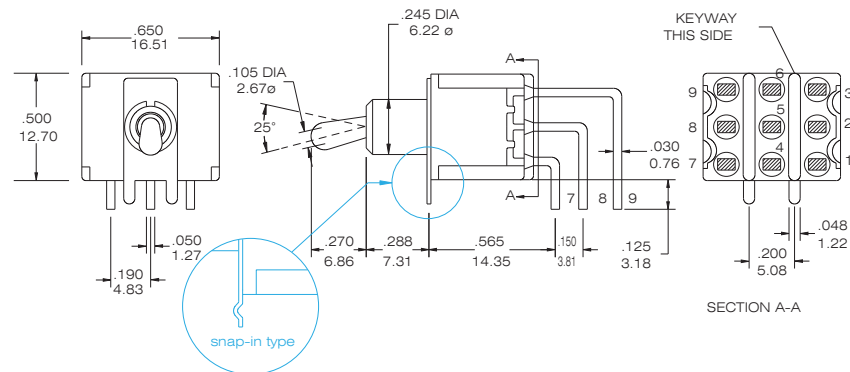

T8301P- TNQ/ T8301P-TNQ-S

4PDT



Model No.	Switching position		
T8401P	ON	none	ON
T8403P	ON	none	(ON)
T8405P	ON	OFF	ON
T8407P	(ON)	OFF	(ON)
T8409P	ON	OFF	(ON)
Term. Comm.	2-3,5-6 8-9,11-12	open	2-1,5-4 8-7,11-10
3 way switches (DP3T)			
T845P	ON	ON	ON
T847P	(ON)	ON	(ON)
T849P	ON	ON	(ON)
Term. Comm.	2-3,5-6 8-9,11-12	2-3,5-4 8-9,11-10	2-1,5-4 8-7,11-10

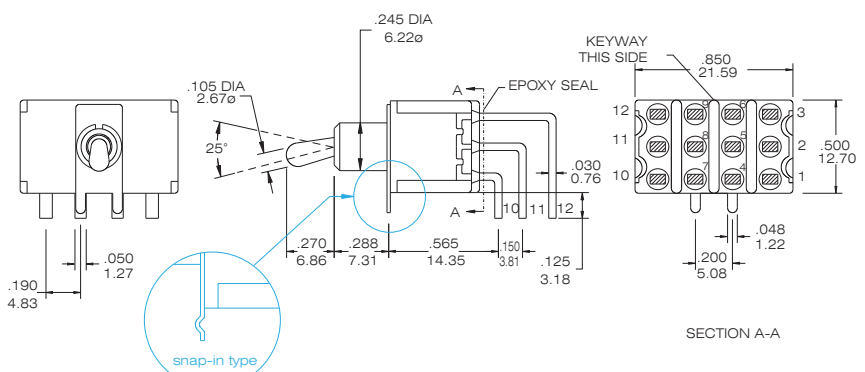

T8401P- TNQ/ T8401P-TNQ-S

Please see page A14 to know more about T845P (3-way Switches)

P.C.B MOUNTING DIMENSIONS

FOR T8019L-T8020LB

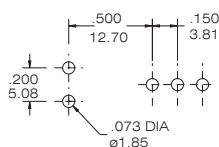

FOR T8021L-T8022LB

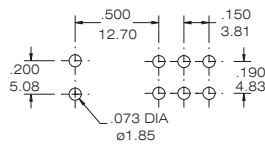

FOR T8301P-T8309P

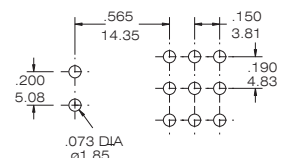

FOR T8401P-T8409P

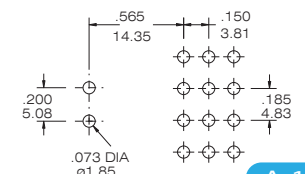

Actuator Option

S (STD)

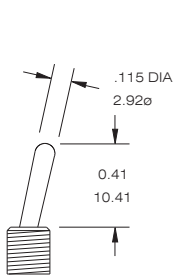

T(STD)

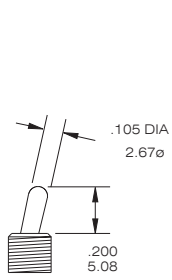

X LONG

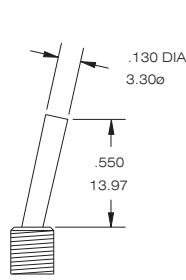

W LONG

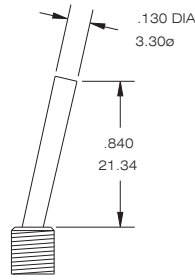

V LONG

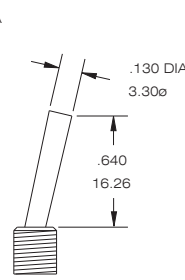

Y PLASTIC

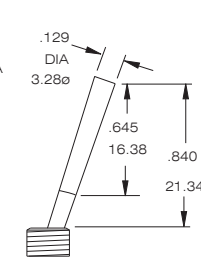

Y HANDLE COLOR NO.	COLOR
1	White
2	Black(std.)
3	Red

the height of actuator is with bushing "E". It will be difference with other bushing option

Now the available color is "2". If you need the others, please inquire first.

Flatted Actuator (ONLY APPLY "H""H1""H2" BUSHING)

U (standard)

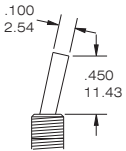

U1 (short)

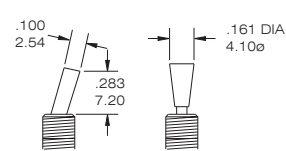

U2 (long)

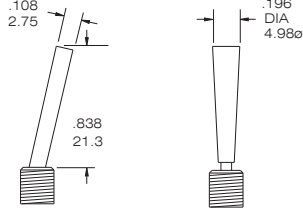

Locking Lever

LK (round top)

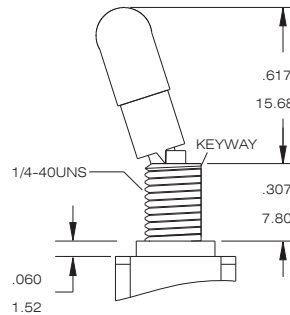

LK1(flat top)

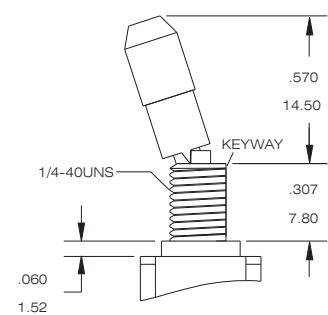

Bushing Option Code not required unless
 (1) " L " splashproof bushing ordered --LKL / LK1L
 (2) non-thread ordered,choose the bushing code "N" -- LKN / LK1N

Z LARGE TOGGLE
Z4 ANTIROTATION

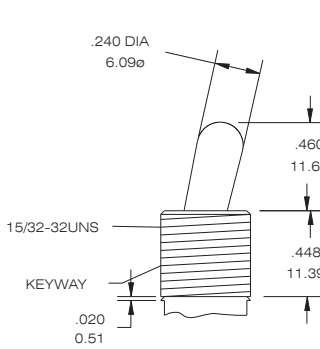

Z1 LARGE TOGGLE
Z3 ANTIROTATION

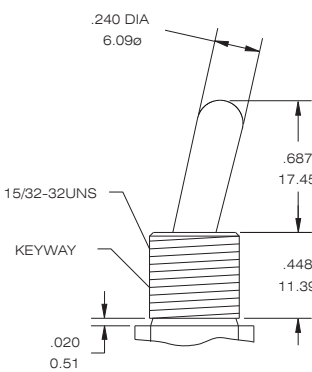

Bushing Option Code not required unless " L " splashproof bushing ordered.

Toggle Cap Option

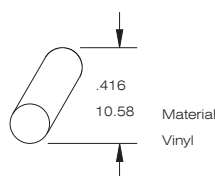

T1 for actuator "S"only

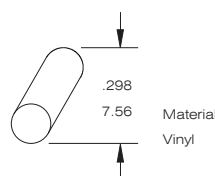

T2 for actuator "T"

Toggle Cap Color Option

code	color
0	transparent
1	white
2	black
3	red
4	yellow
5	blue
6	green
7	orange



Bushing Option

E THD STD. TYPE
M NON-THD

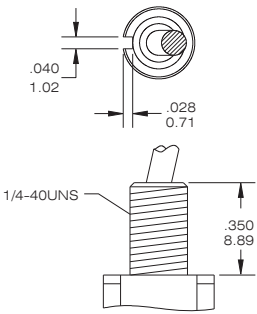

F THD.
N NON-THD

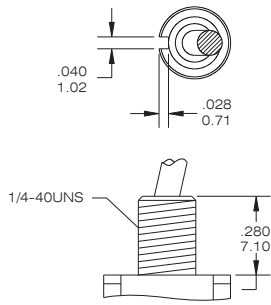

HIGH TORQUE
G:THD STD.TYPE
G1:NON-THD

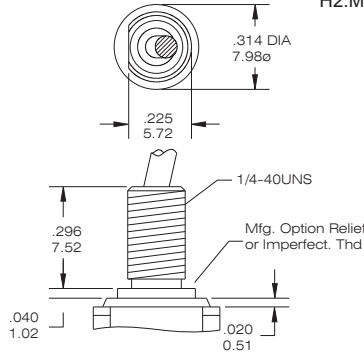

HIGH TORQUE
H:THD STD.TYPE
H1:NON-THD
H2:METRIC

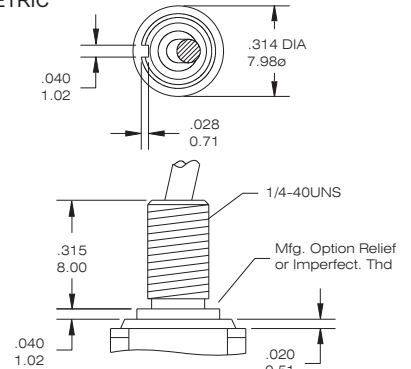

LONG
J:THD STD.TYPE
J1:NON-THD

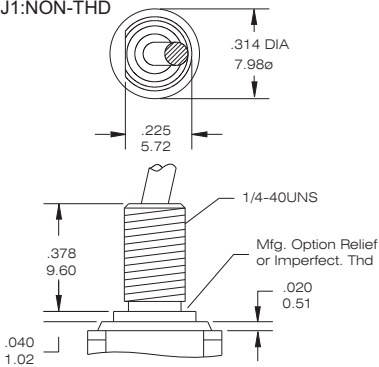

K METRIC

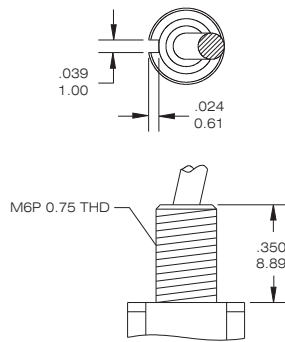

Splash water proof Solution
L SPLASH-PROOF

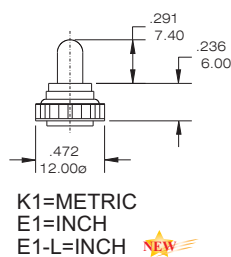
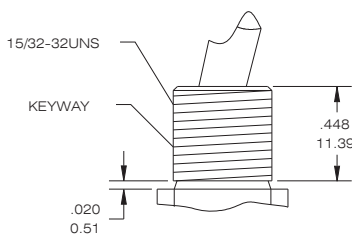
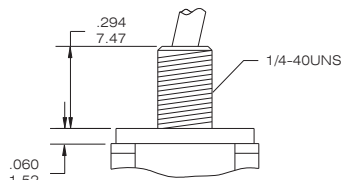
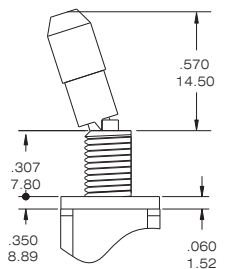
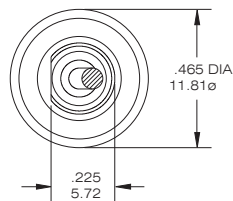
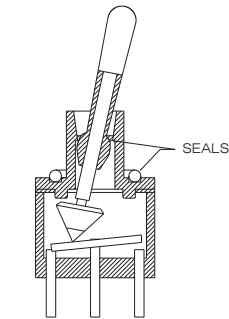

E2 for the large toggle
(15/32-32UNS)

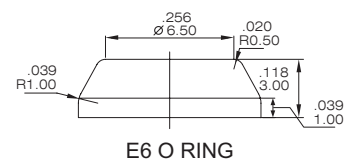
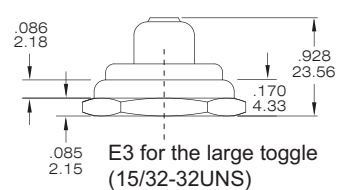
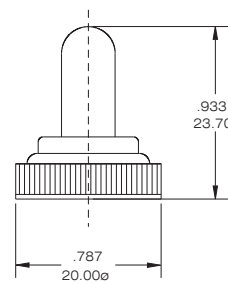

E3 for the large toggle
(15/32-32UNS)

E6 O RING

Panel Mounting

1/4 IN. BUSHING

without lock ring

with lock ring

METRIC BUSHING

15/32 IN. BUSHING

RUBBER HOOD SEALING

For the Large toggle (Z / Z1 option), the internal actuator seal standard. External bushingseal washer available from:Multi-Flex Seals Inc.,Hackensack,NJ. Part no:MFS-60064



TERMINAL OPTION (ONLY FOR THE STRAIGHT TYPE T8013~T8401)

TERMINAL SEAL OPTION

B SOLDER LUG C PRINTED CIRCUIT D QUICK CONNECT WIREWRAP

E TERMINAL SEAL

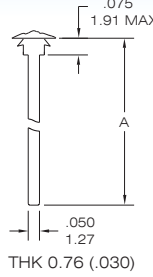
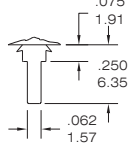
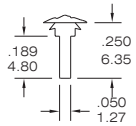
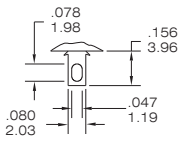

CODE	"A" dimension
D1	.750 (19.05)
D3	.425 (10.8)

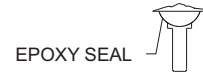

EPOXY SEAL

THK 0.76 (.030)

THK 0.76 (.030)

THK 0.76 (.030)

THK 0.76 (.030)

CONTACT MATERIAL OPTIONS

CODE	CONTACT MATERIAL	TERMINAL MATERIAL	RATING
Q	Silver plated	Silver plated	5 A @ 125 V AC or 28 V DC; 3 A @ 250 VAC
R	Gold plated over nickel plated	Gold plated over nickel plated	0.4VA MAX @ 20 V AC or DC MAX
G	Gold plated over silver plated	Gold plated over silver plated	0.4 VA MAX @ 20 V AC or DC MAX or 5 A @ 125V AC or 28 VDC; 3 A @ 250 VAC
K	Gold plated over nickel plated	Tin over nickel plated	0.4VA MAX @ 20 V AC or DC MAX

* The K option is only for some special item. Please inquire first when you need the "K" option

VERTICAL SUPPORT BRACKET OPTION

(only apply the straight type terminal -page A-08. Please build the terminal option "c" code)

S20 / S25/ V20/V25



SPDT

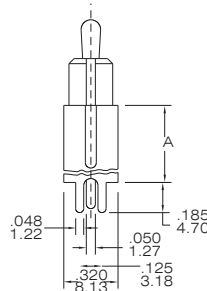
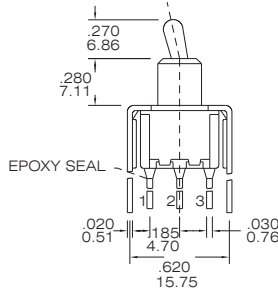

P.C. MOUNTING

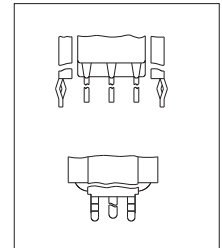
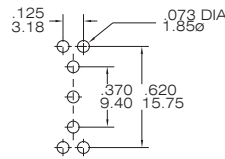

SNAP-IN
V20/ V25

T8013 - TNCQ-S20(S25)

DPDT

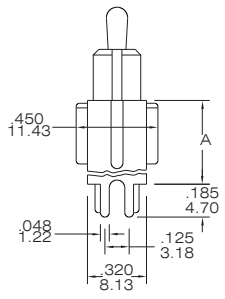
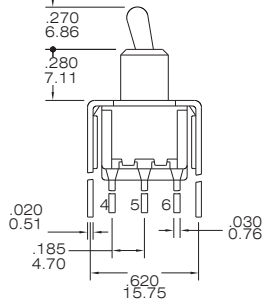

P.C. MOUNTING

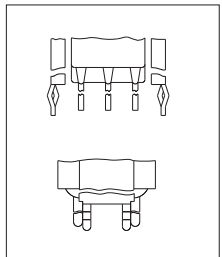
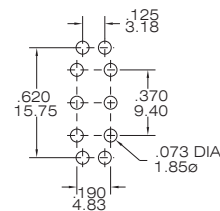

SNAP-IN
V20/ V25

T8011 - TNCQ-S20(S25)

option Code	A dimension
S20/V20	.460 11.68
S25/V25	.630 16.00

V20/V25 : the snap-in type

S35/S40 /V35/V40



SPDT

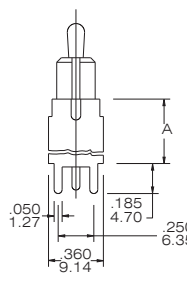
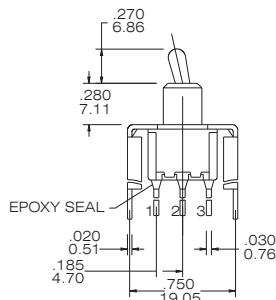

P.C. MOUNTING

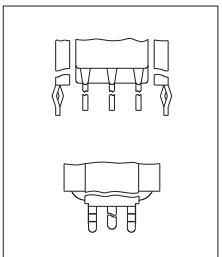
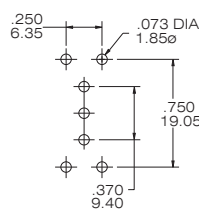

SNAP-IN
V35/ V40

T8013 - TNCQ-S35(S40)



option Code	A dimension
S35/V35	.460 11.68
S40/V40	.630 16.00
V35/V40 : the snap-in type	

DPDT

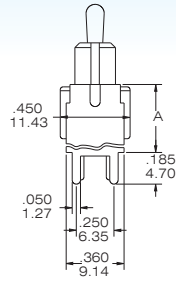
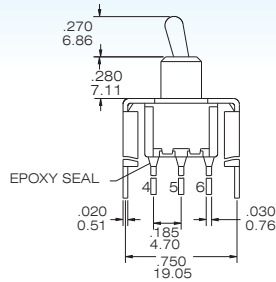

P.C. MOUNTING

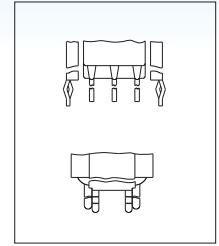
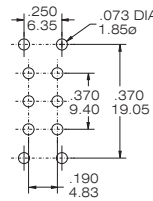

SNAP-IN
V35/ V40

T8011 - TNCQ-S35(S40)

The hardware of T80-T TOGGLE SWITCHES

NUT

STD.

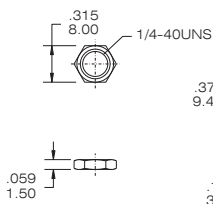

DRESS NUT

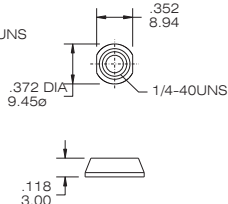

METRIC NUT

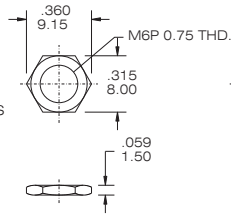

STD. FOR Z Z1

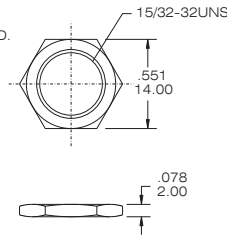

DRESS NUT FOR Z Z1

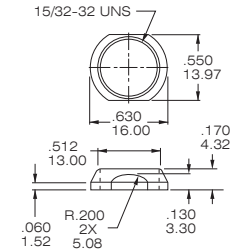

KNURLED NUT

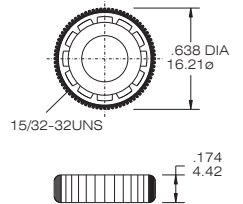

STD

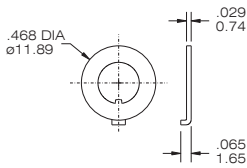

LOCKING RING

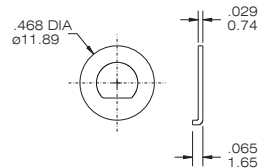

STD. FOR Z Z1

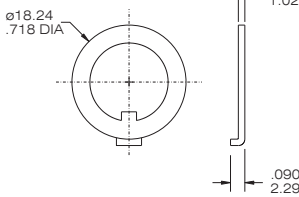

LOCK WASHER

STD.

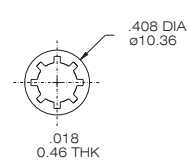

STD. FOR Z Z1

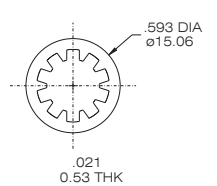

The information of 3-way toggle switches

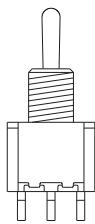
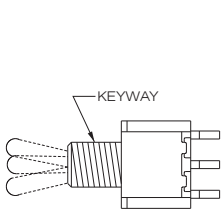

SINGLE POLE, 3 POSITION

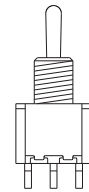
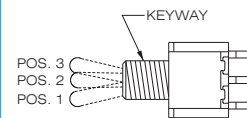
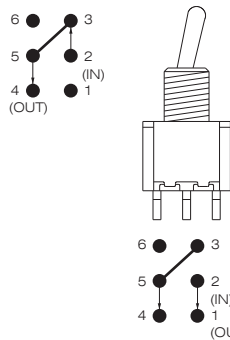
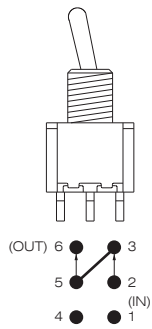
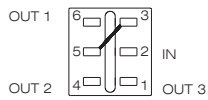

DOUBLE POLE, 3 POSITION

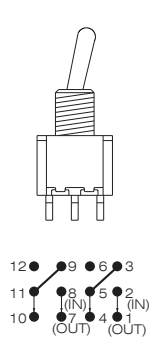
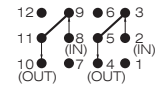
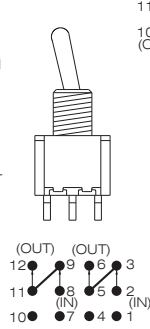
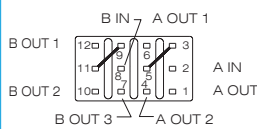

SP3T

DP3T