



**User manual**  
**RFID USB Desk**  
**Mif, Uni, iCla, Ico, Hit**



Soft >= 1.13

## **Dear Customer!**

Thank you very much for choosing our product. Before its use, please read these instructions carefully. There are given here the most appropriate ways of dealing with this device, the basic principles of safety and maintenance. Please also keep the user manual so that you can read it during later use.

### **Attention!**

**The manufacturer is not liable for any damage caused by improper use of the device which differ from its intended purpose, or improper handling, as well as a fault of driver resulting from improper use.**

## Table of contents:

<b>1 PRELIMINARY INFORMATION.....</b>	<b>4</b>
<b>2 DEVICE DESCRIPTION.....</b>	<b>5</b>
<b>3 WARRANTY AND LIABILITY OF THE MANUFACTURER.....</b>	<b>5</b>
<b>4 SAFETY GUIDELINES.....</b>	<b>6</b>
4.1 STORAGE, WORK AND TRANSPORT CONDITIONS.....	6
4.2 INSTALLATION AND USE OF THE DEVICE.....	6
4.3 DECOMMISSIONING OF THE DEVICE.....	6
<b>5 CONSTRUCTION OF THE DEVICE.....</b>	<b>7</b>
5.1 TECHNICAL DATA.....	7
5.2 GENERAL VIEW.....	8
5.3 GENERAL FEATURES.....	8
<b>6 CONFIGURATION BY THE "RFID CONFIG" PROGRAM.....</b>	<b>9</b>
6.1 LED & BUZZER.....	10
6.2 THE FORMATS OF THE CODE.....	11
6.3 READ DELAY.....	11
6.4 USB KEYBOARD EMULATOR HID.....	12
6.5 VIRTUAL COM PORT MODE CDC.....	14
6.6 ADVANCED TAG CONVERSION FUNCTIONS.....	15
6.7 READING MIFARE BLOCK.....	17
<b>7 RESTORE FACTORY SETTINGS.....</b>	<b>17</b>
<b>8 FIRMARE UPDATE.....</b>	<b>18</b>

## 1 Preliminary information

---

**Before starting work with the device, read The User manual and follow the instructions contained therein!**

Description of visual symbols used in this user manual:



This symbol is responsible for reviewing the appropriate place in the user instructions, warnings and important information. Failure to follow warnings could cause injury or damage to the device



Important information and guidelines



Following this guidelines makes the use of the device easier

**Attention:** The screenshots in this manual can be dissimilar from actual images at the time of the device purchase. Due to continuous development of the devices software, some of the functions may differ from these in the manual. The manufacturer claims no responsibility for any undesirable effects (misunderstanding) caused by changes of the software.

## 2 Device description

---

RFID USB Desk is a reader of RFID transponders in following standards:

- Unique EM4100 EM4102,
- Mifare Classic® (ISO/IEC 14443-A), Mifare Plus® (UID), Mifare DESFire® (UID),
- HID iClass® (tylko CSN),
- ICODE® (ISO 15693),
- HITAG (HITAG 1/HITAG 2/HITAG S).

The device read the UID code and depending on configuration it can perform advanced conversion of it. The module allows for addition of Prefix and Postfix such as a character, words or special signs (eg. Enter) The RFID USB Desk can also read a content of certain transponders.

## 3 Warranty and liability of the manufacturer

---



The manufacturer provides a 2-year warranty on the device. The manufacturer also provides post-warranty service for 10 years from the date of the introducing the device on the market. The warranty covers all defects in material and workmanship.

The manufacturer undertakes to comply with the contract of guarantee, if the following conditions are met:

- all repairs, alterations, extensions and device calibrations are performed by the manufacturer or authorized service,
- supply network installation meets applicable standards in this regard,
- the device is operated in accordance with the recommendations outlined in this manual,
- the device is used as intended.

The manufacturer assumes no responsibility for consequences resulting from improper installation, improper use of the device, not following this manual and the repairs of the device by individuals without permission.



**This device doesn't contain serviceable parts.**

## 4 Safety guidelines

---

The device has been designed and built using modern electronic components, according to the latest trends in the global electronics. In particular, much emphasis was placed on ensuring optimum safety and reliability of control. The device has a housing with a high-quality plastic.

### 4.1 Storage, work and transport conditions

The controller device has to be stored in enclosed rooms which are free of caustic vapors and substances and also meet the requirements:

- surrounding temperature from +5°C to +45°C,
- humidity from 25% to 95%,
- atmospheric pressure from 700 to 1060hPa.

The device working conditions:

- surrounding temperature from +10°C to +30°C,
- relative humidity from 30% to 75%,
- atmospheric pressure from 700 to 1060hPa.

Recommended transport conditions:

- surrounding temperature from -10°C to +45°C,
- humidity from 20 to 95%,
- atmospheric pressure from 700 to 1060hPa.

### 4.2 Installation and use of the device

 **The device should be used following the guidelines shown in next part of the user manual.**

### 4.3 Decommissioning of the device

When it becomes necessary to recycle the device (for instance, to decommission the device from service), please contact the manufacturer or its representative, who are obliged to respond, appropriately, i.e. collecting the device from the user. You can also ask the companies involved in recycling of electrical or computer equipment. Under no circumstances should you place the device along with other waste material.

## 5 Construction of the device

---

### 5.1 Technical data

*Power:*

USB 5VDC (the device is powered from the computer's USB port)

*Transponders, depending on the device version:*

Name of the reader	Supported transponders
RFID USB Desk Mif	Mifare Classic® (ISO/IEC 14443-A), Mifare Plus® (UID), Mifare DESFire® (UID)
RFID USB Desk Uni / RFID Pocket	Unique EM4100 EM4102
RFID USB Desk iCla	HID iClass® (tylko CSN)
RFID USB Desk Ico	ICODE® (ISO 15693)
RFID USB Desk Hit	HITAG (HITAG 1/HITAG 2/HITAG S)

*Communication:*

USB port (a Keyboard Emulator or Virtual Com Port)

*Dimensions:*

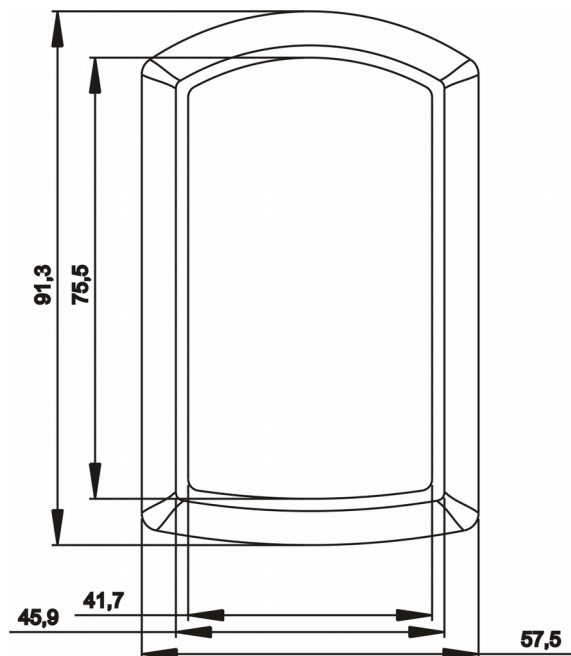

## 5.2 General view



## 5.3 General features

The reader is equipped with a USB port supporting the CDC (Virtual Com Port) and HID (keyboard) classes.

The device has three LEDs and a sounder.

The LEDs can be turned off or react to:

- reading the TAG,
- application of the TAG,
- power connection.

The sounder can be turned off or can generate a signal after reading the RFID TAG.



## 6 Configuration by the "RFID Config" program

In order to configure the device download the free INVEO "RFID Config" program from <http://inveo.com.pl>. The software can be found in the Download tab.

After installing and running the program, connect the reader to the computer. At the bottom of the application, the current status of the USB port to which the device is connected along with the basic information about the reader should be displayed.

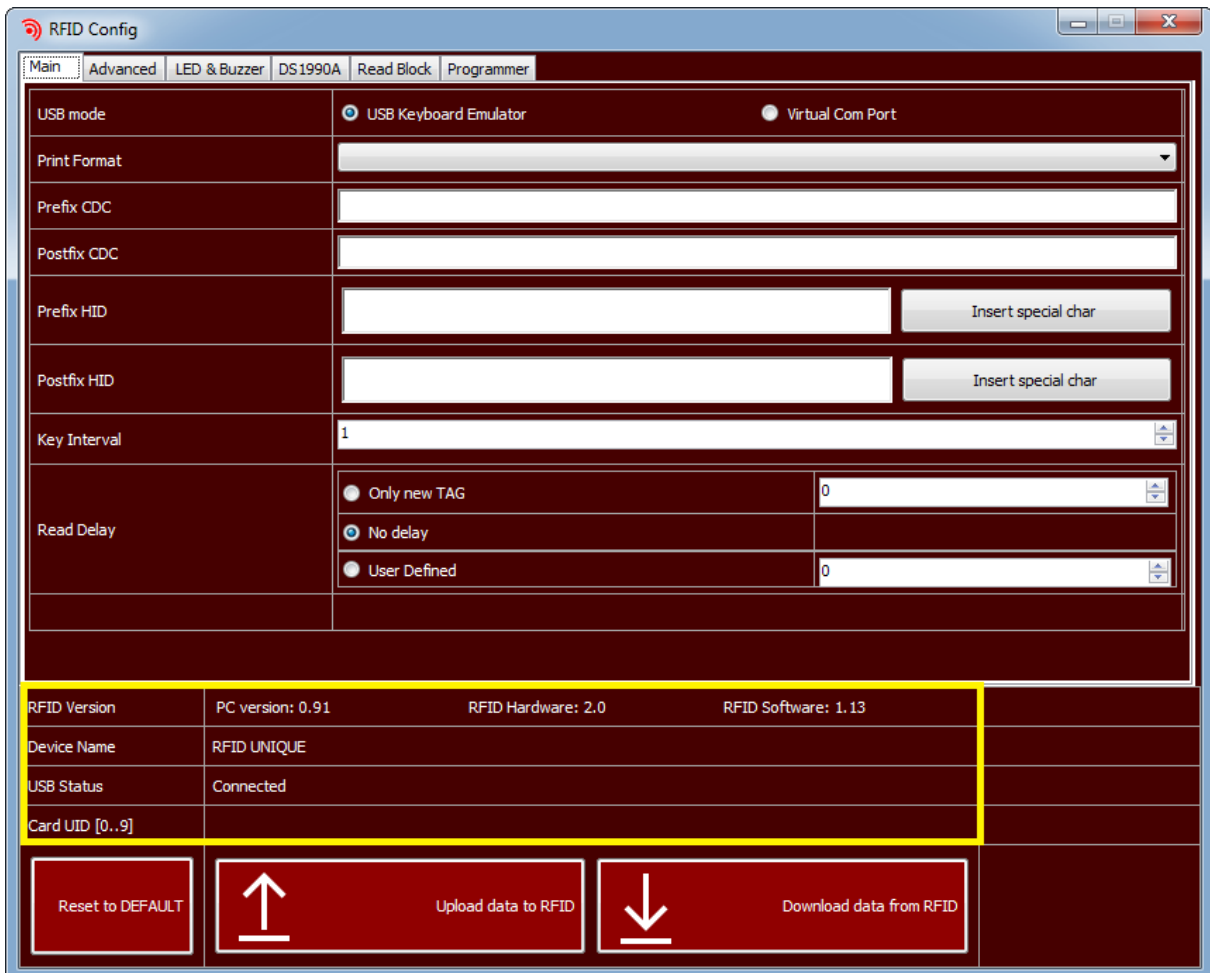

If the reader has been detected by the program, proceed to configuration.



### 6.1 LED & Buzzer

To set up the LED and sound signaling proceed to the **LED & Buzzer** tab and choose the required settings.

Two options can be set for the sound signaling (Buzzer):

- OFF
- ON READ – sound signaling at the moment of reading the TAG.

The device has 3 LEDs:

Icon	Name	Description
	LED 1	In the basic configuration informs about connecting the power supply to the module. Color green.
	LED 2	In the basic configuration the LED is not used. Color red.
	LED 3	In the basic configuration informs about the correct reading of the code. Color green.

The user can configure the LEDs according to his own needs. Each LED can be configured in 4 ways:

- **ON** – the LED lights continuously when power is supplied,
- **OFF** – the LED is off
- **ON READ** – the LED signals the TAG reading,
- **IN FIELD** – the LED signals the TAG's application to the reader, the LED is on when the TAG is within range of the module.



## 6.2 The formats of the code

The **RFID Config** application allows to specify the format in which the UID code will be presented (**Print format**).

The screenshot shows the 'Programmer' tab of the RFID Config application. The 'Print Format' dropdown menu is open, displaying the following options: Binary, HEX LowerCase Letter, HEX UpperCase Letter, HEX UpperCase Letter Minus (highlighted), Decimal, and ASCII. The 'USB mode' section shows 'USB Keyboard Emulator' selected over 'Virtual Com Port'.

The following output data formats are available:

- **Binary** – a code in a binary form available (only in Virtual Com Port mode),
- **HEX LowerCase Letter** – a code in hexadecimal format with lowercase letters
- **HEX UpperCase Letter** – a code in hexadecimal format with uppercase letters
- **HEX UpperCaseLetter Minus** – code in hexadecimal format with uppercase letters and with minus separating bytes of code,
- **Decimal** – conversion of a code to decimal format,
- **ASCII** – decoding of data stored in the transponder from the ASCII format (applies to the Mifare standard). The string must end with "0".

More settings regarding conversions TAG are described in the chapter 6.6.

## 6.3 Read delay

To set up the read delay of reading new TAG, use proper settings in the **Main** tab.

The screenshot shows the 'Main' tab of the RFID Config application. The 'Key Interval' is set to 100. The 'Read Delay' section has three radio button options: 'Only new TAG' (selected), 'No delay', and 'User Defined'. The 'User Defined' option has a value of 20.

There are 3 ways to delay reading (**Read Delay**):

- **Only new TAG** – reading the same TAG is possible only after the defined time has passed, while another TAG is read immediately. This means that the same card will not be accidentally read several times. Delay time expressed in  $x * 0.1s$ .
- **No delay** – there is no read delay. The TAG reading takes place every 0.5s.
- **User Defined** – the possibility to set the desired TAG reading delay. Delay time expressed in 0.1s.

If the device to which the reader is connected is old, so it does not work fast enough to correctly write out the UID code or characters entered in the Prefix / Postfix field (do not display all elements), define a longer interval between the characters (**Key Interval**). The default value is 10.

## 6.4 USB Keyboard Emulator HID

The **Main** tab contains the main settings of the reader's operating mode. Using the keyboard emulator mode, the reader treats the reader as a standard keyboard.

To set the reader in the emulator mode, select the **USB Keyboard Emulator** option in the **Main** tab.

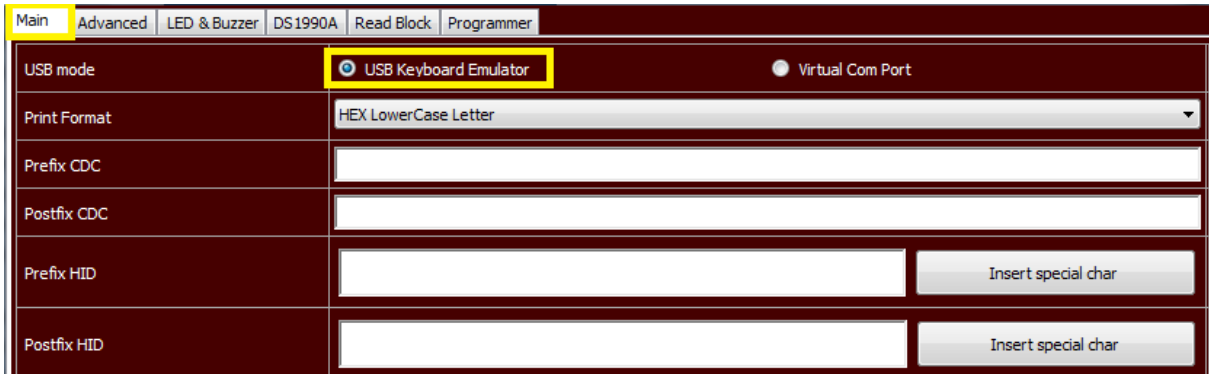

The **Prefix CDC** and **Postfix CDC** fields are used in the Virtual Com Port mode (chapter 6.5).

Using the keyboard emulator mode, the user can define:

- **Prefix HID** – it is a string of characters (eg letters, numbers) or special characters (Alt key, Enter key, key combination), which are called before printing the ID,
- **Postfix HID** – it is a string of characters (eg letters, numbers) or special characters (Alt key, Enter key, key combination), which are called after printing the ID.

To define a special character, press the button **Insert special char**.



A dialog box with a virtual keyboard will be displayed.

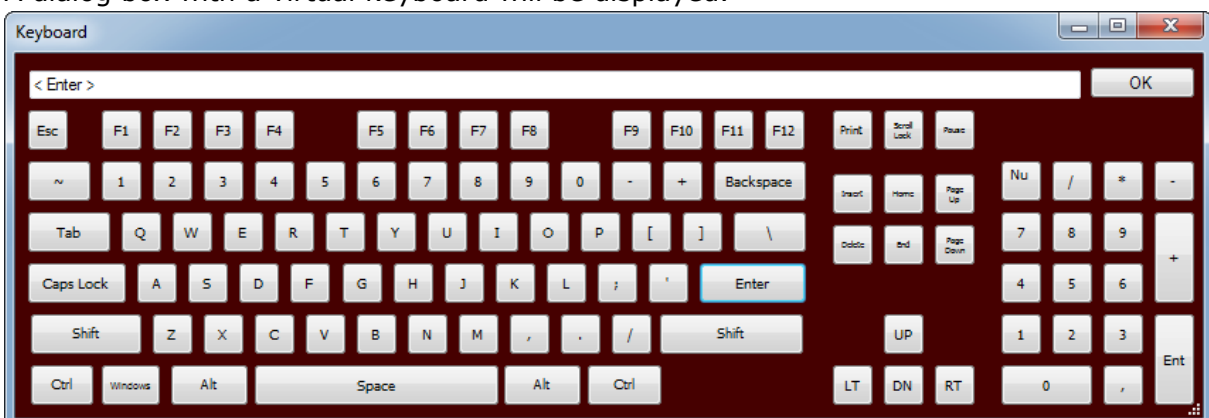

Using the virtual keyboard window you can create any string of characters and key combinations.

**Example:**

When the card is applied, the reader has to display the following sequence of characters: **User: (UID).** and the enter key.

First, the **Prefix HID** field is filled in with the word: "User:"

The **Prefix** field is as follows:

In the Postfix field, fill in ".", and then insert the enter key from the virtual keyboard.



The **Postfix** field is as follows:

To confirm the entered settings, it is necessary to send data by clicking the **Upload data to RFID** button.

After completing the above steps, each time a TAG is applied, the following character string will be sent:

„User: UIDnumber.  
“

## 6.5 Virtual Com Port mode CDC

The **Main** tab contains the main settings of the reader's operating mode. Using the **Virtual Com Port** mode, the reader after applying the TAG sends its code to the Virtual Com Port.

To set the reader in the Virtual Com Port mode, select **Virtual Com Port** in the **Main** tab.



Using the Virtual Com Port mode, the user can define:

- **Prefix CDC** – it is a string of characters (e.g. letters, numbers, hex numbers) that are sent before printing the ID,
- **Postfix CDC** – it is a string of characters (e.g. letters, numbers, hex numbers) that are sent after printing the ID.

Using the Virtual Com Port mode, it is possible to control the buzzer and LED diodes.

Sending a byte to the Virtual Com Port causes the appropriate response:

Bit	7	6	5	4	3	2	1	0
Function	**	*						

\*Bit 6

0 – standard operating mode, code sent after applying the card

1 – code sent only on request

\*\*Bit 7

1 – request to send the card code

If the card is not in the reader field and a request is sent (Bit 7), the device does not return a value.

### Examples:

- To turn on the LED1 and LED3, send the value 5,
- To start the buzzer (continuous tone, bit 3), send the value 8,
- To start the buzzer (momentary sound, bit 5) and turn on the LED1 and LED3, send the value 37.

## 6.6 Advanced TAG conversion functions

The **Advanced** tab contains advanced settings for reading the code.

Main	Advanced	LED & Buzzer	DS1990A	Read Block	Programmer
Bit Negation	<input type="radio"/> ON				<input checked="" type="radio"/> OFF
Swap Byte	<input type="radio"/> ON				<input checked="" type="radio"/> OFF
Swap Bit	<input type="radio"/> ON				<input checked="" type="radio"/> OFF
Begin (bit)	<input type="text" value="0"/>				
End (bit)	<input type="text" value="127"/>				
Align	<input type="radio"/> LEFT				<input checked="" type="radio"/> RIGHT
Auto Length	<input type="radio"/> ON				<input checked="" type="radio"/> OFF
Padding	<input type="text" value="0"/>				
Predefined	<input type="radio"/> 3 Bytes	<input type="radio"/> 3,5 Bytes	<input type="radio"/> 4 Bytes	<input type="radio"/> 5 Bytes	<input checked="" type="radio"/> User defined
Alternative Scan Codes	<input checked="" type="radio"/> ON				<input type="radio"/> OFF

The application allows you to completely control the code. The following functions are available:

**Bit Negation** – selecting this option forces negation of read values:

TAG: 04-00-1B-B7-BC → TAG: FB-FF-E4-48-43,

**Swap Byte** –function that swap bytes:

TAG: 04-00-1B-B7-BC → TAG: BC-B7-1B-00-04,

**Swap Bit** – function that swap a sequence of bits:

TAG: 04-00-1B-B7-BC → TAG: 3D-ED-D8-00-20,

Exchange first bit of TAG with the last one, the second bit with one before last and so one.

04BChex → 0000 0100 1011 1100 bin → swapping bits →

0011 1101 0010 0000 bin → 3D20hex

**Begin (bit)** – the bit number from which the reader starts reading the UID code,

**End (bit)** – the bit number to which the reader is to perform the read operation.

Entering the wrong value in the **Begin / End (bit)** field will cause the TAG value to be completely changed, because the bits of each byte will be moved:

Example:

The UID code is in the range of 0-39. The user completed the fields as follows:

- Begin (bit) = 1,
- End (bit) = 40.

Begin	End	TAG (Bytes)	TAG (Bits)
0	39	04-00-1B-B7-BC	0100000000000011011101101111011100
1	40	08-00-37-6F-78	10000000000000110111011011110111000

The whole TAG **in bits** is moved so the value **in bytes** is completely different.

**Align** – alignment of the TAG,

Example 1:

Read 3,5 bytes from the TAG: 01-0F-A0-D2-61,

**Begin (bit)** = 12

**End (bit)** = 39

**Auto Length ON**

<b>Full TAG (Bytes)</b>	01-0F-A0-D2-61
<b>Full TAG (bits)</b>	00000001 00001111 10100000 11010010 01100001
<b>Byte to align</b>	XF-A0-D2-61
<b>Align OFF (B)</b>	FA-0D-26-10
<b>Align OFF (b)</b>	11111010 00001101 00100110 00010000
<b>Align ON (B)</b>	0F-A0-D2-61
<b>Align ON (b)</b>	00001111 10100000 11010010 01100001

Example 2:

Read 1,5 bytes from the TAG: 05-00-EE-9C-86,

**Begin (bit)** = 28

**End (bit)** = 39

**Auto Length ON**

<b>Full TAG (Bytes)</b>	05-00-EE-9C-86
<b>Full TAG (bits)</b>	00000101 00000000 11101110 10011100 10000110
<b>Byte to align</b>	XC-86
<b>Align OFF (B)</b>	C8-60
<b>Align OFF (b)</b>	11001000 01100000
<b>Align ON (B)</b>	0C-86
<b>Align ON (b)</b>	00001100 10000110

**Auto Length** – automatic adjustment of the length of the printing code,

**Padding** – manual setting of the length of the code being written. The value 1 is one character.

Example:

the UNIQUE standard the UID code has 5 bytes, HEX format.

Enter **Begin / End (bit)** → 0/39.

Then enter 10 in **Padding**

(from **Begin (bit)** = 0 to **END (bit)** = 39 → 40 bits = 5 bytes (for HEX format it will be 10 characters) → **Padding** = 10).



### 6.7 Reading Mifare block

The reader can read Mifare Classic 1k / 4k memory blocks. One block from the TAG memory can be read. The configuration settings are available in the **Read Block** tab.

Overwrite UID	<input type="radio"/> ON <input type="radio"/> OFF
Authorization KEY type	<input type="radio"/> A <input type="radio"/> B
Block to read	0
KEY	0 0 0 0 0 0

**Overwrite UID** – function that enables block reading. Enabling this option overwrites the UID code with the content of the card,

**Authorization KEY type** – selection of the authentication key (Key A or Key B),

**Block to read** – block number to read,

**KEY** – authentication key, by default it is the key: FFFFFFFF.

## 7 Restore factory settings

---

To restore the factory settings of the device:

1. Run the **RFID Config** program.
2. Connect the device to the computer.
3. In the **RFID Config** application, press the **Reset to DEFAULT** button.
4. The device will be restored to factory settings.

## 8 Firmware update

---

The device has the ability to update the firmware.

**Attention!** Improper use of the update feature may damage the device.

To perform a software update operation, hold the reset button while connecting the module to the computer. The power LED will flash about 4 times per second (the bootloader will be turned on).

Then start the PIC32 Bootloader program (available on the site <https://www.inveo.com.pl>) and follow the steps below:

1. Check **Enable** in USB field and press the **Connect** button.

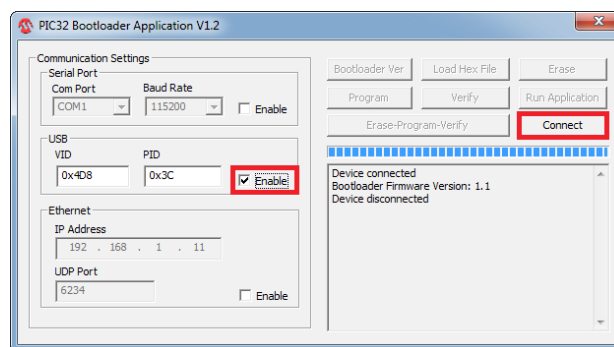

2. Press the **Load Hex File** button, select the update file, and after the file has been loaded, press the **Erase-Program-Verify** button.

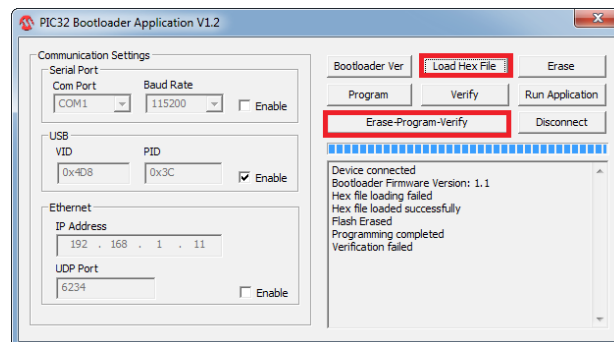

3. The "**Verification failed**" information must be ignored.
4. The last step is to press the Run Application button. The device will indicate that the latest software has been uploaded.

The latest firmware is available at [www.inveo.com.pl](http://www.inveo.com.pl).