

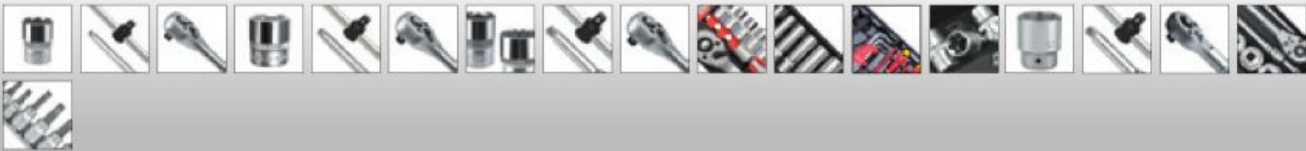









2019

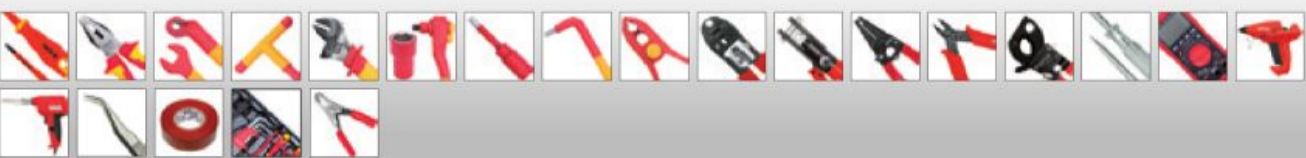

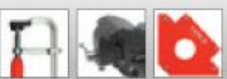
1	SPANNERS / KLUCZE	4-17
		
2	SOCKETS, ACCESSORIES & SETS / KLUCZE NASADOWE, AKCESORIA I ZESTAWY	18-54
		
3	IMPACT SOCKETS, ACCESSORIES & SETS / UDAROWE KLUCZE NASADOWE, AKCESORIA I ZESTAWY	55-63
		
4	TORQUE WRENCHES & TORQUE MULTIPLIERS / KLUCZE DYNAMOMETRYCZNE I WZMACNIACZE MOMENTU	64-69
		
5	SCREWDRIVERS & SCREWDRIVER BITS / WKREŹAKI I KOŃCÓWKI WKREŹAKOWE	70-91
		
6	PLIERS & PIPE WRENCHES / SZCZYPCE I KLUCZE DO RUR	92-107
		
7	ELECTRICIAN TOOLS / NARZĘDZIA DLA ELEKTRYKÓW	108-129
		
8	HAMMERS, CHISELS, PUNCHES & AXES / MŁOTKI, DŁUTA, PRZECINAKI I SIEKIERY	130-139
		
9	CLAMPS, VICES & HOLDERS / ŚCISKI, IMADŁA I WSPORNIKI	140-145
		
10	CUTTING TOOLS / NARZĘDZIA TNĄCE	146-201
		
11	HYDRAULIC TOOLS / NARZĘDZIA HYDRAULICZNE	202-215
		

12	FASTENING TOOLS / NARZĘDZIA DO ŁĄCZENIA	216-231
13	CONSTRUCTION TOOLS / NARZĘDZIA BUDOWLANE	232-253
14	MEASURING TOOLS / NARZĘDZIA MIERNICZE	254-265
15	PNEUMATIC TOOLS / NARZĘDZIA PNEUMATYCZNE	266-285
16	SPECIAL AUTOMOTIVE TOOLS & EQUIPMENT / NARZĘDZIA I WYPOSAŻENIE WARSZTATU SAMOCHODOWEGO	286-389
17	WELDING EQUIPMENT & ACCESSORIES / NARZĘDZIA SPAWALNICZE I AKCESORIA	390-401
18	POWER & GASOLINE TOOLS / ELEKTRONARZĘDZIA I NARZĘDZIA SPALINOWE	402-443
19	ACCESSORIES / AKCESORIA	444-449
20	HEALTH & SAFETY ARTICLES / ARTYKUŁY BHP	450-465
21	ELECTRIC PRODUCTS / ARTYKUŁY ELEKTRYCZNE	466-483
22	GARDEN TOOLS / NARZĘDZIA OGRODNICZE	484-512

1

Spanners Klucze



Combination spanners
Klucze płasko-oczkowe

6-8

Half-moon spanners
Klucze oczkowe typu „C”

13

Combination spanners & sets, polished head
Klucze płasko-oczkowe i zestawy, polerowana główka

6

Flare nut wrenches & sets
Klucze oczkowe półotwarte i zestawy

13

Combination spanners & sets, satin finish
Klucze płasko-oczkowe i zestawy, wykończenie satynowe

7

Stubby combination spanners, polished head
Klucze płasko-oczkowe krótkie, polerowana główka

8

Flexible flare nut wrench sets
Zestawy kluczy oczkowych półotwartych z przegubem

13

Combination ratchet wrenches
Klucze płasko-oczkowe z grzechotką

8-9

Torx ring spanner sets
Zestawy kluczy oczkowych „Torx”

14

Combination ratchet wrenches & sets
Klucze płasko-oczkowe z grzechotką i zestawy

8

Flexible ratchet combination wrenches
Klucze płasko-oczkowe z grzechotką i przegubem

9

L-type socket wrenches
Klucze nasadowe typu „L”

14

Double open end spanners
Klucze płaskie

9-10

Tubular socket wrenches & accessories
Klucze rurowe kute i akcesoria

14

Double open end spanners & sets, polished head
Klucze płaskie i zestawy, polerowana główka

9

Double ratchet spanner sets
Zestawy kluczy oczkowych z grzechotką

10

Double ratchet wrenches
Dwustronne klucze nasadowe z grzechotką

14-15

Bi-hexagonal ring spanners
Klucze oczkowe odgięte

10-11

T-type socket wrenches
Klucze nasadowe typu „T”

15-16

Bi-hexagonal ring spanners & sets, polished head
Klucze oczkowe odgięte i zestawy, polerowana główka

10

Bi-hexagonal ring spanners & sets, satin finish
Klucze oczkowe odgięte i zestawy, wykończenie satynowe

11

Socket wrenches with handle
Klucze nasadowe z rękojeścią

15

T-type deep socket wrenches with rotary handle
Klucze nasadowe typu „T” z obrotową rączką

15

T-type adapters with rotary handle
Adaptory typu „T” z obrotową rączką

15

Insulated T-handle wrenches
Rękojeści typu „T” z zabierakiem izolowane

16

T-type deep socket wrenches
Klucze nasadowe typu „T”

16

T-handle swivel socket wrenches
Klucze nasadowe typu „T” z przegubem

16

Insulated ring & open end wrenches
Klucze oczkowe i płaskie izolowane

11-12

Insulated ring wrenches
Klucze oczkowe izolowane

11

Insulated open end wrenches
Klucze płaskie izolowane

12

Adjustable wrenches
Klucze nastawne

17

Impact wrenches
Klucze do pobijania

12

Flexible hook wrenches
Klucze hakowe

17

Ring impact wrenches
Klucze oczkowe do pobijania

12

Open end impact wrenches
Klucze płaskie do pobijania

12

1

GB Combination spanner
D Maulringschlüssel
PL Klucz płasko-oczkowy
RUS Ключ комбинированный
CZ Plochý a očkový klič
H Kulcs villás-csillag
RO Cheie combinată

F Clé mixte à cliquet
I Chiave combinata
E Combinada con llave de estrella
CN 两用扳手

DIN 3113 CrV AS-DRIVE

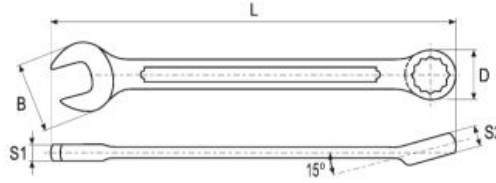

- application: workshop
- head offset: 15°
- surface finish: chromed, satin
- przeznaczenie: warsztat
- kąt odchylenia główek: 15°
- wykończenie powierzchni: chromowana, satynowa



YATO	Ø (mm)	L (mm)	B (mm)	D (mm)	S1 (mm)	S2 (mm)	PCS packing	
YT-0335	6	110	14.8	10.5	3.7	4.9	10	300/600
YT-0336	7	120	16.1	11.3	4.0	5.3	10	300/600
YT-0337	8	130	18.5	12.9	4.2	5.0	10	180/360
YT-0338	9	140	20.5	14.6	4.2	5.0	10	180/360
YT-0339	10	150	22.2	16.2	4.9	6.4	10	180/360
YT-0340	11	160	25.5	17.3	4.9	7.0	10	180/360
YT-0341	12	170	26.7	18.7	5.3	7.6	10	120/240
YT-0342	13	180	28.0	19.6	5.5	8.2	10	120/240
YT-0343	14	190	30.3	21.4	5.9	7.7	10	50/100
YT-0344	15	200	32.8	22.8	6.2	8.5	10	50/100
YT-0345	16	210	33.9	23.7	6.1	9.1	10	50/100
YT-0346	17	220	35.9	24.7	6.5	9.1	10	50/100
YT-0347	18	230	37.8	26.9	6.9	10.0	10	50/100

YATO	Ø (mm)	L (mm)	B (mm)	D (mm)	S1 (mm)	S2 (mm)	PCS packing	
YT-0348	19	235	38.9	27.7	7.0	10.1	10	50/100
YT-0349	20	250	41.4	29.2	7.3	11.0	10	40/80
YT-0350	21	260	43.4	31.0	7.1	10.9	10	40/80
YT-0351	22	270	45.9	32.2	8.1	11.2	5	20/40
YT-0352	23	280	47.8	34.3	7.8	11.1	5	20/40
YT-0353	24	290	49.9	34.8	9.2	11.2	5	20/40
YT-0354	25	300	51.2	36.6	9.2	12.4	5	20/40
YT-0355	26	310	53.2	37.4	9.2	12.9	5	20/40
YT-0356	27	320	55.9	39.3	9.3	12.7	5	15/30
YT-0357	28	330	56.5	40.9	9.9	13.5	5	15/30
YT-0358	29	340	60.0	42.4	10.0	13.6	5	15/30
YT-0359	30	350	60.9	43.8	10.0	14.7	5	10/20
YT-0360	32	370	64.5	46.6	11.3	14.9	5	10/20

GB Combination spanner
D Maulringschlüssel
PL Klucz płasko-oczkowy
RUS Ключ комбинированный
CZ Plochý a očkový klič
H Kulcs villás-csillag
RO Cheie combinată

F Clé mixte à cliquet
I Chiave combinata
E Combinada con llave de estrella
CN 两用扳手

AS-DRIVE

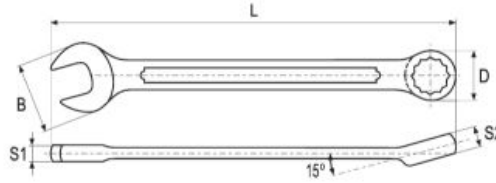

- application: workshop
- head offset: 15°
- surface finish: chromed, satin
- przeznaczenie: warsztat
- kąt odchylenia główek: 15°
- wykończenie powierzchni: chromowana, satynowa



YATO	Ø (mm)	L (mm)	B (mm)	D (mm)	S1 (mm)	S2 (mm)	PCS packing	
YT-00760	34	425	65.2	51.0	13.0	16.0	5	20
YT-00761	36	460	73.0	57.0	14.0	17.5	5	15
YT-00762	38	460	73.0	57.0	14.0	17.5	5	15
YT-00763	41	500	83.0	61.5	15.0	19.0	5	10
YT-00764	46	540	88.3	69.0	16.5	21.0	5	10

YATO	Ø (mm)	L (mm)	B (mm)	D (mm)	S1 (mm)	S2 (mm)	PCS packing	
YT-00765	48	570	92.0	72.0	16.5	22.0	5	10
YT-00766	50	598	96.0	74.0	18.0	23.5	2	8
YT-00767	55	620	105.6	82.4	19.0	25.0	2	6
YT-00768	60	660	115.2	89.8	21.0	27.0	2	6
YT-00769	65	680	124.8	97.3	23.0	29.0	2	4

GB Combination spanner set
D Maulringschlüsselsatz
PL Komplet kluczy płasko-oczkowych
RUS Набор ключей комбинированных

CZ Souprava plochých a očkových kličů
H Kulcskészlet, villás-csillag
RO Set chei combinată
F Set de clés mixtes

I Set chiave combinata
E Juego de combinadas con llave de estrella
CN 两用扳手组套

POUCH & COLOR BOX

DIN 3113 CrV AS-DRIVE



12 PCS 8, 9, 10, 11, 12, 13, 14, 15, 17, 19, 22, 24 mm

17 PCS 8, 9, 10, 11, 12, 13, 14, 15, 16, 17, 18, 19, 22, 24, 27, 30, 32 mm

25 PCS 6, 7, 8, 9, 10, 11, 12, 13, 14, 15, 16, 17, 18, 19, 20, 21, 22, 23, 24, 25, 26, 27, 28, 30, 32 mm

YATO		
YT-0362	6	

YATO		
YT-0363	3	

YATO		
YT-0365	3	

- GB Combination spanner
D Maulringschlüssel
PL Klucz płasko-oczkowy
RUS Ключ комбинированный
CZ Plochý a očkový klíč
H Kulcs villás-csilag
RO Cheie combinată
- F Clé mixte à cliquet
I Chiave combinata
E Combinada con llave de estrella
CN 两用扳手

- DIN 3113
CrV 6140
AS-DRIVE

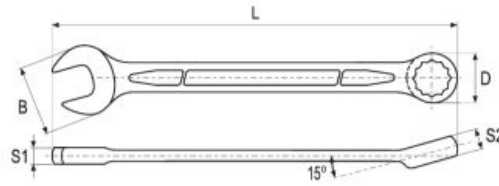

- application: industry
- head offset: 15°
- maximum torque exceeding DIN and ANSI standards by 60%
- surface finish: chromed, satin
- przeznaczenie: przemysł
- kąt odchylenia główki: 15°
- maksymalny moment obrotowy większy o 60% niż w standardach DIN i ANSI
- wykończenie powierzchni: chromowana, satynowa



YATO	Ø (mm)	L (mm)	B (mm)	D (mm)	S1 (mm)	S2 (mm)	PCS packing	
YT-0006	6	109	14.4	10.3	3.7	5.2	10	600
YT-0007	7	119	16.2	11.3	3.8	5.2	10	600
YT-0008	8	129	18.6	12.8	4.2	5.7	10	360
YT-0009	9	139	20.7	14.1	4.3	6.4	10	360
YT-0010	10	149	22.6	15.2	4.8	6.9	10	360
YT-0011	11	159	24.6	16.8	5.2	7.4	10	360
YT-0012	12	169	27.1	18.0	5.3	7.9	10	240
YT-0013	13	179	28.7	19.8	6.0	8.6	10	240
YT-0014	14	189	31.3	20.8	6.2	8.9	10	100
YT-0015	15	199	33.2	22.3	6.6	9.2	10	100
YT-0016	16	209	35.0	23.8	6.8	9.9	10	100
YT-0017	17	219	37.5	25.0	7.0	10.9	10	100
YT-0018	18	229	39.5	26.6	7.8	11.4	10	100
YT-0019	19	239	41.3	28.0	8.0	12.1	10	100
YT-0020	20	249	44.1	29.8	8.3	12.4	10	80
YT-0021	21	259	46.1	30.8	8.6	12.7	10	80

YATO	Ø (mm)	L (mm)	B (mm)	D (mm)	S1 (mm)	S2 (mm)	PCS packing	
YT-0022	22	269	48.2	32.2	9.0	13.1	5	40
YT-0023	23	279	49.8	33.6	9.2	13.4	5	40
YT-0024	24	289	51.4	34.3	9.6	13.4	5	40
YT-0025	25	299	54.6	36.8	9.8	14.2	5	40
YT-0026	26	309	56.2	37.3	10.0	14.9	5	40
YT-0027	27	319	58.7	39.6	10.4	16.4	5	30
YT-0028	28	329	59.4	40.7	10.8	16.9	5	30
YT-0030	30	349	63.0	43.3	11.3	18.4	5	30
YT-0032	32	369	67.3	44.8	11.8	19.4	4	24
YT-0036	36	435	74.0	52.0	13.8	19.6	-	5/10
YT-0038	38	445	76.0	55.0	16.3	20.3	-	5/10
YT-0041	41	475	84.3	60.5	15.8	20.2	-	2/8
YT-0046	46	545	99.3	73.8	17.2	21.8	-	2/8
YT-0050	50	545	99.5	76.0	19.5	22.7	-	2/8
YT-0055	55	610	110.0	80.0	19.5	22.7	-	2/4

- GB Combination spanner set
D Maulringschlüsselsatz
PL Komplet kluczy płasko-oczkowych
RUS Набор ключей комбинированных
- CZ Souprava plochých a očkových klíčů
H Kulcskészlet, villás-csilag
RO Set chei combinate
F Set de clés mixtes
- I Set chiave combinata
E Juego de combinadas con llave de estrella
CN 两用扳手组套



- DIN 3113
CrV 6140

AS-DRIVE



10
PCS
6, 7, 8, 10, 12, 13,
14, 15, 17, 19 mm

YATO
YT-0060
20

12
PCS
8, 9, 10, 11, 12, 13, 14,
15, 17, 19, 22, 24 mm

YATO
YT-0062
6



15
PCS
6, 7, 8, 10, 11, 12, 13, 14, 15,
17, 18, 19, 22, 24, 27 mm

YATO
YT-0065
8

17
PCS
8, 9, 10, 11, 12, 13, 14, 15, 16, 17,
18, 19, 22, 24, 27, 30, 32 mm

YATO
YT-0067
3



25
PCS
6, 7, 8, 9, 10, 11, 12, 13, 14,
15, 16, 17, 18, 19, 20, 21, 22,
23, 24, 25, 26, 27, 28, 30, 32 mm

YATO
YT-0075
3

1

- GB Stubby combination spanner
- D Maulringschlüssel
- PL Klucz płasko-oczkowy krótki
- RUS Ключ комбинированный
- CZ Plochý a očkový klíč
- H Kulcs villás-csillag
- RO Cheie combinată
- F Clé mixte courte
- I Chiave combinata corta
- E Combinada con llave de estrella
- CN 两用扳手



- application: workshop
- head offset: 15°
- surface finish: chromed
- przeznaczenie: warsztat
- kąt odchylenia główki: 15°
- wykończenie powierzchni: chromowana



YATO	Ø (mm)	L (mm)	B (mm)	D (mm)	S1 (mm)	S2 (mm)	PCS packing	
YT-4901	8	91	19.2	13.9	5.0	6.3	10	120/240
YT-4902	9	97	21.7	16.4	5.4	6.4	10	120/240
YT-4903	10	97	21.9	16.6	5.2	6.4	10	120/240
YT-4904	11	100	23.2	18.3	5.9	7.2	10	120/240
YT-4905	12	108	27.4	20.2	6.4	7.6	10	120/240
YT-4906	13	109	27.9	20.7	6.7	7.7	10	120/240

YATO	Ø (mm)	L (mm)	B (mm)	D (mm)	S1 (mm)	S2 (mm)	PCS packing	
YT-4907	14	115	29.3	22.1	6.1	8.3	10	60/120
YT-4908	15	120	31.2	24.0	6.8	9.6	10	60/120
YT-4909	16	121	32.0	24.3	6.8	9.6	10	60/120
YT-4910	17	128	36.6	27.1	7.4	9.9	10	60/120
YT-4911	18	127	36.2	26.8	7.4	9.9	10	60/120
YT-4912	19	135	39.2	29.5	8.8	10.8	10	60/120

- GB Combination ratchet wrench
- D Ratschenringmaulschlüssel
- PL Klucz płasko-oczkowy z grzechotką
- RUS Ключ комбинированный с трещоткой
- CZ Klíč očkoplochý ráčnový
- H Csillag-villás kulcs racsnis

- RO Cheie combinată cu cricchet
- F Clé mixte à cliquet
- I Chiave combinata a cricchetto reversibile

- E Llave combinada fija abierta y carraca
- CN 棘轮两用扳手

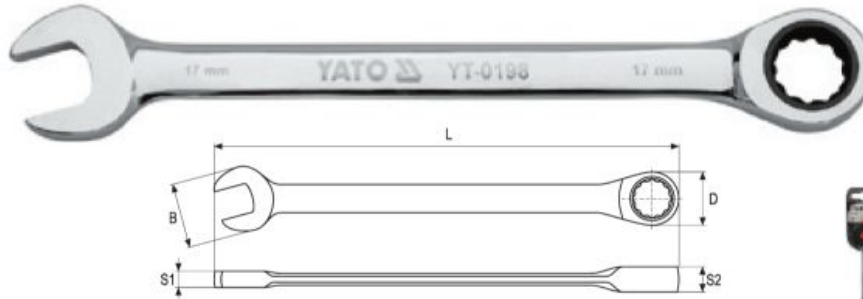

- application: service
- 72 teeth ratchet
- minimum operation angle: 5°
- surface finish: chromed, mirror

- przeznaczenie: serwis
- grzechotka 72 zęby
- minimalny kąt pracy: 5°
- wykończenie powierzchni: chromowana, polerowana



YATO	Ø (mm)	L (mm)	B (mm)	D (mm)	S1 (mm)	S2 (mm)	PCS packing	
YT-01906	6	120	14.7	18.0	4.0	6.5	10	50/100
YT-01907	7	130	16.2	18.0	4.3	7.0	10	50/100
YT-01908	8	141	17.6	18.2	4.8	7.2	10	50/100
YT-01909	9	151	19.4	20.4	4.8	7.4	10	50/100
YT-0191	10	160	22.1	22.2	6.0	7.8	10	50/100
YT-0192	11	165	24.7	24.2	6.6	8.5	10	50/100
YT-0193	12	170	26.4	25.5	6.7	8.9	10	50/100
YT-0194	13	180	27.5	26.7	6.6	9.2	10	50/100
YT-0195	14	190	30.8	29.0	7.4	9.4	10	50/100
YT-0196	15	200	32.9	30.8	7.7	10.1	10	50/100
YT-0197	16	210	34.3	31.5	7.8	10.3	10	50/100

YATO	Ø (mm)	L (mm)	B (mm)	D (mm)	S1 (mm)	S2 (mm)	PCS packing	
YT-0198	17	225	36.8	33.6	8.4	10.6	10	50/100
YT-0199	18	235	39.2	35.6	9.1	10.8	10	50/100
YT-0200	19	245	40.1	37.3	9.5	11.3	10	50/100
YT-0189	21	290	45.2	43.0	9.9	13.3	6	30/60
YT-0201	22	290	45.6	44.2	10.5	13.4	6	24/48
YT-0202	24	335	52.8	50.0	11.3	14.5	6	48
YT-0203	25	335	52.0	47.4	10.2	14.3	6	30
YT-0204	27	355	55.6	52.7	10.9	15.7	6	30
YT-0205	30	400	62.5	57.7	12.2	17.1	6	24
YT-0206	32	420	65.0	61.7	13.2	17.9	6	24

- GB Combination ratchet wrench set
- D Knarrenringmaulschlüssel-satz
- PL Komplet kluczy płasko-oczkowych z grzechotką
- RUS Набор комбинированных ключей с трещоткой
- CZ Klíče ráčnové sada
- H Racsnis csillag-villás kulcs készlet
- RO Set chei combinate
- F Set de clés mixte à cliquet
- I Set chiavi combinate a cricchetto
- E Juego de llaves planas con matraca
- CN 棘轮扳手套



10, 12, 13, 14, 15, 17, 19 mm

YATO	PCS packing
YT-0208	10/20

- GB Combination ratchet wrench
D Ratschenringmaulschlüssel
PL Klucz płasko-oczkowy z grzechotką
RUS Ключ комбинированный с трещоткой
CZ Klíč očkoplochy ráčnový
H Csillag-villás kulcs racsnis
RO Cheie combinata cu crichet
F Clé mixte à cliquet
I Chiave combinata a cricchetto reversibile
E Llave combinada fija abierta y carraca
CN 棘轮两用扳手

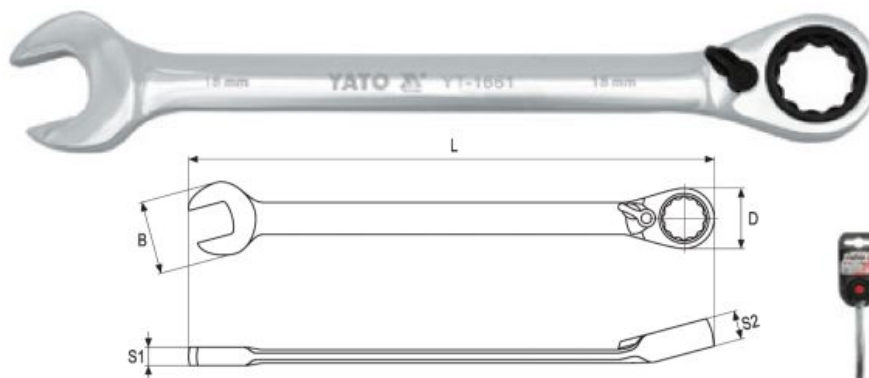

YATO	Ø (mm)	L (mm)	B (mm)	D (mm)	S1 (mm)	S2 (mm)	PCS packing	
YT-1651	8	140	17.5	19.0	6.0	7.2	10	50/100
YT-1652	9	150	19.8	20.7	6.4	7.5	10	50/100
YT-1653	10	160	22.1	23.1	6.4	7.9	10	50/100
YT-1654	11	165	23.9	25.0	6.6	8.4	10	50/100
YT-1655	12	170	27.1	26.0	6.5	8.9	10	50/100
YT-1656	13	180	27.9	27.6	7.1	9.1	10	50/100
YT-1657	14	190	31.6	28.3	7.3	9.5	10	50/100
YT-1658	15	200	32.8	31.4	8.1	9.8	10	50/100
YT-1659	16	210	33.9	32.9	8.4	10.3	10	50/100
YT-1660	17	225	38.0	34.5	8.7	10.5	10	50/100
YT-1661	18	235	39.8	36.9	9.3	10.7	10	50/100

YATO	Ø (mm)	L (mm)	B (mm)	D (mm)	S1 (mm)	S2 (mm)	PCS packing	
YT-1662	19	245	41.8	38.3	9.5	11.3	10	50/100
YT-1663	20	245	41.9	38.1	9.7	11.4	6	30/60
YT-1664	21	290	44.9	43.0	9.8	13.6	6	30/60
YT-1665	22	290	44.8	43.8	10.0	13.6	6	30/60
YT-1666	23	290	44.9	43.3	10.3	13.7	6	24/48
YT-1667	24	330	52.0	49.4	10.2	14.5	6	24/48
YT-1669	26	360	56.3	53.6	12.1	15.7	6	30
YT-1670	27	360	55.6	52.9	12.2	16.1	6	30
YT-1671	28	360	56.1	53.6	12.6	16.0	6	24
YT-1672	30	400	62.1	58.0	11.9	17.2	6	24
YT-1673	32	420	64.1	62.0	12.9	17.7	6	24

- GB Flexible ratchet combination wrench
D Ratschenringmaulschlüssel
PL Klucz płasko-oczkowy z grzechotką i przegubem
RUS Ключ комбинированный с трещоткой
CZ Klíč očkoplochy ráčnový
H Csillag-villás kulcs racsnis
RO Cheie combinata cu crichet
F Clé mixte à cliquet tête articulée
I Chiave combinata a cricchetto testa mobile
E Llave combinada fija abierta y carraca
CN 活头棘轮两用扳手

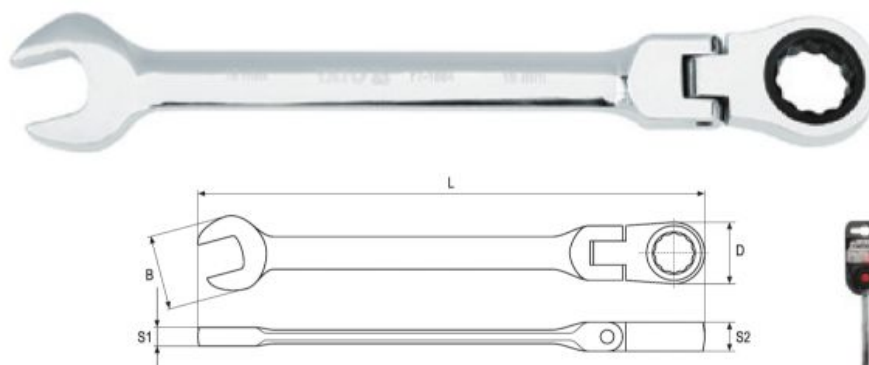

YATO	Ø (mm)	L (mm)	B (mm)	D (mm)	S1 (mm)	S2 (mm)	PCS packing	
YT-1674	8	140	18.0	19.6	6.3	7.3	10	50/100
YT-1675	9	145	19.7	21.1	4.7	7.6	10	50/100
YT-1676	10	160	22.8	23.2	6.3	7.8	10	50/100
YT-1677	11	160	24.0	24.7	5.4	8.5	10	50/100
YT-1678	12	170	26.4	26.7	6.8	8.8	10	50/100
YT-1679	13	180	28.4	27.3	7.2	9.1	10	50/100
YT-1680	14	185	29.5	28.7	6.8	9.4	10	50/100
YT-1681	15	195	32.9	30.8	7.2	9.8	10	50/100

YATO	Ø (mm)	L (mm)	B (mm)	D (mm)	S1 (mm)	S2 (mm)	PCS packing	
YT-1682	16	210	34.4	33.3	7.6	10.3	10	50/100
YT-1683	17	230	36.7	35.7	8.3	10.5	10	50/100
YT-1684	18	235	39.0	35.9	8.0	10.8	10	50/100
YT-1685	19	245	40.8	37.6	9.5	11.2	10	50/100
YT-1686	20	245	40.9	38.2	8.8	11.1	6	30/60
YT-1687	21	290	45.0	42.8	9.8	13.6	6	30/60
YT-1688	22	290	45.2	42.7	9.8	13.5	6	30/60
YT-1690	24	330	51.3	48.7	10.4	14.5	6	24/48

- GB Double open end spanner
D Doppelmaulschlüssel
PL Klucz płaski
RUS Ключ рожковый
CZ Plochy klíč
H Villáskulcs
RO Cheie fixă
F Clé plate
I Chiave piatta
E Llave fija
CN 双头呆扳手



- surface finish: chromed, satin / mirror
- wykończenie powierzchni: chromowana, satynowa / polerowana

YATO	Ø (mm)	L (mm)	B (mm)	D (mm)	S1 (mm)	S2 (mm)	PCS packing	
YT-0367	6x7	120	15.1	16.8	3.5	3.6	10	360/720
YT-0368	8x9	140	18.7	20.8	3.7	3.6	10	180/360
YT-0369	10x11	155	22.4	25.5	4.6	4.6	10	150/300
YT-0332	10x13	170	22.5	29.3	4.6	5.3	10	150/300
YT-0370	12x13	170	27.1	29.3	4.9	5.3	10	80/160
YT-0333	13x17	180	29.3	37.5	5.3	6.3	10	50/100
YT-0371	14x15	180	31.0	33.0	5.3	5.4	10	80/160
YT-0372	16x17	200	34.9	37.5	6.5	6.3	10	50/100

YATO	Ø (mm)	L (mm)	B (mm)	D (mm)	S1 (mm)	S2 (mm)	PCS packing	
YT-0334	17x19	220	37.5	38.7	6.3	6.3	10	50/100
YT-0373	18x19	220	38.7	41.0	6.6	6.3	10	50/100
YT-0374	20x22	230	42.1	46.8	7.1	6.8	10	30/60
YT-0375	21x23	245	44.4	48.6	7.3	6.9	10	30/60
YT-0376	24x27	260	51.6	56.9	8.1	8.1	5	20/40
YT-0377	25x28	270	52.3	57.9	8.4	8.3	5	20/40
YT-0378	30x32	295	61.4	65.1	8.0	8.6	5	15/30

1

GB Double open end spanner set
D Doppelmaulschlüsselsatz
PL Komplet kluczy płaskich
RUS Набор рожковых ключей

CZ Souprava plochých klíčů
H Kulcskészlet, villás
RO Set chei fixe
F Set de clés à tête fendue

I Set di chiavi piatte
E Juego de llaves fijas
CN 双头呆扳手组套

POUCH & COLOR BOX



DIN 3110

CrV



10 PCS
6x7, 8x9, 10x11, 12x13, 14x15, 16x17, 18x19, 20x22, 21x23, 24x27 mm

YATO
YT-0380 6

12 PCS
6x7, 8x9, 10x11, 12x13, 14x15, 16x17, 18x19, 20x22, 21x23, 24x27, 25x28, 30x32 mm

YATO
YT-0381 8

GB Double ratchet spanner set
D Ringschlüsselsatz
PL Klucze oczkowe z grzechotką
RUS Набор ключей накидных
CZ Očkové klíče
H Csillagkulcs készlet
RO Set chei inelare
F Set de clés à œil à cliquet
I Set chiavi a cricchetto
E Llaves de anillo
CN 双头梅花棘轮扳手组套



5 PCS
MICHELETTI
CrV 6140
72T

PLASTIC HANGER



8x9, 10x11, 12x13, 14x15, 17x19 mm

YATO
YT-5038 10/30

GB Bi-hexagonal ring spanner
D Doppelringschlüssel
PL Klucz oczkowy odgięty
RUS Ключ накидной изогнутый
CZ Očkový klíč ohnutý
H Hajlítottszerű csillagkulcs
RO Cheie inelaro-curbată
F Clé contre-coudée
I Chiave poligonale doppio piegato
E Llave de estrella
CN 双头高颈梅花扳手



DIN 838
CrV
AS-DRIVE

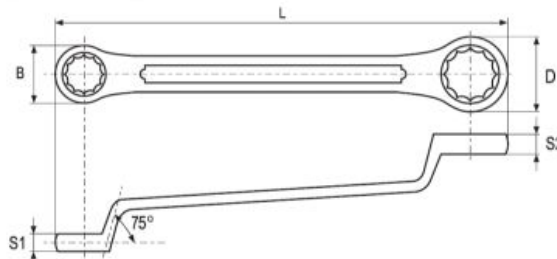

- application: industry
- surface finish: chromed, satin / mirror
- przeznaczenie: przemysł
- wykończenie powierzchni: chromowana, satynowa / polerowana



COLOR BOX

YATO	Ø (mm)	L (mm)	B (mm)	D (mm)	S1 (mm)	S2 (mm)	PCS packing	Box
YT-0383	6x7	165	11.0	12.7	5.4	5.5	10	200/400
YT-0384	8x9	185	13.9	15.5	6.8	7.2	10	100/200
YT-0385	10x11	200	16.3	17.6	6.8	7.2	10	100/200
YT-0386	12x13	220	19.6	21.5	7.2	7.7	10	60/120
YT-0387	14x15	230	23.6	21.9	8.9	9.1	10	50/100
YT-0388	16x17	255	24.6	26.4	8.6	9.3	10	30/60

YATO	Ø (mm)	L (mm)	B (mm)	D (mm)	S1 (mm)	S2 (mm)	PCS packing	Box
YT-0389	18x19	270	27.5	28.8	10.5	10.2	5	25/50
YT-0390	20x22	290	30.9	33.4	10.5	11.4	5	20/40
YT-0391	21x23	310	31.9	34.4	11.8	12.4	5	20/40
YT-0392	24x27	330	36.2	40.6	11.5	13.2	5	20/40
YT-0394	30x32	390	44.0	47.1	13.8	14.9	3	15/30

GB Bi-hexagonal ring spanner set
D Doppelringschlüsselsatz
PL Komplet kluczy oczkowych odgiętych
RUS Набор ключей накидных изогнутых

CZ Klíče očkové vyhnuté sada
H Csillagkulcs készlet
RO Set chei inelare cu cot
F Set de clés contre-coudées

I Set chiavi poligonali doppie piegate
E Juego de llaves de estrella acodadas
CN 双头高颈梅花扳手组套

POUCH & COLOR BOX



DIN 838

CrV

AS-DRIVE



8 PCS
6x7, 8x9, 10x11, 12x13, 14x15, 16x17, 18x19, 20x22 mm

YATO
YT-0396 6

12 PCS
6x7, 8x9, 10x11, 12x13, 14x15, 16x17, 18x19, 20x22, 21x23, 24x27, 25x28, 30x32 mm

YATO
YT-0398 4

- GB Bi-hexagonal ring spanner
- D Doppelringschlüssel
- PL Klucz oczkowy odgięty
- RUS Ключ накидной изогнутый
- CZ Očkový klíč ohnutý
- H Hajlítottszerű csillagkulcs
- RO Cheie inelaro-curbată
- F Clé contre-coudée
- I Chiave poligonale doppio piegato
- E Llave de estrella
- CN 双头高颈梅花扳手

- application: industry
- surface finish: chromed, satin
- przeznaczenie: przemysł
- wykończenie powierzchni: chromowana, satynowa

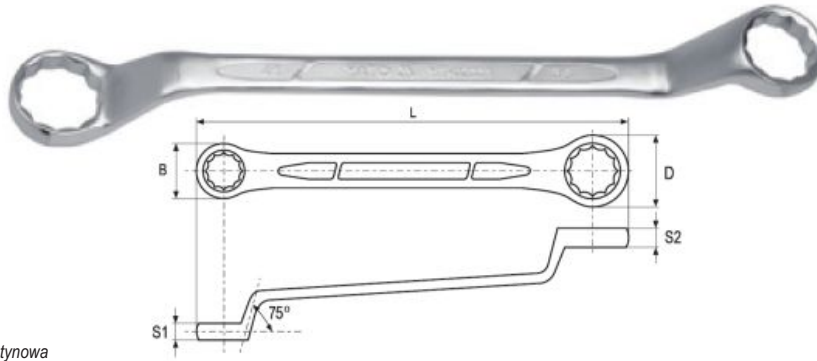

COLOR BOX



YATO	Ø (mm)	L (mm)	B (mm)	D (mm)	S1 (mm)	S2 (mm)	PCS packing	
YT-02330	32x36	408	52	46	17.5	17.5	5	20
YT-02331	36x41	448	58	52	18.0	18.0	5	20
YT-02332	41x46	483	65	58	18.5	18.5	5	15

YATO	Ø (mm)	L (mm)	B (mm)	D (mm)	S1 (mm)	S2 (mm)	PCS packing	
YT-02333	46x50	495	71	65	19.0	19.0	5	10
YT-02334	50x55	538	78	71	19.5	19.5	5	10

- GB Bi-hexagonal ring spanner
- D Doppelringschlüssel
- PL Klucz oczkowy odgięty
- RUS Ключ накидной изогнутый
- CZ Očkový klíč ohnutý
- H Hajlítottszerű csillagkulcs
- RO Cheie inelaro-curbată
- F Clé contre-coudée
- I Chiave poligonale doppio piegato
- E Llave de estrella
- CN 双头高颈梅花扳手

- application: industry
- maximum torque exceeding DIN and ANSI standards by 60%
- surface finish: chromed, satin

- przeznaczenie: przemysł
- maksymalny moment obrotowy większy o 60% niż w standardach DIN i ANSI
- wykończenie powierzchni: chromowana, satynowa

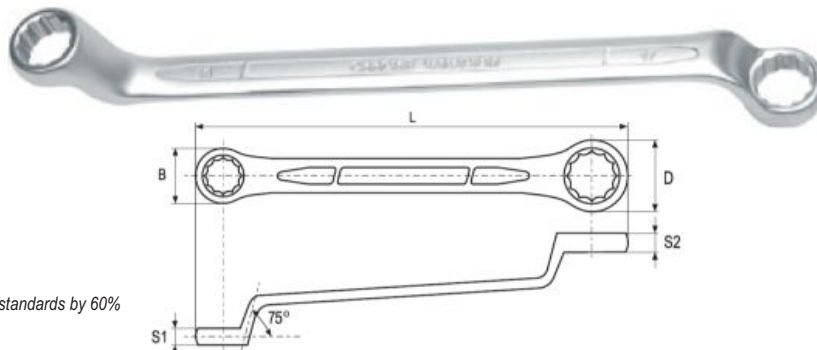

DIN 838

CrV 6140

AS-DRIVE

COLOR BOX



YATO	Ø (mm)	L (mm)	B (mm)	D (mm)	S1 (mm)	S2 (mm)	PCS packing	
YT-0209	8x9	183	13.3	14.8	6.7	7.2	10	160
YT-0211	10x11	198	16.3	17.7	7.7	8.8	10	100
YT-0213	12x13	217	19.2	20.6	8.7	9.2	10	100
YT-0215	14x15	239	22.1	23.4	9.6	10.1	5	50
YT-0217	16x17	260	25.0	26.4	10.6	10.9	5	60
YT-0219	18x19	292	27.9	29.4	11.2	11.5	5	60

YATO	Ø (mm)	L (mm)	B (mm)	D (mm)	S1 (mm)	S2 (mm)	PCS packing	
YT-0222	20x22	318	30.8	33.7	11.8	12.5	5	30
YT-0223	21x23	326	32.3	35.2	12.1	12.8	5	30
YT-0227	24x27	329	36.6	40.7	13.1	14.0	5	30
YT-0228	25x28	347	38.1	42.5	14.0	14.3	2	16
YT-0232	30x32	362	45.2	49.2	15.0	15.7	2	16

- GB Bi-hexagonal ring spanner set
- D Doppelringschlüsselsatz
- PL Komplet kluczy oczkowych odgiętych
- RUS Набор ключей накидных изогнутых
- CZ Klíče očkové vyhnuté sada
- H Csillagkulcs készlet
- RO Set chei inelare cu cot
- F Set de clés contre-coudées
- I Set chiavi poligonali doppie piegate
- E Juego de llaves de estrella acodadas
- CN 双头高颈梅花扳手手套



POUCH & COLOR BOX



DIN 838

CrV 6140

AS-DRIVE

10 PCS

6x7, 8x9, 10x11, 12x13, 14x15, 16x17, 18x19, 20x22, 21x23, 24x27 mm

YATO

YT-0250

10

- GB Insulated ring wrench
- D Einringschlüssel vollisoliert
- PL Klucz oczkowy odgięty izolowany
- RUS Ключ накидной односторонний изолированный
- CZ Očkový klíč, izolovaný
- H Hajlítottszerű csillagkulcs
- RO Cheie inelara izolata
- F Clé polygonale coudée isolée
- I Chiave poligonale piegato isolato
- E Llave de estrella acodada aislante
- CN 绝缘梅花扳手

1000V
VDE CERTIFICATE
EN 60900:2012

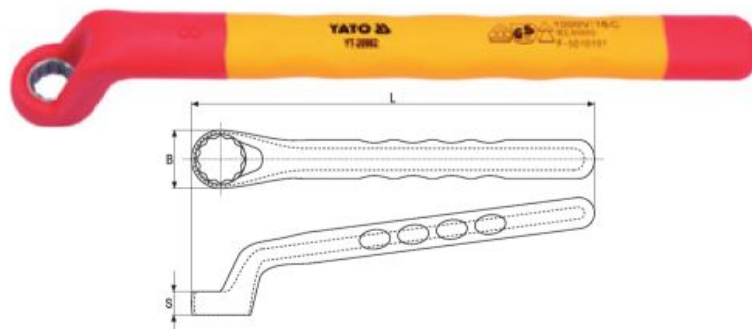

CrV

1000 V

DVE

POLYBAG



YATO	Ø (mm)	L (mm)	B (mm)	S (mm)	
YT-20980	6	150	16.0	5.5	6/126
YT-20981	7	150	18.0	5.7	6/126
YT-20982	8	155	19.0	6.1	6/126
YT-20983	9	155	20.0	7.2	6/126
YT-20984	10	170	21.0	7.3	6/90
YT-20985	11	170	22.5	7.7	6/90
YT-20986	12	190	22.5	8.5	6/90
YT-20987	13	190	26.5	9.0	6/90
YT-20988	14	205	28.0	9.5	6/90
YT-20989	15	205	29.0	9.5	6/90

YATO	Ø (mm)	L (mm)	B (mm)	S (mm)	
YT-20990	16	215	31.0	10.2	6/90
YT-20991	17	215	32.0	10.7	6/90
YT-20992	18	230	35.0	11.5	6/90
YT-20993	19	230	36.0	12.0	6/90
YT-20994	21	245	39.0	13.0	6/48
YT-20995	22	245	41.0	12.2	6/48
YT-20996	24	265	44.0	13.0	6/48
YT-20997	27	290	48.0	14.5	4/40
YT-20998	30	310	52.0	15.2	4/40
YT-20999	32	310	55.0	16.5	4/40

GB Insulated open end wrench
 D Doppelmaulschlüssel isoliert
 PL Klucz płaski izolowany
 RUS Ключ рожковый односторонний изолированный

CZ Otevřený klíč, izolovaný
 H Villáskulcs
 RO Cheie fixă izolată
 F Clé plate isolée

I Chiave piatta isolato
 E Llave fija aislante
 CN 绝缘开口扳手

POLYBAG

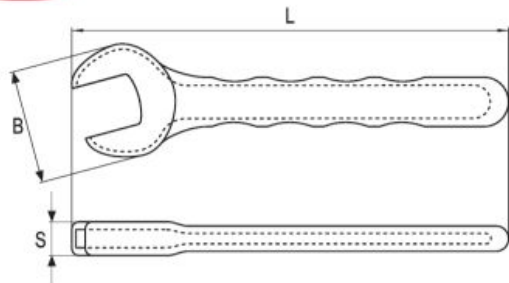

1000V
 VDE CERTIFICATE
 EN 60900:2012

YATO	Ø (mm)	L (mm)	B (mm)	S (mm)	
YT-20950	6	90	23	7.0	6/108
YT-20951	7	90	25	7.0	6/108
YT-20952	8	100	27	7.5	6/108
YT-20953	9	100	29	7.5	6/108
YT-20954	10	110	31	8.0	6/108
YT-20955	11	110	34	8.5	6/108
YT-20956	12	130	36	8.5	6/108
YT-20957	13	135	39	10.5	6/108
YT-20958	14	145	40	10.5	6/72
YT-20959	15	150	42	11.5	6/72
YT-20960	16	160	43	11.5	6/72
YT-20961	17	160	47	12.5	6/72
YT-20962	18	175	50	13.0	6/72
YT-20963	19	175	53	14.0	6/72
YT-20964	21	195	55	14.0	6/66
YT-20965	22	195	58	14.0	6/66
YT-20966	24	225	62	16.5	6/66
YT-20967	27	250	69	18.0	4/60
YT-20968	30	290	75	19.0	4/48
YT-20969	32	310	79	20.0	4/48

GB Ring impact wrench
 D Schlagringschlüssel
 PL Klucz do pobijania ockowy
 RUS Ключ закрытый для растряски
 CZ Klíč maticový ockový rázový
 H Útőcsillagkulcs
 RO Cheie inelară cu bătător
 F Clé à frapper à œil
 I Chiave poligonale semplice a percussione
 E Llave de muletilla para usarse dando golpes
 CN 敲击梅花扳手

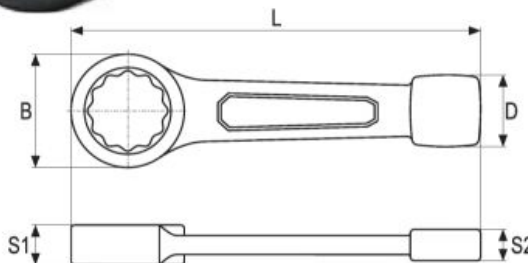

- application: industry
- 12 point profile
- AS-DRIVE system
- drop forged
- surface finish: black oxidised
- przeznaczenie: przemysł
- profil 12-kątny
- system AS-DRIVE
- kute
- wykończenie powierzchni: czarna, oksydowana

YATO	Ø (mm)	L (mm)	B (mm)	D (mm)	S1 (mm)	S2 (mm)	
YT-1601	24	160	41	31	15.0	10	5/25
YT-1602	27	185	47	33	15.0	12	5/25
YT-1603	30	190	51	35	16.5	14	5/25
YT-1604	32	195	54	37	16.5	15	5/25
YT-1605	36	210	60	39	20.0	17	5/10
YT-1606	38	210	60	39	20.0	17	5/10
YT-1607	41	225	66	42	20.0	18	5/10

YATO	Ø (mm)	L (mm)	B (mm)	D (mm)	S1 (mm)	S2 (mm)	
YT-1608	46	240	74	44	22.0	19	5/10
YT-1609	50	250	80	45	23.0	20	5/10
YT-1610	55	270	86	55	25.0	22	5/10
YT-1611	58	270	86	55	25.0	22	5
YT-1612	60	270	92	60	25.0	23	5
YT-1613	65	290	100	65	30.0	24	5
YT-1614	70	310	108	70	32.0	25	5

GB Open end impact wrench
 D Schlagschraubenschlüssel
 PL Klucz do pobijania płaski
 RUS Ключ плоский для растряски
 CZ Klíč maticový plochý rázový
 H Útőlapkulcs
 RO Cheie fixă cu bătător
 F Clé à frapper plate
 I Chiave a forchetta semplice a percussione
 E Llave de boca abierta para usarse dando golpes
 CN 敲击开口扳手

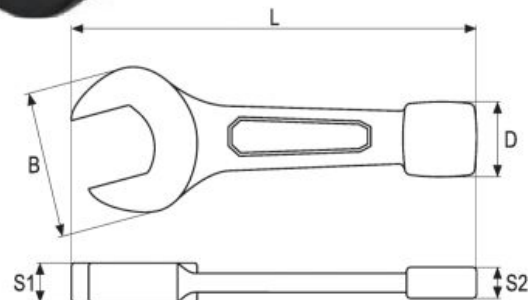

- application: industry
- head offset: 15°
- drop forged
- surface finish: black oxidised
- przeznaczenie: przemysł
- kąt odchylenia główki: 15°
- kute
- wykończenie powierzchni: czarna, oksydowana

YATO	Ø (mm)	L (mm)	B (mm)	D (mm)	S1 (mm)	S2 (mm)	
YT-1615	27	180	55	33	15	12	5/25
YT-1616	30	187	63	35	17	14	5/25
YT-1617	32	195	67	37	18	15	5/25
YT-1618	36	210	77	39	18	17	5/10

YATO	Ø (mm)	L (mm)	B (mm)	D (mm)	S1 (mm)	S2 (mm)	
YT-1619	41	225	89	42	20	18	5/10
YT-1620	46	255	98	44	20	19	5/10
YT-1621	50	280	107	45	22	20	5
YT-1622	55	310	118	55	25	22	5

- GB Half-moon spanner
- D Starter- und Blockschlüssel
- PL Klucz oczkowy typu „C”
- RUS Ключ накладной изогнутый „C”
- CZ Klíč očkoplochy typ „C”
- H Félhold alakú csillagkulcs
- RO Cheie inelara semi-luna
- F Clé à œil „C”
- I Chiave poligonale doppio speciale tipo „C”
- E Llave de estrella tipo „C”
- CN C型梅花扳手

- application: industry
- excellent for work in tight spaces
- used for dismantling of collector tubes, alternators and starters
- surface finish: chromed, satin
- przeznaczenie: przemysł
- do pracy w miejscach szczególnie trudnodostępnych
- ułatwia odkręcanie kolektorów, alternatorów i rozruszników samochodowych
- wykończenie powierzchni: chromowana, satynowa

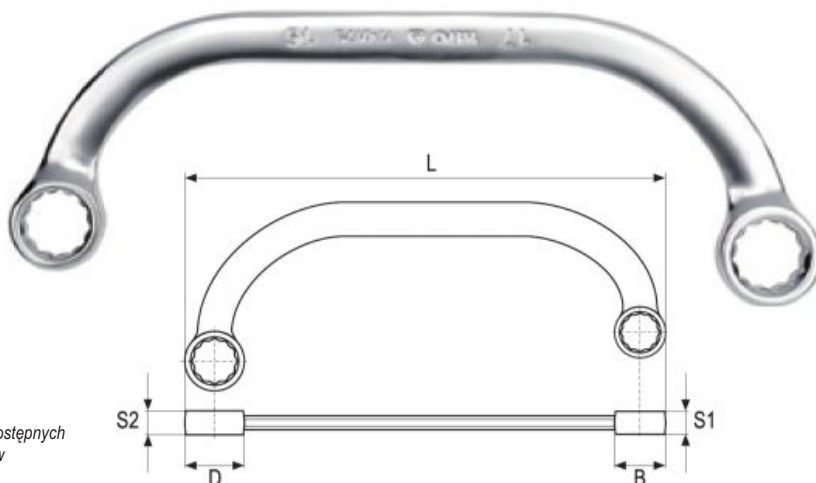

CrV 6140 AS-DRIVE

YATO	Ø (mm)	L (mm)	B (mm)	D (mm)	S1 (mm)	S2 (mm)	PCS
YT-0170	10x12	145	16.8	19.2	6.8	6.8	10/60
YT-0171	11x13	170	18.5	21.2	8.4	8.6	10/60
YT-0172	14x15	195	22.8	25.8	9.2	9.9	10/60

YATO	Ø (mm)	L (mm)	B (mm)	D (mm)	S1 (mm)	S2 (mm)	PCS
YT-0173	16x17	220	26.2	28.6	9.9	10.5	10/60
YT-0175	19x22	260	28.7	32.9	10.4	10.9	10/60

- GB Flare nut wrench
- D Schraubenschlüssel, halboffen
- PL Klucz oczkowy półotwarty
- RUS Ключ накладной полуоткрытый
- CZ Klíč prstencový polootevřený
- H Csuklós, nyitott
- RO Cheie inelară semideschisă
- F Clé mixte à cliquet
- I Chiave poligonale semiaperta
- E Llave semiabierta
- CN 油管扳手

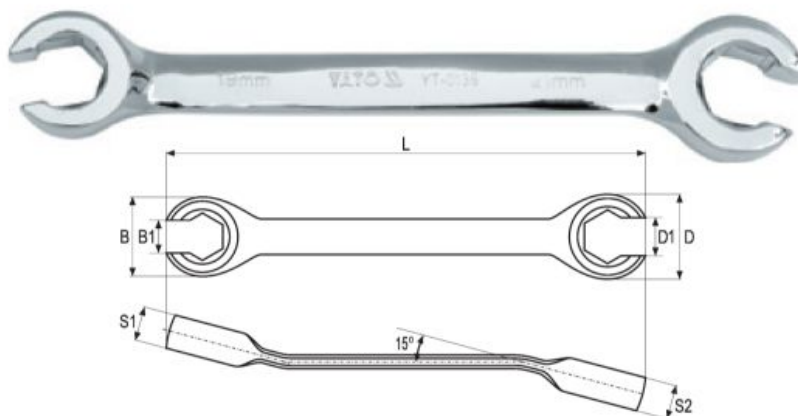

CrV 6140

YATO	Ø (mm)	L (mm)	B (mm)	D (mm)	B1 (mm)	D1 (mm)	S1 (mm)	S2 (mm)	PCS
YT-0135	8x10	140	18.7	21.8	6.2	7.2	7.7	8.4	10
YT-0136	11x12	160	21.2	24.0	8.1	9.2	8.5	9.5	10
YT-0137	13x14	175	26.3	27.3	9.6	10.7	9.6	10.5	10
YT-0138	15x17	190	31.2	31.2	11.8	13.0	11.5	10.9	10

YATO	Ø (mm)	L (mm)	B (mm)	D (mm)	B1 (mm)	D1 (mm)	S1 (mm)	S2 (mm)	PCS
YT-01385	17x19	195	29.0	31.2	14.5	15.0	12.4	12.8	10
YT-0139	19x21	230	36.3	42.1	14.7	16.7	12.4	12.8	10
YT-0140	22x24	250	42.7	44.2	17.1	18.6	13.2	13.9	10

COLOR BOX



- GB Flare nut wrench set
- D Schraubenschlüssel, halboffen
- PL Zestaw kluczy oczkowych półotwartych
- RUS Ключ накладной полуоткрытый
- CZ Klíč prstencový polootevřený
- H Csuklós, nyitott
- RO Cheie inelară semideschisă
- F Set de clés à tête fendue
- I Set chiavi poligonali semiaperte
- E Llave semiabierta
- CN 油管扳手套

4 PCS
CrV 6140



YATO
YT-0143 25/50

8x10, 11x12, 13x14, 15x17 mm

- GB Flexible flare nut wrench set
- D Schraubenschlüssel, halboffen mit Gelenk
- PL Komplet kluczy oczkowych półotwartych z przegubem
- RUS Ключ накладной полуоткрытый с шарниром
- CZ Klíč prstencový polootevřený s kloubem
- H Csuklós, nyitott csillagkulcs
- RO Cheie inelară semideschisă, cu articulație
- F Set de clés à tête fendue articulée

- I Set chiavi poligonali a due bocche aperte con testa snodata
- E Llave semiabierta con una junta
- CN 活头油管扳手套

7 PCS
CrV 6140 AS-DRIVE



PLASTIC HANGER

YATO
YT-0190 5/20

8, 10, 11, 12, 13, 14, 17 mm

1

- GB Torx ring spanner set
 D Torx-Ringschlüsselsatz
 PL Komplet kluczy oczkowych Torx
 RUS Набор накидных ключей
 CZ Očkové klíče
 H Csillagkulcs készlet
 RO Chei inelare
 F Set de clés à œil
- I Set chiavi doppie Torx
 E Llaves de anillo Torx
 CN 星型扳手组套



E6xE8, E10xE12, E14xE18, E20xE24

4 PCS TORX CrV 6150

SLIDING CARD



YATO
 YT-0530

10/60

- GB L-type socket wrench
 D Steckschlüssel gebogen
 PL Klucz nasadowy typu „L”
 RUS Ключ торцевой „L” типа
- CZ Nástrčný kľúč fajtkový
 H Kulcs, dugó-pipa
 RO Cheie tubulara cu cot tip „L”
 F Clé à pipe en „L”
- I Chiave a tubo doppio tipo „L”
 E Llave de vaso „L”
 CN L 型套筒扳手

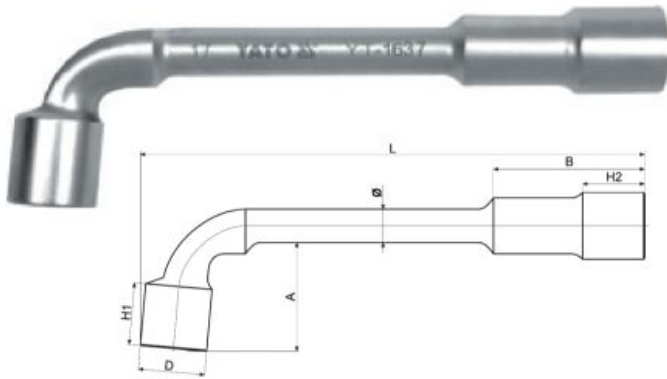

YATO	Ø (mm)	L (mm)	B (mm)	H1 (mm)	H2 (mm)	A (mm)	D (mm)	Ø (mm)	
YT-1627	7	106	27.0	10.2	10.1	21.0	10.7	7	12/60
YT-1628	8	117	29.5	12.3	11.9	18.5	12.2	9	12/60
YT-1629	9	121	31.7	13.4	12.8	19.1	13.2	10	12/60
YT-1630	10	131	35.1	16.4	16.9	23.3	15.0	10	12/60
YT-1631	11	138	36.0	16.5	16.8	24.7	16.3	11	12/60
YT-1632	12	147	42.5	17.9	18.2	17.9	18.0	12	12/60
YT-1633	13	154	44.2	18.5	19.1	30.1	19.3	12	12/60
YT-1634	14	162	47.0	19.3	20.3	30.2	20.8	13	12/60
YT-1635	15	173	48.9	20.6	21.6	31.6	22.3	13	12/60
YT-1636	16	182	55.0	23.2	23.1	37.3	23.6	14	12/60
YT-1637	17	188	57.0	25.1	25.5	37.9	25.1	14	12/36
YT-1638	18	192	57.1	25.1	24.6	40.1	26.0	14	12/36
YT-1639	19	207	62.3	26.9	27.4	41.6	28.2	16	12/36
YT-1640	20	215	62.4	27.0	28.3	42.4	29.2	16	6/24
YT-1641	21	221	65.0	30.5	30.6	54.0	30.2	16	6/24
YT-1642	22	232	67.5	30.8	30.6	49.1	31.7	16	6/24
YT-1644	24	253	78.2	32.3	31.7	53.5	33.6	17	6/18
YT-1647	27	288	85.3	36.9	36.4	54.7	37.6	20	6/12
YT-1649	30	310	95.0	38.4	38.6	65.3	42.0	22	6/12
YT-1650	32	339	99.2	40.4	40.5	66.8	43.8	22	6

CrV 6140

- GB Heavy duty tubular socket wrench
 D Rohrsteckschlüsselsatz
 PL Klucz rurowy kuty
 RUS Ключ двухлучевой с головками
 CZ Klíče trubkové
 H Csőkulcs
 RO Cheie pt. țevi
 F Clé à tube double droite
 I Chiave a tubo
 E Llave de tuberia
 CN 小轮胎扳手



CrV 40 AS-DRIVE

COLOR BOX



YATO	Ø (mm)	D1 (mm)	D2 (mm)	D (mm)	L (mm)	PCS packing	
YT-4915	8x9	13	14	3	110	10	60/240
YT-4916	10x11	15	16	5	120	10	60/240
YT-4917	12x13	18	19	6	140	10	60/120
YT-4918	14x15	20	22	6	145	10	60/120
YT-4919	16x17	23	24	7	155	10	60/120
YT-4920	18x19	25	26	8	165	5	40/80

YATO	Ø (mm)	D1 (mm)	D2 (mm)	D (mm)	L (mm)	PCS packing	
YT-4921	20x22	28	30	8	170	5	30/60
YT-4922	21x23	29	31	10	185	5	30/60
YT-4923	24x26	33	35	12	190	5	40
YT-4925	27x29	37	39	12	210	5	40
YT-4926	30x32	40	42	13	210	5	20

- GB Tubular socket wrench handle
 D Stellstab für Rohrschlüssel
 PL Pokręto do kluczy rurowych
 RUS Вороток к трубчатым ключам
- CZ Tyčka k trubkovým klíčům
 H Forgalókar dugókulcshoz
 RO Clupă pt. chei tubulare
 F Support de clés à tube
- I Spina di manovra per chiave a tubo doppia
 E Mango para las llaves de tubo
 CN 旋棒

COLOR BOX



CrV 40



YATO	L (mm)	mm	PCS packing	
YT-4927	190	2.5; 4.5; 5.5	50	150
YT-4928	280	6.5; 7.5; 9.5; 11.5; 12.5	50	100

- GB Ratchet wrench
 D Gerüstratsche
 PL Klucz nasadowy z grzechotką
 RUS Ключ торцовый с трещоткой
 CZ Ráčnový kľúč prúchozí
 H Kettős racsnis kulcs
 RO Cheie tubulara cu clichet
 F Clé à tube à cliquet
 I Chiavi a cricchetto per ponteggi
 E Llave de vaso con carraca
 CN 尖尾棘轮扳手



PLASTIC HANGER



CrV 32T

COLD FORGED KUTE NA ZIMNO

YATO	Ø (mm)	L (mm)	
YT-4937	19x22	315	2/40



- GB Double ratchet wrench
- D Gerüstratsche
- PL Dwustronny klucz nasadowy z grzechotką
- RUS Ключ торцовый с трещоткой
- CZ Ráčnový klíč průchozí dvoustranný
- H Kettős racsnis kulcs
- RO Cheie tubulara dubla cu clichet
- F Clé à œil à cliquet
- I Chiave a cricco doppio
- E Llave de vaso con carraca
- CN 尖尾棘轮扳手

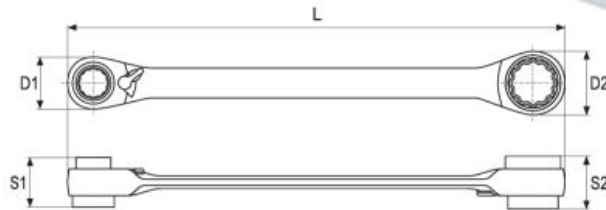

DOUBLE BLISTER



YATO	Ø (mm)	L (mm)	D1 (mm)	D2 (mm)	S1 (mm)	S2 (mm)	
YT-4945	10x13x17x19	200	29	35	17	22	5/50

- GB Socket wrench with handle
- D Steckschlüssel
- PL Klucz nasadowy z rączką
- RUS Ключ торцевой
- CZ Nástrčný klíč
- H Kulcs
- RO Cheie tubulara

- F Clé à tube
- I Chiave a cricco doppio
- E Llave
- CN 六角套筒螺丝批

COLOR BOX

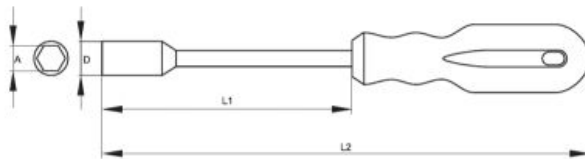

YATO	Ø (mm)	D (mm)	L1 (mm)	L2 (mm)	PCS packing	
YT-1541	5	8.0	125	242	6	120
YT-1542	6	9.1	125	242	6	120
YT-1543	7	10.9	125	242	6	120
YT-1544	8	12.0	125	242	6	120
YT-1545	9	13.0	125	242	6	120
YT-1546	10	14.1	125	242	6	120
YT-1547	11	15.9	125	242	6	120
YT-1548	12	16.9	125	242	6	120
YT-1549	13	18.0	125	242	6	120

- GB T-type deep socket wrench with rotary handle
- D Steckschlüssel vom Typ „T“ mit drehbarem Handgriff
- PL Klucz nasadowy typu „T“ z obrotową rękojeścią
- RUS Торцовый ключ типа „Т“ с вращательной ручкой
- CZ Klíč nástrčný typ „T“ s otočnou rukojetí
- H „T“ típusú dugókulcs, forgatható karral
- RO Cheie tubulară de tip „T” cu mâner rotativ
- F Clé à tube
- I Chiave tipo „T” con manico scorrevole
- E Llave tubular „T” con un mango giratorio
- CN T型套筒扳手



COLOR CARDBOARD

- GB T-type adapter with rotary handle
- D Adapter vom Typ „T” mit drehbarem Handgriff
- PL Adapter typu „T” z obrotową rękojeścią
- RUS Адаптер типа „Т” с вращательной ручкой
- CZ Adaptér typ „T” s otočnou rukojetí
- H „T” típusú adapter, forgatható karral
- RO Adaptor tip „T” cu mâner rotativ
- F Adapteur
- I Adattatore tipo „T” con manico scorrevole
- E Adaptador „T” con un mango giratorio
- CN T型套筒扳手

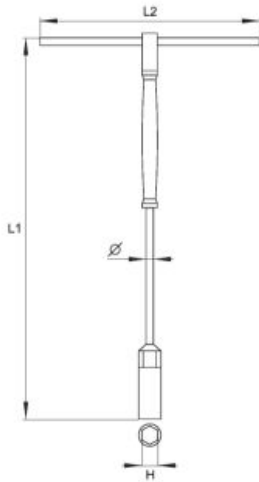
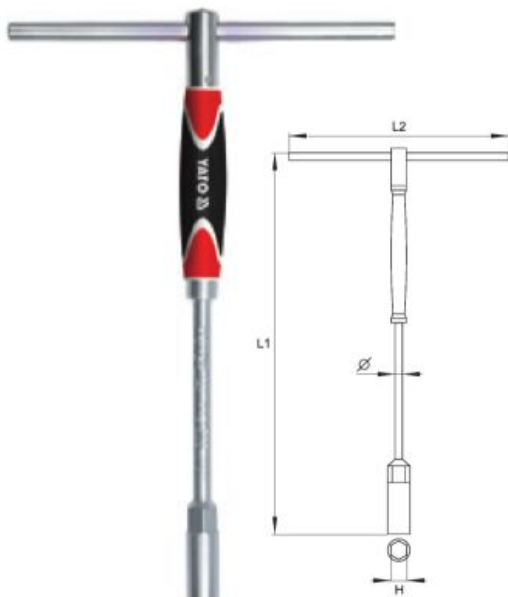
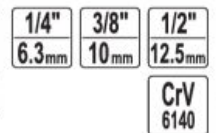

- ergonomic handle
- movable handle with position locking system
- long bar for work in deeply set, difficult to reach places

- ergonomiczna rękojeść
- przesuwane pokrętko z blokadą położenia
- długi trzpień umożliwiający pracę w głębokich wnękach

YATO	Ø H	L1 (mm)	L2 (mm)	Ø (mm)	
YT-1552	8 mm	310	200	10	10/40
YT-1553	9 mm	310	200	10	10/40
YT-1554	10 mm	310	200	10	10/40
YT-1555	11 mm	310	200	10	10/40
YT-1556	12 mm	310	200	10	10/40
YT-1557	13 mm	310	200	10	10/40
YT-1558	14 mm	310	200	10	10/40
YT-1559	15 mm	310	200	10	10/40

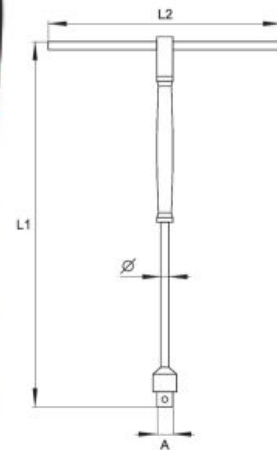
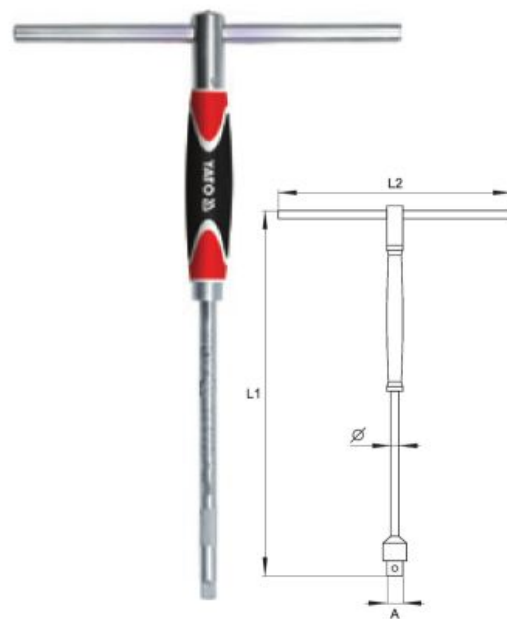

- ergonomic handle
- movable handle with position locking system
- long bar for work in deeply set, difficult to reach places

- ergonomiczna rękojeść
- przesuwane pokrętko z blokadą położenia
- długi trzpień umożliwiający pracę w głębokich wnękach

YATO	Ø H	L1 (mm)	L2 (mm)	Ø (mm)	
YT-1565	1/4" (6.3 mm)	310	200	8	10/40
YT-1566	3/8" (9.5 mm)	310	200	10	10/40
YT-1567	1/2" (12.7 mm)	310	200	10	10/40

1

- GB Insulated T-handle wrench
- D Steckschlüssel T-griff vollisoliert
- PL Rekojęść typu „T” izolowana
- RUS Ручка Т-образная изолированная
- CZ Klič nástrčný typ „T”, izolovaný

- H „T” típusú dugókulcs
- RO Manerț tip „T” izolat
- F Clé à tube en „T” isolée
- I Chiave a bussola tipo „T” isolati
- E Llave tubular „T” aislante
- CN 绝缘T型扳手

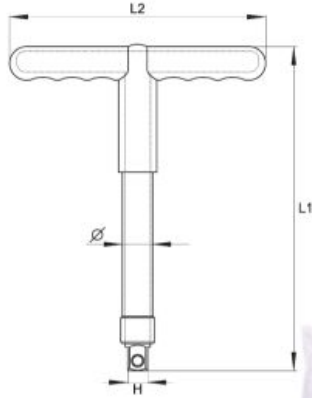
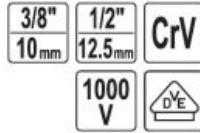

POLYBAG

1000V
VDE CERTIFICATE
EN 60900:2012

YATO	H	L1 (mm)	L2 (mm)	Ø (mm)	
YT-21095	3/8" (9.5 mm)	207	160	15.6	4/32
YT-21096	1/2" (12.7 mm)	207	160	19.3	4/32

- GB T-handle swivel socket wrench
- D T-Griff Steckchlüssel mit Gelenk
- PL Klucz nasadowy z przegubem typu „T”
- RUS Ключ торцевой с карданом Т-образный
- CZ Hlavice ohebná na T-rukojeti matný povrch
- H Csuklós „T” kulcs adatai

- RO Cheie tubulara cu cruce cardanica tip „T”
- F Clé a poignée en „T” longue a cardan
- I Chiave a bussola a „T” con snodo
- E Llave vaso en „T” con cardan
- CN 滑杆方向T型扳手

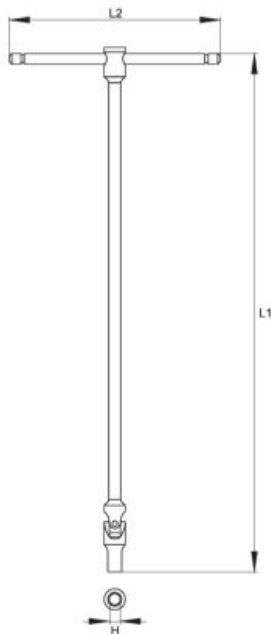

COLOR
CARDBOARD

YATO	H	L1 (mm)	L2 (mm)	
YT-15271	6 mm	450	180	10/40
YT-15272	7 mm	450	180	10/40
YT-15273	8 mm	450	180	10/40
YT-15274	9 mm	450	180	10/40
YT-15275	10 mm	450	180	10/40
YT-15276	11 mm	450	180	10/40
YT-15277	12 mm	450	180	10/40
YT-15278	13 mm	450	180	10/40
YT-15279	14 mm	450	180	10/40
YT-15280	15 mm	450	180	10/40
YT-15281	16 mm	450	180	10/40
YT-15282	17 mm	450	180	10/40
YT-15283	18 mm	450	180	10/40
YT-15284	19 mm	450	180	10/40

- GB T-type deep socket wrench
- D Steckschlüssel vom Typ „T”
- PL Klucz nasadowy typu „T”
- RUS Торцовый ключ типа „T”
- CZ Klič nástrčný typ „T”
- H „T” típusú dugókulcs

- RO Cheie tubulară de tip „T”
- F Clé à tube en „T”
- I Chiave a bussola tipo „T”
- E Llave tubular „T”
- CN T型套筒扳手

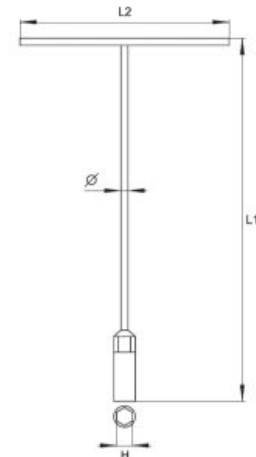

COLOR
CARDBOARD

YATO	H	L1 (mm)	L2 (mm)	Ø (mm)	
YT-1571	8 mm	310	200	10	10/40
YT-1573	10 mm	310	200	10	10/40
YT-1574	11 mm	310	200	10	10/40
YT-1575	12 mm	310	200	10	10/40
YT-1576	13 mm	310	200	10	10/40
YT-1577	14 mm	310	200	10	10/40
YT-1578	15 mm	310	200	10	10/40

- GB T-handle swivel adapter
- D T-Griff Steckchlüssel mit Gelenk
- PL Klucz z przegubem typu „T”
- RUS Вороток Т-образный с карданом
- CZ „T” klič sa kloubem
- H Csuklós T-hajtószár
- RO Adaptor tip „T” cu cruce cardanica

- F Clé a poignée en „T” longue a cardan
- I Chiave a „T” con snodo
- E Alargadera a cardan
- CN 滑杆方向T型接头

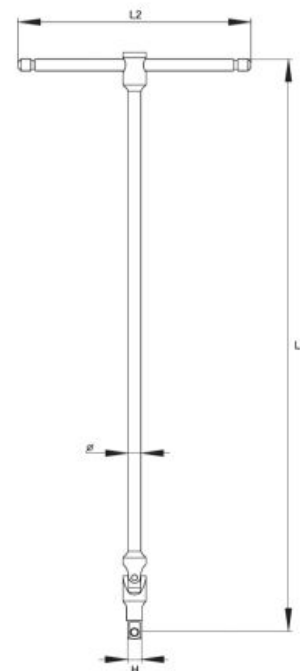

COLOR
CARDBOARD

YATO	H	L1 (mm)	L2 (mm)	
YT-15291	1/4" (6.3 mm)	450	180	10/40
YT-15292	3/8" (9.5 mm)	450	180	10/40
YT-15293	1/2" (12.7 mm)	450	180	10/40

GB Adjustable wrench
D Rollgabelschlüssel
PL Klucz nastawny
RUS Ключ разводной
CZ Nastavitelný klíč
H Állítható svédkulcs
RO Cheie reglabilă

F Clé à molette
I Chiave a rullino graduata
E Llave ajustable tipo inglesa
CN 活络扳手



HALF
DOUBLE
BLISTER



150 mm 200 mm 250 mm 300 mm 375 mm

YATO	L (mm)	
YT-2071	150	6/60
YT-2072	200	6/60
YT-2073	250	6/36
YT-2074	300	6/24
YT-2075	375	6/12



150 mm 200 mm 250 mm 300 mm DIN 3117 CrV

YATO	L (mm)	
YT-2165	150	6/120
YT-2166	200	6/60
YT-2167	250	6/36
YT-2168	300	6/24



150 mm 200 mm 250 mm 300 mm DIN 3117 CrV

YATO	L (mm)	
YT-2170	150	6/72
YT-2171	200	6/60
YT-2172	250	6/48
YT-2173	300	6/36



150 mm 200 mm 250 mm 300 mm 375 mm DIN 3117 DROP FORGED KUTE

YATO	L (mm)	opening capacity (mm) zakres rozwarcia szczek (mm)	
YT-21650	150	19.3	6/60
YT-21651	200	24.0	6/60
YT-21652	250	30.0	6/36
YT-21653	300	36.0	6/24
YT-21654	375	45.0	2/16



150 mm 200 mm 250 mm 300 mm CrV DROP FORGED KUTE

YATO	L (mm)	opening capacity (mm) zakres rozwarcia szczek (mm)	
YT-21655	150	34	6/72
YT-21656	200	38	6/36
YT-21657	250	50	6/36
YT-21658	300	60	6/24

GB Insulated adjustable wrench
D Rollgabelschlüssel isoliert
PL Klucz nastawny izolowany

RUS Ключ разводной изолированный
CZ Izolovaný stavitelný klíč

H Állítható svédkulcs
RO Cheie reglabilă izolată
F Clé à molette isolée

I Isolati chiave regolabile
E Llave ajustable aislante
CN 绝缘活络扳手

POLYBAG



200 mm 250 mm 300 mm
CrV 1000 V DVE

1000V
VDE CERTIFICATE
EN 60900:2012

YATO	L (mm)	
YT-20940	200	6/48
YT-20941	250	6/36
YT-20942	300	4/24



GB Flexible hook wrench
D Hakenschlüssel
PL Klucz hakowy

RUS Ключ сегментный шарнирный
CZ Hákový klíč

H Kőrmös kulcs
RO Cheie universală cu carlig
F Clé à crochet

I Chiave a settore
E Llave de gancho articulada
CN 方头钩型扳手

CrV



YATO	L (mm)	opening capacity (mm) zakres rozwarcia szczek (mm)	
YT-01670	170	15-35	10/50
YT-01671	210	35-50	10/50
YT-01672	280	50-80	10/50
YT-01673	340	80-120	5/10
YT-01674	470	120-180	5/10





















YATO	L (mm)	opening capacity (mm) zakres rozwarcia szczek (mm)	
YT-01675	170	15-35	10/50
YT-01676	210	35-50	10/50
YT-01677	280	50-80	10/50
YT-01678	340	80-120	5/10
YT-01679	470	120-180	5/10











2

Sockets, accessories & sets
Klucze nasadowe,
akcesoria i zestawy



Sockets 1/4"			21	Klucze nasadowe 1/4"	Extension bars with wobble	26
Hexagonal sockets				Przedłużki uchylne	26	
Klucze nasadowe sześciokątne, krótkie				Adapters	26	
Hexagonal deep sockets			21-22	Klucze nasadowe sześciokątne, długie	Bit adapters	26
Accessories 1/4"				Adaptery do bitów	26	
Akcesoria 1/4"				Universal joints	26	
Hexagonal sockets			27-29	Klucze nasadowe sześciokątne, krótkie	Sliding T-bars	26
Klucze nasadowe sześciokątne, długie				Pokręta typu „T”	26	
Accessories 1/4"				Flexible handles	27	
Akcesoria 1/4"			29-30	Klucze nasadowe do świec	Ratchet handles 3/8"	27
Extension bars				Grzechotki 3/8"	27	
Przedłużki				Ratchet handles	27	
Extension bars with wobble			23-24	Przedłużki uchylne	Grzechotki	28
Flexible extension cords				Flexible ratchet handles	28	
Przedłużki elastyczne				Grzechotki z przegubem	28	
Adapters			31-32	Redukcje	Composite ratchet handles	28
Bit adapters				Grzechotki powlekane	28	
Adaptery do bitów				Insulated ratchet handles	28	
Universal joints			31-32	Przeguby Cardana	Grzechotki izolowane	28
Spinner handles				Grzechotki wygięte	28	
Pokręta do nasadek				Curved ratchet handles	28	
Sliding T-bars			24	Pokręta typu „T”	Grzechotki wygięte	28
Flexible handles				Telescopic ratchet handles	28	
Pokręta łamane				Grzechotki z przedłużonym uchwytem	29	
Ratchet handles 1/4"			29-30	Grzechotki 1/4"	Sockets 1/2"	29
Klucze nasadowe 1/4"				Klucze nasadowe 1/2"	29	
Hexagonal sockets				Klucze nasadowe sześciokątne, krótkie	29	
Ratchet handles			31-32	Grzechotki	Insulated hexagonal sockets	29
Flexible ratchet handles				Klucze nasadowe sześciokątne izolowane, krótkie	29	
Grzechotki z przegubem				Bi-hexagonal sockets	30	
Composite ratchet handles			30	Grzechotki powlekane	Klucze nasadowe dwunastokątne, krótkie	30
Grzechotki powlekane				Spline sockets	30	
Curved ratchet handles				Klucze nasadowe „Spline”	30	
Grzechotki wygięte			31-32	Hexagonal deep sockets	Klucze nasadowe sześciokątne, długie	30
Telescopic ratchet handles				Bi-hexagonal deep sockets	30	
Grzechotki z przedłużonym uchwytem				Klucze nasadowe dwunastokątne, długie	30	
Bit and socket drive ratchet handles			24	Grzechotki do bitów i nasadek	Accessories 1/2"	31
Grzechotki do bitów i nasadek				Akcesoria 1/2"	31	
Rotary head ratchet handles				Extension bars	31	
Grzechotki z obrotową głowicą			31-32	Przedłużki	Insulated extension bars	31
Sockets 3/8"				Przedłużki izolowane	31	
Klucze nasadowe 3/8"				Extension bars with wobble	31	
Hexagonal sockets			25	Przedłużki uchylne	Adapters	31
Klucze nasadowe sześciokątne, krótkie				Redukcje	31	
Insulated hexagonal sockets				Bit adapters	31	
Klucze nasadowe sześciokątne izolowane, krótkie			25	Adaptery do bitów	Universal joints	32
Hexagonal deep sockets				Przeguby Cardana	32	
Klucze nasadowe sześciokątne, długie				Sliding T-bars	32	
Accessories 3/8"			25-27	Akcesoria 3/8"	Pokręta typu „T”	32
Klucze nasadowe sześciokątne, długie				Flexible handles	32	
Hexagonal sockets				Pokręta łamane	32	
Klucze nasadowe sześciokątne, krótkie			25	Klucze nasadowe sześciokątne, długie	L-type handles	32
Insulated hexagonal sockets				Pokręta typu „L”	32	
Hexagonal deep sockets				Spark plug sockets	32	
Klucze nasadowe sześciokątne izolowane, krótkie			26	Klucze nasadowe do świec	Klucze nasadowe do świec	32
Hexagonal deep sockets				Klucze nasadowe do świec	32	
Klucze nasadowe sześciokątne, długie				Klucze nasadowe do świec	32	



<p>Ratchet handles 1/2" Grzechotki 1/2"</p> <p style="text-align: right;">33-34 </p>	<p>Torx sockets & sets Klucze nasadowe „Torx” i zestawy</p> <p style="text-align: right;">49 </p>
<p>Ratchet handles Grzechotki..... 33</p> <p>Flexible ratchet handles Grzechotki z przegubem..... 33</p> <p>Composite ratchet handles Grzechotki powlekane..... 33</p> <p>Insulated ratchet handles Grzechotki izolowane..... 33</p> <p>Curved ratchet handles Grzechotki wygięte..... 34</p> <p>Telescopic ratchet handles Grzechotki z przedłużonym uchwytem..... 34</p> <p>Rotary head ratchet handles Grzechotki z obrotową głowicą..... 34</p> <p>Step wrenches Klucze sztorcowe..... 34</p>	<p>Sockets 3/4" Klucze nasadowe 3/4"</p> <p style="text-align: right;">50 </p>
<p>Socket sets Zestawy kluczy nasadowych</p> <p style="text-align: right;">35-46 </p>	<p>Accessories 3/4" Akcesoria 3/4"</p> <p style="text-align: right;">50-51 </p>
<p>Socket sets 1/4" Zestawy kluczy nasadowych 1/4"..... 35</p> <p>Socket sets 3/8" Zestawy kluczy nasadowych 3/8"..... 37</p> <p>Socket sets 1/2" Zestawy kluczy nasadowych 1/2"..... 37</p> <p>Socket sets 1/2", 1/4" Zestawy kluczy nasadowych 1/2", 1/4"..... 38</p> <p>Socket sets 1/2", 3/8", 1/4" Zestawy kluczy nasadowych 1/2", 3/8", 1/4"..... 42</p>	<p>Extension bars Przedłużki..... 50</p> <p>Adapters Redukcje..... 50</p> <p>Universal joints Przeguby Cardana..... 50</p> <p>Sliding T-bars Pokręta typu „T”..... 50</p> <p>Flexible handles Pokręta łamane..... 51</p> <p>L-type handles Pokręta typu „L”..... 51</p>
<p>Socket sets Zestawy kluczy nasadowych</p> <p style="text-align: right;">47 </p>	<p>Ratchet handles 3/4" Grzechotki 3/4"</p> <p style="text-align: right;">51 </p>
<p>Socket sets 1/4" Zestawy kluczy nasadowych 1/4"..... 47</p> <p>Socket sets 1/2" Zestawy kluczy nasadowych 1/2"..... 47</p>	<p>Socket sets 3/4" Zestawy kluczy nasadowych 3/4"</p> <p style="text-align: right;">51 </p>
<p>Tool sets Zestawy narzędziowe</p> <p style="text-align: right;">47-49 </p>	<p>Bit sockets & sets 1/4", 3/8", 1/2" Klucze trzpieniowe i zestawy 1/4", 3/8", 1/2"</p> <p style="text-align: right;">52-54 </p>

GB Hexagonal socket
D Sechskantenschlüssel
PL Nasadka sześciokątna
RUS Головка шестигранная короткая
CZ Šestihřanný nástavec
H Hatszögű rátét
RO Cheie tubulară hexagonală
F Douille courte
I Chiave a bussola esagonale
E Boquilla hexagonal corta
CN 六角套筒



1/4" 6.3mm
DIN 3121
CrV 50BV30 AS-DRIVE

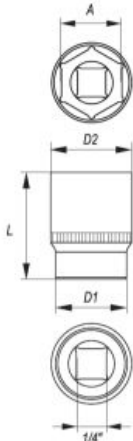

- drive locks
- surface finish: chromed, satin / mirror
- zamki blokujące
- wykończenie powierzchni: chromowana, satynowa / polerowana

COLOR BOX



YATO	Ø A (mm)	D1 (mm)	D2 (mm)	L (mm)	PCS packing	
YT-1401	4.0	7.0	12.0	25	24	240/480
YT-1403	5.0	8.0	12.0	25	24	240/480
YT-1404	5.5	8.5	12.0	25	24	240/480
YT-1405	6.0	9.0	12.0	25	24	240/480
YT-1406	7.0	10.0	12.0	25	24	240/480
YT-1407	8.0	12.0	11.0	25	24	240/480
YT-1408	9.0	13.0	12.0	25	24	240/480
YT-1409	10.0	15.0	12.0	25	24	240/480
YT-1410	11.0	16.0	14.0	25	24	240/480
YT-1411	12.0	17.0	15.0	25	24	240/480
YT-1412	13.0	18.0	16.0	25	24	240/480

GB Hexagonal deep socket
D Sechskantenschlüssel, lange
PL Nasadka sześciokątna długa
RUS Головка шестигранная длинная
CZ Šestihřanný hluboký nástavec
H Hatszögű rátét mély
RO Cheie tubulară hexagonală adâncă
F Douille longue
I Chiave a bussola esagonale
E Boquilla hexagonal larga
CN 六角长套筒



1/4" 6.3mm
DIN 3121
CrV 50BV30 AS-DRIVE

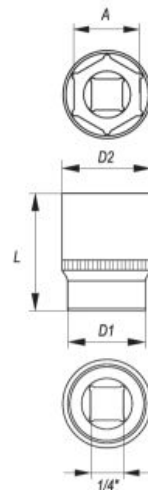

- drive locks
- surface finish: chromed, satin / mirror
- zamki blokujące
- wykończenie powierzchni: chromowana, satynowa / polerowana

COLOR BOX



YATO	Ø A (mm)	D1 (mm)	D2 (mm)	L (mm)	PCS packing	
YT-1413	4.0	7.0	12.0	50	24	240/480
YT-1414	4.5	7.5	12.0	50	24	240/480
YT-1415	5.0	8.0	12.0	50	24	240/480
YT-1416	5.5	8.5	12.0	50	24	240/480
YT-1417	6.0	9.0	12.0	50	24	240/480
YT-1418	7.0	10.0	12.0	50	24	240/480
YT-1419	8.0	12.0	12.0	50	24	240/480
YT-1420	9.0	13.0	12.0	50	24	240/480
YT-1421	10.0	14.0	13.0	50	24	240/480
YT-1422	11.0	16.0	14.0	50	24	120/240
YT-1423	12.0	17.0	15.0	50	24	120/240
YT-1424	13.0	18.0	16.0	50	24	120/240

GB Extension bar
D Verlängerung
PL Przedłużka
RUS Удлинитель для воротка
CZ Prodlužovací přípravek
H Toldalék
RO Prelungitor
F Rallonge
I Prolunga
E Tubo de prolongación
CN 接杆

1/4" 6.3mm
DIN 3121
CrV 50BV30

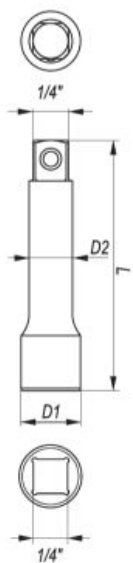

COLOR BOX



YATO	Ø	D1 (mm)	D2 (mm)	L (mm)	PCS packing	
YT-1429	1/4" (6.3 mm)	12.4	8.3	50.8	30	150/300
YT-1430	1/4" (6.3 mm)	12.4	8.3	76.0	30	150/300
YT-1431	1/4" (6.3 mm)	12.4	8.3	101.6	20	100/200
YT-1432	1/4" (6.3 mm)	12.4	8.3	152.4	20	100/200

GB Extension bar with wobble
D Gelenkverlängerung
PL Przedłużka uchylna
RUS Удлинитель наклонный
CZ Odchylný prodlužovací přípravek
H Csuklós toldalék
RO Prelungitor rabatabil
F Rallonge angulaire
I Prolunga
E Tubo de prolongación desviable
CN 转向接杆

1/4" 6.3mm
DIN 3121
CrV 50BV30

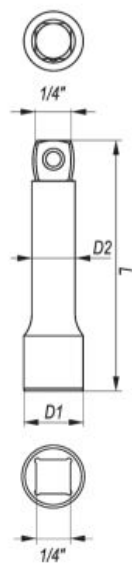

COLOR BOX



YATO	Ø	D1 (mm)	D2 (mm)	L (mm)	PCS packing	
YT-1433	1/4" (6.3 mm)	12.4	8.3	50.8	30	150/300
YT-1434	1/4" (6.3 mm)	12.4	8.3	76.0	30	150/300
YT-1435	1/4" (6.3 mm)	12.4	8.3	101.6	20	100/200
YT-1436	1/4" (6.3 mm)	12.4	8.3	152.4	20	100/200

GB Extension bar
D Verlängerung
PL Przedłużka elastyczna
RUS Удлинитель для воротка

CZ Prodlužovací přípravek
H Toldalék
RO Prelungitor
F Rallonge élastique

I Prolunga flessibile
E Tubo de prolongación
CN 可弯式接杆

COLOR BOX



1/4" CrV
6.3mm 6140



YATO	Ø	Ø	D (mm)	L (mm)	PCS packing	Box
YT-1400	1/4" (6.3 mm)	1/4" (6.3 mm)	11.6	150	25	250/500

GB Extension bar
D Verlängerung
PL Przedłużka elastyczna
RUS Удлинитель для воротка

CZ Prodlužovací přípravek
H Toldalék
RO Prelungitor
F Rallonge élastique

I Prolunga flessibile
E Tubo de prolongación
CN 可弯式接杆

1/4" CrV
6.3mm 6140



YATO	Ø	Ø	D (mm)	L (mm)	PCS packing	Box
YT-14001	1/4" (6.3 mm)	1/4" (6.3 mm)	11.7	300	100	

SLIDING CARD

GB Adapter
D Reduktion
PL Redukcja
RUS Переходник
CZ Redukce
H Redukció
RO Reducție
F Réduction
I Riduttore
E Reducción
CN 转换头

COLOR BOX

1/4" DIN CrV
6.3mm 3121 50BV30

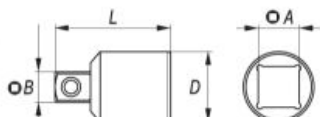

YATO	Ø A	Ø B	D (mm)	L (mm)	PCS packing	Box
YT-1438	1/4" (6.3 mm) (F)	3/8" (9.5 mm) (M)	12	25	10	250/500

GB Bit adapter
D Bithalter
PL Adapter do bitów
RUS Держатель винтовёртовых наконечников
CZ Držák na šroubovakové koncovky
H Szár a csavarhúzóvégekhez
RO Capete şurubelniţă
F Adapteur d'embouts
I Chiave esagonale a bussola
E Mandril para puntas
CN 旋具头接头

COLOR BOX

1/4" CrV
6.3mm 6140

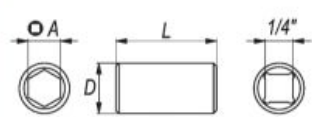

YATO	Ø	Ø A	D (mm)	L (mm)	PCS packing	Box
YT-1297	1/4" (6.3 mm)	1/4" (6.3 mm)	11.8	24	10	250/1000

GB Universal joint
D Kardangelen
PL Przegub Cardana
RUS Карданный шарнир
CZ Kardanový kloub
H Kardan csukló

RO Articulație Cardanică
F Cardan
I Snodo cardanico
E Articulación Cardan
CN 万向接头

1/4" DIN CrV
6.3mm 3121 50BV30

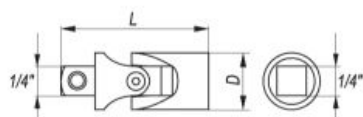

YATO	Ø	D (mm)	L (mm)	PCS packing	Box
YT-1437	1/4" (6.3 mm)	14	35	20	120/240

GB Spinner handle
D Drehgriff für steckschlüssel
PL Pokrętko do nasadek
RUS Ручка с соединением под головки
CZ Nástavec ruční na bity
H Csavarhúzószár

RO Prelungitor antrenor pt. biti
F Barre
I Porta bussola con manico
E Destornillador con cuadradillo
CN 旋柄

1/4" CrV
6.3mm 50BV30



COLOR BOX

YATO	Ø	L (mm)	PCS packing	Box
YT-1427	1/4" (6.3 mm)	150	12	48

GB Sliding T-bar
D Handgriff mit Gleitstück
PL Pokrętko typu „T”
RUS Вороток Т-образный
CZ Otočná ráčka typ „T”

H „T” alakú hajtókar
RO Măner clupă tipul „T”
F Barre type „T”
I Manopola „T” scorrevole
E Mango tipo „T”
CN 滑行杆

1/4" DIN CrV
6.3mm 3121 50BV30

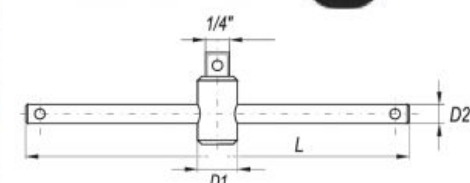

YATO	Ø	D1 (mm)	D2 (mm)	L (mm)	PCS packing	Box
YT-1426	1/4" (6.3 mm)	13.3	6.3	152.4	10	100/200

GB Flexible handle
D Gelenkgriff
PL Pokrętko lamane
RUS Вороток шарнирный
CZ Otočná lomená ráčka
H Hajlított hajtókar

RO Prelungitor cu prindere flexibilă
F Barre pivotante
I Manopola a snodo
E Mango articulado
CN 转向手柄

1/4" DIN CrV
6.3mm 3121 50BV30

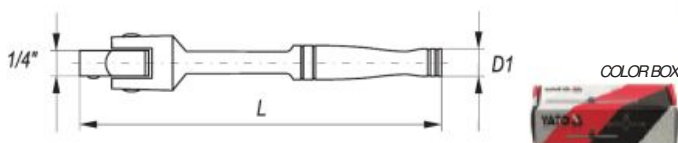

YATO	Ø	D (mm)	L (mm)	PCS packing	Box
YT-1425	1/4" (6.3 mm)	13	140	10	100/200

GB Quick release ratchet handle
D Hebelumschaltknarre
PL Grzechotka
RUS Трещотка
CZ Řehťačka
H Racsnis hajtókár

RO Dispozitiv de prindere cu clichet
F Clé à cliquet
I Cricchetto bussola
E Carraca
CN 快速脱落棘轮扳手

PLASTIC HANGER



12 PCS



COLOR BOX

1/4"
6.3mm

DIN
3122

QUICK
RELEASE
SZYBKO-
ZŁĄCZE

72T

CrV
6140



YATO	Ø	T	L (mm)	PCS packing	Box
YT-0307	1/4" (6.3 mm)	72	146	12	24/96

YATO	Ø	T	L (mm)	PCS packing	Box
YT-0310	1/4" (6.3 mm)	72	125	12	36/72

YATO	Ø	T	L (mm)	PCS packing	Box
YT-0313	1/4" (6.3 mm)	72	125	12	24/96



YATO	Ø	T	L (mm)	PCS packing	Box
YT-0316	1/4" (6.3 mm)	72	145	12	24/96

YATO	Ø	T	L (mm)	PCS packing	Box
YT-0319	1/4" (6.3 mm)	72	145	12	48/96

YATO	Ø	T	L (mm)	PCS packing	Box
YT-0322	1/4" (6.3 mm)	72	148	12	48/96

GB Quick release ratchet handle
D Hebelumschaltknarre
PL Grzechotka
RUS Трещотка
CZ Řehťačka
H Racsnis hajtókár

RO Dispozitiv de prindere cu clichet
F Clé à cliquet
I Cricchetto bussola
E Carraca
CN 快速脱落棘轮扳手

PLASTIC HANGER



12 PCS



COLOR BOX

1/4"
6.3mm

DIN
3122

QUICK
RELEASE
SZYBKO-
ZŁĄCZE

72T

CrV
6140

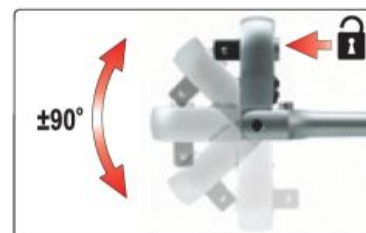

YATO	Ø	T	L (mm)	PCS packing	Box
YT-0325	1/4" (6.3 mm)	72	159	12	48/96

GB Quick release ratchet handle
D Hebelumschaltknarre
PL Grzechotka powlekana
RUS Трещотка
CZ Řehťačka
H Racsnis hajtókár

RO Dispozitiv de prindere cu clichet
F Clé à cliquet
I Cricchetto bussola
E Carraca
CN 快速脱落棘轮扳手

PLASTIC HANGER



12 PCS



COLOR BOX

1/4"
6.3mm

DIN
3122

QUICK
RELEASE
SZYBKO-
ZŁĄCZE

72T

CrV
6135



YATO	Ø	T	L (mm)	PCS packing	Box
YT-0290	1/4" (6.3 mm)	72	144	12	48/96

YATO	Ø	T	L (mm)	PCS packing	Box
YT-0293	1/4" (6.3 mm)	72	144	12	48/96

GB Quick release ratchet handle
 D Hebelumschaltknarre
 PL Grzechotka
 RUS Трещотка
 CZ Řehtačka
 H Racsnis hajtókar
 RO Dispozitiv de prindere cu clichet
 F Clé à cliquet
 I Cricchetto bussola
 E Carraca
 CN 快速脱落棘轮扳手

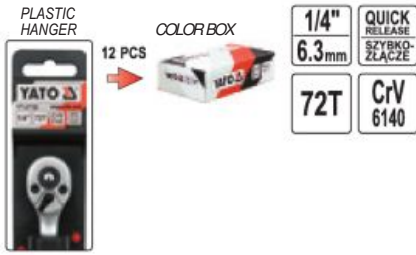

1/4" QUICK RELEASE SZYBKO-ZŁĄCZE
 6.3mm
 72T CrV 6140



YATO	Ø	T	L (mm)	PCS packing	
YT-0730	1/4" (6.3 mm)	72	155	12	96

GB Quick release ratchet handle
 D Hebelumschaltknarre
 PL Grzechotka
 RUS Трещотка
 CZ Řehtačka
 H Racsnis hajtókar
 RO Dispozitiv de prindere cu clichet
 F Clé à cliquet
 I Cricchetto bussola
 E Carraca
 CN 快速脱落棘轮扳手

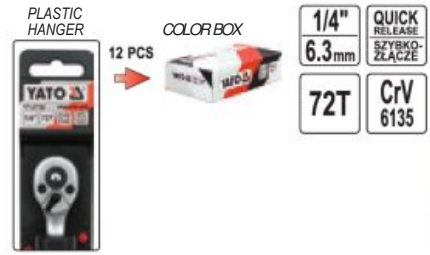

1/4" QUICK RELEASE SZYBKO-ZŁĄCZE
 6.3mm
 72T CrV 6135



YATO	Ø	T	L (mm)	PCS packing	
YT-0733	1/4" (6.3 mm)	72	155	12	24/96

GB Telescopic ratchet handle
 D Umschaltknarre
 PL Grzechotka z przedłużanym uchwytem
 RUS Трещотка
 CZ Řehtačka
 H Racsnis hajtókar
 RO Antrenor cu clichet
 F Clé à cliquet
 I Cricchetto bussola
 E Carraca telescópico
 CN 可伸缩快速脱落棘轮扳手

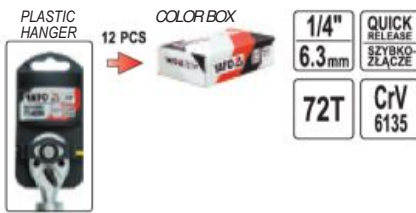

1/4" QUICK RELEASE SZYBKO-ZŁĄCZE
 6.3mm
 72T CrV 6135



YATO	Ø	T	L (mm)	PCS packing	
YT-0297	1/4" (6.3 mm)	72	150-200	12	48

GB Ratchet handle and bit drive
 D Bit- und Steckschlüssel-Umschaltknarre
 PL Grzechotka do bitów i nasadek
 RUS Трещотка для битов и головок
 CZ Ráčna kombinovaná pro bity a nástrčné kľíče
 H Bit és dugófej behajtó racsnis hajtókar
 RO Antrenor cu clichet / antrenor pt. biti
 F Clé à cliquet
 I Cricchetto bussola per punte e snodi
 E Carraca para boquillas y puntas
 CN 套筒旋具两用棘轮扳手



1/4" DIN 3122
 6.3mm
 QUICK RELEASE SZYBKO-ZŁĄCZE
 72T CrV 6140



YATO	Ø	T	L (mm)	PCS packing	
YT-0331	1/4" (6.3 mm)	72	136	12	48

GB Swivel ratchet handle for bits and sockets
 D Umschaltknarre mit Außenverkanttrieb
 PL Grzechotka z obrotową głowicą do bitów i nasadek
 RUS Трещотка реверсивная
 CZ Ráčna s otočnou hlavou
 H Forgófejes racsnis szár
 RO Antrenor cu clichet flexibil
 F Clé à cliquet tête pivotante
 I Cricchetto bussola per punte e snodi
 E Carraca con cabeza giratoria
 CN 旋轉頭套筒旋具兩用棘輪扳手

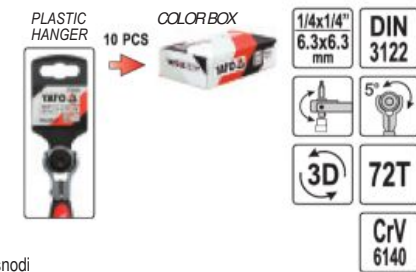

1/4x1/4" DIN 3122
 6.3x6.3 mm
 5°
 3D
 72T CrV 6140



YATO	Ø	T	L (mm)	PCS packing	
YT-0331	1/4" (6.3 mm) x 1/4" (6.3 mm)	72	115	10	100

GB Flexible ratchet handle / round head
 D Flexible Drehkopfratsche
 PL Grzechotka z obrotową głowicą
 RUS Трещотка с вращательной головкой
 CZ Ráčna s otočnou hlavou
 H Forgófejes racsnis szár
 RO Antrenor cu clichet flexibil
 F Clé à cliquet tête pivotante
 I Cricchetto bussola reversibile con ghiera
 E Carraca con cabeza giratoria
 CN 旋轉頭快速脱落棘轮扳手

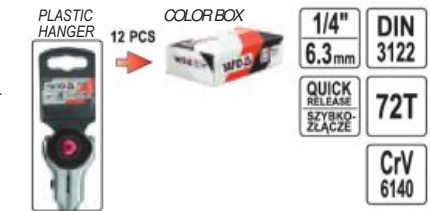

1/4" DIN 3122
 6.3mm
 QUICK RELEASE SZYBKO-ZŁĄCZE
 72T CrV 6140



YATO	Ø	T	L (mm)	PCS packing	
YT-0720	1/4" (6.3 mm)	72	145	12	24/96

- GB Hexagonal socket
 D Sechskantenschlüssel
 PL Nasadka sześciokątna
 RUS Головка шестигранная короткая
 CZ Šestihřanný nástavec
 H Hatszögű rátét
 RO Cheie tubulară hexagonală
 F Douille courte
 I Chiave a bussola esagonale
 E Boquilla hexagonal corta
 CN 六角套筒

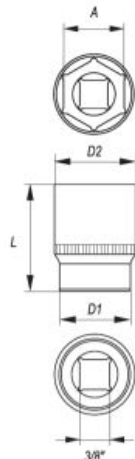

3/8" 10mm
 DIN 3121
 CrV 50BV30
 AS-DRIVE

- drive locks
- surface finish: chromed, satin / mirror
- zamki blokujące
- wykończenie powierzchni: chromowana, satynowa / polerowana



YATO	Ø A (mm)	D1 (mm)	D2 (mm)	L (mm)	PCS packing	
YT-3801	6	10	17	28	24	240/480
YT-3802	7	11	17	28	24	240/480
YT-3803	8	12	17	28	24	240/480
YT-3804	9	13	17	28	24	240/480
YT-3805	10	14	17	28	24	240/480
YT-3806	11	16	17	28	24	240/480
YT-3807	12	18	17	28	24	240/480
YT-3808	13	19	18	28	24	240/480
YT-3809	14	20	19	28	24	240/480
YT-3810	15	21	19	28	12	240/480
YT-3811	16	22	21	28	12	240/480
YT-3812	17	24	22	30	12	120/240
YT-3813	18	25	23	30	12	120/240
YT-3814	19	26	24	30	12	120/240

- GB Insulated hexagonal socket
 D Sechskantenschlüssel vollisoliert
 PL Nasadka sześciokątna izolowana
 RUS Головка шестигранная короткая изолированная
 CZ Šestihřanný nástavec, izolovaný
 H Hatszögű rátét
 RO Cheie tubulară hexagonală izolată
 F Douille courte isolée
 I Chiave a bussola esagonale isolato
 E Boquilla hexagonal corta aislante
 CN 绝缘六角套筒

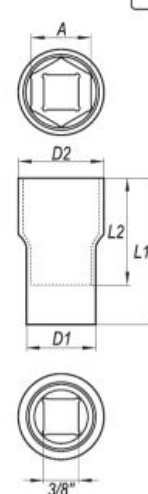

3/8" 10mm
 CrV
 1000 V
 D'E

1000V
 VDE CERTIFICATE
 EN 60900:2012



YATO	Ø A (mm)	D1 (mm)	D2 (mm)	L1 (mm)	L2 (mm)	
YT-21008	8	18	15.1	45	28	7/126
YT-21010	10	18	18.7	45	28	7/126
YT-21011	11	18	20.0	45	28	7/126
YT-21012	12	18	21.2	45	28	7/126
YT-21013	13	18	22.5	45	28	7/126
YT-21014	14	18	23.7	45	28	7/126
YT-21016	16	18	26.2	45	28	7/126
YT-21017	17	18	27.5	45	28	7/126
YT-21018	18	18	28.7	45	30	5/90
YT-21019	19	18	30.0	47	30	5/90
YT-21021	21	18	32.6	47	30	5/90
YT-21022	22	18	33.7	47	30	5/90

- GB Hexagonal deep socket
 D Sechskantenschlüssel, lange
 PL Nasadka sześciokątna długa
 RUS Головка шестигранная длинная
 CZ Šestihřanný hluboký nástavec
 H Hatszögű rátét mély
 RO Cheie tubulară hexagonală adâncă
 F Douille longue
 I Chiave a bussola esagonale
 E Boquilla hexagonal larga
 CN 六角长套筒

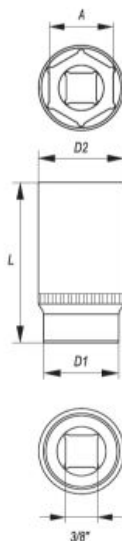

3/8" 10mm
 DIN 3121
 CrV 50BV30
 AS-DRIVE

- drive locks
- surface finish: chromed, satin / mirror
- zamki blokujące
- wykończenie powierzchni: chromowana, satynowa / polerowana



YATO	Ø A (mm)	D1 (mm)	D2 (mm)	L (mm)	PCS packing	
YT-3820	6	10	17	63	24	48/96
YT-3821	7	10	17	63	24	48/96
YT-3822	8	12	17	63	24	48/96
YT-3823	9	13	17	63	24	48/96
YT-3824	10	14	17	63	24	48/96
YT-3825	11	16	17	63	24	48/96
YT-3826	12	18	17	63	24	48/96
YT-3827	13	19	17	63	24	48/96
YT-3828	14	20	19	63	24	48/96
YT-3829	15	21	19	63	12	60/120
YT-3830	16	22	20	63	12	60/120
YT-3831	17	24	23	63	12	60/120
YT-3832	18	25	23	63	12	60/120
YT-3833	19	26	24	63	12	60/120

- GB Extension bar
 D Verlängerung
 PL Przedłużka
 RUS Удлинитель для воротка
 CZ Prodlužovací příravek
 H Toldalék
 RO Prelungitor
 F Rallonge
 I Prolunga
 E Tubo de prolongación
 CN 接杆

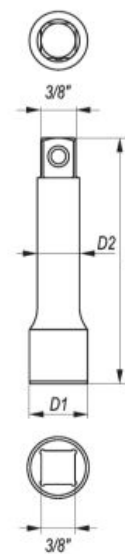

3/8" 10mm
 DIN 3121
 CrV 50BV30

YATO	Ø	D1 (mm)	D2 (mm)	L (mm)	PCS packing	
YT-3842	3/8" (9.5 mm)	18.0	12.3	42.0	10	100/200
YT-3843	3/8" (9.5 mm)	18.0	12.3	76.0	10	100/200
YT-3844	3/8" (9.5 mm)	18.0	12.3	152.4	10	50/100
YT-3845	3/8" (9.5 mm)	18.0	12.3	254.0	10	50



- GB Insulated extension bar
 D Verlängerung vollisoliert
 PL Przedłużka izolowana
 RUS Удлинитель для воротка
 CZ Prodlužovací přípravek, izolovaný
 H Toldalék
 RO Prelungitor izolat
 F Rallonge isolée
 I Prolunga isolato
 E Tubo de prolongación aislante
 CN 绝缘接杆

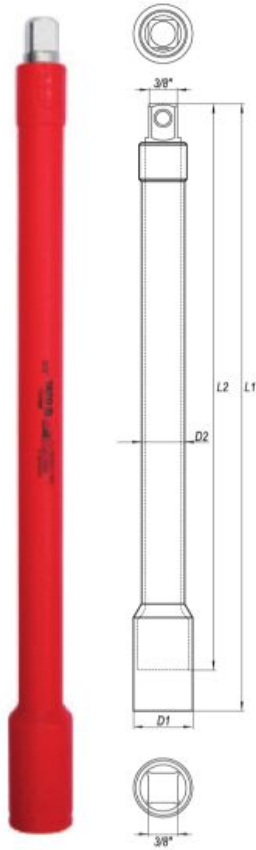

- 3/8"
 10mm
 CrV
 1000 V

POLYBAG

1000V
 VDE CERTIFICATE
 EN 60900:2012

YATO	Ø	D1 (mm)	D2 (mm)	L1 (mm)	L2 (mm)	PCS packing
YT-21055	3/8" (9.5 mm)	23	15.5	125	141	18/72
YT-21056	3/8" (9.5 mm)	23	15.5	250	266	12/48

- GB Extension bar with wobble
 D Gelenkverlängerung
 PL Przedłużka uchylna
 RUS Удлинитель наклонный
 CZ Odchylný prodlužovací přípravek
 H Csuklós toldalék
 RO Prelungitor rabatabil
 F Rallonge angulaire
 I Prolunga
 E Tubo de prolongación desviable
 CN 转向接杆



- 3/8"
 10mm
 DIN 3121
 CrV 50BV30

COLOR BOX

YATO	Ø	D1 (mm)	D2 (mm)	L (mm)	PCS packing
YT-3847	3/8" (9.5 mm)	18.0	12.3	76.0	10
YT-3848	3/8" (9.5 mm)	18.0	12.3	152.4	10
YT-3849	3/8" (9.5 mm)	18.0	12.3	254.0	10

- GB Adapter
 D Reduktion
 PL Redukcja
 RUS Переходник
 CZ Redukce
 H Redukció
 RO Reducție
 F Réduction
 I Riduttore
 E Reducción
 CN 转换头

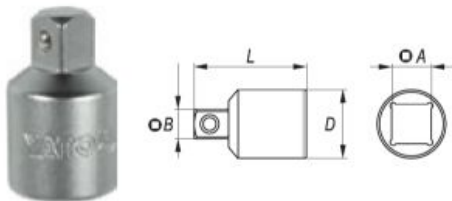

- 3/8"
 10mm
 DIN 3121
 CrV 50BV30

COLOR BOX

YATO	Ø A	Ø B	D (mm)	L (mm)	PCS packing
YT-3853	3/8" (9.5 mm) (F)	1/4" (6.3 mm) (M)	17	27	10
YT-3854	3/8" (9.5 mm) (F)	1/2" (12.7 mm) (M)	17	35	10

- GB Bit adapter
 D Bithalter
 PL Adapter do bitów
 RUS Держатель винтовёртовых наконечников
 CZ Držák na šroubovavkové koncovky
 H Szár a csavarhúzóvégekhez
 RO Capete şurubelniţă
 F Adaptateur d'embouts
 I Chiave esagonale a bussola
 E Mandril para puntas
 CN 旋具头接头

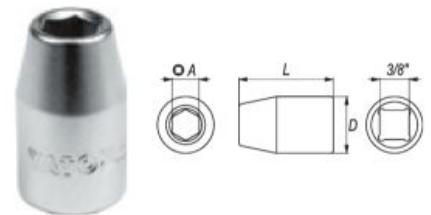

- 3/8"
 10mm
 CrV 6140

COLOR BOX

YATO	Ø	Ø A	D (mm)	L (mm)	PCS packing
YT-1296	3/8" (9.5 mm)	8 mm	17.9	30	10

- GB Universal joint
 D Kardangelen
 PL Przegub Cardana
 RUS Карданный шарнир
 CZ Kardanový kloub
 H Kardán csukló
 RO Articulație Cardanică
 F Cardan
 I Snodo cardanico
 E Articulación Cardan
 CN 万向接头

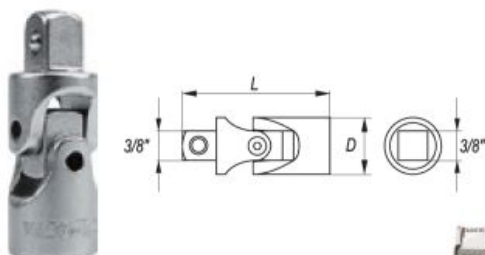

- 3/8"
 10mm
 DIN 3121
 CrV 50BV30

COLOR BOX

YATO	Ø	D (mm)	L (mm)	PCS packing
YT-3850	3/8" (9.5 mm)	18	49	10

- GB Sliding T-bar
 D Handgriff mit Gleistück
 PL Pokrętko typu „T”
 RUS Вороток Т-образный
 CZ Otočná račka typ „T”
 H „T” alakú hajtókar
 RO Mâner clupă tipul „T”
 F Barre type „T”
 I Manopola „T” scorrevole
 E Mango tipo „T”
 CN 滑行杆

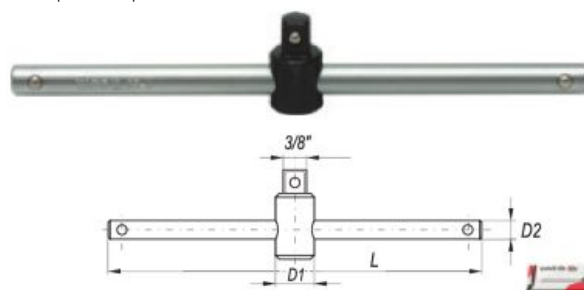

- 3/8"
 10mm
 DIN 3121
 CrV 50BV30

COLOR BOX

YATO	Ø	D1 (mm)	D2 (mm)	L (mm)	PCS packing
YT-3840	3/8" (9.5 mm)	20.0	10.7	198	10

GB Flexible handle
D Gelenkgriff
PL Pokreślto lamane

RUS Вороток шарнирный
CZ Otočná lomená ráčka
H Hajlított hajtókár

RO Prelungitor
cu prindere flexibilă
F Barre pivotante

I Manopola a snodo
E Mango articulado
CN 转向手柄

3/8"
10mm
DIN
3121
CrV
50BV30

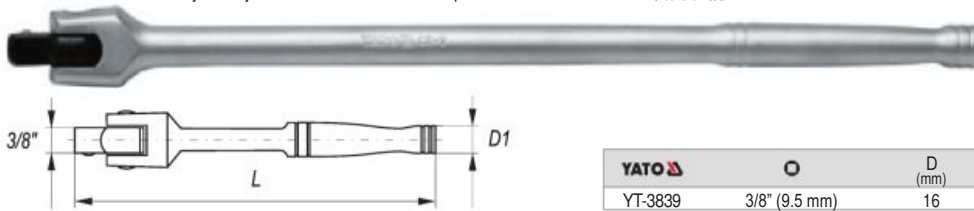

YATO	Ø	D (mm)	L (mm)	PCS packing	Box
YT-3839	3/8" (9.5 mm)	16	215	8	24/48

GB Spark plug socket
D Steckschlüssel
mit Gummihalterung
PL Nasadka do świec
RUS Головка свечная
CZ Nastavec pro svíčky

H Gyújtógyertya toldalék
RO Cheie de bujii
F Douille à bougies
I Chiavi a bussola
RUS Головка свечная
CN 六角火花塞套筒



GB Spark plug socket
D Steckschlüssel
mit Gummihalterung
PL Nasadka do świec
RUS Головка свечная
CZ Nastavec pro svíčky

H Gyújtógyertya toldalék
RO Cheie de bujii
F Douille à bougies
I Chiavi a bussola
RUS Головка свечная
CN 六角火花塞套筒

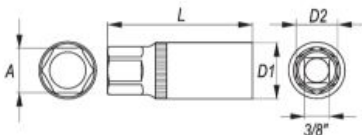

YATO	Ø	A	D1 (mm)	D2 (mm)	L (mm)	PCS packing	Box
YT-3851	3/8" (9.5 mm)	16.0	22.0	19.0	64.0	10	50/100

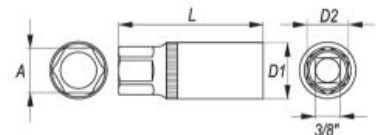

YATO	Ø	A	D1 (mm)	D2 (mm)	L (mm)	PCS packing	Box
YT-3841	3/8" (9.5 mm)	18.0	25.8	19.0	63	25	50/100

GB Spark plug socket
D Steckschlüssel
mit Gummihalterung
PL Nasadka do świec
RUS Головка свечная
CZ Nastavec pro svíčky
H Gyújtógyertya
toldalék
RO Cheie de bujii
F Douille à bougies
I Chiavi a bussola
E Boquilla de bujías
CN 六角火花塞套筒

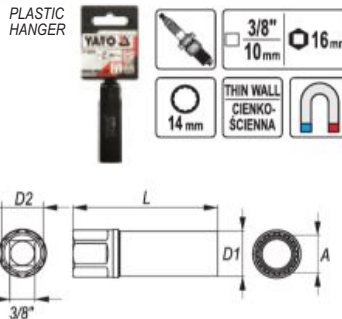

YATO	Ø	A	D1 (mm)	D2 (mm)	L (mm)	PCS packing	Box
YT-38510	3/8" (9.5 mm)	14	18	16	63	25/100	

GB Spark plug socket
D Steckschlüssel
mit Gummihalterung
PL Nasadka do świec
RUS Головка свечная
CZ Nastavec pro svíčky
H Gyújtógyertya
toldalék
RO Cheie de bujii
F Douille à bougies
I Chiavi a bussola
E Boquilla de bujías
CN 六角火花塞套筒

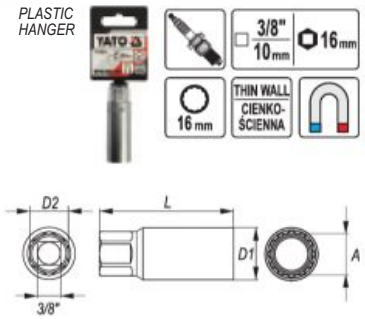

YATO	Ø	A	D1 (mm)	D2 (mm)	L (mm)	PCS packing	Box
YT-38511	3/8" (9.5 mm)	16	20	16	62	25/100	

GB Spark plug socket
D Steckschlüssel
mit Gummihalterung
PL Nasadka do świec
RUS Головка свечная
CZ Nastavec pro svíčky
H Gyújtógyertya
toldalék
RO Cheie de bujii
F Douille à bougies
I Chiavi a bussola
E Boquilla de bujías
CN 六角火花塞套筒

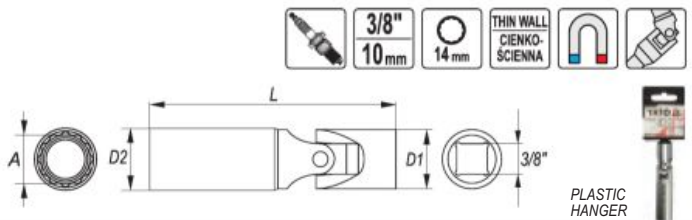

YATO	Ø	A	D1 (mm)	D2 (mm)	L (mm)	PCS packing	Box
YT-38512	3/8" (9.5 mm)	14	19	20	88	25/100	

GB Quick release ratchet handle
D Hebelumschaltknarre
PL Grzechotka
RUS Трещотка
CZ Řehťačka
H Racsnis hajtókár

RO Dispozitiv de prindere cu clichet
F Clé à cliquet
I Cricchetto bussola
E Carraca
CN 快速脱落棘轮扳手



3/8"
10mm
DIN
3122
QUICK
RELEASE
SZYBKO
ZŁĄCZE
72T
CrV
6140



YATO	Ø	T	L (mm)	PCS packing	Box
YT-0308	3/8" (9.5 mm)	72	185	6	24/48

YATO	Ø	T	L (mm)	PCS packing	Box
YT-0311	3/8" (9.5 mm)	72	200	6	18/36

YATO	Ø	T	L (mm)	PCS packing	Box
YT-0314	3/8" (9.5 mm)	72	170	6	24/48

GB Quick release ratchet handle
D Hebelumschaltknarre
PL Grzechotka
RUS Трещотка
CZ Řehtačka
H Racsnis hajtókar

RO Dispozitiv de prindere cu clichet
F Clé à cliquet
I Cricchetto bussola
E Carraca
CN 快速脱落棘轮扳手

PLASTIC HANGER



6 PCS



COLOR BOX

3/8" 10mm

DIN 3122

QUICK RELEASE SZYBKO-ZŁĄCZE

72T

CrV 6140



YATO	Ø	T	L (mm)	PCS packing	Box
YT-0317	3/8" (9.5 mm)	72	200	6	24/48

YATO	Ø	T	L (mm)	PCS packing	Box
YT-0320	3/8" (9.5 mm)	72	205	6	24/48

YATO	Ø	T	L (mm)	PCS packing	Box
YT-0323	3/8" (9.5 mm)	72	197	6	24/48

GB Quick release ratchet handle
D Hebelumschaltknarre
PL Grzechotka
RUS Трещотка

CZ Řehtačka
H Racsnis hajtókar
RO Dispozitiv de prindere cu clichet

F Clé à cliquet
I Cricchetto bussola

E Carraca
CN 快速脱落棘轮扳手

3/8" 10mm

QUICK RELEASE SZYBKO-ZŁĄCZE

DIN 3122

72T

CrV 6140

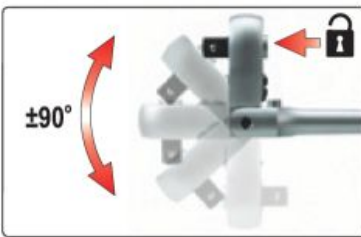

6 PCS



COLOR BOX

YATO	Ø	T	L (mm)	PCS packing	Box
YT-0326	3/8" (9.5 mm)	72	242	6	24/48

GB Quick release ratchet handle
D Hebelumschaltknarre
PL Grzechotka powlekana
RUS Трещотка
CZ Řehtačka
H Racsnis hajtókar

RO Dispozitiv de prindere cu clichet izolat
F Clé à cliquet isolée
I Cricchetto bussola isolato
E Carraca aislante
CN 绝缘棘轮扳手

PLASTIC HANGER



6 PCS



3/8" 10mm

QUICK RELEASE SZYBKO-ZŁĄCZE

DIN 3122

72T

CrV 6135



YATO	Ø	T	L (mm)	PCS packing	Box
YT-0291	3/8" (9.5 mm)	72	202	6	24/48

YATO	Ø	T	L (mm)	PCS packing	Box
YT-0294	3/8" (9.5 mm)	72	202	6	24/48

GB Insulated ratchet handle
D Hebelumschaltknarre vollisoliert
PL Grzechotka izolowana
RUS Трещотка диэлектрическая
CZ Řehtačka, izolovaná
H Racsnis hajtókar

RO Antrenor cu clichet izolat
F Clé à cliquet isolée
I Cricchetto bussola isolato
E Carraca aislante
CN 绝缘棘轮扳手



6 PCS



3/8" 10mm

QUICK RELEASE SZYBKO-ZŁĄCZE

72T

CrV 6140



POLYBAG

1000V
VDE CERTIFICATE
EN 60900:2012

YATO	Ø	T	L (mm)	PCS packing	Box
YT-21071	3/8" (9.5 mm)	36	200	6/48	

GB Quick release ratchet handle
D Hebelumschaltknarre
PL Grzechotka
RUS Трещотка
CZ Řehtačka
H Racsnis hajtókar
RO Dispozitiv de prindere cu clichet
F Clé à cliquet
I Cricchetto bussola
E Carraca
CN 快速脱落棘轮扳手



YATO	Ø	T	L (mm)	PCS packing	Box
YT-0731	3/8" (9.5 mm)	72	200	6	48

- GB Quick release ratchet handle
 D Hebelumschaltknarre
 PL Grzechotka
 RUS Трещотка
 CZ Řehtačka
 H Racsnis hajtókar
 RO Dispozitiv de prindere
 cu clichet
 F Clé à cliquet
 I Cricchetto bussola
 E Carraca
 CN 快速脱落棘轮扳手

PLASTIC HANGER
 6 PCS
 COLOR BOX
 3/8" 10mm
 QUICK RELEASE SZYBKO-ZŁĄCZE
 72T CrV 6135



YATO	Ø	T	L (mm)	PCS packing	
YT-0734	3/8" (9.5 mm)	72	200	6	24/48

- GB Telescopic ratchet handle
 D Umschaltknarre
 PL Grzechotka z przedłużanym
 uchwytem
 RUS Трещотка
 CZ Řehtačka
 H Racsnis hajtókar
 RO Antrenor cu clichet
 F Clé à cliquet
 I Cricchetto bussola
 E Carraca telescópico
 CN 可伸缩快速脱落棘轮扳手

PLASTIC HANGER
 6 PCS
 COLOR BOX
 3/8" 10mm
 QUICK RELEASE SZYBKO-ZŁĄCZE
 72T CrV 6135



YATO	Ø	T	L (mm)	PCS packing	
YT-0298	3/8" (9.5 mm)	72	215-315	6	24

- GB Hexagonal socket
 D Sechskantenschlüssel
 PL Nasadka sześciokątna
 RUS Головка шестигранная короткая
 CZ Šestihřanný nástavec
 H Hatszögű rátét
 RO Cheie tubulară hexagonală
 F Douille courte
 I Chiave a bussola esagonale
 E Boquilla hexagonal corta
 CN 六角套筒

INCREASED CONTACT AREA
 1/2" 12.5mm
 DIN 3121
 CrV 50Bv30 AS-DRIVE



- drive locks
- surface finish: chromed, satin / mirror
- zamki blokujące
- wykończenie powierzchni: chromowana, satynowa / polerowana

YATO	Ø A (mm)	D1 (mm)	D2 (mm)	L (mm)	PCS packing	
YT-1201	8	12	22	38	12	120/240
YT-1202	9	14	22	38	12	120/240
YT-1203	10	15	22	38	12	120/240
YT-1204	11	16	22	38	12	120/240
YT-1205	12	18	22	38	12	120/240
YT-1206	13	19	22	38	12	120/240
YT-1207	14	20	22	38	12	120/240
YT-1208	15	21	22	38	12	120/240
YT-1209	16	23	22	38	12	120/240
YT-1210	17	24	23	38	12	120/240
YT-1211	18	25	23	38	12	120/240
YT-1212	19	27	24	38	12	120/240
YT-1213	20	28	24	38	12	120/240
YT-1214	21	29	24	38	12	120/240
YT-1215	22	30	26	38	12	120/240
YT-1216	23	31	28	38	12	60/120
YT-1217	24	32	28	38	12	60/120
YT-1218	27	36	30	42	12	60/120
YT-1219	30	40	34	42	12	60/120
YT-1220	32	42	36	42	12	24/48

- GB Insulated hexagonal socket
 D Sechskantenschlüssel vollisoliert
 PL Nasadka sześciokątna izolowana
 RUS Головка шестигранная короткая изолированная
 CZ Šestihřanný nástavec, izolovaný
 H Hatszögű rátét hexagonală izolată
 F Douille courte isolée
 I Chiave a bussola esagonale isolato
 E Boquilla hexagonal corta aislante
 CN 绝缘六角套筒

1/2" 12.5mm
 CrV
 1000 V
 DYE



1000V
 VDE CERTIFICATE
 EN 60900:2012

YATO	Ø A (mm)	D1 (mm)	D2 (mm)	L1 (mm)	L2 (mm)	
YT-21030	10	27	19.5	55	38	12/144
YT-21031	11	27	20.7	55	38	12/144
YT-21032	12	27	22.0	55	38	12/144
YT-21033	13	27	23.2	55	38	12/144
YT-21034	14	27	24.5	55	38	12/144
YT-21036	16	27	27.0	55	38	12/144
YT-21037	17	27	28.5	55	38	12/144
YT-21038	18	27	29.5	55	38	12/144
YT-21039	19	27	30.7	55	38	12/144
YT-21041	21	27	33.2	55	38	10/110
YT-21042	22	27	34.5	55	38	10/110
YT-21044	24	27	37.0	60	38	10/110
YT-21047	27	27	38.8	60	38	6/66
YT-21050	30	27	42.8	60	38	6/66
YT-21052	32	27	44.8	60	38	6/66

GB Bi-hexagonal socket
 D Zwölfkant-Steckschlüssel-Einsatz
 PL Nasadka dwunastokątna
 RUS Головка 12-гранная
 CZ Nástrčný oheč dvanáctihřanný
 H Dugófej, 12 lapú
 RO Cheie tubulară bihexagonală
 F Douille courte
 I Chiave a bussola bi-esagonale
 E Boquilla de anillo
 CN 十二角套筒

- drive locks
- surface finish: chromed, satin / mirror
- zamki blokujące
- wykończenie powierzchni: chromowana, satynowa / polerowana

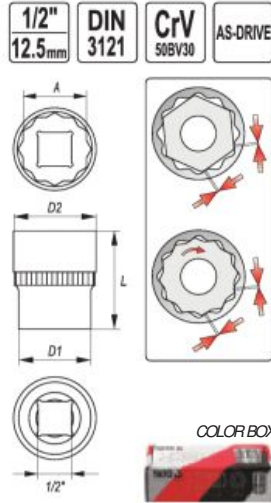

YATO	Ø A (mm)	D1 (mm)	D2 (mm)	L (mm)	PCS packing	Box
YT-1270	8	12	22	38	12	120/240
YT-1271	9	14	22	38	12	120/240
YT-1272	10	15	22	38	12	120/240
YT-1273	11	16	22	38	12	120/240
YT-1274	12	17	22	38	12	120/240
YT-1275	13	19	22	38	12	120/240
YT-1276	14	20	22	38	12	120/240
YT-1277	15	21	22	38	12	120/240
YT-1278	16	23	22	38	12	120/240
YT-1279	17	24	22	38	12	120/240
YT-1280	18	25	23	38	12	120/240
YT-1281	19	27	24	38	12	120/240
YT-1282	20	28	24	38	12	120/240
YT-1283	21	29	24	38	12	120/240
YT-1284	22	30	26	38	12	120/240
YT-1285	23	31	28	38	12	60/120
YT-1286	24	32	28	38	12	60/120
YT-1289	27	36	30	42	12	60/120
YT-1291	30	40	34	42	12	48/96
YT-1292	32	42	36	42	12	48/96

GB Spline socket
 D Steckschlüssel Spline
 PL Nasadka Spline
 RUS Головка Spline
 CZ Nástrčný klíč profil Spline
 H Spline dugófej
 RO Cheie tubulară cu stifturi
 F Douille
 I Chiave a bussola spline
 E Boquilla Spline
 CN 花键型套筒

- drive locks
- enables to undo 5 types of screws
- surface finish: chromed, satin / mirror
- zamki blokujące
- możliwość odkręcenia 5 rodzajów śrub
- wykończenie powierzchni: chromowana, satynowa / polerowana

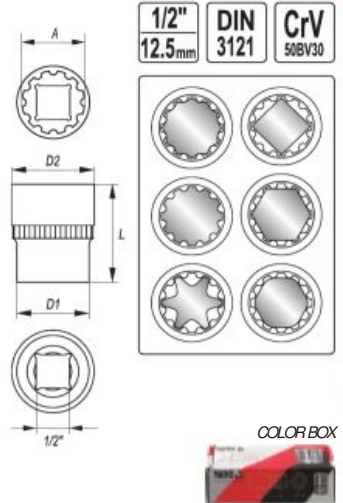

YATO	Ø A (mm)	D1 (mm)	D2 (mm)	L (mm)	PCS packing	Box
YT-1460	8	13	22	38	12	120/240
YT-1461	9	15	22	38	12	120/240
YT-1462	10	16	22	38	10	120/240
YT-1463	11	17	22	38	10	120/240
YT-1464	12	18	22	38	10	120/240
YT-1465	13	19	22	38	12	120/240
YT-1466	14	20	22	38	10	100/200
YT-1467	15	22	23	38	12	120/240
YT-1468	16	23	22	38	12	120/240
YT-1469	17	25	23	38	10	120/240
YT-1470	18	26	23	38	12	120/240
YT-1471	19	27	24	38	12	120/240
YT-1472	20	28	24	38	10	100/200
YT-1473	21	30	24	38	10	100/200
YT-1474	22	31	26	38	12	120/240
YT-1475	23	32	28	38	12	60/120
YT-1476	24	34	28	38	12	60/120
YT-1478	27	37	30	42	12	60/120
YT-1480	30	41	34	42	6	60/120
YT-1481	32	44	36	42	6	60/120

GB Hexagonal deep socket
 D Sechskantenschlüssel, lange
 PL Nasadka sześciokątna długa
 RUS Головка шестигранная длинная
 CZ Šestihranný hluboký nástavec
 H Hatszögű rátét mély
 RO Cheie tubulară hexagonală adâncă
 F Douille longue
 I Chiave a bussola bi-esagonale
 E Boquilla hexagonal larga
 CN 六角长套筒

- drive locks
- surface finish: chromed, satin / mirror
- zamki blokujące
- wykończenie powierzchni: chromowana, satynowa / polerowana

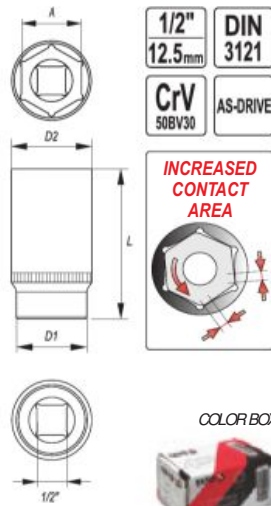

YATO	Ø A (mm)	D1 (mm)	D2 (mm)	L (mm)	PCS packing	Box
YT-1221	8	13	22	76	12	60/120
YT-1222	9	14	22	76	12	60/120
YT-1223	10	15	22	76	12	60/120
YT-1224	11	17	22	76	12	60/120
YT-1225	12	18	22	76	12	60/120
YT-1226	13	19	22	76	12	60/120
YT-1227	14	20	22	76	12	60/120
YT-1228	15	21	22	76	12	60/120
YT-1229	16	24	22	76	12	60/120
YT-1230	17	24	22	76	12	60/120
YT-1231	18	25	23	76	12	60/120
YT-1232	19	27	24	76	12	60/120
YT-1233	20	28	24	76	12	60/120
YT-1234	21	29	24	76	12	60/120
YT-1235	22	30	26	76	12	60/120
YT-1236	23	31	28	76	12	60/120
YT-1237	24	32	28	76	12	60/120
YT-1238	27	36	30	76	12	36/72
YT-1239	30	40	36	76	12	24/48
YT-1240	32	42	38	76	12	24/48

GB Bi-hexagonal deep socket
 D Zwölfkant-Steckschlüssel-Einsatz, lange
 PL Nasadka dwunastokątna długa
 RUS Головка 12-гранная длинная
 CZ Dvanáctihřanný hluboký nástavec
 H Dugófej, 12 lapú
 RO Cheie tubulară bihexagonală adâncă
 F Douille longue
 I Chiave a bussola bi-esagonale
 E Boquilla de anillo larga
 CN 十二角长套筒

- drive locks
- surface finish: chromed, satin / mirror
- zamki blokujące
- wykończenie powierzchni: chromowana, satynowa / polerowana

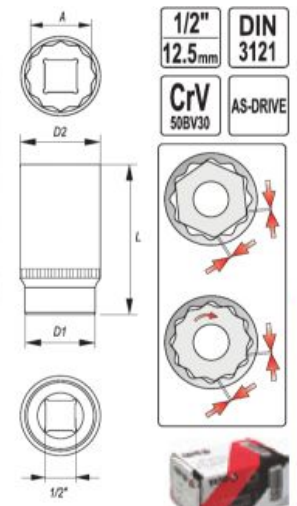

YATO	Ø A (mm)	D1 (mm)	D2 (mm)	L (mm)	PCS packing	Box
YT-12930	8	22	14	77	12	60/120
YT-12931	9	22	16	77	12	60/120
YT-12932	10	22	16	77	12	60/120
YT-12933	11	22	18	77	12	60/120
YT-12934	12	22	18	77	12	60/120
YT-12935	13	22	19	77	12	60/120
YT-12936	14	22	19	77	12	60/120
YT-12937	15	21	22	77	12	60/120
YT-12938	16	21	22	77	12	60/120
YT-12939	17	22	24	77	12	60/120
YT-12940	18	22	26	77	12	60/120
YT-12941	19	22	26	77	12	60/120
YT-12942	20	24	28	77	12	60/120
YT-12943	21	24	28	77	12	60/120
YT-12944	22	26	30	77	12	60/120
YT-12945	23	27	32	77	12	60/120
YT-12946	24	28	32	77	12	60/120
YT-12947	27	30	36	77	12	36/72
YT-12948	30	34	40	77	12	24/48
YT-12949	32	36	42	77	12	24/48

- GB Extension bar
 D Verlängerung
 PL Przedłużka
 RUS Удлинитель для воротка
 CZ Prodlužovací přípravek
 H Toldalék
 RO Prelungitor
 F Rallonge
 I Prolunga
 E Tubo de prolongación
 CN 接杆

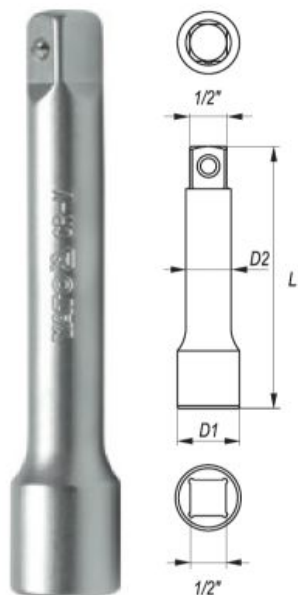

1/2"
 12.5mm
 DIN 3121
 CrV 50BV30



YATO	Ø	D1 (mm)	D2 (mm)	L (mm)	PCS packing	
YT-1246	1/2" (12.7 mm)	24.0	14.5	76	10	30/120
YT-1247	1/2" (12.7 mm)	24.0	14.5	127	5	20/80
YT-1248	1/2" (12.7 mm)	24.0	14.5	254	5	20/40

- GB Insulated extension bar
 D Verlängerung vollisoliert
 PL Przedłużka izolowana
 RUS Удлинитель для воротка для воротка
 CZ Prodlužovací přípravek, izolovaný
 H Toldalék
 RO Prelungitor izolat
 F Rallonge isolée
 I Prolunga isolato
 E Tubo de prolongación aislante
 CN 绝缘接杆



1/2"
 12.5mm
 CrV
 1000 V



1000V
 VDE CERTIFICATE
 EN 60900:2012

YATO	Ø	D1 (mm)	D2 (mm)	L1 (mm)	L2 (mm)	
YT-21057	1/2" (12.7 mm)	27	19.1	125	141	6/72
YT-21058	1/2" (12.7 mm)	27	19.1	250	266	8/32

- GB Extension bar with wobble
 D Gelenverlängerung
 PL Przedłużka uchylna
 RUS Удлинитель наклонный
 CZ Odchylný prodlužovací přípravek
 H Csuklós toldalék
 RO Prelungitor rabatabil
 F Rallonge angulaire
 I Prolunga
 E Tubo de prolongación desviable
 CN 转向接杆

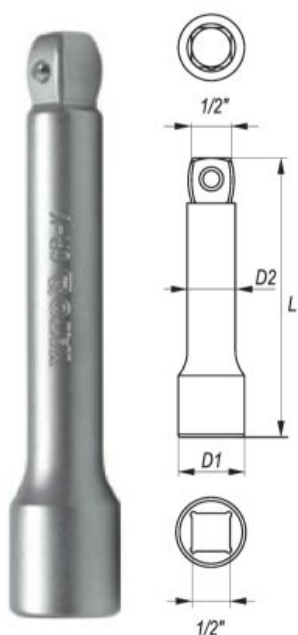

1/2"
 12.5mm
 DIN 3121
 CrV 50BV30



YATO	Ø	D1 (mm)	D2 (mm)	L (mm)	PCS packing	
YT-1249	1/2" (12.7 mm)	24.0	14.5	76	15	30/120
YT-1250	1/2" (12.7 mm)	24.0	14.5	127	5	20/80
YT-1251	1/2" (12.7 mm)	24.0	14.5	254	5	20/40

- GB Adapter
 D Reduktion
 PL Redukcja
 RUS Переходник
 CZ Redukce
 H Redukció
 RO Reducție
 F Réduction
 I Riduttore
 E Reducción
 CN 转换头

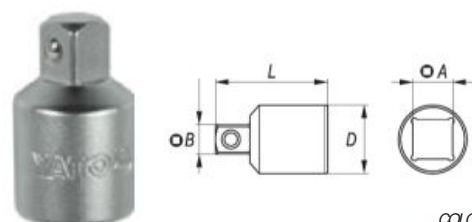

1/2" 3/4"
 12.5mm 19mm
 DIN 3121
 CrV 50BV30



YATO	Ø A	Ø B	D (mm)	L (mm)	PCS packing	
YT-1255	1/2" (12.7 mm) (F)	3/8" (9.5 mm) (M)	22	34.0	10	100/200
YT-1258	1/2" (12.7 mm) (F)	3/4" (19.0 mm) (M)	27	45.5	10	50/100
YT-1259	3/4" (19.0 mm) (F)	1/2" (12.7 mm) (M)	35	51.0	5	50/100
YT-1356	1/2" (12.7 mm) (F)	3/4" (19.0 mm) (M)	26	48.0	12	48

- GB Bit adapter
 D Bithalter
 PL Adapter do bitów
 RUS Держатель винтовёртовых наконечников
 CZ Držák na šroubovavé koncovky
 H Szár a csavarhúzóvégkehez
 RO Capete şurubelniță
 F Adapteur d'embouts
 I Chiave esagonale a bussola
 E Mandril para puntas
 CN 旋具头接头

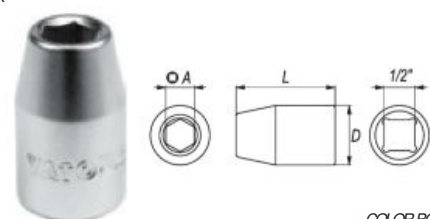

1/2"
 12.5mm
 CrV 6140



YATO	Ø	Ø A	D (mm)	L (mm)	PCS packing	
YT-1295	1/2" (12.7 mm)	8 mm	21.9	38	10	250/500

GB Universal joint
D Kardangelenk
PL Przegub Cardana
RUS Карданный шарнир
CZ Kardanový kloub
H Kardán csukló

RO Articulație Cardanică
F Cardan
I Snodo cardanico
E Articulación Cardan
CN 万向接头

1/2" 12.5mm
DIN 3121
CrV 50BV30

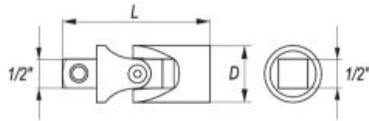

COLOR BOX

YATO	Ø	D (mm)	L (mm)	PCS packing	
YT-1252	1/2" (12.7 mm)	25	69	5	50/100

GB Sliding T-bar
D Handgriff mit Gleitstück
PL Pokręto typu „T”
RUS Вороток Т-образный

CZ Otočná ráčká typ „T”
H „T” alakú hajtókar
RO Mâner clupă tipul „T”
F Barre type „T”

I Manopola „T” scorrevole
E Mango tipo „T”
CN 滑行杆

1/2" 12.5mm

DIN 3121

CrV 50BV30

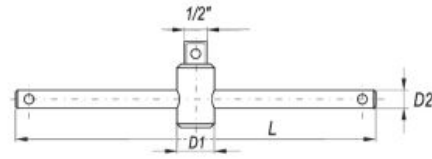

COLOR BOX

YATO	Ø	D1 (mm)	D2 (mm)	L (mm)	PCS packing	
YT-1243	1/2" (12.7 mm)	24.0	13.5	255	4	24/48

GB Flexible handle
D Gelenkgriff
PL Pokręto lamane

RUS Вороток шарнирный
CZ Otočná lomená ráčká
H Hajlított hajtókar

RO Prelungitor cu prindere flexibilă
F Barre pivotante

I Manopola a snodo
E Mango articulado
CN 转向手柄

1/2" 12.5mm

DIN 3121

CrV 50BV30

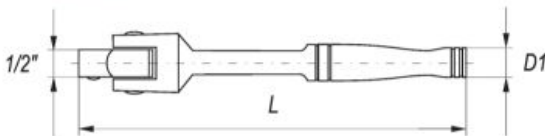

COLOR BOX

YATO	Ø	D (mm)	L (mm)	PCS packing	
YT-1241	1/2" (12.7 mm)	19	360	5	15/30
YT-1242	1/2" (12.7 mm)	20	457	5	10/20

GB L-type handle
D Admuttermsschlüssel
PL Pokręto typu „L”
RUS Вороток 1/2" тип „L”
CZ Páka zahnutá
H „L” alakú hajtókar
RO Mâner clupă tipul „L”
F Barre type „L”
I Leva tipo „L”
E Mango tipo „L”
CN L型套筒扳手

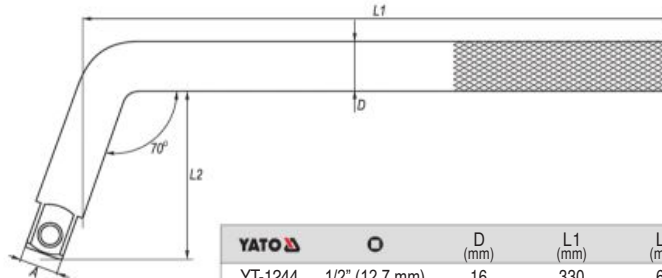

COLOR BOX

YATO	Ø	D (mm)	L1 (mm)	L2 (mm)	PCS packing	
YT-1244	1/2" (12.7 mm)	16	330	62	3	36

GB L-type handle
D Admuttermsschlüssel
PL Pokręto typu „L”
RUS Вороток 1/2" тип „L”
CZ Páka zahnutá
H „L” alakú hajtókar
RO Mâner clupă tipul „L”
F Barre type „L”
I Leva tipo „L”
E Mango tipo „L”
CN L型套筒扳手

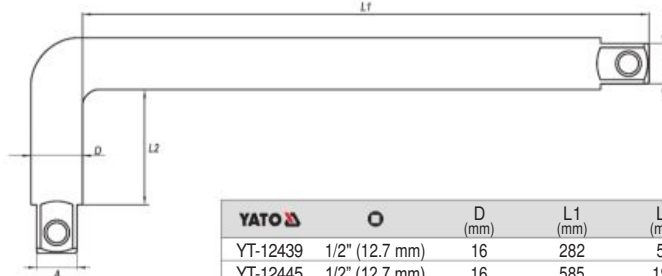

COLOR BOX

YATO	Ø	D (mm)	L1 (mm)	L2 (mm)	PCS packing	
YT-12439	1/2" (12.7 mm)	16	282	55	10	20
YT-12445	1/2" (12.7 mm)	16	585	190	2	12

GB Spark plug socket
D Steckschlüssel mit Gummihalterung
PL Nasadka do świec
RUS Головка свечная
CZ Nastavec pro svíčky
H Gyújtógyertya toldalék
RO Cheie de bujii
F Douille à bougies
I Chiavi a bussola
E Boquilla de bujías
CN 六角火花塞套筒

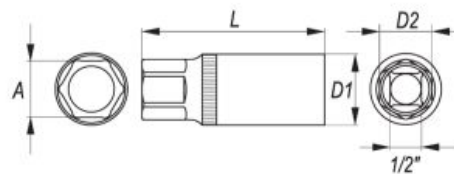

1/2" 12.5mm

DIN 3121

CrV 50BV30

AS-DRIVE

COLOR BOX

YATO	Ø	A	D1 (mm)	D2 (mm)	L (mm)	PCS packing	
YT-1253	1/2" (12.7 mm)	16.0	22.0	19.0	64.0	10	50/100
YT-1254	1/2" (12.7 mm)	21.0	27.8	24.0	64.0	10	50/100

GB Quick release ratchet handle
D Hebelumschaltknarre
PL Grzechotka
RUS Трещотка
CZ Řehtačka
H Racsnis hajtókar

RO Dispozitiv de prindere cu clichet
F Clé à cliquet
I Cricchetto bussola
E Carraca
CN 快速脱落棘轮扳手

PLASTIC HANGER



6 PCS



COLOR BOX

1/2"
12.5mm

DIN
3122

QUICK
RELEASE
SZYBKO-
ZŁĄCZE

72T

CrV
6140



YATO	Ø	T	L (mm)	PCS packing	
YT-0309	1/2" (12.7 mm)	72	278	6	24

YATO	Ø	T	L (mm)	PCS packing	
YT-0312	1/2" (12.7 mm)	72	250	6	12/24

YATO	Ø	T	L (mm)	PCS packing	
YT-0315	1/2" (12.7 mm)	72	250	6	24



YATO	Ø	T	L (mm)	PCS packing	
YT-0318	1/2" (12.7 mm)	72	250	6	24

YATO	Ø	T	L (mm)	PCS packing	
YT-0321	1/2" (12.7 mm)	72	255	6	24

YATO	Ø	T	L (mm)	PCS packing	
YT-0324	1/2" (12.7 mm)	72	265	6	24

GB Quick release ratchet handle
D Hebelumschaltknarre
PL Grzechotka
RUS Трещотка

CZ Řehtačka
H Racsnis hajtókar

I Cricchetto bussola
E Carraca
CN 快速脱落棘轮扳手

1/2"
12.5mm

QUICK
RELEASE
SZYBKO-
ZŁĄCZE

DIN
3122

72T

CrV
6140

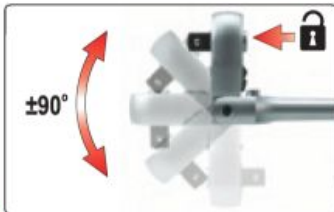

PLASTIC HANGER



6 PCS



COLOR BOX

YATO	Ø	T	L (mm)	PCS packing	
YT-0327	1/2" (12.7 mm)	72	290	6	24

GB Quick release ratchet handle
D Hebelumschaltknarre
PL Grzechotka powlekana
RUS Трещотка
CZ Řehtačka
H Racsnis hajtókar

RO Dispozitiv de prindere cu clichet
F Clé à cliquet
I Cricchetto bussola
E Carraca
CN 快速脱落棘轮扳手

PLASTIC HANGER



COLOR BOX



1/2"
12.5mm

DIN
3122

QUICK
RELEASE
SZYBKO-
ZŁĄCZE

72T

CrV
6135



YATO	Ø	T	L (mm)	PCS packing	
YT-0292	1/2" (12.7 mm)	72	257	6	24

YATO	Ø	T	L (mm)	PCS packing	
YT-0295	1/2" (12.7 mm)	72	257	6	24

GB Insulated ratchet handle
D Hebelumschaltknarre vollisoliert
PL Grzechotka izolowana
RUS Трещотка диэлектрическая
CZ Řehtačka, izolovaná
H Racsnis hajtókar
RO Antrenor cu clichet izolat
F Clé à cliquet isolée
I Cricchetto bussola isolato
E Carraca aislante
CN 绝缘棘轮扳手



1/2"
12.5mm

CrV

1000
V



POLYBAG

1000V
VDE CERTIFICATE
EN 60900:2012



YATO	Ø	T	L (mm)	PCS packing	
YT-21072	1/2" (12.7 mm)	36	250	6/36	

- GB Quick release ratchet handle
- D Hebelumschaltknarre
- PL Grzechotka
- RUS Трещотка
- CZ Řehtačka
- H Racsnis hajtókar
- RO Dispozitiv de prindere cu clichet
- F Clé à cliquet
- I Cricchetto bussola
- E Carraca
- CN 快速脱落棘轮扳手

PLASTIC HANGER

COLOR BOX

6 PCS

1/2" QUICK RELEASE SZYBKO-ZŁĄCZE 12.5mm

72T CrV 6140

- GB Quick release ratchet handle
- D Hebelumschaltknarre
- PL Grzechotka
- RUS Трещотка
- CZ Řehtačka
- H Racsnis hajtókar
- RO Dispozitiv de prindere cu clichet
- F Clé à cliquet
- I Cricchetto bussola
- E Carraca
- CN 快速脱落棘轮扳手

PLASTIC HANGER

COLOR BOX

6 PCS

1/2" QUICK RELEASE SZYBKO-ZŁĄCZE 12.5mm

72T CrV 6135



YATO	Ø	T	L (mm)	PCS packing	
YT-0732	1/2" (12.7 mm)	72	255	6	24



YATO	Ø	T	L (mm)	PCS packing	
YT-0735	1/2" (12.7 mm)	72	255	6	24

- GB Telescopic ratchet handle
- D Umschaltknarre
- PL Grzechotka z przedłużanym uchwytem
- RUS Трещотка
- CZ Řehtačka
- H Racsnis hajtókar
- RO Antrenor cu clichet
- F Clé à cliquet
- I Cricchetto bussola
- E Carraca telescópico
- CN 可伸缩快速脱落棘轮扳手



PLASTIC HANGER

COLOR BOX

6 PCS

1/2" QUICK RELEASE SZYBKO-ZŁĄCZE 12.5mm

72T CrV 6135

YATO	Ø	T	L (mm)	PCS packing	
YT-0299	1/2" (12.7 mm)	72	305-445	6	24

- GB Flexible ratchet handle / round head
- D Flexible Drehkopfratsche
- PL Grzechotka z obrotową głowicą
- RUS Трещотка с вращательной головкой
- CZ Ráčna s otočnou hlavou
- H Forgófejes racsnis szár
- RO Antrenor cu clichet flexibil
- F Clé à cliquet tête pivotante
- I Cricchetto bussola reversibile con ghiera
- E Carraca con cabeza giratoria
- CN 旋转头快速脱落棘轮扳手



PLASTIC HANGER

COLOR BOX

6 PCS

1/2" QUICK RELEASE SZYBKO-ZŁĄCZE 12.5mm

72T CrV 6140

YATO	Ø	T	L (mm)	PCS packing	
YT-0722	1/2" (12.7 mm)	72	280	6	30

- GB Internal ratchet wrench
- D Innenratschenschlüssel
- PL Grzechotka wewnętrzna
- RUS Трещотка внутренняя
- CZ Radiátorový klíč s ráčnou
- H Lépcsős kulcskészlet racsnival
- RO Cheie robinet radiator
- F Clé de montage étagee
- I Cricchetto di tipo interno
- E Llave carraca radiadores
- CN 穿心棘轮扳手

1/2" QUICK RELEASE SZYBKO-ZŁĄCZE 12.5mm

CrV 30T



for / dla: YT-03315

TIED ON CARD

YATO	Ø	
YT-03315	1/2" (12.7 mm)	6/24

- GB Step wrench
- D Stufenschlüssel
- PL Klucz stopniowy
- RUS Калибратор FORA для металлопластиковых труб
- CZ Klíč na radiátorové šroubení
- H Lépcsős radiátor kulcs
- RO Cheie in trepte pt. radiator
- F Clé de montage étagee
- I Chiave a cricco
- E Llave de radiadores
- CN 散熱六角階梯扳手

1/2" QUICK RELEASE SZYBKO-ZŁĄCZE 12.5mm

3/8" 29/64" 1/2" 21/32" 27/32"

9.6 mm 11.6 mm 12.6 mm 16.4 mm 21 mm

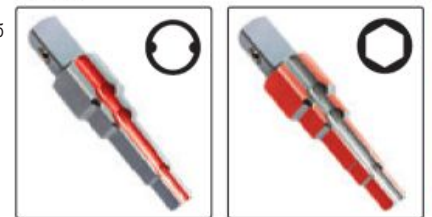

for / dla: YT-03315

POLYBAG WITH HEADER

YATO	Ø	
YT-03316	1/2" (12.7 mm)	100

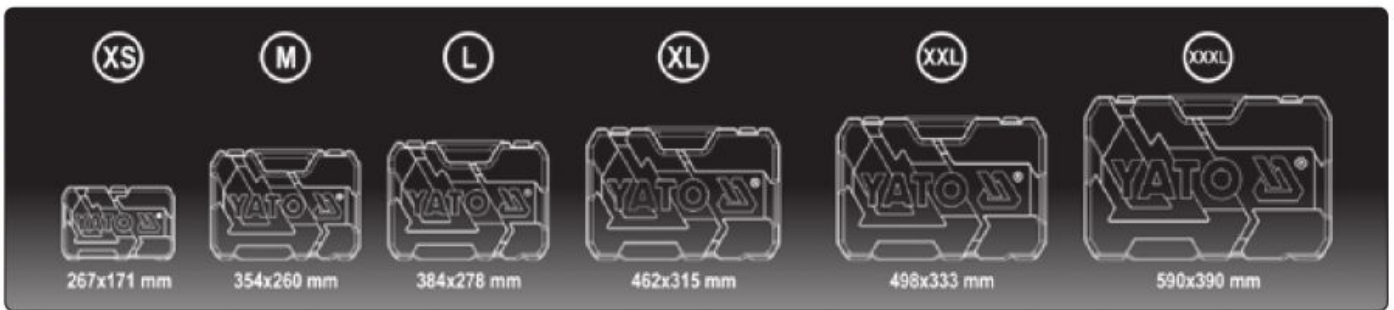

GB Socket set

D Sechskant-Steckschlüssel-Satz

PL Komplet nasadek dlugich

RUS Набор насадок

CZ Sada nástrčných klíčů

H Dugókulcs készlet

RO Trusa de scule

F Set de douilles longues

I Serie di chiavi a bussola lunghi

E Juego de herramientas

CN 长套筒组套



GB Tool set

D Sechskant-Steckschlüssel- Satz

PL Zestaw narzędziowy

RUS Набор инструмента

CZ Sada nástrčných klíčů a ráčny

H Dugókulcs készlet racsnis hajtókarral

RO Trusa de scule

F Coffret d'outillage

I Set di utensili

E Juego

de herramientas

CN 套筒扳手组套



1/4" (6.3 mm): 5.5, 6, 7, 8, 9, 10, 12, 13 mm (L=50 mm); CrV 50BV30

PLASTIC HANGER



1/4" (6.3 mm): 3.5, 4, 4.5, 5, 5.5, 6, 7, 8, 9, 10, 11, 12, 13, 14 mm (L=25 mm); CrV 50BV30;
1/4" (6.3 mm); (51.6, 151.5 mm); CrV 50BV30;
1/4" (6.3 mm); CrV 50BV30;
1/4" (6.3 mm); (152.8 mm); CrV 50BV30;
1/4" (6.3 mm); (155 mm); 72T; CrMo 440;
1/4" (6.3 mm); (150 mm); CrV 50BV30

BMC & COLOR SLEEVE XS SIZE



YATO		
YT-14431	1/4" (6.3 mm)	10/20

YATO		
YT-14491	1/4" (6.3 mm)	10

GB Tool set

D Sechskant-Steckschlüssel-Satz

PL Zestaw narzędziowy

RUS Набор инструмента

CZ Sada nástrčných klíčů a ráčny

H Dugókulcs készlet racsnis hajtókarral

RO Trusa de scule

F Coffret d'outillage

I Set di utensili

E Juego de herramientas

CN 套筒扳手组套

BMC & COLOR SLEEVE XS SIZE



23 PCS 1/4" (6.3 mm): 4, 5, 6, 7, 8, 9, 10, 12, 13 mm (L=25 mm); CrV 50BV30;
1/4" (6.3 mm): 4, 5, 6, 7, 8, 9, 10, 12, 13 mm (L=50 mm); CrV 50BV30;
1/4" (6.3 mm); (50.8, 152.4 mm); CrV 50BV30;
1/4" (6.3 mm); CrV 50BV30;
1/4" (6.3 mm); (155 mm); 72T; CrMo 440;
1/4" (6.3 mm); (150 mm); CrV 50BV30

25 PCS 1/4" (6.3 mm): 3.5, 4, 4.5, 5, 5.5, 6, 7, 8, 9, 10, 11, 12, 13, 14 mm (L=25 mm); CrV 50BV30;
1/4" (6.3 mm): 8, 10, 11, 12, 13 mm (L=50 mm); CrV 50BV30;
1/4" (6.3 mm); (50.8, 101.6 mm); CrV 50BV30;
1/4" (6.3 mm); CrV 50BV30;
1/4" (6.3 mm); (152.4 mm); CrV 40;
1/4" (6.3 mm); (155 mm); 72T; CrMo 440;
1/4" (6.3 mm); (150 mm); CrV 50BV30

YATO		
YT-14451	1/4" (6.3 mm)	10

YATO		
YT-14461	1/4" (6.3 mm)	10

GB Tool set
 D Sechskant-Steckschlüssel-Satz
 PL Zestaw narzędziowy
 RUS Набор инструмента

CZ Sada nástrčných klíčů a ráčny
 H Dugókulcs készlet racsnis hajtókarral
 RO Trusa de scule
 F Coffret d'outillage

I Set di utensili
 E Juego de herramientas
 CN 套筒扳手组套

BMC & COLOR SLEEVE
 XS SIZE



1/4" 6.3mm	CrV 50BV30	CrV 6150	CrV 40
CrMo 440	S2	72T	AS-DRIVE

2



38
PCS

- 1/4" (6.3 mm): 3.5, 4, 4.5, 5, 5.5, 6, 7, 8, 9, 10, 11, 12, 13, 14 mm (L=25 mm); CrV 50BV30;
- 1/4" (6.3 mm); (50.8, 101.6 mm); CrV 50BV30;
- 1/4" (6.3 mm); CrV 50BV30;
- 1/4" (6.3 mm); (152.4 mm); CrV 40;
- 1/4" (6.3 mm); (155 mm); 72T; CrMo 440;
- 1/4" (6.3 mm); (150 mm); CrV 50BV30;
- 1/4" (6.3 mm): 4, 5.5, 6.5 mm (L=37 mm); AISI S2 / CrV 6150;
- 1/4" (6.3 mm): PH1, PH2 (L=37 mm); AISI S2 / CrV 6150;
- 1/4" (6.3 mm): PZ1, PZ2 (L=37 mm); AISI S2 / CrV 6150;
- 1/4" (6.3 mm): T10, T15, T20, T25, T30, T40 (L=37 mm); AISI S2 / CrV 6150;
- 1/4" (6.3 mm): 3, 4, 5, 6, 8 mm (L=37 mm); AISI S2 / CrV 6150

YATO		
YT-14471	1/4" (6.3 mm)	10



42
PCS

- 1/4" (6.3 mm): 4, 4.5, 5, 5.5, 6, 7, 8, 9, 10, 11, 12, 13, 14 mm (L=25 mm); CrV 50BV30;
- 1/4" (6.3 mm): 8, 9, 10, 11, 12, 13 mm (L=50 mm); CrV 50BV30;
- 1/4" (6.3 mm); (50.8, 101.6 mm); CrV 50BV30;
- 1/4" (6.3 mm); (150 mm); CrV 50BV30;
- 1/4" (6.3 mm); CrV 50BV30;
- 1/4" (6.3 mm); (152.4 mm); CrV 40;
- 1/4" (6.3 mm); (155 mm); 72T; CrMo 440;
- 1/4" (6.3 mm); (150 mm); CrV 50BV30;
- 1/4" (6.3 mm) x 1/4" (6.3 mm); CrV 50BV30;
- 1/4" (6.3 mm): 3, 4, 5 mm (L=25 mm); AISI S2;
- 1/4" (6.3 mm): PH0, PH1, PH2 (L=25 mm); AISI S2;
- 1/4" (6.3 mm): PZ0, PZ1, PZ2 (L=25 mm); AISI S2;
- 1/4" (6.3 mm): 6, 7, 8 mm (L=25 mm); AISI S2;
- 1.5, 2.0, 2.5 mm; CrV 6150

YATO		
YT-14481	1/4" (6.3 mm)	6



56
PCS

- 1/4" (6.3 mm): 4, 4.5, 5, 5.5, 6, 7, 8, 9, 10, 11, 12, 13 mm (L=25 mm); CrV 50BV30;
- 1/4" (6.3 mm): 6, 7, 8, 9, 10, 11, 12, 13 mm (L=50 mm); CrV 50BV30;
- 1/4" (6.3 mm): E4, E5, E6, E7, E8, E10; CrV 6150;
- 1/4" (6.3 mm); (76, 152.4 mm); CrV 50BV30;
- 1/4" (6.3 mm); (150 mm); CrV 50BV30;
- 1/4" (6.3 mm); CrV 50BV30;
- 1/4" (6.3 mm); (152.4 mm); CrV 40;
- 1/4" (6.3 mm); (155 mm); 72T; CrMo 440;
- 1/4" (6.3 mm); (150 mm); CrV 50BV30;
- 1/4" (6.3 mm) (F) x 3/8" (9.5 mm) (M); CrV 50BV30;
- 1/4" (6.3 mm): 4, 5.5, 6.5 mm (L=37 mm); AISI S2 / CrV 6150;
- 1/4" (6.3 mm): PH1, PH2, PH3 (L=37 mm); AISI S2 / CrV 6150;
- 1/4" (6.3 mm): PZ1, PZ2, PZ3 (L=37 mm); AISI S2 / CrV 6150;
- 1/4" (6.3 mm): T8, T10, T15, T20, T25, T30, T40 (L=37 mm); AISI S2 / CrV 6150;
- 1/4" (6.3 mm): 3, 4, 5, 6, 7, 8 mm (L=37 mm); AISI S2 / CrV 6150

YATO		
YT-14501	1/4" (6.3 mm)	10

GB Tool set
 D Sechskant-Steckschlüssel-Satz
 PL Zestaw narzędziowy

RUS Набор инструмента
 CZ Sada nástrčných klíčů a ráčny
 H Dugókulcs készlet racsnis hajtókarral

RO Trusa de scule
 F Coffret d'outillage
 Set di utensili

E Juego de herramientas
 CN 套筒扳手组套

22 PCS	3/8" 10mm	CrV 50BV30	CrV 40
CrMo 440	72T	AS-DRIVE	



- 3/8" (9.5 mm): 6, 7, 8, 9, 10, 11, 12, 13, 14, 15, 16 mm (L=28 mm); 17, 18, 19, 20, 21, 22 mm (L=30 mm); CrV 50BV30;
- 3/8" (9.5 mm); (76, 152.4 mm); CrV 50BV30;
- 3/8" (9.5 mm); CrV 50BV30;
- 3/8" (9.5 mm); (198 mm); CrV 40;
- 3/8" (9.5 mm); (200 mm); 72T; CrMo 440

BMC & COLOR SLEEVE
 XS SIZE



YATO	3/8" (9.5 mm)	10
YT-38561		

GB Socket set
 D Sechskant-Steckschlüssel-Satz
 PL Komplet nasadek długich
 RUS Набор насадок

CZ Sada nástrčných klíčů
 H Dugókulcs készlet
 RO Trusa de scule
 F Set de douilles longues

I Serie di chiavi a bussola lunghi
 E Juego de herramientas
 CN 长套筒组套

PLASTIC HANGER



10 PCS	1/2" 12.5mm	CrV 50BV30	AS-DRIVE
-----------	----------------	---------------	----------



- 1/2" (12.7 mm): 10, 12, 13, 14, 15, 17, 19, 21, 22, 24 mm (L=76 mm); CrV 50BV30

YATO	1/2" (12.7 mm)	10
YT-38861		

GB Socket set
 D Sechskant-Steckschlüssel-Einsatz
 PL Komplet nasadek z akcesoriami
 RUS Набор торцевых головок

CZ Sada nástrčných klíčů a ráčny
 H Dugókulcs készlet racsnis hajtókarral
 RO Trusa de scule
 F Set de douilles + accessoires

I Serie di chiavi a con accessori
 E Juego de boquillas con accesorios
 CN 套筒扳手组套

PLASTIC HANGER



12 PCS	1/2" 12.5mm	CrV 50BV30	AS-DRIVE
CrMo 440	72T		



- 1/2" (12.7 mm): 10, 11, 12, 13, 14, 15, 17, 19, 21, 24 mm (L=38 mm); CrV 50BV30;
- 1/2" (12.7 mm); (127 mm); CrV 50BV30;
- 1/2" (12.7 mm); (255 mm); 72T; CrMo 440

YATO	1/2" (12.7 mm)	5/10
YT-38821		

GB Ratchet handle with socket set
 D Sechskant-Steckschlüssel-Satz
 PL Komplet nasadek z grzechotką
 RUS Набор насадок

CZ Sada nástrčných klíčů a ráčny
 H Dugókulcs készlet racsnis hajtókarral
 RO Trusa de scule
 F Clé mixte à cliquet + douilles

I Serie di chiavi con cricchetto
 E Matraca con boquillas
 CN 套筒扳手组套

PLASTIC HANGER



19 PCS	1/2" 12.5mm	CrV 50BV30	AS-DRIVE
CrMo 440	72T		



- 1/2" (12.7 mm): 8, 9, 10, 11, 12, 13, 14, 15, 16, 17, 19, 21, 22, 23, 24 mm (L=38 mm); 27, 30, 32 mm (L=42 mm); CrV 50BV30;
- 1/2" (12.7 mm); (255 mm); 72T; CrMo 440

YATO	1/2" (12.7 mm)	3/6
YT-38681		

GB Tool set
 D Sechskant-Steckschlüssel-Satz
 PL Zestaw narzędziowy

RUS Набор инструмента
 CZ Sada nástrčných klíčů a ráčny
 H Dugókulcs készlet racsnis hajtókarral

RO Trusa de scule
 F Coffret d'outillage
 Set di utensili

E Juego de herramientas
 CN 套筒扳手组套

12 PCS	1/2" 12.5mm	CrV 50BV30	AS-DRIVE
CrMo 440	72T		



- 1/2" (12.7 mm): 10, 11, 12, 13, 14, 15, 17, 19, 21, 24 mm (L=38 mm); CrV 50BV30;
- 1/2" (12.7 mm); (127 mm); CrV 50BV30;
- 1/2" (12.7 mm); (255 mm); 72T; CrMo 440

BMC & COLOR SLEEVE
 XS SIZE



YATO	1/2" (12.7 mm)	10
YT-38671		

GB Tool set
D Sechskant-Steckschlüssel-Satz
PL Zestaw narzędziowy

RUS Набор инструмента
CZ Sada nástrčných klíčů a ráčny
H Dugókulcs készlet racsnis hajtókarral

RO Trusa de scule
F Coffret d'outillage
I Set di utensili

E Juego de herramientas
CN 套筒扳手组套

BMC & COLOR SLEEVE
L SIZE



1/2" CrV 50BV30
12.5mm CrV 6140
72T
AS-DRIVE

2



20
PCS

- 1/2" (12.7 mm): 10, 11, 12, 13, 14, 15, 16, 17, 18, 19, 22, 24 mm (L=38 mm); CrV 50BV30;
- 1/2" (12.7 mm): 13, 17, 19 mm (L=76 mm); CrV 50BV30;
- 1/2" (12.7 mm); (254 mm); CrV 50BV30;
- 3/8" (9.5 mm) (F) x 1/2" (12.7 mm) (M); CrV 50BV30;
- 1/2" (12.7 mm); CrV 50BV30;
- 1/2" (12.7 mm): 16 mm; CrV 50BV30;
- 1/2" (12.7 mm): (255 mm); 72T; CrV 6140

YATO		
YT-38691	1/2" (12.7 mm)	6



25
PCS

- 1/2" (12.7 mm): 10, 11, 12, 13, 14, 15, 16, 17, 18, 19, 20, 21, 22, 23, 24 mm (L=38 mm); 27, 30, 32 mm (L=42 mm);
- 1/2" (12.7 mm); (127 mm); CrV 50BV30;
- 1/2" (12.7 mm): 16, 21 mm; CrV 50BV30;
- 1/2" (12.7 mm); (255 mm); CrV 50BV30;
- 1/2" (12.7 mm); (255 mm);
- 1/2" (12.7 mm); (317 mm); CrV 50BV30;
- 1/2" (12.7 mm) (F) x 3/8" (9.5 mm) (M); CrV 50BV30

YATO		
YT-38741	1/2" (12.7 mm)	2

GB Tool set
D Sechskant-Steckschlüssel-Satz
PL Zestaw narzędziowy

RUS Набор инструмента
CZ Sada nástrčných klíčů a ráčny
H Dugókulcs készlet racsnis hajtókarral

RO Trusa de scule
F Coffret d'outillage
I Set di utensili

E Juego de herramientas
CN 套筒扳手组套

1/2" 1/4"
12.5mm 6.3mm
CrV 50BV30 S2
72T AS-DRIVE

BMC & COLOR SLEEVE
L SIZE



77
PCS CrV 6150 CrMo 440

- 1/2" (12.7 mm): 10, 11, 12, 13, 14, 15, 17, 19, 22, 24 mm (L=38 mm); 27, 30, 32 mm (L=42 mm);
- 1/4" (6.3 mm): 4, 5, 6, 7, 8, 9, 10, 11, 12 mm (L=25 mm); CrV 50BV30;
- 1/2" (12.7 mm); (127, 254 mm);
- 1/4" (6.3 mm); (76, 101.6 mm); CrV 50BV30;
- 1/2" (12.7 mm), 1/4" (6.3 mm); CrV 50BV30;
- 1/2" (12.7 mm): 16, 21 mm; CrV 50BV30;
- 1/2" (12.7 mm); (255 mm);
- 1/4" (6.3 mm); (155 mm); 72T; CrMo 440;
- 1/4" (6.3 mm) x 1/4" (6.3 mm); CrV 50BV30;
- 1/4" (6.3 mm) x 1/4" (6.3 mm); CrV 50BV30;
- 1/4" (6.3 mm): 3, 4, 5.5, 7 mm (L=25 mm); AISI S2;
- 1/4" (6.3 mm): PH0, PH1, PH2, PH3 (L=25 mm); AISI S2;
- 1/4" (6.3 mm): PZ1, PZ2, PZ3 (L=25 mm); AISI S2;
- 1/4" (6.3 mm): T10, T15, T20, T25, T30 (L=25 mm); AISI S2;
- 1/4" (6.3 mm): 2, 3, 4, 5, 6 mm (L=25 mm); AISI S2;
- 7, 8, 9, 10, 11, 12, 13, 14, 15, 17, 19 mm; CrV;
- 8x9, 10x11, 12x13, 14x15 mm; CrV 50BV30;
- 1.5, 2, 2.5, 5, 6, 8, 10 mm; CrV 6150

YATO		
YT-38781	1/2" (12.7 mm)	1/4" (6.3 mm)
		2

GB Tool set
D Sechskant-Steckschlüssel-Satz
PL Zestaw narzędziowy
RUS Набор инструмента

CZ Sada nástrčných kľúčů a ráčny
H Dugókulcs készlet racsnis hajtókarral
RO Trusa de scule
F Coffret d'outillage

I Set di utensili
E Juego de herramientas
CN 套筒扳手组套

1/2" 12.5mm
1/4" 6.3mm
CrV 50BV30 S2
72T AS-DRIVE

BMC & COLOR SLEEVE
XXXL SIZE



79 PCS CrV 6140 CrV 60 CrMo SK5

- 1/2" (12.7 mm): 10, 11, 12, 13, 14, 16, 17, 19, 22, 24, 26 mm (L=38 mm); 27, 30, 32 mm (L=42 mm);
- 1/4" (6.3 mm): 5, 6, 7, 8, 9, 10, 11, 12, 13 mm (L=25 mm); CrV 50BV30;
- 1/2" (12.7 mm): 10, 11, 12, 13, 14, 17, 19 mm (L=76 mm); CrV 50BV30;
- 1/2" (12.7 mm); (125 mm);
- 1/4" (6.3 mm); (50 mm); CrV 50BV30;
- 1/2" (12.7 mm); CrV 50BV30;
- 1/2" (12.7 mm): 16, 21 mm; CrV 50BV30;
- 1/2" (12.7 mm); (255 mm);
- 1/4" (6.3 mm); (155 mm); 72T; CrV 6140;
- 1/4" (6.3 mm); (150 mm); CrV 50BV30;
- 1/2" (12.7 mm); (457 mm);
- 6, 7, 8, 9, 10, 11, 12, 13, 14, 16, 17, 19, 22, 24 mm; CrV;
- 2.0x50, 2.4x75 mm, S2;
- 3.0x75, 4.0x100, 6.5x150, 8.0x150 mm; S2;
- PH0x75 mm; S2; PH1x75, PH2x100 mm; S2;
- 180 mm; 160 mm;
- 160, 200 mm; 250 mm;
- 300 g; 300 mm;
- 180 mm; CrMo; 120 mm; CrV 60;
- SK5; 2.5, 3, 4, 5, 6, 8, 10 mm; CrV

YATO	1/2" (12.7 mm)	1/4" (6.3 mm)	2
YT-38911			



BMC & COLOR SLEEVE
L SIZE



82 PCS CrV 6150 CrV 40 CrMo 440

- 1/2" (12.7 mm): 14, 15, 16, 17, 18, 19, 20, 22, 24 mm (L=38 mm); 27, 30, 32 mm (L=42 mm); 1/4" (6.3 mm): 4, 4.5, 5, 5.5, 6, 7, 8, 9, 10, 11, 12, 13, 14 mm (L=25 mm); CrV 50BV30; 1/2" (12.7 mm); (127, 254 mm); 1/4" (6.3 mm); (50.8, 101.6 mm); CrV 50BV30; 3/8" (9.5 mm) (F) x 1/2" (12.7 mm) (M); CrV 50BV30; 1/4" (6.3 mm); (150 mm); CrV 50BV30; 1/2" (12.7 mm); 1/4" (6.3 mm); CrV 50BV30;
- 1/2" (12.7 mm): 16, 21 mm; CrV 50BV30; 1/4" (6.3 mm); (152.4 mm);
- 1/2" (12.7 mm); 1/2" (12.7 mm); (255 mm); 1/4" (6.3 mm); (155 mm); 72T; CrMo 440; 1/4" (6.3 mm); (150 mm); CrV 50BV30; 1/2" (12.7 mm) x 5/16" (7.9 mm); CrV 50BV30; 1/4" (6.3 mm) x 1/4" (6.3 mm); CrV 50BV30;
- 5/16" (7.9 mm): 8, 10, 12 mm (L=30 mm); AISI S2; 5/16" (7.9 mm): PH3, PH4 (L=30 mm); AISI S2; 5/16" (7.9 mm): PZ3, PZ4 (L=30 mm); AISI S2;
- 5/16" (7.9 mm): T40, T45, T50, T55 (L=30 mm); AISI S2; 5/16" (7.9 mm): 8, 10, 12, 14 mm (L=30 mm); AISI S2; 1/4" (6.3 mm): 4, 5.5, 7 mm (L=37 mm); AISI S2 / CrV 6150; 1/4" (6.3 mm): PH1, PH2 (L=37 mm); AISI S2 / CrV 6150;
- 1/4" (6.3 mm): PZ1, PZ2 (L=37 mm); AISI S2 / CrV 6150; 1/4" (6.3 mm): T8, T10, T15, T20, T25, T30 (L=37 mm); AISI S2 / CrV 6150;
- 8, 10, 11, 12, 13, 14, 17, 19, 22 mm; CrV

YATO	1/2" (12.7 mm)	1/4" (6.3 mm)	2
YT-12691			

GB Tool set
D Sechskant-Steckschlüssel-Satz
PL Zestaw narzędziowy
RUS Набор инструмента

CZ Sada nástrčných klíčů a ráčny
H Dugókulcs készlet racsnis hajtókarral
RO Trusa de scule
F Coffret d'outillage

I Set di utensili
E Juego de herramientas
CN 套筒扳手套

BMC & COLOR SLEEVE
L SIZE



1/2" 12.5mm	1/4" 6.3mm
CrV 50BV30	S2
72T	AS-DRIVE

2



94 PCS	CrV 6150	CrV 40	CrMo 440
-----------	-------------	-----------	-------------

1/2" (12.7 mm): 10, 11, 12, 13, 14, 15, 16, 17, 18, 19, 20, 21, 22, 23, 24 mm (L=38 mm); 27, 30, 32 mm (L=42 mm); 1/4" (6.3 mm): 4, 4.5, 5, 5.5, 6, 7, 8, 9, 10, 11, 12, 13, 14 mm (L=25 mm); CrV 50BV30; 1/2" (12.7 mm): 14, 15, 17, 19 mm (L=76 mm); 1/4" (6.3 mm): 6, 7, 8, 9, 10, 11, 12, 13 mm (L=50 mm); CrV 50BV30; 1/2" (12.7 mm): (127, 254 mm), 1/4" (6.3 mm): (50.8, 101.6 mm); CrV 50BV30; 3/8" (9.5 mm) (F) x 1/2" (12.7 mm) (M); CrV 50BV30; 1/4" (6.3 mm): (150 mm); CrV 50BV30; 1/2" (12.7 mm), 1/4" (6.3 mm); CrV 50BV30; 1/2" (12.7 mm): 16, 21 mm; CrV 50BV30; 1/4" (6.3 mm); (152.4 mm); CrV 40; 1/2" (12.7 mm); (255 mm), 1/4" (6.3 mm); (155 mm); 72T; CrMo 440; 1/4" (6.3 mm); (150 mm); CrV 50BV30; 1/2" (12.7 mm) x 5/16" (7.9 mm); CrV 50BV30; 1/4" (6.3 mm) x 1/4" (6.3 mm); CrV 50BV30; 5/16" (7.9 mm): 8, 10, 12 mm (L=30 mm); AISI S2; 5/16" (7.9 mm): PH3, PH4 (L=30 mm); AISI S2; 5/16" (7.9 mm): PZ3, PZ4 (L=30 mm); AISI S2; 5/16" (7.9 mm): T40, T45, T50, T55 (L=30 mm); AISI S2; 5/16" (7.9 mm): 8, 10, 12, 14 mm (L=30 mm); AISI S2; 1/4" (6.3 mm): 4, 5.5, 7 mm (L=37 mm); AISI S2 / CrV 6150; 1/4" (6.3 mm): PH1, PH2 (L=37 mm); AISI S2 / CrV 6150; 1/4" (6.3 mm): PZ1, PZ2 (L=37 mm); AISI S2 / CrV 6150; 1/4" (6.3 mm): T8, T10, T15, T20, T25, T30 (L=37 mm); AISI S2 / CrV 6150; 1/4" (6.3 mm): 3, 4, 5, 6 mm (L=37 mm); AISI S2 / CrV 6150; 1.5, 2, 2.5 mm; CrV 6150

YATO			
YT-12681	1/2" (12.7 mm)	1/4" (6.3 mm)	2



100 PCS	CrV 6140
------------	-------------

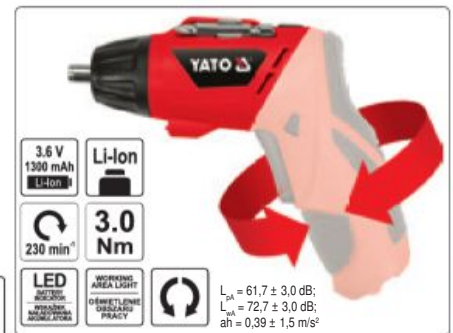

3.6V
1300 mAh
Li-Ion

230 min*

3.0 Nm

LED
WORKING AREA LIGHT
MAGNETIC DRIVE
DEBETLENE
ODKŁADKI
PRACY

L_{WA} = 61.7 ± 3.0 dB;
L_{WA} = 72.7 ± 3.0 dB;
ah = 0.39 ± 1.5 m/s²

1/2" (12.7 mm): 10, 11, 12, 13, 14, 15, 16, 17, 18, 19, 20, 21, 22, 23, 24 mm (L=38 mm); 27, 30, 32 mm (L=42 mm); 1/4" (6.3 mm): 4, 4.5, 5, 5.5, 6, 7, 8, 9, 10, 11, 12, 13, 14 mm (L=25 mm); CrV 50BV30; 1/4" (6.3 mm): 6, 7, 8, 9, 10, 11, 12, 13 mm (L=50 mm); CrV 50BV30; 1/2" (12.7 mm): (127, 254 mm), 1/4" (6.3 mm): (50.8, 101.6 mm); CrV 50BV30; 3/8" (9.5 mm) (F) x 1/2" (12.7 mm) (M); CrV 50BV30; 1/4" (6.3 mm): (150 mm); CrV 6140; 1/2" (12.7 mm), 1/4" (6.3 mm); CrV 50BV30; 1/2" (12.7 mm): 16, 21 mm; CrV 50BV30; 1/4" (6.3 mm); (152.4 mm); CrV 50BV30; 1/2" (12.7 mm); (255 mm), 1/4" (6.3 mm); (155 mm); 72T; CrV 6140; 1/4" (6.3 mm); (150 mm); CrV 50BV30; 1/2" (12.7 mm) x 5/16" (7.9 mm); CrV 6140; 1/4" (6.3 mm) x 1/4" (6.3 mm); CrV 6140; 5/16" (7.9 mm): 8, 10, 12 mm (L=30 mm); AISI S2; 5/16" (7.9 mm): PH3, PH4 (L=30 mm); AISI S2; 5/16" (7.9 mm): PZ3, PZ4 (L=30 mm); AISI S2; 5/16" (7.9 mm): T40, T45, T50, T55 (L=30 mm); AISI S2; 5/16" (7.9 mm): 8, 10, 12, 14 mm (L=30 mm); AISI S2; 1/4" (6.3 mm): 4 mm (L=50 mm); AISI S2, 1/4" (6.3 mm): 3, 4, 5, 5.5, 7 mm (L=25 mm); AISI S2; 1/4" (6.3 mm): PH1 (L=50 mm); AISI S2, 1/4" (6.3 mm): PH0, PH1, PH2, PH3 (L=25 mm); AISI S2; 1/4" (6.3 mm): PZ1, PZ2, PZ3 (L=25 mm); AISI S2; 1/4" (6.3 mm): T10, T15, T20, T25, T30 (L=25 mm); AISI S2; 1/4" (6.3 mm): 2, 3, 4, 5, 6 mm (L=25 mm); AISI S2; 3.6V; 5V 300mA; 1.5, 2.0, 2.5 mm; CrV 6150

YATO			
YT-12685	1/2" (12.7 mm)	1/4" (6.3 mm)	2

GB Tool set
D Sechskant-Steckschlüssel-Satz
PL Zestaw narzędziowy
RUS Набор инструмента

CZ Sada nástrčných klíčů a ráčny
H Dugókulcs készlet racsni hajtókarral
RO Trusa de scule
F Coffret d'outillage

I Set di utensili
E Juego de herramientas
CN 套筒扳手组套

1/2" 12.5mm	1/4" 6.3mm
CrV 50BV30	CrV 6150
CrMo 440	S2
72T	AS-DRIVE

2



BMC & COLOR SLEEVE
L SIZE



108
PCS

CrV
40

1/2" (12.7 mm): 10, 11, 12, 13, 14, 15, 16, 17, 18, 19, 20, 21, 22, 24 mm (L=38 mm); 27, 30, 32 mm (L=42 mm), 1/4" (6.3 mm): 4, 4.5, 5, 5.5, 6, 7, 8, 9, 10, 11, 12, 13, 14 mm (L=25 mm); CrV 50BV30; 1/2" (12.7 mm): 14, 15, 17, 19, 22 mm (L=76 mm), 1/4" (6.3 mm): 6, 7, 8, 9, 10, 11, 12, 13 mm (L=50 mm); CrV 50BV30; 1/2" (12.7 mm): E10, E11, E12, E14, E16, E18, E20, E24, 1/4" (6.3 mm): E4, E5, E6, E7, E8; CrV 6150; 1/2" (12.7 mm): (127, 254 mm), 1/4" (6.3 mm): (50.8, 101.6 mm); CrV 50BV30; 3/8" (9.5 mm) (F) x 1/2" (12.7 mm) (M); CrV 50BV30; 1/2" (12.7 mm), 1/4" (6.3 mm); CrV 50BV30; 1/2" (12.7 mm): 16, 21 mm; CrV 50BV30; 1/4" (6.3 mm); (152.4 mm); CrV 40; 1/2" (12.7 mm); (255 mm), 1/4" (6.3 mm); (155 mm); 72T; CrMo 440; 1/4" (6.3 mm); (150 mm); CrV 50BV30; 1/2" (12.7 mm) x 5/16" (7.9 mm); CrV 50BV30; 5/16" (7.9 mm): 8, 10, 12 mm (L=30 mm); AISI S2; 5/16" (7.9 mm): PH3, PH4 (L=30 mm); AISI S2; 5/16" (7.9 mm): PZ3, PZ4 (L=30 mm); AISI S2; 5/16" (7.9 mm): T40, T45, T50, T55, T60 (L=30 mm); AISI S2; 5/16" (7.9 mm): 7, 8, 10, 12, 14 mm (L=30 mm); AISI S2; 1/4" (6.3 mm): 4, 5.5, 6.5 mm (L=37 mm); AISI S2 / CrV 6150; 1/4" (6.3 mm): PH1, PH2 (L=37 mm); AISI S2 / CrV 6150; 1/4" (6.3 mm): PZ1, PZ2 (L=37 mm); AISI S2 / CrV 6150; 1/4" (6.3 mm): T8, T10, T15, T20, T25, T27, T30 (L=37 mm); AISI S2 / CrV 6150; 1/4" (6.3 mm): 3, 4, 5, 6 mm (L=37 mm); AISI S2 / CrV 6150; 1.5, 2, 2.5 mm; CrV 6150

YATO	1/2" (12.7 mm)	1/4" (6.3 mm)	2
YT-38791			



BMC & COLOR SLEEVE
XXL SIZE



109
PCS

CrV
6140

1/2" (12.7 mm): 12, 13, 14, 15, 16, 17, 18, 19, 20, 21, 22, 24 mm (L=38 mm); 27, 30, 32 mm (L=42 mm), 1/4" (6.3 mm): 4, 4.5, 5, 5.5, 6, 7, 8, 9, 10, 11, 12, 13, 14 mm (L=25 mm); CrV 50BV30; 1/2" (12.7 mm): 10, 12, 13, 14, 17, 19 mm (L=76 mm), 1/4" (6.3 mm): 4, 5, 6, 7, 8, 9 mm (L=50 mm); CrV 50BV30; 1/2" (12.7 mm): E10, E12, E14, E16, E18, E20, E22, E24; CrV 6150; 1/2" (12.7 mm); (254 mm), 1/4" (6.3 mm); (152.4 mm); CrV 50BV30; 3/8" (9.5 mm) (F) x 1/2" (12.7 mm) (M), 3/8" (9.5 mm) (F) x 1/4" (6.3 mm) (M); CrV 50BV30; 1/2" (12.7 mm), 1/4" (6.3 mm); CrV 50BV30; 1/2" (12.7 mm): 16, 21 mm; CrV 50BV30; 1/2" (12.7 mm); (255 mm), 1/4" (6.3 mm); (155 mm); 72T; CrMo 440; 1/4" (6.3 mm); (150 mm); CrV 50BV30; 1/4" (6.3 mm): 1/4" (6.3 mm): 4, 5.5, 6.5 mm (L=37 mm); AISI S2 / CrV 6150; 1/4" (6.3 mm): PH1, PH2, PH3 (L=37 mm); AISI S2 / CrV 6150; 1/4" (6.3 mm): PZ2, PZ3 (L=37 mm); AISI S2 / CrV 6150; 1/4" (6.3 mm): T8, T10, T15, T20, T25 (L=37 mm); AISI S2 / CrV 6150; 1/4" (6.3 mm): T10, T15, T20, T25, T40 (L=37 mm); AISI S2 / CrV 6150; 1/4" (6.3 mm): 3, 4, 5, 6 mm (L=37 mm); AISI S2 / CrV 6150; 8, 9, 10, 11, 12, 13, 14, 15, 16, 17, 18, 19 mm; CrV; 8x9, 10x11, 12x13, 14x15 mm; CrV 50BV30; 8x10, 12x13, 17x19 mm; CrV 6140; 3x75, 4x100, 6x150, PH1x75, PH2x100, PH3x150 mm; S2; 180 mm; 160 mm; 300 g

YATO	1/2" (12.7 mm)	1/4" (6.3 mm)	2
YT-38891			

GB Tool set
D Sechskant-Steckschlüssel-Satz
PL Zestaw narzędziowy
RUS Набор инструмента

CZ Sada nástrčných kľúčů a ráčny
H Dugókulcs készlet racsnis hajtókarral
RO Trusa de scule
F Coffret d'outillage

I Set di utensili
E Juego de herramientas
CN 套筒扳手组套

BMC & COLOR SLEEVE
XXL SIZE



122 PCS	1/2" 12.5mm	1/4" 6.3mm
CrV 50BV30	CrV 6150	
CrMo 440	S2	
72T	AS-DRIVE	



1/2" (12.7 mm): 12, 13, 14, 15, 16, 17, 18, 19, 20, 21, 22, 24 mm (L=38 mm); 27, 30, 32 mm (L=42 mm), 1/4" (6.3 mm): 4, 4.5, 5, 5.5, 6, 7, 8, 9, 10, 11, 12, 13, 14 mm (L=25 mm); CrV 50BV30; 1/2" (12.7 mm): 10, 12, 13, 14, 17, 19 mm (L=76 mm), 1/4" (6.3 mm): 4, 5, 6, 7, 8, 9 mm (L=50 mm); CrV 50BV30; 1/2" (12.7 mm): E10, E12, E14, E16, E18, E20, E22, E24; CrV 6150; 1/2" (12.7 mm): (254 mm), 1/4" (6.3 mm): (152.4 mm); CrV 50BV30; 3/8" (9.5 mm) (F) x 1/2" (12.7 mm) (M), 3/8" (9.5 mm) (F) x 1/4" (6.3 mm) (M); CrV 50BV30; 1/2" (12.7 mm), 1/4" (6.3 mm); CrV 50BV30; 1/2" (12.7 mm): 16, 21 mm; CrV 50BV30; 1/2" (12.7 mm): (255 mm), 1/4" (6.3 mm): (155 mm); 72T; CrMo 440; 1/4" (6.3 mm): (150 mm); CrV 50BV30; 1/4" (6.3 mm) x 1/4" (6.3 mm); CrV 50BV30; 1/4" (6.3 mm): 3, 4, 5, 6 mm (L=25 mm); AISI S2; 1/4" (6.3 mm): PH0, PH1, PH2 (L=25 mm); AISI S2; 1/4" (6.3 mm): PZ0, PZ1, PZ2 (L=25 mm); AISI S2; 1/4" (6.3 mm): 4, 5.5, 6.5 mm (L=37 mm); AISI S2 / CrV 6150; 1/4" (6.3 mm): PH1, PH2, PH3 (L=37 mm); AISI S2 / CrV 6150; 1/4" (6.3 mm): PZ2, PZ3 (L=37 mm); AISI S2 / CrV 6150; 1/4" (6.3 mm): T8, T10, T15, T20, T25 (L=37 mm); AISI S2 / CrV 6150; 1/4" (6.3 mm): T10, T15, T20, T25, T40 (L=37 mm); AISI S2 / CrV 6150; 1/4" (6.3 mm): 3, 4, 5, 6 mm (L=37 mm); AISI S2 / CrV 6150; 8, 9, 10, 11, 12, 13, 14, 15, 16, 17, 18, 19 mm; CrV; 4x100, 6x150, PH2x100, PH3x150 mm; S2; 180 mm; 160 mm; 160 mm; 250 mm; CrV; 300 g; 2, 2.5, 3, 4, 5, 6, 7, 8, 10 mm; CrV 6150

YATO			
YT-38901	1/2" (12.7 mm)	1/4" (6.3 mm)	2

GB Tool set
D Sechskant-Steckschlüssel-Satz
PL Zestaw narzędziowy
RUS Набор инструмента

CZ Sada nástrčných kľúčů a ráčny
H Dugókulcs készlet racsnis hajtókarral
RO Trusa de scule
F Coffret d'outillage

I Set di utensili
E Juego de herramientas
CN 套筒扳手组套

BMC & COLOR SLEEVE
XL SIZE



111 PCS	1/2" 12.5mm	3/8" 10mm	1/4" 6.3mm
CrV 50BV30	CrV 6150	CrMo 440	
S2	72T	AS-DRIVE	



1/2" (12.7 mm): 14, 15, 16, 17, 18, 19, 20, 21, 22, 23, 24 mm (L=38 mm); 27, 30, 32 mm (L=42 mm), 3/8" (9.5 mm): 9, 10, 11, 12, 13, 14, 15, 16 mm (L=28 mm); 17, 18, 19 mm (L=30 mm), 1/4" (6.3 mm): 3.5, 4, 4.5, 5, 5.5, 6, 7, 8, 9, 10, 11, 12, 13 mm (L=25 mm); CrV 50BV30; 1/2" (12.7 mm): (127, 254 mm), 3/8" (9.5 mm): (76, 152.4 mm), 1/4" (6.3 mm): (50.8, 152.4 mm); CrV 50BV30; 3/8" (9.5 mm) (F) x 1/2" (12.7 mm) (M), 1/2" (12.7 mm) (F) x 3/8" (9.5 mm) (M), 3/8" (9.5 mm) (F) x 1/4" (6.3 mm) (M); CrV 50BV30; 1/2" (12.7 mm), 3/8" (9.5 mm), 1/4" (6.3 mm); CrV 50BV30; 1/2" (12.7 mm): 16, 21 mm, 3/8" (9.5 mm): 16, 21 mm; CrV 50BV30; 1/2" (12.7 mm): (255 mm), 3/8" (9.5 mm): (200 mm), 1/4" (6.3 mm): (155 mm); 72T; CrMo 440; 1/4" (6.3 mm): (150 mm); CrV 50BV30; 1/2" (12.7 mm) x 5/16" (7.9 mm), 3/8" (9.5 mm) x 5/16" (7.9 mm); CrV 50BV30; 5/16" (7.9 mm): 6, 6.5, 8 mm (L=30 mm); AISI S2; 5/16" (7.9 mm): PH2, PH3 (L=30 mm); AISI S2; 5/16" (7.9 mm): PZ2, PZ3 (L=30 mm); AISI S2; 5/16" (7.9 mm): T27, T30, T35, T40, T45 (L=30 mm); AISI S2; 5/16" (7.9 mm): 5.5, 6, 6.5 mm (L=30 mm); AISI S2; 1/4" (6.3 mm): 4, 5.5, 6.5 mm (L=37 mm); AISI S2 / CrV 6150; 1/4" (6.3 mm): PH1, PH2 (L=37 mm); AISI S2 / CrV 6150; 1/4" (6.3 mm): PZ1, PZ2 (L=37 mm); AISI S2 / CrV 6150; 1/4" (6.3 mm): T8, T10, T15, T20, T25 (L=37 mm); AISI S2 / CrV 6150; 1/4" (6.3 mm): T10, T15, T20, T25, T40 (L=37 mm); AISI S2 / CrV 6150; 1/4" (6.3 mm): 3, 4, 5, 6 mm (L=37 mm); AISI S2 / CrV 6150; 8, 9, 10, 11, 12, 13, 14, 15, 16, 17, 18, 19 mm; CrV; 1.5, 2, 2.5 mm; CrV 6150

YATO			
YT-38831	1/2" (12.7 mm)	3/8" (9.5 mm)	1/4" (6.3 mm)

GB Tool set
D Sechskant-Steckschlüssel-Satz
PL Zestaw narzędziowy
RUS Набор инструмента

CZ Sada nástrčných klíčů a ráčny
H Dugókulcs készlet racsni hajtókarral
RO Trusa de scule
F Coffret d'outillage

I Set di utensili
E Juego de herramientas
CN 套筒扳手组套

BMC & COLOR SLEEVE
XL SIZE



1/2"	3/8"	1/4"
12.5mm	10mm	6.3mm
CrV 50BV30	CrV 6150	S2
72T	AS-DRIVE	

2

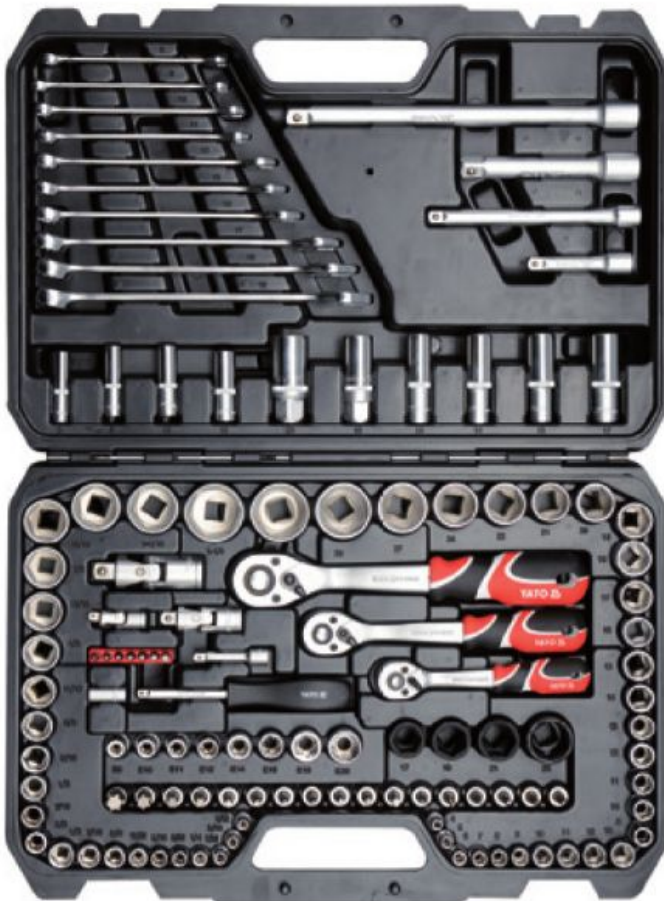

120
PCS

METRIC
& S.A.E.

CrMo
440

1/2" (12.7 mm): 20, 21, 22, 24 mm (L=38 mm); 27, 30, 32 mm (L=42 mm), 3/8" (9.5 mm): 9, 10, 11, 12, 13, 14, 15, 16 mm (L=28 mm); 17, 18, 19 mm (L=30 mm), 1/4" (6.3 mm): 4, 5, 6, 7, 8, 9, 10, 11, 12, 13 mm (L=25 mm); CrV 50BV30; 3/8" (9.5 mm): 13, 14, 15, 17 mm (L=63 mm), 1/4" (6.3 mm): 8, 9, 10, 12 mm (L=50 mm); CrV 50BV30; 1/2" (12.7 mm) x 15/16" (23.8 mm), 1/2" (12.7 mm) x 1" (25.4 mm), 1/2" (12.7 mm) x 1-1/16" (27.0 mm), 1/2" (12.7 mm) x 1-1/4" (31.8 mm), 3/8" (9.5 mm) x 3/8" (9.5 mm), 3/8" (9.5 mm) x 7/16" (11.1 mm), 3/8" (9.5 mm) x 1/2" (12.7 mm), 3/8" (9.5 mm) x 9/16" (14.3 mm), 3/8" (9.5 mm) x 5/8" (15.9 mm), 3/8" (9.5 mm) x 11/16" (17.5 mm), 3/8" (9.5 mm) x 3/4" (19.0 mm), 3/8" (9.5 mm) x 13/16" (20.6 mm), 3/8" (9.5 mm) x 7/8" (22.2 mm), 1/4" (6.3 mm) x 5/32" (4.0 mm), 1/4" (6.3 mm) x 3/16" (4.8 mm), 1/4" (6.3 mm) x 7/32" (5.6 mm), 1/4" (6.3 mm) x 1/4" (6.3 mm), 1/4" (6.3 mm) x 9/32" (7.1 mm), 1/4" (6.3 mm) x 5/16" (7.9 mm), 1/4" (6.3 mm) x 11/32" (8.7 mm), 1/4" (6.3 mm) x 3/8" (9.5 mm), 1/4" (6.3 mm) x 7/16" (11.1 mm), 1/4" (6.3 mm) x 1/2" (12.7 mm); CrV 50BV30; 1/2" (12.7 mm): 17, 19, 21, 23 mm; CrV 50BV30; 3/8" (9.5 mm): E8, E10, E11, E12, E14, E16, E18, E20; CrV 6150; 1/2" (12.7 mm): (127, 254 mm), 3/8" (9.5 mm): (76, 152.4 mm), 1/4" (6.3 mm): (50.8 mm); CrV 50BV30; 1/2" (12.7 mm): 3/8" (9.5 mm), 1/4" (6.3 mm); CrV 50BV30; 3/8" (9.5 mm): 16, 21 mm; CrV 50BV30; 1/2" (12.7 mm): (255 mm), 3/8" (9.5 mm): (200 mm), 1/4" (6.3 mm): (155 mm); 72T; CrMo 440; 1/4" (6.3 mm): (150 mm); CrV 50BV30; 1/4" (6.3 mm) x 1/4" (6.3 mm); CrV 50BV30; 1/4" (6.3 mm): T10, T15, T20, T25, T27, T30, T40 (L=25 mm); AISI S2; 3/8" (9.5 mm): 5.5, 6.5 mm (L=50 mm); AISI S2 / CrV 6150; 3/8" (9.5 mm): PH1, PH2 (L=50 mm); AISI S2 / CrV 6150; 3/8" (9.5 mm): PZ1, PZ2 (L=50 mm); AISI S2 / CrV 6150; 3/8" (9.5 mm): T20, T30, T40, T45, T50, T55, T60 (L=50 mm); AISI S2 / CrV 6150; 3/8" (9.5 mm): 3, 4, 5, 6 mm (L=50 mm); AISI S2 / CrV 6150; 8, 9, 10, 11, 12, 13, 14, 17, 18, 19 mm; CrV

YATO				
YT-38801	1/2" (12.7 mm)	3/8" (9.5 mm)	1/4" (6.3 mm)	2



126
PCS

CrV
6140

1/2" (12.7 mm): 20, 21, 22, 24 mm (L=38 mm); 27, 30, 32 mm (L=42 mm), 3/8" (9.5 mm): 9, 10, 11, 12, 13, 14, 15, 16 mm (L=28 mm); 17, 18, 19 mm (L=30 mm), 1/4" (6.3 mm): 4, 4.5, 5, 5.5, 6, 7, 8, 9, 10, 11, 12, 13 mm (L=25 mm); CrV 50BV30; 3/8" (9.5 mm): 13, 14, 15, 17 mm (L=63 mm), 1/4" (6.3 mm): 8, 9, 10, 12 (L=50 mm); CrV 50BV30; 3/8" (9.5 mm): E8, E10, E11, E12, E14, E16, E18, E20; CrV 6150; 1/2" (12.7 mm): (127, 254 mm), 3/8" (9.5 mm): (76, 152.4 mm), 1/4" (6.3 mm): (50.8 mm); CrV 50BV30; 3/8" (9.5 mm) (F) x 1/2" (12.7 mm) (M); CrV 50BV30; 1/2" (12.7 mm), 3/8" (9.5 mm), 1/4" (6.3 mm); CrV 50BV30; 3/8" (9.5 mm): 16, 21 mm; CrV 50BV30; 1/2" (12.7 mm): (255 mm), 3/8" (9.5 mm): (200 mm), 1/4" (6.3 mm): (155 mm); 72T; CrV 6140; 1/4" (6.3 mm): (150 mm); CrV 50BV30; 1/2" (12.7 mm) (F) x 3/8" (9.5 mm) (M), 3/8" (9.5 mm) (F) x 1/2" (12.7 mm) (M), 3/8" (9.5 mm) (F) x 1/4" (6.3 mm) (M); CrV 50BV30; 1/4" (6.3 mm) x 1/4" (6.3 mm); CrV 6140; 1/4" (6.3 mm): 4, 5, 6.5 mm (L=25 mm); AISI S2; 1/4" (6.3 mm): PH1, PH3 (L=25 mm); AISI S2; 1/4" (6.3 mm): PZ1, PZ2 (L=25 mm); AISI S2; 1/4" (6.3 mm): T10, T15, T20, T25, T27, T30, T40 (L=25 mm); AISI S2; 1/4" (6.3 mm): 3, 4, 5, 6 mm (L=25 mm); AISI S2; 3/8" (9.5 mm): 5.5, 6.5 mm (L=50 mm); AISI S2 / CrV 6150; 3/8" (9.5 mm): PH1, 2xPH2 (L=50 mm); AISI S2 / CrV 6150; 3/8" (9.5 mm): T20, T30, T40 (L=50 mm); AISI S2 / CrV 6150; 3/8" (9.5 mm): T45, T50, T55, T60 (L=50 mm); AISI S2 / CrV 6150; 3/8" (9.5 mm): 3, 4, 5, 6, 7 mm (L=50 mm); AISI S2 / CrV 6150; 1/2" (12.7 mm): M10 (L=100 mm); AISI S2 / CrV 6150; 8, 10, 12, 13, 14, 16, 17, 18, 19 mm; CrV; 8x10 mm, 11x12 mm; CrV 6140; 6x100 mm, PH2x100 mm; CrV 6150; 6-24 V; 150 mm; 1/2" (12.7 mm), 3/8" (9.5 mm); 63-120 mm; CrV; 1.5, 2, 2.5, 3, 4, 5, 6, 8, 10 mm; S2

YATO				
YT-38875	1/2" (12.7 mm)	3/8" (9.5 mm)	1/4" (6.3 mm)	2

GB Tool set
 D Sechskant-Steckschlüssel-Satz
 PL Zestaw narzędziowy
 RUS Набор инструмента

CZ Sada nástrčných klíčů a ráčny
 H Dugókulcs készlet racsnis hajtókarral
 RO Trusa de scule
 F Coffret d'outillage

I Set di utensili
 E Juego de herramientas
 CV 套筒扳手组套

1/2" 12.5mm	3/8" 10mm	1/4" 6.3mm
CrV 50BV30	CrV 6150	CrMo 440
S2	72T	AS-DRIVE

2



128
PCS

BMC & COLOR
SLEEVE
XL SIZE



1/2" (12.7 mm): 14, 15, 16, 17, 18, 19, 20, 21, 22, 24 mm (L=38 mm); 27, 30, 32 mm (L=42 mm), 3/8" (9.5 mm): 10, 11, 12, 13, 14, 15, 16 mm (L=28 mm); 17, 18 mm (L=30 mm), 1/4" (6.3 mm): 6, 7, 8, 9, 10, 11, 12, 13 mm (L=25 mm); CrV 50BV30; 1/2" (12.7 mm): 17, 18, 19, 22 mm (L=76 mm), 3/8" (9.5 mm): 8, 10, 12, 13, 14, 15 mm (L=63 mm), 1/4" (6.3 mm): 6, 7, 8, 10, 12, 13 mm (L=50 mm); CrV 50BV30; 1/2" (12.7 mm): 17, 19, 21, 22 mm; CrV 50BV30; 3/8" (9.5 mm): E8, E10, E11, E12, E14, E16; CrV 6150; 1/2" (12.7 mm); (127, 254 mm), 3/8" (9.5 mm); (152.4, 254 mm), 1/4" (6.3 mm); (50.8, 101.6 mm); CrV 50BV30; 3/8" (9.5 mm) (F) x 1/2" (12.7 mm) (M); CrV 50BV30; 1/2" (12.7 mm), 3/8" (9.5 mm), 1/4" (6.3 mm); CrV 50BV30; 1/2" (12.7 mm): 16, 21 mm; CrV 50BV30; 3/8" (9.5 mm); (198 mm), 1/4" (6.3 mm); (152.4 mm); CrV 50BV30; 1/2" (12.7 mm); (255 mm), 3/8" (9.5 mm); (200 mm), 1/4" (6.3 mm); (155 mm); 72T; CrMo 440; 1/4" (6.3 mm); (150 mm); CrV 50BV30; 1/2" (12.7 mm); (250 mm); CrV 50BV30; 3/8" (9.5 mm) x 5/16" (7.9 mm); CrV 50BV30; 1/2" (12.7 mm) x 3/8" (9.5 mm), 3/8" (9.5 mm) x 1/4" (6.3 mm); CrV 50BV30; 1/4" (6.3 mm) x 1/4" (6.3 mm); CrV 50BV30; 3/8" (9.5 mm): 5.5, 6.5 mm (L=70 mm); AISI S2; 3/8" (9.5 mm): PH1, PH2, PH3 (L=70 mm); AISI S2; 3/8" (9.5 mm): T20, T30, T40, T45, T50, T55 (L=70 mm); AISI S2; 3/8" (9.5 mm): 6, 7, 8, 10, 12 mm (L=70 mm); AISI S2; 1/4" (6.3 mm): PZ1, PZ2 (L=25 mm); AISI S2; 1/4" (6.3 mm): T8, T10 (L=25 mm); AISI S2; 1/4" (6.3 mm): 4.0, 5.5, 6.5 mm (L=37 mm); AISI S2 / CrV 6150; 1/4" (6.3 mm): PH1, PH2 (L=37 mm); AISI S2 / CrV 6150; 1/4" (6.3 mm): T8, T10, T15, T20, T25, T30, T40 (L=37 mm); AISI S2 / CrV 6150; 1/4" (6.3 mm): 3, 4, 5, 6 mm (L=37 mm); AISI S2 / CrV 6150; 8, 10, 12, 13, 14, 15, 16, 17, 18, 19 mm; CrV; 1.5, 2, 2.5 mm; CrV 6150

YATO	1/2" (12.7 mm)	3/8" (9.5 mm)	1/4" (6.3 mm)	2
YT-38872	1/2" (12.7 mm)	3/8" (9.5 mm)	1/4" (6.3 mm)	2



129
PCS

BMC & COLOR
SLEEVE
XXL SIZE



1/2" (12.7 mm): 12, 13, 14, 15, 16, 17, 18, 19, 20, 21, 22, 24 mm (L=38 mm); 27, 30, 32 mm (L=42 mm), 3/8" (9.5 mm): 10, 11, 12, 13, 14, 15, 16 mm (L=28 mm); 17, 18, 19 mm (L=30 mm), 1/4" (6.3 mm): 4, 4.5, 5, 5.5, 6, 7, 8, 9, 10, 11, 12, 13, 14 mm (L=25 mm); CrV 50BV30; 1/2" (12.7 mm): 10, 12, 13, 14, 17, 19 mm (L=76 mm), 1/4" (6.3 mm): 4, 5, 6, 7, 8, 9 mm (L=50 mm); CrV 50BV30; 1/2" (12.7 mm): 17, 19, 21, 23 mm; CrV 50BV30; 3/8" (9.5 mm): E8, E10, E11, E12, E14, E16, E18, E20; CrV 6150; 1/2" (12.7 mm); (127, 254 mm), 3/8" (9.5 mm); (76, 152.4 mm), 1/4" (6.3 mm); (50.8 mm); CrV 50BV30; 1/2" (12.7 mm), 3/8" (9.5 mm), 1/4" (6.3 mm); CrV 50BV30; 3/8" (9.5 mm): 16, 21 mm; CrV 50BV30; 1/2" (12.7 mm); (255 mm), 3/8" (9.5 mm); (200 mm), 1/4" (6.3 mm); (155 mm); 72T; CrMo 440; 1/4" (6.3 mm); (150 mm); CrV 50BV30; 1/4" (6.3 mm); 5.5, 6.5 mm (L=50 mm); AISI S2 / CrV 6150; 3/8" (9.5 mm): PH1, PH2, PH3 (L=50 mm); AISI S2 / CrV 6150; 3/8" (9.5 mm): PZ1, PZ2, PZ3 (L=50 mm); AISI S2 / CrV 6150; 3/8" (9.5 mm): T20, T30, T40, T45, T50, T55, T60 (L=50 mm); AISI S2 / CrV 6150; 3/8" (9.5 mm): 3, 4, 5, 6, 8, 10 mm (L=50 mm); AISI S2 / CrV 6150; 8, 10, 11, 12, 13, 14, 15, 16, 17, 18, 19, 22 mm; CrV; 3x75, 4x100, 6x150, PH1x75, PH2x100, PH3x150 mm; S2; 160 mm; 160 mm; 160 mm; 1.5, 2, 2.5, 3, 4, 5, 6, 7, 8, 10 mm; CrV 6150

YATO	1/2" (12.7 mm)	3/8" (9.5 mm)	1/4" (6.3 mm)	2
YT-38881	1/2" (12.7 mm)	3/8" (9.5 mm)	1/4" (6.3 mm)	2

GB Tool set
D Sechskant-Steckschlüssel-Satz
PL Zestaw narzędziowy
RUS Набор инструмента

CZ Sada nástrčných klíčů a ráčny
H Dugókulcs készlet racsnis hajtókarral
RO Trusa de scule
F Coffret d'outillage

I Set di utensili
E Juego de herramientas
CN 套筒扳手组套

1/2" 12.5mm	3/8" 10mm	1/4" 6.3mm	CrV 50BV30	CrV 6150
CrMo 440	S2	72T	AS-DRIVE	

2



150 PCS METRIC & S.A.E. CrV 6140

BMC & COLOR SLEEVE XXL SIZE



1/2" (12.7 mm): 20, 21, 22, 24 mm (L=38 mm); 27, 30, 32 mm (L=42 mm), 3/8" (9.5 mm): 9, 10, 11, 12, 13, 14, 15, 16 mm (L=28 mm); 17, 18, 19 mm (L=30 mm), 1/4" (6.3 mm): 4, 5, 6, 7, 8, 9, 10, 11, 12, 13 mm (L=25 mm); CrV 50BV30; 1/2" (12.7 mm): 10, 12, 13, 14, 17, 19 mm (L=76 mm), 3/8" (9.5 mm): 10, 11, 12, 13, 14, 15 mm (L=63 mm), 1/4" (6.3 mm): 4, 5, 6, 7, 8, 9 mm (L=50 mm); CrV 50BV30; 1/2" (12.7 mm) x 15/16" (23.8 mm), 1/2" (12.7 mm) x 1" (25.4 mm), 1/2" (12.7 mm) x 1-1/16" (27.0 mm), 1/2" (12.7 mm) x 1-1/4" (31.8 mm), 3/8" (9.5 mm) x 3/8" (9.5 mm), 3/8" (9.5 mm) x 7/16" (11.1 mm), 3/8" (9.5 mm) x 1/2" (12.7 mm), 3/8" (9.5 mm) x 9/16" (14.3 mm), 3/8" (9.5 mm) x 5/8" (15.9 mm), 3/8" (9.5 mm) x 11/16" (17.5 mm), 3/8" (9.5 mm) x 3/4" (19.0 mm), 3/8" (9.5 mm) x 13/16" (20.6 mm), 3/8" (9.5 mm) x 7/8" (22.2 mm), 1/4" (6.3 mm) x 5/32" (4.0 mm), 1/4" (6.3 mm) x 3/16" (4.8 mm), 1/4" (6.3 mm) x 7/32" (5.6 mm), 1/4" (6.3 mm) x 1/4" (6.3 mm), 1/4" (6.3 mm) x 9/32" (7.1 mm), 1/4" (6.3 mm) x 5/16" (7.9 mm), 1/4" (6.3 mm) x 11/32" (8.7 mm), 1/4" (6.3 mm) x 3/8" (9.5 mm), 1/4" (6.3 mm) x 7/16" (11.1 mm), 1/4" (6.3 mm) x 1/2" (12.7 mm); CrV 50BV30; 1/2" (12.7 mm): 17, 19, 21, 23 mm; CrV 50BV30; 3/8" (9.5 mm): E8, E10, E11, E12, E14, E16, E18, E20; CrV 6150; 1/2" (12.7 mm): (127, 254 mm), 3/8" (9.5 mm): (76, 152.4 mm), 1/4" (6.3 mm): (50.8 mm); CrV 50BV30; 1/2" (12.7 mm), 3/8" (9.5 mm): 16, 21 mm; CrV 50BV30; 1/2" (12.7 mm): 16, 21 mm; CrV 50BV30; 1/2" (12.7 mm): (255 mm), 3/8" (9.5 mm): (200 mm), 1/4" (6.3 mm): (155 mm); 72T; CrMo 440; 1/4" (6.3 mm): (150 mm); CrV 50BV30; 1/4" (6.3 mm) x 1/4" (6.3 mm): CrV 50BV30; 1/4" (6.3 mm): T10, T15, T20, T25, T27, T30, T40 (L=25 mm); AISI S2; 3/8" (9.5 mm): 4, 5, 5, 6, 5 mm (L=50 mm); AISI S2 / CrV 6150; 3/8" (9.5 mm): PH1, PH2, PH3 (L=50 mm); AISI S2 / CrV 6150; 3/8" (9.5 mm): PZ1, PZ2, PZ3 (L=50 mm); AISI S2 / CrV 6150; 3/8" (9.5 mm): T20, T30, T40, T45, T50, T55, T60 (L=50 mm); AISI S2 / CrV 6150; 3/8" (9.5 mm): 3, 4, 5, 6, 8, 10 mm (L=50 mm); AISI S2 / CrV 6150; 8, 9, 10, 11, 12, 13, 14, 15, 16, 17, 18, 19 mm; CrV; 8x10, 12x13, 17x19 mm; CrV 6140; 1.5, 2, 2.5, 3, 4, 5, 6, 7, 8, 10 mm; CrV 6150

YATO				
YT-38811	1/2" (12.7 mm)	3/8" (9.5 mm)	1/4" (6.3 mm)	2



173 PCS CrV 40

BMC & COLOR SLEEVE XL SIZE



1/2" (12.7 mm): 10, 11, 12, 13, 14, 15, 16, 17, 18, 19, 20, 21, 22, 23, 24 mm (L=38 mm); 27, 30, 32 mm (L=42 mm), 3/8" (9.5 mm): 10, 11, 12, 13, 14, 15, 16 mm (L=28 mm); 17, 18, 19 mm (L=30 mm), 1/4" (6.3 mm): 4, 4.5, 5, 5.5, 6, 7, 8, 9, 10, 11, 12, 13, 14 mm (L=25 mm); CrV 50BV30; 1/2" (12.7 mm): 16, 17, 18, 19, 22 mm (L=76 mm), 3/8" (9.5 mm): 10, 11, 12, 13, 14, 15 mm (L=63 mm), 1/4" (6.3 mm): 4, 5, 6, 7, 8, 9, 10 mm (L=50 mm); CrV 50BV30; 1/2" (12.7 mm): E18, E20, E24, 3/8" (9.5 mm): E10, E11, E12, E14, E16, 1/4" (6.3 mm): E4, E5, E6, E7, E8; CrV 6150; 1/2" (12.7 mm): (127, 254 mm), 3/8" (9.5 mm): (152.4 mm), 1/4" (6.3 mm): (50.8, 101.6 mm); CrV 50BV30; 3/8" (9.5 mm) (F) x 1/2" (12.7 mm); CrV 50BV30; 1/2" (12.7 mm), 3/8" (9.5 mm), 1/4" (6.3 mm); CrV 50BV30; 1/2" (12.7 mm): 16, 21 mm, 3/8" (9.5 mm): 18 mm; CrV 50BV30; 1/4" (6.3 mm); CrV 40; 1/2" (12.7 mm); (255 mm), 3/8" (9.5 mm); (200 mm), 1/4" (6.3 mm); (155 mm); 72T; CrMo 440; 1/4" (6.3 mm); (150 mm); CrV 50BV30; 1/2" (12.7 mm) x 5/16" (7.9 mm), 3/8" (9.5 mm) x 5/16" (7.9 mm); CrV 50BV30; 1/4" (6.3 mm) x 1/4" (6.3 mm); CrV 50BV30; 5/16" (7.9 mm): 8, 10, 12 mm (L=30 mm); AISI S2; 5/16" (7.9 mm): PH3, PH4 (L=30 mm); AISI S2; 5/16" (7.9 mm): PZ3, PZ4 (L=30 mm); AISI S2; 5/16" (7.9 mm): T40, T45, T50, T55, T60, T70 (L=30 mm); AISI S2; 5/16" (7.9 mm): T40, T45, T50, T55, T60, T70 (L=30 mm); AISI S2; 5/16" (7.9 mm): 7, 8, 10, 12, 14 mm (L=30 mm); AISI S2; 1/4" (6.3 mm): T5, T6, T7 (L=25 mm); AISI S2; 1/4" (6.3 mm): T7, T10, T15, T20, T25, T27, T30, T40, T45 (L=25 mm); AISI S2; 1/4" (6.3 mm): M5, M6, M8 (L=25 mm); AISI S2; 1/4" (6.3 mm): RM5, RM6, RM7, RM8, RM9 (L=25 mm); AISI S2; 1/4" (6.3 mm): 4, 5, 5, 6, 5, 7 mm (L=37 mm); AISI S2 / CrV 6150; 1/4" (6.3 mm): PH0, PH1, PH2 (L=37 mm); AISI S2 / CrV 6150; 1/4" (6.3 mm): PZ0, PZ1, PZ2 (L=37 mm); AISI S2 / CrV 6150; 1/4" (6.3 mm): T8, T9, T10, T15, T20, T25, T27, T30 (L=37 mm); AISI S2 / CrV 6150; 1/4" (6.3 mm): T8, T9, T10, T15, T20, T25, T27, T30 (L=37 mm); AISI S2 / CrV 6150; 1/4" (6.3 mm): 3, 4, 5, 6 mm (L=37 mm); AISI S2 / CrV 6150; 1.25, 1.5, 2, 2.5, 3, 4, 5 mm; CrV 6150

YATO				
YT-38931	1/2" (12.7 mm)	3/8" (9.5 mm)	1/4" (6.3 mm)	2

GB Tool set
D Sechskant-Steckschlüssel-Satz
PL Zestaw narzędziowy
RUS Набор инструмента

CZ Sada nástrčných klíčů a ráčny
H Dugókulcs készlet racsnis hajtókarral
RO Trusa de scule
F Coffret d'outillage

I Set di utensili
E Juego de herramientas
CV 套筒扳手套装

1/2" 12.5mm	3/8" 10mm	1/4" 6.3mm	CrV 50BV30	CrV 6150	CrV 40
CrMo 440	S2	72T	AS-DRIVE	MAGNETIC	

2

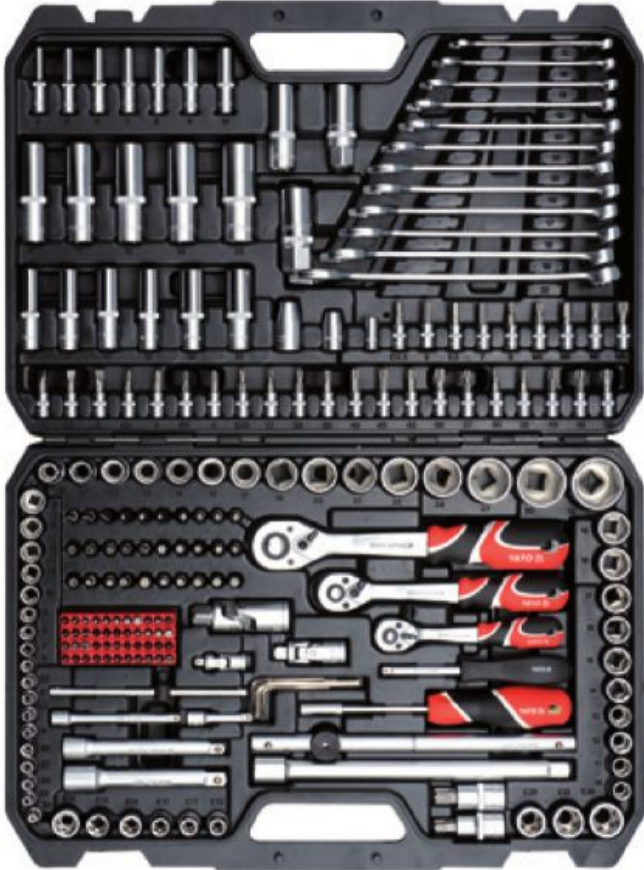

216
PCS

BMC & COLOR
SLEEVE
XXL SIZE



1/2" (12.7 mm): 10, 11, 12, 13, 14, 15, 17, 19, 20, 21, 22, 24 mm (L=38 mm); 27, 30, 32 mm (L=42 mm); 3/8" (9.5 mm): 10, 11, 12, 13, 14, 15, 16 mm (L=28 mm); 17, 18, 19 mm (L=30 mm); 1/4" (6.3 mm): 4, 4.5, 5, 5.5, 6, 7, 8, 9, 10, 11, 12, 13, 14 mm (L=25 mm); CrV 50BV30; 1/2" (12.7 mm): 16, 17, 18, 19, 22 mm (L=76 mm); 3/8" (9.5 mm): 10, 11, 12, 13, 14, 15 mm (L=63 mm); 1/4" (6.3 mm): 4, 5, 6, 7, 8, 9, 10 mm (L=50 mm); CrV 50BV30; 1/2" (12.7 mm): E20, E22, E24, 3/8" (9.5 mm): E10, E11, E12, E14, E16, E18, 1/4" (6.3 mm): E4, E5, E6, E7, E8; CrV 6150; 1/2" (12.7 mm): (127, 254 mm), 3/8" (9.5 mm): (125 mm), 1/4" (6.3 mm): (50.8, 101.6 mm); CrV 50BV30; 1/2" (12.7 mm), 3/8" (9.5 mm), 1/4" (6.3 mm); CrV 50BV30; 1/2" (12.7 mm): 16, 21 mm, 3/8" (9.5 mm): 18 mm; CrV 50BV30; 1/2" (12.7 mm); (255 mm), 1/4" (6.3 mm); (152.4 mm); CrV 40; 1/2" (12.7 mm); (255 mm), 3/8" (9.5 mm); (200 mm), 1/4" (6.3 mm); (155 mm); 72T, CrMo 440; 1/4" (6.3 mm); (150 mm); CrV 50BV30; 1/4" (6.3 mm); (200 mm); CrV 6150; 1/2" (12.7 mm) x 5/16" (7.9 mm); 3/8" (9.5 mm) x 5/16" (7.9 mm); CrV 50BV30; 1/4" (6.3 mm) x 1/4" (6.3 mm); CrV 50BV30; 5/16" (7.9 mm): 6, 6.5, 8 mm (L=30 mm); AISI S2; 5/16" (7.9 mm): PH3, PH4 (L=30 mm); AISI S2; 5/16" (7.9 mm): PZ3, PZ4 (L=30 mm); AISI S2; 5/16" (7.9 mm): T25, T27, T30, T35, 2xT40, T45, T50 (L=30 mm); AISI S2; 5/16" (7.9 mm): T27, T30, T35, T40, T45, T50 (L=30 mm); AISI S2; 5/16" (7.9 mm): 5.5, 6, 6.5, 7, 8 mm (L=30 mm); AISI S2; 5/16" (7.9 mm): M5, M6, M8, M10 (L=30 mm); AISI S2; 1/4" (6.3 mm): 4, 5.5, 6.5 mm (L=25 mm); AISI S2; 1/4" (6.3 mm): PH1, PH2 (L=25 mm); AISI S2; 1/4" (6.3 mm): PZ1, PZ2 (L=25 mm); AISI S2; 1/4" (6.3 mm): T8, T10, T15, T20, T25 (L=25 mm); AISI S2; 1/4" (6.3 mm): T8, 2xT10, 2xT15, 2xT20, 2xT25, T40 (L=25 mm); AISI S2; 1/4" (6.3 mm): 3, 4, 5, 6 mm (L=25 mm); AISI S2; 1/4" (6.3 mm): 3, 4, 5, 6 mm (L=25 mm); AISI S2; 1/4" (6.3 mm): M5, M6, M8 (L=25 mm); AISI S2; 1/4" (6.3 mm): S1, S2 (L=25 mm); AISI S2; 1/4" (6.3 mm): 1, 2, 3 mm (L=25 mm); AISI S2; 1/4" (6.3 mm): 6, 8, 10 mm (L=25 mm); AISI S2; 1/4" (6.3 mm): 4, 6, 8 mm (L=25 mm); AISI S2; 1/2" (12.7 mm): T55, T60 (L=50 mm); AISI S2 / CrV 6150; 1/4" (6.3 mm): 6, 6.5, 8 mm (L=37 mm); AISI S2 / CrV 6150; 1/4" (6.3 mm): PH3, PH4 (L=37 mm); AISI S2 / CrV 6150; 1/4" (6.3 mm): PZ3, PZ4 (L=37 mm); AISI S2 / CrV 6150; 1/4" (6.3 mm): T25, T27, T30, T35, 2xT40, T45, T50 (L=37 mm); AISI S2 / CrV 6150; 1/4" (6.3 mm): T27, T30, T35, T40, T45, T50 (L=37 mm); AISI S2 / CrV 6150; 1/4" (6.3 mm): 5.5, 6, 6.5, 7, 8 mm (L=37 mm); AISI S2 / CrV 6150; 1/4" (6.3 mm): M5, M6, M8, M10 (L=37 mm); AISI S2 / CrV 6150; 8, 10, 11, 12, 13, 14, 15, 16, 17, 18, 19, 22 mm; CrV; 1.27, 1.5, 2, 2.5, 3, 4, 5 mm; CrV 6150

YATO				
YT-38841	1/2" (12.7 mm)	3/8" (9.5 mm)	1/4" (6.3 mm)	2



225
PCS

METRIC
& S.A.E.
CrV
6140

BMC & COLOR
SLEEVE
XXXL SIZE



1/2" (12.7 mm): 10, 13, 15, 16, 17, 18, 19, 20, 21, 22, 23, 24 mm (L=38 mm); 27, 30, 32 mm (L=42 mm); 3/8" (9.5 mm): 10, 11, 12, 13, 14, 15, 16 mm (L=28 mm); 17, 18, 19 mm (L=30 mm); 1/4" (6.3 mm): 3.5, 4, 4.5, 5, 5.5, 6, 7, 8, 9, 10, 11, 12, 13, 14 mm (L=25 mm); CrV 50BV30; 1/2" (12.7 mm): 10, 11, 12, 13, 14, 15, 17, 19, 21 mm (L=76 mm); 3/8" (9.5 mm): 6, 7, 8, 9, 10 mm (L=63 mm); CrV 50BV30; 1/2" (12.7 mm) x 7/16" (11.1 mm); 1/2" (12.7 mm) x 1/2" (12.7 mm); 1/2" (12.7 mm) x 9/16" (14.3 mm); 1/2" (12.7 mm) x 5/8" (15.9 mm); 1/2" (12.7 mm) x 11/16" (17.5 mm); 1/2" (12.7 mm) x 3/4" (19.0 mm); 1/2" (12.7 mm) x 13/16" (20.6 mm); 1/2" (12.7 mm) x 7/8" (22.2 mm); 1/4" (6.3 mm) x 1/4" (6.3 mm); 1/4" (6.3 mm) x 9/32" (7.1 mm); 1/4" (6.3 mm) x 5/16" (7.9 mm); 1/4" (6.3 mm) x 11/32" (8.7 mm); 1/4" (6.3 mm) x 3/8" (9.5 mm); CrV 50BV30; 1/2" (12.7 mm): 17, 19, 21 mm; CrV 50BV30; 1/2" (12.7 mm): E16, E18, E20, E22, E24, 3/8" (9.5 mm): E10, E11, E12, E14, 1/4" (6.3 mm): E4, E5, E6, E7, E8; CrV 6150; 1/2" (12.7 mm): (127, 254 mm), 3/8" (9.5 mm): (76, 254 mm), 1/4" (6.3 mm): (50.8, 101.6 mm); CrV 50BV30; 3/8" (9.5 mm) (F) x 1/2" (12.7 mm) (M), 1/2" (12.7 mm) (F) x 3/8" (9.5 mm) (M); CrV 50BV30; 1/2" (12.7 mm), 3/8" (9.5 mm), 1/4" (6.3 mm); CrV 50BV30; 1/2" (12.7 mm): 16, 21 mm (L=64 mm); 3/8" (9.5 mm): 18 mm (L=63 mm); CrV 50BV30; 1/4" (6.3 mm); (152.4 mm); CrV 40; 1/2" (12.7 mm); (255 mm), 3/8" (9.5 mm); (200 mm), 1/4" (6.3 mm); (155 mm); 72T, CrMo 440; 1/4" (6.3 mm); (150 mm); CrV 50BV30; 1/4" (6.3 mm); (200 mm); CrV 6140; 1/2" (12.7 mm) x 5/16" (7.9 mm); 3/8" (9.5 mm) x 5/16" (7.9 mm); 3/8" (9.5 mm) x 1/4" (6.3 mm); CrV 50BV30; 1/4" (6.3 mm) x 1/4" (6.3 mm); (L=50 mm), 1/4" (6.3 mm) x 1/4" (6.3 mm) (L=25 mm); CrV 50BV30; 1/4" (6.3 mm) (L=60 mm); 5/16" (7.9 mm): T20, T25, T27, T30, T40, T45, T50, T55 (L=75 mm); AISI S2; 5/16" (7.9 mm): 8, 10 mm (L=30 mm); AISI S2; 5/16" (7.9 mm): PH3, PH4 (L=30 mm); AISI S2; 5/16" (7.9 mm): PZ3, PZ4 (L=30 mm); AISI S2; 5/16" (7.9 mm): T40, T45, T50, T55, T60, T70 (L=30 mm); AISI S2; 5/16" (7.9 mm): T40, T45, T50, T55, T60, T70 (L=30 mm); AISI S2; 5/16" (7.9 mm): 10, 12, 14 mm (L=30 mm); AISI S2; 1/4" (6.3 mm): 3, 4, 5.5, 6.5, 7, 8, 9 mm (L=25 mm); AISI S2; 1/4" (6.3 mm): PH0, PH1, PH2, PH3 (L=25 mm); AISI S2; 1/4" (6.3 mm): PZ0, PZ1, PZ2, PZ3 (L=25 mm); AISI S2; 1/4" (6.3 mm): T8, T9, T10, T15, T20, T25, T27, T30 (L=25 mm); AISI S2; 1/4" (6.3 mm): T8, T9, T10, T15, T20, T25, T27, T30 (L=25 mm); AISI S2; 1/4" (6.3 mm): 3, 4, 5, 6, 7, 8 mm (L=25 mm); AISI S2; 1/4" (6.3 mm): 4, 5, 6, 7, 8 mm (L=25 mm); AISI S2; 1/4" (6.3 mm): 1, 2, 3, 4 (L=25 mm); AISI S2; 1/4" (6.3 mm): 6, 8, 10 (L=25 mm); 1/4" (6.3 mm): 4, 6, 8, 10 mm (L=25 mm); AISI S2; 8, 9, 10, 11, 12, 13, 14, 15, 17, 19, 22 mm; CrV; 6x38, PH2X38; S2; 180 mm; 250 mm; CrV; 2, 2.5, 3, 4, 5, 6, 7, 8, 10, 12 mm; CrV 6150

YATO				
YT-38941	1/2" (12.7 mm)	3/8" (9.5 mm)	1/4" (6.3 mm)	2

GB Tool set
 D Sechskant-Steckschlüssel-Satz
 PL Zestaw narzędziowy
 RUS Набор инструмента

CZ Sada nástrčných kľúčů a ráčny
 H Dugókulcs készlet racsnis hajtókarral
 RO Trusa de scule
 F Coffret d'outillage
 I Set di utensili
 E Juego de herramientas
 CN 套筒扳手套



23 PCS	1/4" 6.3mm	CrV 50BV30
CrV 6140	72T	AS-DRIVE

- 1/4" (6.3 mm): 4, 5, 6, 7, 8, 9, 10, 12, 13 mm (L=25 mm); CrV 50BV30;
- 1/4" (6.3 mm): 4, 5, 6, 7, 8, 9, 10, 12, 13 mm (L=50 mm); CrV 50BV30;
- 1/4" (6.3 mm); (50.8, 152.4 mm); CrV 50BV30;
- 1/4" (6.3 mm); CrV 50BV30;
- 1/4" (6.3 mm); (127 mm); 72T; CrV 6140;
- 1/4" (6.3 mm); (150 mm); CrV 50BV30

YATO	○	
YT-14421	1/4" (6.3 mm)	10

GB Tool set
 D Sechskant-Steckschlüssel-Satz
 PL Zestaw narzędziowy
 RUS Набор инструмента

CZ Sada nástrčných kľúčů a ráčny
 H Dugókulcs készlet racsnis hajtókarral
 RO Trusa de scule
 F Coffret d'outillage

I Set di utensili
 E Juego de herramientas
 CN 套筒扳手套



25 PCS	1/2" 12.5mm	CrV 50BV30
CrV 6140	72T	AS-DRIVE

- 1/2" (12.7 mm): 10, 11, 12, 13, 14, 15, 16, 17, 18, 19, 20, 21, 22, 23, 24 mm (L=38 mm); 27, 30, 32 mm (L=42 mm); CrV 50BV30;
- 1/2" (12.7 mm); (50, 125 mm); CrV 50BV30;
- 1/2" (12.7 mm): 16, 21 mm; CrV 50BV30;
- 1/2" (12.7 mm); (250 mm); CrV 50BV30;
- 1/2" (12.7 mm); (250 mm); 72T; CrV 6140;
- 1/2" (12.7 mm); (317 mm); CrV 50BV30

YATO	○	
YT-12671	1/2" (12.7 mm)	5

GB Tool set
 D Sechskant-Steckschlüssel-Satz
 PL Zestaw narzędziowy
 RUS Набор инструмента

CZ Sada nástrčných kľúčů a ráčny
 H Dugókulcs készlet racsnis hajtókarral
 RO Trusa de scule
 F Coffret d'outillage

I Set di utensili
 E Juego de herramientas
 CN 套筒扳手套



60 PCS	1/4" 6.3mm	CrV 50BV30
CrV 6150	CrV 6140	S2
SK5	72T	AS-DRIVE



- 1/4" (6.3 mm): 5, 6, 7, 8, 9, 10, 11, 12, 13 mm (L=25 mm); CrV 50BV30;
- 1/4" (6.3 mm); (155 mm), 72T; CrV 6140;
- 1/4" (6.3 mm); (200 mm); CrV;
- 1/4" (6.3 mm); (L=60 mm); S2;
- 1/4" (6.3 mm): 3, 4, 5, 6, 7 mm (L=25 mm); AISI S2;
- 1/4" (6.3 mm): PH0, PH1, 2xPH2, 2xPH3 (L=25 mm); AISI S2;
- 1/4" (6.3 mm): PZ0, PZ1, 2xPZ2, PZ3 (L=25 mm); AISI S2;
- 1/4" (6.3 mm): T10, T15, T20, T25, T27, T30, T40 (L=25 mm); AISI S2;
- 1/4" (6.3 mm): 2, 3, 4, 5, 5.5, 6 mm (L=25 mm); AISI S2;
- 1/4" (6.3 mm): S0, S1, S2 (L=25 mm); AISI S2;
- 160 mm; 160 mm;
- 150 mm; 300 g;
- 3 m x16 mm; 18 mm; SK5;
- 230 mm;
- 1.5, 2, 2.5, 3, 4, 5, 6, 8, 10 mm; CrV 6150

YATO	○	
YT-38920	1/4" (6.3 mm)	4

2

- GB Tool set
- D Sechskant-Steckschlüssel-Satz
- PL Zestaw narzędziowy
- RUS Набор инструмента
- CZ Sada nástrčných kľučí a ráčny
- H Dugókulcs készlet racsnis hajtókarral
- RO Trusa de scule
- F Coffret d'outillage
- I Set di utensili
- E Juego de herramientas
- CN 套筒扳手组套



44 PCS	1/4" 6.3mm	⊖	⊕	⊗	⊙	⊚
		CrV		S2	SK2	



- ⌀6x7, 8x9, 10x11, 12x13, 14x15 mm;
- 1/4" (6.3 mm): 3, 4, 5, 5.5, 6 mm (L=25 mm); AISI S2;
- 1/4" (6.3 mm): PH1, PH2, PH3 (L=25 mm); AISI S2;
- 1/4" (6.3 mm): T8, T10, T15, T20, T25, T27 (L=25 mm); AISI S2;
- 1/4" (6.3 mm): 2, 2.5, 3, 4, 5, 6 mm (L=25 mm); AISI S2;
- 160 mm; 160 mm; 200 mm; 300 g (L=300 mm);
- 3 m x 16 mm; 18 mm; SK2; 1/4" (6.3 mm); CrV;
- 5x75, 6x100, PH2x100 mm; S2; 1.5, 2, 2.5, 3, 4, 5, 6, 8, 10 mm; CrV 6150



NYLON BAG & COLOR BOX

YATO		
YT-39280	1/4" (6.3 mm)	4

- GB Tool set
- D Sechskant-Steckschlüssel-Satz
- PL Zestaw narzędziowy
- RUS Набор инструмента
- CZ Sada nástrčných kľučí a ráčny
- H Dugókulcs készlet racsnis hajtókarral
- RO Trusa de scule
- F Coffret d'outillage
- I Set di utensili
- E Juego de herramientas
- CN 套筒扳手组套

BMC & COLOR SLEEVE



88 PCS	1/4" 6.3mm	CrV 50BV30
CrV 6150	CrV 6140	S2
Mn 65	72T	AS-DRIVE



- 1/4" (6.3 mm): 4, 4.5, 5, 5.5, 6, 7, 8, 9, 10, 11, 12, 13, 14 mm (L=25 mm); CrV 50BV30;
- 1/4" (6.3 mm): (50.8 mm); CrV 50BV30;
- 1/4" (6.3 mm): (150 mm); CrV 6140;
- 1/4" (6.3 mm): (152.4 mm); CrV 50BV30;
- 1/4" (6.3 mm): (155 mm); 72T; CrV 6140;
- 1/4" (6.3 mm): (150 mm); CrV 50BV30;
- 1/4" (6.3 mm) x 1/4" (6.3 mm); CrV 6140;
- 1/4" (6.3 mm): 3, 4, 5 mm (L=50 mm); AISI S2;
- 1/4" (6.3 mm): PH1, PH2, PH3 (L=50 mm); AISI S2;
- 1/4" (6.3 mm): PZ1, PZ2 (L=50 mm); AISI S2;
- 1/4" (6.3 mm): T10, T15, T20, T25, T27, T30 (L=50 mm); AISI S2;
- 1/4" (6.3 mm): 3, 4, 5, 6 mm (L=50 mm); AISI S2;
- 1/4" (6.3 mm): 3, 4, 5, 6 mm (L=25 mm); AISI S2;
- 1/4" (6.3 mm): PH0, PH1, PH2 (L=25 mm); AISI S2;
- 1/4" (6.3 mm): PZ0, PZ1, PZ2 (L=25 mm); AISI S2;
- 1/4" (6.3 mm): T10, T15, T20, T25, T27, T30 (L=25 mm); AISI S2;
- 1/4" (6.3 mm): 3, 4, 5, 6 mm (L=25 mm); AISI S2;
- 1/4" (6.3 mm): 4, 5.5 mm (L=37 mm); AISI S2 / CrV 6150;
- 1/4" (6.3 mm): PH1, PH2, PH3 (L=37 mm); AISI S2 / CrV 6150;
- 1/4" (6.3 mm): T15, T20 (L=37 mm); AISI S2 / CrV 6150;
- 1/4" (6.3 mm): 3, 4 mm (L=37 mm); AISI S2 / CrV 6150;
- 2x50, 2.4x50, 6x38, 6x100, PH0x50, PH1x50, PH2x38, PH2x100 mm; S2;
- 140 mm; 160 mm; 150 mm; 250 mm; 300 g; 125 mm, 65 Mn; 65 Mn; 3 m x 16 mm; 230 mm; 1.5, 2, 2.5; CrV 6150

YATO		
YT-38928	1/4" (6.3 mm)	2

GB Tool set for electricians
D Werkzeug-Set für Elektriker
PL Zestaw narzędziowy dla elektryków
RUS Набор инструментов для электриков
CZ Sada nářadí pro elektrikáře

H Szerszámkészlet villanyszerelők
RO Trusa electrician
F Un ensemble d'outils pour les électriciens

I Set per l'elettricista
E Um conjunto de ferramentas para electricistas
CN 件电子绝缘工具组套

BMC & COLOR SLEEVE



68 PCS
1/4" 6.3mm
CrV 50BV30
CrV 6150
S2
1000 V
D+E



- 1/4" (6.3 mm): 4, 4.5, 5, 5.5, 6, 7, 8, 9, 10, 11, 12, 13 mm (L=25 mm); CrV 50BV30;
140 mm; 190 mm; 3CRB; 150 mm;
160 mm; 1000 V; CrV; 160 mm; 1000 V; CrV;
3 m x 16 mm; 175 mm; 19.5 x 190 mm;
1.5 V; 9 LED; 9 mm; 19 mm x 20 mm;
1/4" (6.3 mm); (150 mm); CrV 50BV30;
1/4" (6.3 mm) x 1/4" (6.3 mm); CrV 6140; 10 g;
1.4, 2, 2.4 mm; PH00, PH0, PH1; S2;
4x75, 5.5x125, PH1x80, PH2x100 mm; 1000V; S2;
1/4" (6.3 mm): 3, 4, 5, 5.5, 6 mm (L=25 mm); AISI S2;
1/4" (6.3 mm): PH1, PH2, PH3 (L=25 mm); AISI S2;
1/4" (6.3 mm): T8, T10, T15, T20, T25, T27 (L=25 mm); AISI S2;
1/4" (6.3 mm): 2, 2.5, 3, 4, 5, 6 (L=25 mm); AISI S2;
1.5, 2, 2.5, 3, 4, 5, 6, 7, 8, 10 mm; CrV 6150

U 0-500 V
U 0-500 V
I 0-5 A
R 0-2 MΩ
hFE PNP NPN
5V P-P
12-250 Hz
50-500 Hz
LCD DISPLAY
NO BATTERY NEEDED
30W
230V-50Hz
400°C
TIP 3.6x76 mm

YATO	1/4" (6.3 mm)	2
YT-39009	1/4" (6.3 mm)	2

GB Torx socket
D Torx-Steckschlüssel
PL Nasadka Torx
RUS Головка
CZ Nástrčné klíče
H Hatszögű rátét Torx

RO Cheie tubulară Torx
F Douille Torx
I Bullone Torx
E Boquilla Torx
CN 星型套筒

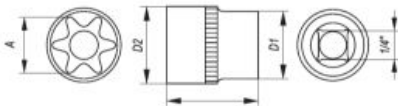

COLOR BOX



1/4" 6.3mm
TORX
CrV 50BV30

YATO	A (mm)	D1 (mm)	D2 (mm)	L (mm)	PCS packing	
YT-05211	E4	11.9	6.7	25	24	240/480
YT-05212	E5	11.9	7.2	25	24	240/480
YT-05213	E6	11.9	8.3	25	24	240/480
YT-05214	E7	11.9	9.4	25	24	240/480
YT-05215	E8	11.9	10.0	25	24	240/480

GB Torx socket set
D Torx-Steckschlüsselsatz
PL Klucze nasadowe Torx
RUS Набор головок
CZ Nástrčné klíče
H Dugókulcs
RO Trusa tubulare

F Clés à tube
I Chiavi a bussola bulloni Torx
E Llaves de vaso
CN 星型套筒组套



SLIDING CARD



9 PCS
TORX
CrV 50BV30

1/4" (6.3 mm): E5, E6, E7, E8, 3/8" (9.5 mm): E10, E12, E14, E16;
1/4" (6.3 mm) (M) x 3/8" (9.5 mm) (F)

YATO	1/4" (6.3 mm)	10/40
YT-0520	1/4" (6.3 mm)	10/40

GB Torx socket
D Torx-Steckschlüssel
PL Nasadka Torx
RUS Головка

CZ Nástrvec Torx
H Hatszögű rátét Torx
RO Cheie tubulară Torx
F Douille Torx

I Bullone Torx
E Boquilla Torx
CN 星型套筒

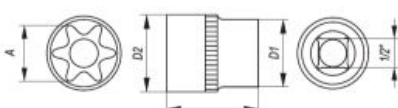

COLOR BOX



1/2" 12.5mm
TORX
CrV 50BV30

YATO	A (mm)	D1 (mm)	D2 (mm)	L (mm)	PCS packing	
YT-05220	E10	21.8	13.1	38	12	120/240
YT-05221	E11	21.8	13.9	38	12	120/240
YT-05222	E12	21.8	14.9	38	12	120/240
YT-05223	E14	21.8	16.3	38	12	120/240
YT-05224	E16	21.8	18.2	38	12	120/240
YT-05225	E18	23.8	19.4	38	12	120/240
YT-05226	E20	21.8	23.9	38	12	120/240
YT-05227	E22	23.2	25.7	38	12	120/240
YT-05228	E24	23.8	27.8	38	12	60/120

GB Torx socket set
D Torx-Steckschlüsselsatz
PL Klucze nasadowe Torx
RUS Набор головок
CZ Nástrčné klíče
H Dugókulcs
RO Trusa tubulare

F Clés à tube
I Chiavi a bussola bulloni Torx
E Llaves de vaso
CN 星型套筒组套



9 PCS
TORX
CrV 50BV30

METAL CASE & COLOR SLEEVE



1/2" (12.7 mm): E10, E11, E12, E14, E16, E18, E20, E22, E24

YATO	1/2" (12.7 mm)	20
YT-0521	1/2" (12.7 mm)	20

- GB Hexagonal socket
- D Sechskantenschlüssel
- PL Nasadka sześciokątna
- RUS Головка шестигранная
- CZ Šestihranný nástavec
- H Hatszögű rátét
- RO Cheie tubulară hexagonală
- F Douille 6 pans
- I Chiave a bussola esagonale
- E Boquilla hexagonal
- CN 六角套筒

- application: industry, car service stations and workshops
- for high loads
- drive locks
- surface finish: chromed, satin
- przeznaczenie: przemysł, serwisy i warsztaty
- do największych obciążeń
- zamki blokujące
- wykończenie powierzchni: chromowana, satynowa

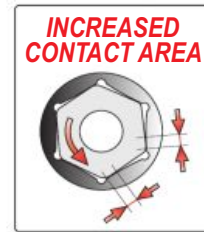
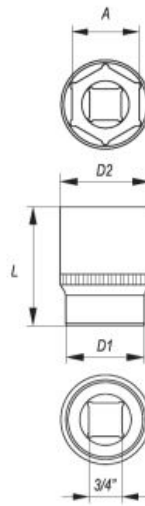

3/4" 19mm
DIN 3121
CrV 50BV30
AS-DRIVE

COLOR BOX



YATO	Ø A (mm)	D1 (mm)	D2 (mm)	L (mm)	PCS packing	
YT-1301	19	30	36	50	12	96
YT-1302	21	32	36	50	12	96
YT-1303	22	32	36	50	12	96
YT-1304	23	34	36	50	12	96
YT-1305	24	34	36	50	12	96
YT-1306	25	36	36	50	12	96
YT-1307	26	37	34	50	12	96
YT-1308	27	38	34	50	12	96
YT-1309	28	40	34	50	12	96
YT-1310	29	40	35	50	12	96
YT-1311	30	42	36	55	8	48
YT-1312	32	44	37	55	8	48
YT-1313	33	46	38	55	8	48

YATO	Ø A (mm)	D1 (mm)	D2 (mm)	L (mm)	PCS packing	
YT-1314	34	47	38	55	8	48
YT-1315	35	48	42	60	6	36
YT-1316	36	50	42	60	6	36
YT-1317	38	52	45	60	6	36
YT-1318	41	56	45	65	4	32
YT-1319	42	57	45	65	4	32
YT-1320	43	58	45	65	4	32
YT-1322	46	62	48	70	4	32
YT-1323	48	64	48	70	4	24
YT-1324	50	68	48	70	4	24
YT-1326	52	70	48	70	4	20
YT-1328	55	73	48	75	4	20
YT-1330	60	80	48	80	4	20

- GB Extension bar
- D Verlängerung
- PL Przedłużka
- RUS Удлинитель для воротка
- CZ Prodlužovací příravek
- H Toldalék
- RO Prelungitor
- F Rallonge
- I Prolunga
- E Tubo de prolongación
- CN 接杆

3/4" 19mm
DIN 3121
CrV 50BV30

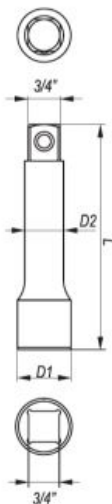

COLOR BOX



YATO	Ø	D1 (mm)	D2 (mm)	L (mm)	PCS packing	
YT-1340	3/4" (19.0 mm)	36	22	100	6	36
YT-1341	3/4" (19.0 mm)	36	22	200	5	20
YT-1342	3/4" (19.0 mm)	36	22	400	5	10

- GB Sliding T-bar
- D Handgriff mit Gleitstück
- PL Pokrętko typu „T”
- RUS Вороток Т-образный
- CZ Otočná ráčka typ „T”
- H „T” alakú hajtókar
- RO Mâner clupă tipul „T”
- E Mango tipo „T”
- F Barre type „T”
- I Manopola „T” scorrevole
- CN 滑行杆



3/4" 19mm
DIN 3121
CrV 50BV30

COLOR BOX



YATO	Ø	D1 (mm)	D2 (mm)	L (mm)	PCS packing	
YT-1350	3/4" (19.0 mm)	37	20	500	5	10

- GB Adapter
- D Reduktion
- PL Redukcja
- RUS Переходник
- CZ Redukce
- H Redukció
- RO Reducție
- F Réduction
- I Riduttore
- E Reducción
- CN 转换头

3/4" 19mm
DIN 3121
CrV 50BV30

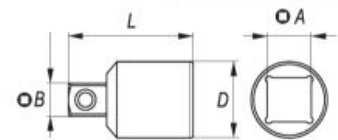

COLOR BOX



YATO	Ø A	Ø B	D (mm)	L (mm)	PCS packing	
YT-1355	3/4" (19.0 mm) (F) 1/2" (12.7 mm) (M)		36	53	12	48

- GB Universal joint
- D Kardangelenk
- PL Przegub Cardana
- RUS Карданный шарнир
- CZ Kardanový kloub
- H Kardan csukló
- RO Articulație Cardanică
- F Cardan
- I Snodo cardanico
- E Articulación Cardan
- CN 万向接头

3/4" 19mm
DIN 3121
CrV 50BV30

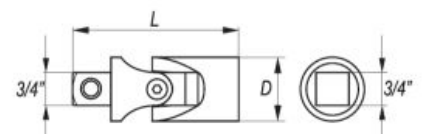

COLOR BOX



YATO	Ø	D (mm)	L (mm)	PCS packing	
YT-1352	3/4" (19.0 mm)	40	106	12	36

- GB Flexible handle
D Gelengriff
PL Pokręto łamane
RUS Вороток шарнирный
CZ Otočná lomená ráčka
H Hajlított hajtókar
RO Prelungitor
cu prindere flexibilă
F Barre pivotante
I Manopola a snodo
E Mango articulado
CN 转向手柄

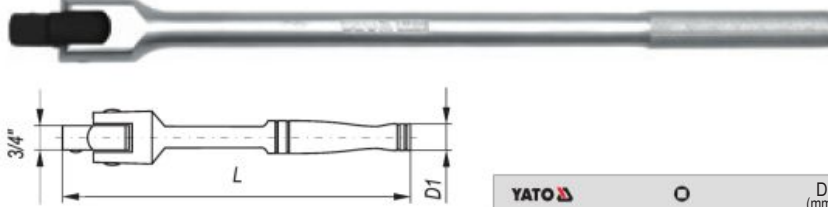

3/4"
19mm
DIN 3121
CrV 50BV30



YATO	Ø	D (mm)	L (mm)	PCS packing	Box
YT-1345	3/4" (19.0 mm)	25	507	5	10

- GB L-type handle
D Admutter Schlüssel
PL Pokręto typu „L”
RUS Вороток тип „L”
CZ Páka zahnutá
H „L” alakú hajtókar
RO Antrenor tip „L”
F Barre type „L”
I Leva tipo „L”
E Mango tipo „L”
CN L型套筒扳手

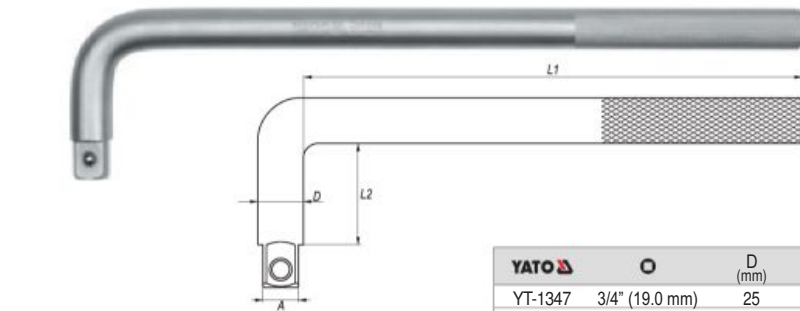

3/4"
19mm
DIN 3121
CrV 50BV30



YATO	Ø	D (mm)	L1 (mm)	L2 (mm)	PCS packing	Box
YT-1347	3/4" (19.0 mm)	25	360	75	5	10
YT-1348	3/4" (19.0 mm)	25	410	75	5	10

- GB L-type handle
D Admutter Schlüssel
PL Pokręto typu „L”
RUS Вороток тип „L”
CZ Páka zahnutá
H „L” alakú hajtókar
RO Antrenor tip „L”
F Barre type „L”
I Leva tipo „L”
E Mango tipo „L”
CN L型套筒扳手



3/4"
19mm
DIN 3122
CrV 50BV30



YATO	Ø	D (mm)	L1 (mm)	L2 (mm)	PCS packing	Box
YT-13465	3/4" (19.0 mm)	25	275	75	2	12
YT-13475	3/4" (19.0 mm)	25	373	75	2	8
YT-13490	3/4" (19.0 mm)	25	578	75	2	8

- GB Quick release ratchet handle
D Hebelumschaltknarre
PL Grzechotka
RUS Трещотка
CZ Řehtačka
H Racsnis hajtókar
RO Antrenor cu clichet
F Clé à cliquet
I Cricchetto bussola
E Carraca
CN 快速脱落棘轮扳手



3/4"
19mm
DIN 3122
24T
QUICK RELEASE SZYBKO-ZŁĄCZCE
CrV 6140



YATO	Ø	T	L (mm)	Box
YT-1360	3/4" (19.0 mm)	24	625	10

- GB Socket set
D Sechskant-Steckschlüssel-Satz
PL Komplet nasadek z akcesoriami
RUS Набор насадок
CZ Sada nástrčných klíčů a ráčny
H Dugókulcs készlet racsnis hajtókarral
RO Trusa chei tubulare cu antrenor
F Clé à cliquet
I Cricchetto bussola
E Juego de boquillas con accesorios
CN 套筒扳手组套



3/4"
19mm
CrV 50BV30
CrV 6140

QUICK RELEASE SZYBKO-ZŁĄCZCE
24T

15 PCS
AS-DRIVE

3/4" (19.0 mm): 30, 32, 34 (L=55 mm); 36, 38 (L=60 mm); 41 (L=65 mm); 46, 50 (L=70 mm); 55 (L=75 mm); 60 mm (L=80 mm); CrV 50BV30; 3/4" (19.0 mm); (L=500 mm); 24T; CrV 6140; 3/4" (19.0 mm); (L=500 mm); CrV 50BV30; 3/4" (19.0 mm); (L=100, 200 mm); CrV 50BV30; 3/4" (19.0 mm); (L=106 mm); CrV 50BV30

YATO	Ø	Box
YT-1334	3/4" (19.0 mm)	1

20 PCS

3/4" (19.0 mm): 19, 21, 22, 24 mm (L=50 mm); 26, 27, 28 mm (L=52 mm); 30, 32 mm (L=53 mm); 33, 34 mm (L=56 mm); 36 mm (L=58 mm); 38 mm (L=60 mm); 41 mm (L=64 mm); 46 mm (L=68 mm); 50 mm (L=72 mm); CrV 50BV30; 3/4" (19.0 mm) x 620 mm; CrV 6140; 3/4" (19.0 mm); (L=500 mm); CrV 50BV30; 3/4" (19.0 mm) x 100 mm, 3/4" (19.0 mm) x 200 mm; CrV 50BV30

YATO	Ø	Box
YT-1335	3/4" (19.0 mm)	1

- GB Star bit sockets
 D Aufsteckschlüssel
 PL Klucze trzpieniowe
 RUS Набор головок-вставок
 CZ Čepové klíče
 H Csapkulcs
- RO Chei cu cozi
 F Douille tournevis
 I Chiavi a bussola
 E Llaves de mandril
 CN 星型旋具套筒



PLASTIC HANGER



1/4"
6.3mm

AISI S2

CrV 6150

HRC 58-62

DIN 3120



YATO	Ø	☆	L (mm)	torque / moment obrotowy max. (Nm)	📦
YT-04301	1/4" (6.3 mm)	T8	37	2.6	150/600
YT-04302	1/4" (6.3 mm)	T10	37	4.6	150/600
YT-04303	1/4" (6.3 mm)	T15	37	7.7	150/600
YT-04304	1/4" (6.3 mm)	T20	37	12.7	150/600
YT-04305	1/4" (6.3 mm)	T25	37	19.0	150/600
YT-04306	1/4" (6.3 mm)	T30	37	37.4	150/600
YT-04307	1/4" (6.3 mm)	T40	37	65.0	150/600

YATO	Ø	⬡	L (mm)	torque / moment obrotowy max. (Nm)	📦
YT-04370	1/4" (6.3 mm)	3	37	6.6	150/600
YT-04371	1/4" (6.3 mm)	4	37	16.0	150/600
YT-04372	1/4" (6.3 mm)	5	37	30.0	150/600
YT-04373	1/4" (6.3 mm)	6	37	52.2	150/600
YT-04374	1/4" (6.3 mm)	7	37	78.0	150/600
YT-04375	1/4" (6.3 mm)	8	37	120.0	150/600

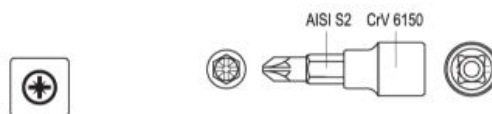

YATO	Ø	⊕	L (mm)	torque / moment obrotowy max. (Nm)	📦
YT-04411	1/4" (6.3 mm)	PH1	37	3.5	150/600
YT-04412	1/4" (6.3 mm)	PH2	37	8.2	150/600
YT-04413	1/4" (6.3 mm)	PH3	37	19.5	150/600

YATO	Ø	⊕	L (mm)	torque / moment obrotowy max. (Nm)	📦
YT-04417	1/4" (6.3 mm)	PZ1	37	3.5	150/600
YT-04418	1/4" (6.3 mm)	PZ2	37	8.2	150/600

- GB Insulated star bit socket
 D Aufsteckschlüssel vollisoliert
 PL Klucze trzpieniowe izolowane
 RUS Головка торцевая с вставкой hex изолированная
 CZ Čepové klíče izolované
 H Csapkulcs
 RO Chei cu cozi izolat
 F Douille tournevis isolée
 I Chiave esagonale isolato
 E Llaves de mandril aislante
 CN 绝缘套筒批

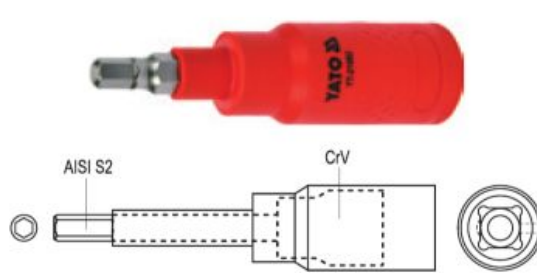

POLYBAG



3/8"
10mm

CrV

1000 V

D'E

1000V
 VDE CERTIFICATE
 EN 60900:2012

YATO	Ø	⬡	L (mm)	torque / moment obrotowy max. (Nm)	📦
YT-21080	3/8" (9.5 mm)	4	75	16.0	12/144
YT-21081	3/8" (9.5 mm)	5	75	30.0	12/144
YT-21082	3/8" (9.5 mm)	6	75	52.0	12/144
YT-21083	3/8" (9.5 mm)	8	75	120.0	12/144

- GB Star bit sockets
 D Aufsteckschlüssel
 PL Klucze trzpieniowe
 RUS Набор головок-вставок
 CZ Čepové klíče
 H Csapkulcs
- RO Chei cu cozi
 F Douille tournevis
 I Chiavi a bussola
 E Llaves de mandril
 CN 星型旋具套筒



PLASTIC HANGER



1/2"
12.5mm

AISI S2

CrV 6150

HRC 58-62

DIN 3120

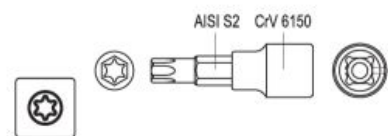
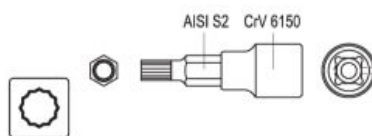
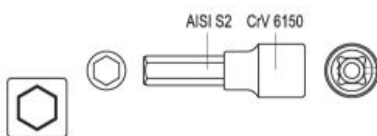

YATO	Ø	⬡	L (mm)	torque / moment obrotowy max. (Nm)	📦
YT-04381	1/2" (12.7 mm)	5	55	30.0	40/240
YT-04382	1/2" (12.7 mm)	6	55	52.0	40/240
YT-04383	1/2" (12.7 mm)	7	55	78.0	40/240
YT-04384	1/2" (12.7 mm)	8	55	120.0	40/240
YT-04385	1/2" (12.7 mm)	10	55	220.0	40/160
YT-04386	1/2" (12.7 mm)	12	55	370.0	40/160
YT-04387	1/2" (12.7 mm)	14	55	590.0	40/160
YT-04388	1/2" (12.7 mm)	17	55	1000.0	40/160

YATO	Ø	⬡	L (mm)	torque / moment obrotowy max. (Nm)	📦
YT-04341	1/2" (12.7 mm)	M6	55	30.0	40/240
YT-04342	1/2" (12.7 mm)	M8	55	52.0	40/240
YT-04343	1/2" (12.7 mm)	M10	55	120.0	40/160
YT-04344	1/2" (12.7 mm)	M12	55	220.0	40/160
YT-04345	1/2" (12.7 mm)	M14	55	370.0	40/160
YT-04346	1/2" (12.7 mm)	M16	55	590.0	40/160

YATO	Ø	☆	L (mm)	torque / moment obrotowy max. (Nm)	📦
YT-04310	1/2" (12.7 mm)	T20	55	12.7	40/240
YT-04311	1/2" (12.7 mm)	T25	55	19.0	40/240
YT-04312	1/2" (12.7 mm)	T27	55	27.0	40/240
YT-04313	1/2" (12.7 mm)	T30	55	37.4	40/240
YT-04314	1/2" (12.7 mm)	T40	55	65.0	40/240
YT-04315	1/2" (12.7 mm)	T45	55	103.5	40/240
YT-04316	1/2" (12.7 mm)	T50	55	159.0	40/240
YT-04317	1/2" (12.7 mm)	T55	55	257.0	40/240
YT-04318	1/2" (12.7 mm)	T60	55	445.0	40/240
YT-04319	1/2" (12.7 mm)	T70	55	700.0	40/160

- GB Star bit sockets
D Aufsteckschlüssel
PL Klucze trzpieniowe
RUS Набор головок-вставок
CZ Čepové klíče
H Csapkulcs
- RO Chei cu cozi
F Douille tournevis
I Chiavi a bussola
E Llaves de mandril
CN 星型旋具套筒



PLASTIC HANGER

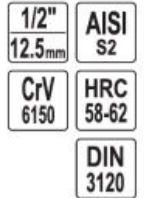

YATO	Ø	Ø L (mm)	torque / moment obrotowy max. (Nm)	📦
YT-04390	1/2" (12.7 mm)	4	100	16.0 20/120
YT-04391	1/2" (12.7 mm)	5	100	30.0 20/120
YT-04392	1/2" (12.7 mm)	6	100	52.0 20/120
YT-04393	1/2" (12.7 mm)	7	100	78.0 20/120
YT-04394	1/2" (12.7 mm)	8	100	120.0 20/120
YT-04395	1/2" (12.7 mm)	10	100	220.0 20/120
YT-04396	1/2" (12.7 mm)	12	100	370.0 20/120
YT-04397	1/2" (12.7 mm)	14	100	590.0 20/120
YT-04398	1/2" (12.7 mm)	17	100	1000.0 20/120

YATO	Ø	⚙️ L (mm)	torque / moment obrotowy max. (Nm)	📦
YT-04320	1/2" (12.7 mm)	T20	100	12.7 20/120
YT-04321	1/2" (12.7 mm)	T25	100	19.0 20/120
YT-04322	1/2" (12.7 mm)	T27	100	27.0 20/120
YT-04323	1/2" (12.7 mm)	T30	100	37.4 20/120
YT-04324	1/2" (12.7 mm)	T40	100	65.0 20/120
YT-04325	1/2" (12.7 mm)	T45	100	103.5 20/120
YT-04326	1/2" (12.7 mm)	T50	100	159.0 20/120
YT-04327	1/2" (12.7 mm)	T55	100	257.0 20/120
YT-04328	1/2" (12.7 mm)	T60	100	445.0 20/120
YT-04329	1/2" (12.7 mm)	T70	100	700.0 20/120

YATO	Ø	Ø L (mm)	torque / moment obrotowy max. (Nm)	📦
YT-04350	1/2" (12.7 mm)	M5	100	16.0 20/120
YT-04351	1/2" (12.7 mm)	M6	100	30.0 20/120
YT-04352	1/2" (12.7 mm)	M8	100	52.0 20/120
YT-04353	1/2" (12.7 mm)	M10	100	120.0 20/120
YT-04354	1/2" (12.7 mm)	M12	100	220.0 20/120
YT-04355	1/2" (12.7 mm)	M14	100	370.0 20/120
YT-04356	1/2" (12.7 mm)	M16	100	590.0 20/120
YT-04357	1/2" (12.7 mm)	M17	100	590.0 20/120

- GB Insulated star bit socket
D Aufsteckschlüssel vollisoliert
PL Klucze trzpieniowe izolowane
RUS Головка торцевая с вставкой hex изолированная
CZ Čepové klíče izolované
H Csapkulcs
RO Chei cu cozi izolat
F Douille tournevis isolée
I Chiave esagonale isolato
E Llaves de mandril aislante
CN 绝缘套筒批

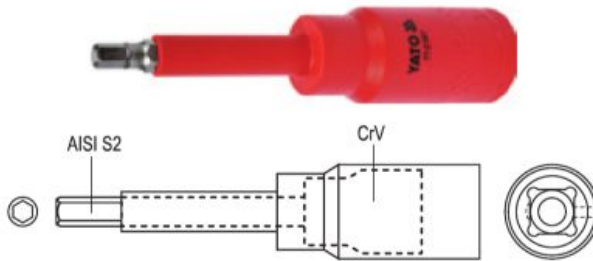

POLYBAG

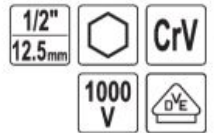

1000V VDE CERTIFICATE EN 60900:2012

YATO	Ø	Ø L (mm)	torque / moment obrotowy max. (Nm)	📦
YT-21085	1/2" (12.7 mm)	4	120	16.0 18/144
YT-21086	1/2" (12.7 mm)	5	120	30.0 18/144
YT-21087	1/2" (12.7 mm)	6	120	52.0 18/144
YT-21088	1/2" (12.7 mm)	8	120	120.0 18/144
YT-21089	1/2" (12.7 mm)	10	120	220.0 18/144

- GB Star bit sockets
D Aufsteckschlüssel
PL Klucze trzpieniowe
RUS Набор головок-вставок
CZ Čepové klíče
H Csapkulcs
- RO Chei cu cozi
F Douille tournevis
I Chiavi a bussola
E Llaves de mandril
CN 星型旋具套筒



SLIDING CARD



12 PCS 1/4" (6.3 mm): L=37 mm; T8, T10, T15, T20, T25, T27, T30
3/8" (9.5 mm): L=48 mm; T40, T45, T47, T50, T55

12 PCS 1/4" (6.3 mm): L=37 mm; T8, T10, T15, T20, T25, T27, T30
3/8" (9.5 mm): L=48 mm; T40, T45, T47, T50, T55

YATO	📦
YT-04331	10/40

YATO	📦
YT-04332	10/40



9 PCS 1/4" (6.3 mm): L=37 mm; 2, 3, 4, 5, 6 mm
3/8" (9.5 mm): L=48 mm; 7, 8, 10, 12 mm

5 PCS 1/4" (6.3 mm): L=37 mm; M5, M6
3/8" (9.5 mm): L=48 mm; M8, M10, M12

YATO	📦
YT-04401	6/36

YATO	📦
YT-04360	12/48

- GB Star bit sockets
- D Aufsteckschlüssel
- PL Klucze trzpieniowe
- RUS Набор головок-вставок
- CZ Čepové klíče
- H Csapkulcs
- RO Chei cu cozi
- F Douille tournevis
- I Chiavi a bussola
- E Llaves de mandril
- CN 星型旋具套筒



AISI S2
CrV 6150



7 PCS	1/4" 6.3mm	DIN 3120	TORX SPECIAL TAMPERPROOF
21.8 max.	AISI S2	HRC 58-62	TOYOTA VV

1/4" (6.3 mm): TS10; TS15; TS20; TS25; TS27; TS30; TS40 (L=35 mm)

YATO	
YT-0461	12/48

- GB Bit socket set
- CZ Čepové klíče
- I Chiavi a bussola a vite
- D Aufsteckschlüssel-Satz
- H Csapkulcs
- E Juego de llaves de mandril
- PL Zestaw kluczy trzpieniowych
- RO Chei cu cozi
- CN 套筒批头组套
- RUS Набор головок-вставок
- F Set de douilles tournevis



18 PCS	1/2" 12.5mm	1/4" 6.3mm
CrV 6150	HRC 58-62	
AISI S2	DIN 3120	



1/2" (12.7 mm): T30, T40, T45, T50, T55, T60 (L=50 mm);
T30, T40, T45, T50, T55, T60 (L=100 mm); AISI S2 / CrV 6150;
1/4" (6.3 mm): T10, T15, T20, T25, T30, T40 (L=37 mm); AISI S2 / CrV 6150

YATO		
YT-7751	1/2" (12.7 mm)	1/4" (6.3 mm)
		10



1/2" (12.7 mm): 5, 6, 7, 8, 10, 12 mm (L=50 mm);
5, 6, 7, 8, 10, 12 mm (L=100 mm); AISI S2 / CrV 6150;
1/4" (6.3 mm): 3, 4, 5, 6, 7, 8 mm (L=37 mm); AISI S2 / CrV 6150

YATO		
YT-7752	1/2" (12.7 mm)	1/4" (6.3 mm)
		10

- GB Bit socket set
- CZ Čepové klíče
- I Chiavi a bussola a vite
- D Aufsteckschlüssel-Satz
- H Csapkulcs
- E Juego de llaves de mandril
- PL Zestaw kluczy trzpieniowych
- RO Chei cu cozi
- CN 套筒批头组套
- RUS Набор головок-вставок
- F Set de douilles tournevis



12 PCS	1/2" 12.5mm	CrV 6150
HRC 58-62	AISI S2	
	DIN 3120	



1/2" (12.7 mm): M12, M17 (L=50 mm); M6 (L=70 mm); M7, M8 (L=100 mm);
M8, M10 (L=120 mm); M6, M10, M12 (L=140 mm); M5 (L=180 mm);
M6 (L=250 mm); AISI S2 / CrV 6150

YATO		
YT-7753	1/2" (12.7 mm)	10

Memo

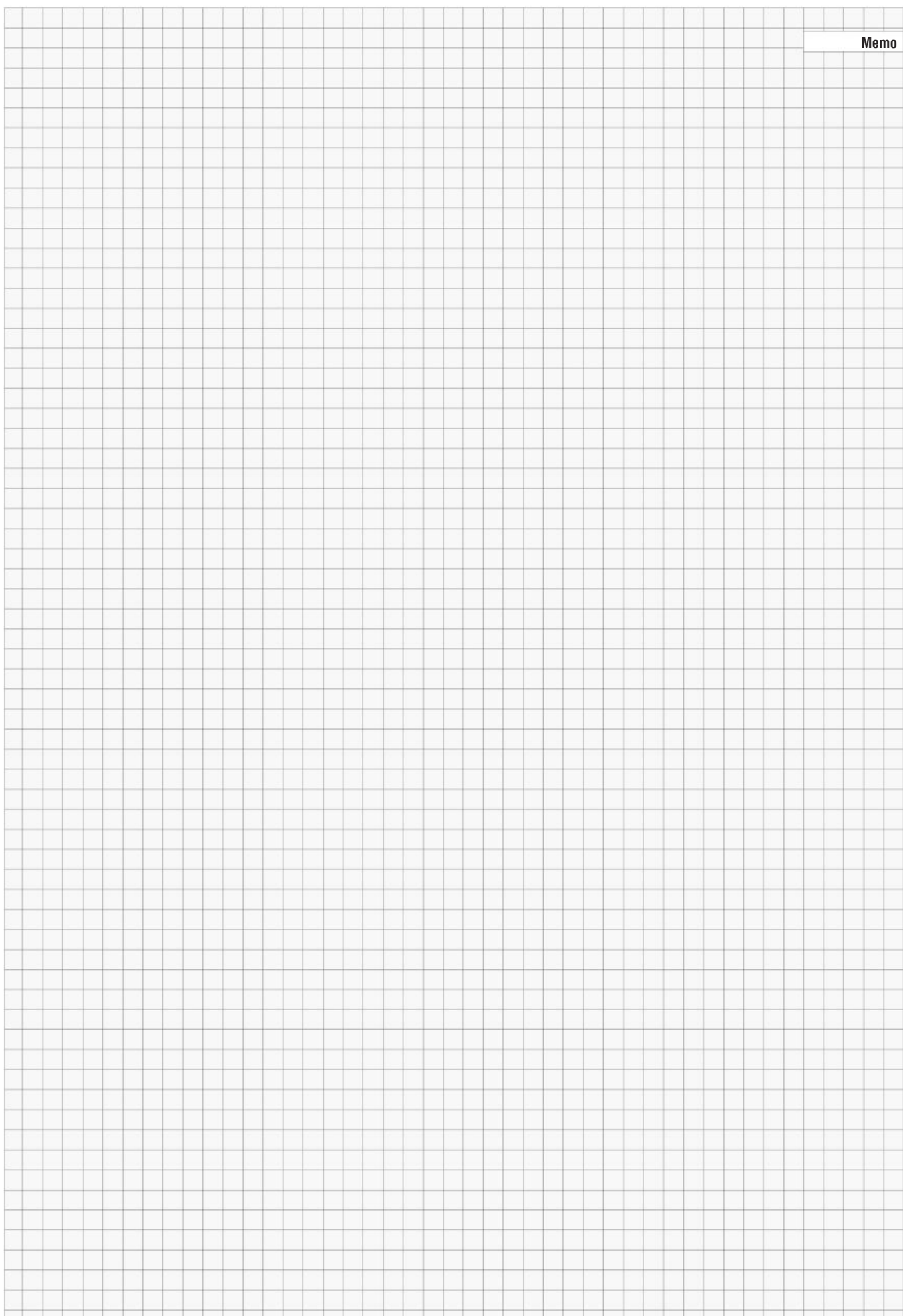

3

**Impact sockets,
accessories & sets**
**Udarowe klucze nasadowe,
akcesoria i zestawy**



Impact sockets 3/8" Klucze nasadowe udarowe 3/8"		58
--	---	----

Impact sockets 1" Udarowe klucze nasadowe 1"		61
--	---	----

Impact sockets sets Zestawy kluczy nasadowych udarowych krótkich	58
--	----

Impact sockets Klucze nasadowe udarowe, krótkie	61
---	----

Impact sockets 1/2" Klucze nasadowe udarowe 1/2"		58-59
--	---	-------

Deep impact sockets Klucze nasadowe udarowe, długie	61
---	----

Impact accessories 1" Akcesoria udarowe 1"		61
--	---	----

Impact sockets & sets Klucze nasadowe udarowe i zestawy, krótkie	58
Deep impact sockets & sets Klucze nasadowe udarowe i zestawy, długie	58

Impact extension bars with adapter Przedłużki udarowe z redukcją	61
--	----

Impact accessories 1/2" Akcesoria udarowe 1/2"		59
--	---	----

Impact sockets for front hub nuts Nasadki udarowe do piast		61-62
--	---	-------

Impact extension bars Przedłużki udarowe	59
Impact adapters Redukcje udarowe	59
Impact universal joints Przeguby kuliste udarowe	59

Impact bit socket sets 1/2" Zestawy udarowych kluczy trzpieniowych 1/2"		62
---	---	----

Impact sockets 3/4" Udarowe klucze nasadowe 3/4"		59-60
--	--	-------

Spline impact bit sets 3/4" Zestawy bitów udarowych „Spline” 3/4"		62
---	--	----

Impact sockets & sets Klucze nasadowe udarowe i zestawy, krótkie	59
Deep impact sockets & sets Klucze nasadowe udarowe i zestawy, długie	60

Impact accessories 3/4" Akcesoria udarowe 3/4"		60-61
--	---	-------

Impact extension bars Przedłużki udarowe	60
Impact adapters Redukcje udarowe	60
Impact universal joints Przeguby kuliste udarowe	61

- GB Impact socket set
- D Kraftschrauber-Einsätze
- PL Zestaw nasadek udarowych
- RUS Набор торцевых ударных головок
- CZ Sada nástrčných klíčů pro úderové utahováky
- H Dugófej készlet ütvebehajtóhoz
- RO Set chei tubulare pt. impact
- F Douille profonde à choc
- I Chiave a bussola esagonale per percussione
- E Juego de boquillas de percusión cortas
- CN 风动套筒组套

METAL CASE & COLOR BOX



10 PCS 3/8" 10mm CrMo SCM-440



3/8" (9.5 mm): 10, 12, 13, 14, 15, 16, 17, 18, 19, 22 mm (L=39 mm)

YATO		
YT-37690	3/8" (9.5 mm)	20

- GB Hexagonal impact socket
- D Kraftschrauber-Einsatz
- PL Nasadka udarowa sześciokątna
- RUS Головка ударная 6-гранная
- CZ Šestihranný nástavec
- H Hatszögű rátét
- RO Cheie tubulară hexagonală de impact
- F Douille à choc
- I Chiave a bussola esagonale per percussione
- E Boquilla de percusión
- CN 六角风动套筒

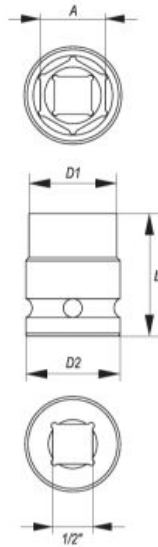

1/2" 12.5mm CrMo SCM-440 AS-DRIVE

YATO	Ø A (mm)	D1 (mm)	D2 (mm)	L (mm)	PCS packing:	
YT-1000	10	17.5	25.0	39	60	240
YT-1001	11	18.5	25.0	39	60	240
YT-1002	12	20.0	25.0	39	60	240
YT-1003	13	21.0	25.0	39	60	240
YT-1004	14	22.5	25.0	39	60	240
YT-1005	15	23.5	30.0	39	40	160
YT-1006	16	24.0	30.0	39	40	160
YT-1007	17	26.0	30.0	39	40	160
YT-1008	18	27.5	30.0	39	40	160
YT-1009	19	28.0	30.0	39	40	160
YT-1010	20	30.0	30.0	39	40	160
YT-1011	21	30.0	30.0	39	40	160
YT-1012	22	32.0	30.0	39	30	120
YT-1013	23	32.0	30.0	39	30	120
YT-1014	24	34.0	30.0	43	30	120
YT-1015	25	35.0	30.0	43	30	120
YT-1016	26	38.0	30.0	43	24	96
YT-1017	27	38.0	30.0	43	24	96
YT-1018	28	40.0	30.0	48	24	96
YT-1019	29	41.0	30.0	48	22	88
YT-1020	30	42.0	30.0	48	24	96
YT-1022	32	44.0	30.0	48	20	80

COLOR BOX



- GB Impact socket set
- D Kraftschrauber-Einsätze
- PL Zestaw nasadek udarowych
- RUS Набор торцевых ударных головок
- CZ Sada nástrčných klíčů pro úderové utahováky
- H Dugófej készlet ütvebehajtóhoz
- RO Set chei tubulare pt. impact
- F Douille profonde à choc
- I Chiave a bussola esagonale per percussione
- E Juego de boquillas de percusión cortas
- CN 风动套筒组套

METAL CASE & COLOR BOX



10 PCS 1/2" 12.5mm CrMo SCM-440 AS-DRIVE



1/2" (12.7 mm): 10, 12, 13, 14, 15, 16, 17, 18, 19, 22 mm (L=39 mm)

YATO		
YT-1025	1/2" (12.7 mm)	20

- GB Hexagonal deep impact socket
- D Kraftschrauber-Einsatz, lang
- PL Nasadka udarowa sześciokątna długa
- RUS Головка ударная 6-гранная глубокая
- CZ Šestihranný hluboký nástavec
- H Hatszögű rátét mély
- RO Cheie tubulară hexagonală de impact adâncă
- F Douille profonde à choc
- I Chiave a bussola esagonale per percussione
- E Boquilla de percusión profunda
- CN 六角风动长套筒

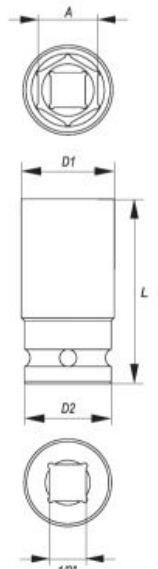

1/2" 12.5mm CrMo SCM-440 AS-DRIVE

YATO	Ø A (mm)	D1 (mm)	D2 (mm)	L (mm)	PCS packing:	
YT-1030	10	17.5	24.0	78	30	120
YT-1031	11	18.5	24.0	78	30	120
YT-1032	12	20.0	24.0	78	30	120
YT-1033	13	21.0	24.0	78	30	120
YT-1034	14	22.0	24.0	78	30	120
YT-1035	15	23.7	24.0	78	30	120
YT-1036	16	24.0	24.0	78	30	120
YT-1037	17	26.0	26.0	78	25	100
YT-1038	18	28.0	28.0	78	24	96
YT-1039	19	28.0	28.0	78	24	96
YT-1040	20	30.0	30.0	78	20	80
YT-1041	21	30.0	30.0	78	20	80
YT-1042	22	32.0	30.0	78	18	72
YT-1043	23	32.0	30.0	78	15	60
YT-1044	24	34.0	30.0	78	15	60
YT-1045	25	35.0	30.0	78	15	60
YT-1046	26	38.0	30.0	78	12	48
YT-1047	27	38.0	30.0	78	12	48
YT-1048	28	40.0	30.0	78	12	48
YT-1049	29	41.0	30.0	78	10	40
YT-1050	30	42.0	30.0	78	10	40
YT-1052	32	44.0	30.0	78	10	40

COLOR BOX



GB Impact socket set
D Kraftschrauber-Einsätze
PL Zestaw nasadek udarowych
RUS Набор торцевых ударных головок
CZ Sada nástrčných klíčů pro úderové utahováky

H Dugófej készlet ütvebehajtóhoz
RO Set chei tubulare pt. impact
F Set de douilles à choc
I Chiave a bussola esagonale per percussione

E Juego de boquillas de percusión cortas
CN 风动套筒组套



1/2" 12.5mm CrMo SCM-440 AS-DRIVE



11 PCS 1/2" (12.7 mm): 10, 12, 13, 14, 15, 16, 17, 18, 19, 22, 24 mm (L=39 mm)

YATO	Ø	PCS
YT-1054	1/2" (12.7 mm)	10



15 PCS 1/2" (12.7 mm): 10, 12, 13, 14, 15, 16, 17, 18, 19, 21, 22, 24, 27, 30, 32 mm (L=39 mm)

YATO	Ø	PCS
YT-1055	1/2" (12.7 mm)	4

GB Impact extension bar
D Verlängerung
PL Przedłużka udarowa
RUS Удлинитель ударный
CZ Prodlužovací příravek
H Toldalék
RO Prelungitor
F Rallonge
I Prolunga per percussione
E Tubo de prolongación
CN 风动接杆

1/2" 12.5mm CrMo SCM-440

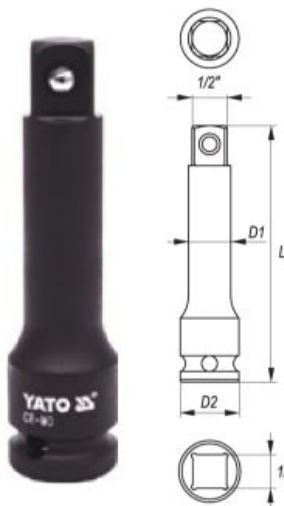

YATO	Ø	D1 (mm)	D2 (mm)	L (mm)	PCS packing	PCS
YT-1060	1/2" (12.7 mm)	17.5	25.0	75	40	160
YT-1061	1/2" (12.7 mm)	18.5	25.0	125	28	112
YT-1062	1/2" (12.7 mm)	20.0	25.0	250	30	60

GB Impact adapter
D Reduktion
PL Redukcja udarowa
RUS Переходник
CZ Redukce
H Redukció
RO Reducție
F Réduction
I Prolunga per percussione
E Reducción
CN 风动转换头

1/2" 12.5mm CrMo SCM-440



YATO	Ø	Ø	D (mm)	L (mm)	PCS packing	PCS
YT-1067	1/2" (12.7 mm) (F)	3/4" (19.0 mm) (M)	30	48	40	160

GB Impact universal joint
D Gelenkstück
PL Przegub kulisty udarowy
RUS Кардан ударный
CZ Kloub kulový
H Univerzális csuklós csatlakozó
RO Adaptor
F Flector rond
I Prolunga per percussione
E Articulación redonda
CN 风动万向接头

1/2" 12.5mm CrMo SCM-440



YATO	Ø	D1 (mm)	D2 (mm)	L (mm)	PCS packing	PCS
YT-1064	1/2" (12.7 mm)	31	17	63	25	100

GB Hexagonal impact socket
D Kraftschrauber-Einsatz
PL Nasadka udarowa sześciokątna
RUS Головка ударная 6-гранная
CZ Šestihranný nástavec
H Hatszögű rátét
RO Cheie tubulară hexagonală de impact
F Douille à choc
I Chiave a bussola esagonale per percussione
E Boquilla de percusión
CN 六角风动套筒

3/4" 19mm CrMo SCM-440 AS-DRIVE

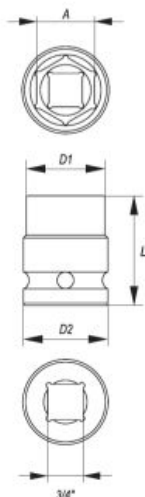

YATO	Ø A (mm)	D1 (mm)	D2 (mm)	L (mm)	PCS packing	PCS
YT-1070	19	32	40	50	16	64
YT-1071	21	35	40	50	16	64
YT-1072	22	38	40	50	16	64
YT-1073	23	38	40	50	16	64
YT-1074	24	40	40	50	16	64
YT-1075	25	40	40	50	16	64
YT-1076	26	40	40	50	16	64
YT-1077	27	42	42	53	16	64
YT-1078	28	44	44	53	16	64
YT-1079	29	46	44	53	12	48
YT-1080	30	46	44	53	12	48
YT-1082	32	48	44	56	10	40
YT-1083	33	48	44	56	8	32
YT-1084	34	50	44	56	8	32
YT-1085	35	50	44	56	6	24
YT-1086	36	52	44	56	6	24
YT-1088	38	56	44	57	6	24
YT-1091	41	60	44	57	5	20
YT-1092	42	61	44	57	4	16
YT-1093	43	63	44	57	4	16
YT-1096	46	66	44	62	3	12
YT-1100	50	71	54	72	3	12
YT-1102	52	74	54	72	2	8
YT-1105	55	78	54	74	2	8
YT-1110	60	84	54	74	2	8

GB Impact socket set
D Kraftschrauber-Einsätze
PL Zestaw nasadek uderowych
RUS Набор торцевых ударных головок

CZ Sada nástrčných kľúčů pro úderové utahováky
H Dugófej készlet ütvebehajtóhoz
RO Set chei tubulare pt. impact
F Set de douilles à choc

I Chiave a bussola esagonale per percussione
E Juego de boquillas de percusión cortas
CN 风动套筒组套



8 PCS 3/4" 19mm CrMo SCM-440 AS-DRIVE



3/4" (19.0 mm): 22, 24 mm (L=50 mm); 27, 30 mm (L=53 mm); 32, 36 mm (L=55 mm); 38, 41 mm (L=57 mm)

YATO	Ø	PCS
YT-1115	3/4" (19.0 mm)	6

GB Hexagonal deep impact socket
D Kraftschrauber-Einsatz, lang
PL Nasadka uderowa sześciokątna długa
RUS Головка ударная 6-гранная глубокая
CZ Šestihranný hluboký nástavec
H Hatszögű rátét mély
RO Cheie tubulară hexagonală de impact adâncă
F Douille profonde à choc
I Chiave a bussola esagonale per percussione
E Boquilla de percusión profunda
CN 六角风动长套筒

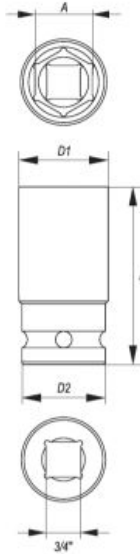

3/4" 19mm CrMo SCM-440 AS-DRIVE

YATO	Ø A (mm)	D1 (mm)	D2 (mm)	L (mm)	PCS packing	
YT-1119	19	32	44	90	9	36
YT-1121	21	35	44	90	9	36
YT-1122	22	38	44	90	9	36
YT-1123	23	38	44	90	9	36
YT-1124	24	40	44	90	9	36
YT-1127	27	42	44	90	9	36
YT-1128	28	44	44	90	8	32
YT-1129	29	44	44	90	8	32
YT-1130	30	46	44	90	7	28
YT-1132	32	48	44	90	7	28
YT-1133	33	50	44	90	6	24
YT-1134	34	51	44	90	6	24
YT-1135	35	52	44	90	6	24
YT-1136	36	54	44	90	6	24
YT-1138	38	56	44	90	6	24
YT-1141	41	60	44	90	5	20
YT-1142	42	61	44	90	4	16
YT-1143	43	63	44	90	3	12
YT-1146	46	66	44	90	3	12
YT-1148	48	68	44	90	2	8
YT-1150	50	71	54	90	2	8



GB Impact socket set
D Kraftschrauber-Einsätze
PL Zestaw nasadek uderowych
RUS Набор торцевых ударных головок

CZ Sada nástrčných kľúčů pro úderové utahováky
H Dugófej készlet ütvebehajtóhoz
RO Set chei tubulare pt. impact
F Set de douilles à choc

I Chiave a bussola esagonale per percussione
E Juego de boquillas de percusión cortas
CN 风动套筒组套



8 PCS 3/4" 19mm CrMo SCM-440 AS-DRIVE



3/4" (19.0 mm): 22, 24, 27, 30, 32, 36, 38, 41 mm (L=90 mm)

YATO	Ø	PCS
YT-1155	3/4" (19.0 mm)	4

GB Impact extension bar
D Verlängerung
PL Przedłużka uderowa
RUS Удлинитель ударный
CZ Prodlužovací příravek
H Toldalék
RO Prelungitor
F Rallonge
I Prolunga per percussione
E Tubo de prolongación
CN 风动接杆



3/4" 19mm CrMo SCM-440

YATO	Ø	D1 (mm)	D2 (mm)	L (mm)	PCS packing	
YT-1160	3/4" (19.0 mm)	44	24	100	8	32
YT-1161	3/4" (19.0 mm)	44	24	175	10	20
YT-1162	3/4" (19.0 mm)	44	24	250	8	16
YT-1163	3/4" (19.0 mm)	44	24	330	6	12

GB Impact adapter
D Reduktion
PL Redukcja uderowa
RUS Переходник
CZ Redukce
H Redukció
RO Reducție
F Réduction
I Prolunga per percussione
E Reducción
CN 风动转换头



3/4" 19mm CrV 50BV30



YATO	Ø	Ø	D (mm)	L (mm)	PCS packing	
YT-11671	3/4" (19.0 mm) (F)	1/2" (12.7 mm) (M)	44	55	12	48

GB Impact adapter
D Reduktion
PL Redukcja uderowa
RUS Переходник
CZ Redukce
H Redukció
RO Reducție
F Réduction
I Prolunga per percussione
E Reducción
CN 风动转换头



3/4" 19mm CrMo SCM-440



YATO	Ø	Ø	D (mm)	L (mm)	PCS packing	
YT-1168	3/4" (19.0 mm) (F)	1" (25.4 mm) (M)	44	63	12	48

GB Impact universal joint
D Gelenstück
PL Przegub kulisty udarowy
RUS Кардан ударный
CZ Kloub kulový
H Univerzális csuklós csatlakozó
RO Adaptor
F Flector rond
I Prolunga per percussione
E Articulación redonda
CN 风动方向接头

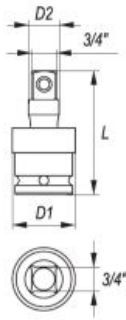

3/4"
19mm
CrMo
SCM-440

COLOR BOX



YATO	Ø	D1 (mm)	D2 (mm)	L (mm)	PCS packing	
YT-1164	3/4" (19.0 mm)	31	44	102	8	32

GB Hexagonal deep impact socket
D Kraftschrauber-Einsatz, lang
PL Nasadka udarowa sześciokątna długa
RUS Головка ударная 6-гранная глубокая
CZ Šestihránný hluboký nástavec
H Hatszögű rátét mély
RO Cheie tubulară hexagonală de impact adâncă
F Douille profonde à choc
I Chiave a bussola esagonale per percussione
E Boquilla de percusión profunda
CN 六角风动长套筒

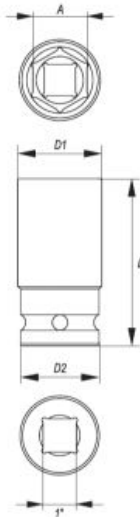

1"
25mm
CrMo
SCM-440
AS-DRIVE

COLOR BOX



YATO	Ø A (mm)	D1 (mm)	D2 (mm)	L (mm)	PCS packing	
YT-1175	27	46	54	90	6	24
YT-1176	30	50	54	90	6	24
YT-1177	32	52	54	90	6	24
YT-1178	33	54	54	90	6	24
YT-1179	36	57	54	90	6	24

GB Hexagonal impact socket
D Kraftschrauber-Einsatz
PL Nasadka udarowa sześciokątna
RUS Головка ударная 6-гранная
CZ Šestihránný nástavec
H Hatszögű rátét
RO Cheie tubulară hexagonală de impact
F Douille à choc
I Chiave a bussola esagonale per percussione
E Boquilla de percusión
CN 六角风动套筒

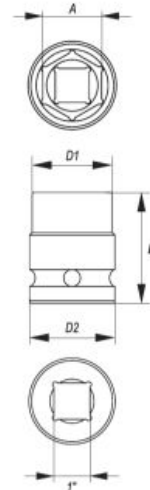

1"
25mm
CrMo
SCM-440
AS-DRIVE

COLOR BOX



YATO	Ø A (mm)	D1 (mm)	D2 (mm)	L (mm)	PCS packing	
YT-1180	24	42	54	59	6	24
YT-1183	27	46	54	59	6	24
YT-1184	28	47	54	59	6	24
YT-1185	29	48	54	60	6	24
YT-1186	30	49	54	60	6	24
YT-1187	32	52	54	61	6	24
YT-1188	33	53	54	61	6	24
YT-1189	34	54	54	61	6	24
YT-1191	36	57	54	65	6	24
YT-1193	38	60	54	65	5	20
YT-1194	41	63	54	65	4	16
YT-1196	46	69	54	73	3	12
YT-1197	48	72	54	73	2	8
YT-1198	50	75	54	73	2	8

GB Impact extension bar with adapter
D Verlängerung mit Adapter
PL Przedłużka udarowa z redukcją
RUS Удлинитель с редукцией
CZ Prodloužení s redukcí
H Hosszabbító szár adapterrel
RO Bara extensie cu adaptor
F Rallonge avec reduction
I Prolunga per percussione con riduttore
E Tubo de prolongación con reductor
CN 风动转换接头

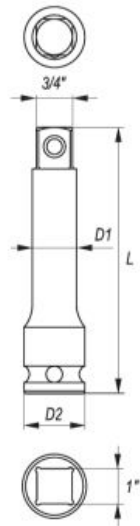

1"
25mm
CrMo
SCM-440

COLOR BOX



YATO	Ø A	Ø B	D1 (mm)	D2 (mm)	L (mm)	PCS packing	
YT-1169	1" (25.4 mm) (F)	3/4" (19.0mm) (M)	53	33	250	6	12

GB Hexagonal impact socket
D Kraftschrauber-Einsatz
PL Nasadka udarowa sześciokątna
RUS Головка ударная 6-гранная
CZ Šestihránný nástavec
H Hatszögű rátét
RO Cheie tubulară hexagonală de impact
F Douille à choc
I Chiave a bussola esagonale per percussione
E Boquilla de percusión
CN 六角风动套筒



1/2" FOR FRONT HUB NUTS DO PIAST
12.5mm
CrMo
SCM-440
AS-DRIVE

COLOR BOX



YATO	Ø A (mm)	D1 (mm)	D2 (mm)	L (mm)	PCS packing	
YT-1029	52	44	71	72	3	12

- GB Bi-hexagonal impact socket
- D Zwölfkant-Kraftschrauber-Einsatz
- PL Nasadka udarowa dwunastokątna
- RUS Головка ударная 12-гранная
- CZ Vanáčtíhřanný nástavec
- H Dugófej, 12 lapú
- RO Cheie tubulară bihexagonală de impact
- F Douille à choc
- I Chiave a bussola esagonale per percussione
- E Boquilla bihexagonal de percusión
- CN 风动套筒

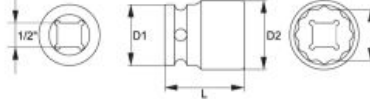

COLOR BOX



1/2"
12.5mm

FOR FRONT HUB NUTS DO PIAST

CrMo
SCM-440

AS-DRIVE

YATO	∅ A (mm)	D1 (mm)	D2 (mm)	L (mm)	PCS packing	Box
YT-1027	24	30	34	39	10	120

- GB Bi-hexagonal deep impact socket
- D Zwölfkant-Kraftschrauber-Einsatz, lang
- PL Nasadka udarowa dwunastokątna długa
- RUS Головка ударная 12-гранная глубокая
- CZ Vanáčtíhřanný hluboký nástavec
- H Dugófej, mély, 12 lapú
- RO Cheie tubulară bihexagonală de impact adâncă
- F Douille à choc
- I Chiave a bussola esagonale per percussione
- E Boquilla bihexagonal de percusión profunda
- CN 风动套筒

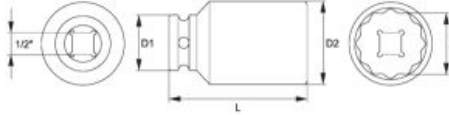

COLOR BOX



1/2"
12.5mm

FOR FRONT HUB NUTS DO PIAST

CrMo
SCM-440

AS-DRIVE

YATO	∅ A (mm)	D1 (mm)	D2 (mm)	L (mm)	PCS packing	Box
YT-1028	33	30	45	75	8	32

- GB Bi-hexagonal impact socket
- D Zwölfkant-Kraftschrauber-Einsatz
- PL Nasadka udarowa dwunastokątna
- RUS Головка ударная 12-гранная
- CZ Vanáčtíhřanný nástavec
- H Dugófej, 12 lapú
- RO Cheie tubulară bihexagonală de impact
- F Douille à choc
- I Chiave a bussola esagonale per percussione
- E Boquilla bihexagonal de percusión
- CN 风动套筒

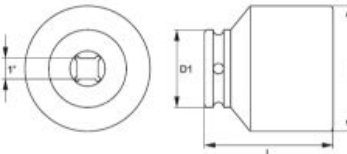

COLOR BOX



1"
25mm

FOR FRONT HUB NUTS DO PIAST

CrMo

HRC
38-45

YATO	∅ A (mm)	D1 (mm)	D2 (mm)	L (mm)	Box
YT-11990	65	54	93	93	4
YT-11995	80	86	112	100	4
YT-11998	85	86	118	102	4

- GB Impact bit socket set
- D Schlagsteckschlüsselsatz
- PL Zestaw udarowych kluczy trzpieniowych
- RUS Набор ударных торцевых ключей
- CZ Souprava rázových zástrčných klíčů
- H Ütőbit készlet
- RO Set chei de soc cu bolț
- F Set de douilles à choc
- I Set di chiavi a bussola per percussione
- E Juego de llaves de mandril de impacto
- CN 风动套筒批头组套

BMC & COLOR SLEEVE



8
PCS

1/2"
12.5mm

CrMo

HRC
54

T30, T40, T45, T50, T55, T60, TORX T70, T80



6, 7, 8, 10, 12, 14, 17, 19 mm
HEX



YATO	∅	Box
YT-1065	1/2" (12.7 mm)	15

YATO	∅	Box
YT-1066	1/2" (12.7 mm)	15

RM5, RM6, RM7, RM8, RM10, RM11, RIBE RM12, RM13



M5, M6, M8, M10, M12, M14, M16, M18
SPLINE



YATO	∅	Box
YT-1068	1/2" (12.7 mm)	15

YATO	∅	Box
YT-1069	1/2" (12.7 mm)	15

- GB Spline impact bit set
- D Schlagwerkzeugsatz - Spline
- PL Zestaw bitów udarowych - Spline
- RUS Набор ударных битов - Spline
- CZ Souprava bitů pro rázové utahováky - Spline
- H Ütőbit készlet - Spline
- RO Set tubulare de impact
- F Set d'embouts à choc
- I Set di chiavi a bussola per percussione Spline
- E Juego de las piezas de percusión - Spline
- CN 风动花键批头组套



BMC & COLOR BOX



6
PCS

3/4"
19mm

SPLINE (DIN)

CrMo



M12, M14, M16, M18 x 22 mm; (L=107 mm); CrMo;
3/4" (19.0 mm) x 22 mm; CrMo;

YATO	∅	Box
YT-1157	3/4" (19.0 mm)	8

Memo

4

Torque wrenches & torque multipliers Klucze dynamometryczne i wzmacniacze momentu



Torque wrenches Klucze dynamometryczne		66-68
--	---	-------

Torque angle gauges Kątomierze do dokręcania śrub		68
---	---	----

Beam torque wrenches Klucze dynamometryczne wychylne	66
Torque wrenches with metal handle Klucze dynamometryczne z metalową rączką	66
Torque wrenches with plastic handle Klucze dynamometryczne z plastikową rączką	66
Dial torque wrenches Klucze dynamometryczne zegarowe	68
Interchangeable torque handles Rękojeści klucza dynamometrycznego	68
Heads for torque wrenches Główce do klucza dynamometrycznego	68

Torque multipliers Wzmacniacze momentu		68-69
--	---	-------

GB Beam torque wrench
 D Beam-Typ-Drehmomentschlüssel
 PL Klucz dynamometryczny wychylny
 RUS Ключ динамометрический стрелочный

CZ Dynamometrický klíč
 H Nyomatékkulcs
 RO Cheie cu dinamometru
 F Clé dynamométrique inclinée

I Chiave dinamometrica a quadrante
 E Llave dinamoétrica inclinada
 CN 指针式扭力扳手

1/2" 12.5mm 3/4" 19mm CrV 6140



YATO	Ø	Nm	
YT-07641	1/2" (12.7 mm)	0-300	16
YT-07642	3/4" (19.0 mm)	0-500	9

COLOR BOX

4

GB Torque wrench
 D Drehmomentschlüssel
 PL Klucz dynamometryczny

RUS Ключ динамометрический
 CZ Dynamometrický klíč
 H Nyomatékkulcs

RO Cheie cu dinamometru
 F Clé dynamométrique
 I Chiave dinamometrica

E Llave dinamoétrica
 CN 传统型可调式扭力扳手

1/2" 12.5mm 3/8" 10mm CrV 6140



YATO	Ø	Nm	L (mm)	
YT-0750	3/8" (9.5 mm)	20-110	342-360	20
YT-0760	1/2" (12.7 mm)	42-210	445-465	12

BMC

GB Torque wrench
 D Drehmomentschlüssel
 PL Klucz dynamometryczny

RUS Ключ динамометрический
 CZ Dynamometrický klíč
 H Nyomatékkulcs

RO Cheie cu dinamometru
 F Clé dynamométrique
 I Chiave dinamometrica

E Llave dinamoétrica
 CN 传统型可调式扭力扳手

3/8" 10mm TOLERANCE TOLERANȚA CW +-4% CCW +-4% ALLOY STEEL STAL STOPWA



YATO	Ø	Nm	L (mm)	
YT-07500	3/8" (9.5 mm)	10-60	378-400	12

BMC

GB Torque wrench
 D Drehmomentschlüssel
 PL Klucz dynamometryczny
 RUS Ключ динамометрический

CZ Dynamometrický klíč
 H Nyomatékkulcs
 RO Cheie cu dinamometru
 F Clé dynamométrique

I Chiave dinamometrica
 E Llave dinamoétrica
 CN 传统型可调式扭力扳手

1/4" 6.3mm 1/2" 12.5mm 3/4" 19mm TOLERANCE TOLERANȚA CW +-4% ALLOY STEEL STAL STOPWA



YATO	Ø	Nm	L (mm)	
YT-07511	1/4" (6.3 mm)	2.5-20	240-250	16
YT-07611	1/2" (12.7 mm)	10-60	378-400	16
YT-07601	1/2" (12.7 mm)	65-335	518-540	16
YT-07712	3/4" (19.0 mm)	80-400	676-697	16

BMC

GB Torque wrench
 D Drehmomentschlüssel
 PL Klucz dynamometryczny

RUS Ключ динамометрический
 CZ Dynamometrický klíč
 H Nyomatékkulcs

RO Cheie cu dinamometru
 F Clé dynamométrique
 I Chiave dinamometrica

E Llave dinamoétrica
 CN 传统型可调式扭力扳手

1/4" 6.3mm CrV 6140



YATO	Ø	Nm	L (mm)	
YT-0751	1/4" (6.3 mm)	2-10	268-278	24

BMC

GB Torque wrench
 D Drehmomentschlüssel
 PL Klucz dynamometryczny

RUS Ключ динамометрический
 CZ Dynamometrický klíč
 H Nyomatékkulcs

RO Cheie cu dinamometru
 F Clé dynamométrique
 I Chiave dinamometrica

E Llave dinamoétrica
 CN 传统型可调式扭力扳手

1/4" 6.3mm TOLERANCE TOLERANȚA CW +-3% CCW +-3% CrMo42 CrMo30



YATO	Ø	Nm	L (mm)	
YT-07720	1/4" (6.3 mm)	1-5	230-236	5
YT-07721	1/4" (6.3 mm)	2-10	240-246	10
YT-07722	1/4" (6.3 mm)	2.5-12	265-288	5
YT-07723	1/4" (6.3 mm)	4-20	268-288	5

BMC

GB Torque wrench
 D Drehmomentschlüssel
 PL Klucz dynamometryczny

RUS Ключ динамометрический
 CZ Dynamometrický klíč
 H Nyomatékkulcs

RO Cheie cu dinamometru
 F Clé dynamométrique
 I Chiave dinamometrica

E Llave dinamoétrica
 CN 传统型可调式扭力扳手

3/8" 10mm TOLERANCE TOLERANȚA CW +-3% CCW +-3% CrMo42 CrMo30



YATO	Ø	Nm	L (mm)	
YT-07730	3/8" (9.5 mm)	6-30	295-316	10
YT-07731	3/8" (9.5 mm)	10-60	362-385	20
YT-07732	3/8" (9.5 mm)	20-100	420-440	10
YT-07733	3/8" (9.5 mm)	25-125	415-440	3

BMC

Torque wrenches & torque multipliers Klucze dynamometryczne i wzmacniacze momentu



GB Torque wrench
D Drehmomentschlüssel
PL Klucz dynamometryczny

RUS Ключ динамометрический
CZ Dynamometrický klíč
H Nyomatékkulcs

RO Cheie cu dinamometru
F Clé dynamométrique
I Chiave dinamometrica

E Llave dinamométrica
CN 传统型可调式扭力扳手

1/2" 12.5mm
TOLERANCE / TOLERANȚA
CW +3% CCW +3%
CrMo42
CrMo30



YATO	Ø	Nm	L (mm)	Box
YT-07740	1/2" (12.7 mm)	10-60	360-385	8
YT-07741	1/2" (12.7 mm)	20-100	420-440	15
YT-07742	1/2" (12.7 mm)	25-125	415-440	5
YT-07743	1/2" (12.7 mm)	40-200	445-465	12
YT-07744	1/2" (12.7 mm)	65-335	505-525	15



GB Torque wrench
D Drehmomentschlüssel
PL Klucz dynamometryczny

RUS Ключ динамометрический
CZ Dynamometrický klíč
H Nyomatékkulcs

RO Cheie cu dinamometru
F Clé dynamométrique
I Chiave dinamometrica

E Llave dinamométrica
CN 传统型可调式扭力扳手

3/4" 19mm
TOLERANCE / TOLERANȚA
CW +3% CCW +3%
CrMo42
CrMo30



YATO	Ø	Nm	L (mm)	Box
YT-07750	3/4" (19.0 mm)	80-400	685-704	5
YT-07751	3/4" (19.0 mm)	100-500	825-845	5



GB Torque wrench
D Drehmomentschlüssel
PL Klucz dynamometryczny

RUS Ключ динамометрический
CZ Dynamometrický klíč
H Nyomatékkulcs

RO Cheie cu dinamometru
F Clé dynamométrique
I Chiave dinamometrica

E Llave dinamométrica
CN 传统型可调式扭力扳手

3/4" 19mm
TOLERANCE / TOLERANȚA
≤ 500 Nm CW +3% CCW +3%
> 500 Nm CW +4% CCW +4%
CrMo42
CrMo30



YATO	Ø	Nm	L (mm)	Box
YT-07752	3/4" (19.0 mm)	160-800	1030-1050	2
YT-07753	3/4" (19.0 mm)	200-1000	1030-1050	2



GB Torque wrench
D Drehmomentschlüssel
PL Klucz dynamometryczny

RUS Ключ динамометрический
CZ Dynamometrický klíč
H Nyomatékkulcs

RO Cheie cu dinamometru
F Clé dynamométrique
I Chiave dinamometrica

E Llave dinamométrica
CN 传统型可调式扭力扳手

1" 25mm
TOLERANCE / TOLERANȚA
≤ 500 Nm CW +3% CCW +3%
> 500 Nm CW +4% CCW +4%
CrMo42
CrMo30



YATO	Ø	Nm	L (mm)	Box
YT-07760	1" (25.4 mm)	80-400	1030-1050	5
YT-07761	1" (25.4 mm)	100-500	1030-1050	5



GB Torque wrench
D Drehmomentschlüssel
PL Klucz dynamometryczny

RUS Ключ динамометрический
CZ Dynamometrický klíč
H Nyomatékkulcs

RO Cheie cu dinamometru
F Clé dynamométrique
I Chiave dinamometrica

E Llave dinamométrica
CN 传统型可调式扭力扳手

1" 25mm
TOLERANCE / TOLERANȚA
≤ 500 Nm CW +3% CCW +3%
> 500 Nm CW +4% CCW +4%
CrMo42
CrMo30



YATO	Ø	Nm	L (mm)	Box
YT-07762	1" (25.4 mm)	300-1500	2160-2190	1



GB Torque wrench
D Drehmomentschlüssel
PL Klucz dynamometryczny

RUS Ключ динамометрический
CZ Dynamometrický klíč
H Nyomatékkulcs

RO Cheie cu dinamometru
F Clé dynamométrique
I Chiave dinamometrica

E Llave dinamométrica
CN 传统型可调式扭力扳手

3/4" 19mm 1/2" 12.5mm
CrV 6140



YATO	Ø	Nm	L (mm)	Box
YT-0761	1/2" (12.7 mm)	40-210	516-534	10
YT-0770	3/4" (19.0 mm)	100-500	845-860	4
YT-0771	3/4" (19.0 mm)	140-980	1215-1230	2



GB Torque wrench
D Drehmomentschlüssel
PL Klucz dynamometryczny

RUS Ключ динамометрический
CZ Dynamometrický klíč
H Nyomatékkulcs

RO Cheie cu dinamometru
F Clé dynamométrique
I Chiave dinamometrica

E Llave dinamométrica
CN 传统型可调式扭力扳手

3/4" 19mm 1/2" 12.5mm
CrV 6140



YATO	Ø	Nm	L (mm)	Box
YT-0754	1/2" (12.7 mm)	60-340	592-613	10
YT-0755	3/4" (19.0 mm)	200-1000	1220-1245	2



GB Torque wrench
D Drehmomentschlüssel
PL Klucz dynamometryczny

RUS Ключ динамометрический
CZ Dynamometrický klíč
H Nyomatékkulcs

RO Cheie cu dinamometru
F Clé dynamométrique
I Chiave dinamometrica

E Llave dinamométrica
CN 传统型可调式扭力扳手

3/4" 19mm
TOLERANCE / TOLERANȚA
CW +3% CCW +3%
HRC 48-52
CrV 6140



YATO	Ø	Nm	L (mm)	Box
YT-07711	3/4" (19.0 mm)	150-800	1155-1175	2

BMC & COLOR SLEEVE



GB Dial torque wrench
D Drehmomentschlüssel mit Skalenmessuhr
PL Zegarowy klucz dynamometryczny
RUS Стрелочный динамометрический ключ
CZ Momentový klíč s kruhovou stupnicí
H Mérőtárcsás nyomatékkulcs

RO Cheie dinamometrica cu ceas
F Clé dynamométrique avec horloge
I Chiave dinamometrica a orologio
E Llave dinamométrica con reloj
CN 扭力扳手

1/4" 3/8"
6.3mm 10mm
1/2" 12.5mm
TOLERANCE TOLERANȚA +/- 3%

GB Dial torque wrench
D Drehmomentschlüssel mit Skalenmessuhr
PL Zegarowy klucz dynamometryczny
RUS Стрелочный динамометрический ключ
CZ Momentový klíč s kruhovou stupnicí
H Mérőtárcsás nyomatékkulcs

RO Cheie dinamometrica cu ceas
F Clé dynamométrique avec horloge
I Chiave dinamometrica a orologio
E Llave dinamométrica con reloj
CN 扭力扳手

1/2" 12.5mm
TOLERANCE TOLERANȚA +/- 3%



YATO	Ø	Nm	L (mm)	
YT-07830	1/4" (6.3 mm)	0.5-5	335	5
YT-07831	1/4" (6.3 mm)	1-10	335	5
YT-07832	3/8" (9.5 mm)	3-30	335	5
YT-07833	3/8" (9.5 mm)	5-50	335	4
YT-07834	1/2" (12.7 mm)	10-100	390	6

YATO	Ø	Nm	L (mm)	
YT-07835	1/2" (12.7 mm)	20-200	490	5
YT-07836	1/2" (12.7 mm)	30-300	590	5

GB Interchangeable torque handle
D Handgriff eines dynamometrischen Schlüssels
PL Rękojeść klucza dynamometrycznego
RUS Рукоятка динамометрического ключа
CZ Rukojeť dynamometrického klíče
H Nyomatékkulcs nyél

RO Mâner pt. cheie dinamometrică
F Clé dynamométrique sans embouts
I Maniglia per chiave dinamometrica
E Mango de llave dinamométrica
CN 扭力扳手



9x12mm 14x18mm CrMo 30 TOLERANCE TOLERANȚA +/- 3%



YATO	Ø	Nm	L (mm)	
YT-07850	9x12	2.5-12	260-282	5
YT-07851	9x12	4-20	262-280	5
YT-07852	9x12	6-30	280-300	3
YT-07853	9x12	10-60	345-370	5
YT-07854	9x12	20-100	405-425	5
YT-07855	9x12	25-125	400-425	3
YT-07856	14x18	40-200	438-458	5
YT-07857	14x18	65-335	495-518	5
YT-07858	14x18	80-400	675-698	5

GB Removable head for torque wrench
D Umschaltknarrenkopf
PL Głowica do klucza dynamometrycznego
RUS Треугольная головка для динамометрического ключа
CZ Výměnná rączna k momentovému klíči
H Külső cserélhető irányváltós racsnis
RO Cap cheie inelara interschimbabil pt. cheie dinamometrică
F Tête pour une clé dynamométrique
I Attacchi quadrati di manovra
E Cabeza de anillo intercambiable para llave dinamométrica
CN 扭力扳手插件

1/4" 3/8" 1/2" 3/4"
6.3mm 10mm 12.5mm 19mm
9x12mm 14x18mm RATCHET SYSTEM ZAPADKOWY CrMo 42



YATO	Ø	Ø	
YT-07870	1/4" (6.3 mm)	9x12	10
YT-07871	3/8" (9.5 mm)	9x12	10
YT-07872	1/2" (12.7 mm)	9x12	10
YT-07873	1/2" (12.7 mm)	14x18	10
YT-07874	3/4" (19.0 mm)	14x18	5

GB Torque angle gauge
D Winkelmesser zum Anziehen von Schrauben
PL Kałomierz do dokręcania śrub
RUS Угломер для подвёртывания болтов
CZ Úhloměr k utahování šroubů
H Nyomaték szögmérő
RO Raportor pt. inşurubat şuruburi
F Rapporteur à serrer les vis
I Goniometro per il serraggio controllo
E Calibrador para apretar tornillos
CN 扭力角度规

1/2" 12.5mm 360° CrV



YATO		
YT-0593		12/48

GB Torque multiplier
D Drehmomentverstärker
PL Mechaniczny wzmacniacz momentu
RUS Мультипликатор крутящего момента

CZ Mechanicky posilovac momentu
H Nyomaték sokszorozó
RO Antrenor cu amplificator de forta
F Amplificateur de couple mécanique

I Moltiplicatore di coppia
E Mecanismo de reforzar el momento
CN 3倍扭力倍增器

3/4" max. 900 Nm 1" max. 2700 Nm 3:1 CrMo 4140

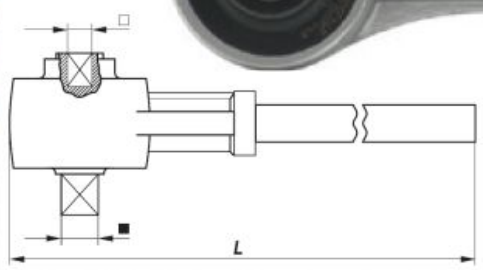

YATO	F	Tmax. (Nm)	M	Tmax. (Nm)	L (mm)	
YT-0781	3/4" (19.0 mm)	900	1" (25.4 mm)	2700	500	2

Torque wrenches & torque multipliers Klucze dynamometryczne i wzmacniacze momentu

GB Labor save wrench
D Drehmomentverstärker
PL Mechaniczny wzmacniacz momentu
RUS Механический усилитель силы
CZ Mechanický posilovač momentu
H Nyomaték sokszorozó
RO Antrenor cu amplificator de forta
F Amplificateur de couple mécanique
I Moltiplicatore di coppia
E Mecanismo de reforzar el momento
CN 扭力倍增器



BMC
& COLOR SLEEVE



YATO	Ø	Nm	L (mm)	☐
YT-0782	1" (25.4 mm)	4200	330	1

GB Labor save wrench
D Drehmomentverstärker
PL Mechaniczny wzmacniacz momentu
RUS Механический усилитель силы
CZ Mechanický posilovač momentu
H Nyomaték sokszorozó
RO Antrenor cu amplificator de forta
F Amplificateur de couple mécanique
I Moltiplicatore di coppia
E Mecanismo de reforzar el momento
CN 扭力倍增器



BMC
& COLOR SLEEVE



YATO	Ø	Nm	L (mm)	☐
YT-07822	1" (25.4 mm)	5800	380	1

Memo

5

Screwdrivers & screwdriver bits Wkrętaki i końcówki wkrętakowe



Screwdrivers, 3 color handle
Wkrętaki, trój kolorowa rączka

72-74



Slotted screwdrivers Wkrętaki płaskie.....	72
Phillips screwdrivers Wkrętaki krzyżakowe.....	72
Pozidrive screwdrivers Wkrętaki „Pozidrive”.....	72
Torx screwdrivers Wkrętaki „Torx”.....	72
Torx Security screwdrivers Wkrętaki „Torx Security”.....	72
Go-through screwdrivers Wkrętaki do pobijania.....	72
Screwdriver sets Komplety wkrętaków.....	73

Screwdrivers, 3 color handle
Wkrętaki, trój kolorowa rączka

75-76



Slotted screwdrivers Wkrętaki płaskie.....	75
Phillips screwdrivers Wkrętaki krzyżakowe.....	75
Pozidrive screwdrivers Wkrętaki „Pozidrive”.....	75
Torx screwdrivers Wkrętaki „Torx”.....	75
Torx Security screwdrivers Wkrętaki „Torx Security”.....	75
Screwdriver sets Komplety wkrętaków.....	75

Precision screwdrivers, 3 color handle
Wkrętaki precyzyjne, trój kolorowa rączka

76



Precision slotted screwdrivers Wkrętaki precyzyjne płaskie.....	76
Precision phillips screwdrivers Wkrętaki precyzyjne krzyżakowe.....	76
Precision Torx screwdrivers Wkrętaki precyzyjne „Torx”.....	76
Precision screwdriver sets Zestawy wkrętaków precyzyjnych.....	76

Insulated screwdrivers
Wkrętaki izolowane

77



Insulated slotted screwdrivers Wkrętaki izolowane płaskie.....	77
Insulated phillips screwdrivers Wkrętaki izolowane krzyżakowe.....	77
Insulated Pozidrive screwdrivers Wkrętaki izolowane „Pozidrive”.....	77
Insulated screwdriver sets Komplety wkrętaków izolowanych.....	77

Special screwdrivers & impact screwdrivers
Wkrętaki specjalne i udarowe

78-79



Ratchet screwdriver sets Wkrętaki z grzechotką.....	78
Impact screwdrivers Wkrętaki udarowe.....	79

Screwdriver bits
Końcówki wkrętakowe

79-85

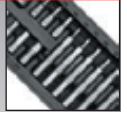

Phillips screwdriver bits Końcówki wkrętakowe krzyżakowe.....	79
Torx screwdriver bits Końcówki wkrętakowe „Torx”.....	79
YATO NON-SLIP SYSTEM screwdriver bits Końcówki wkrętakowe „YATO NON-SLIP SYSTEM”.....	79
Screwdriver bit sets Zestawy końcówek wkrętakowych.....	80

Nut setters

Nasadki magnetyczne do wkrętarek

86



Screwdriver bit holders

Uchwyty do końcówek wkrętakowych

86-87



Hex & Torx keys & sets

Klucze imbusowe i zestawy

87-91



Insulated hex keys Klucze imbusowe izolowane.....	87
Hex keys with handle Klucze imbusowe z rękojeścią.....	87
T-handle keys & sets Klucze imbusowe typu „T” i zestawy.....	88
Hex keys & sets Klucze imbusowe i zestawy.....	89
Torx & Torx Security keys & sets Klucze „Torx”, „Torx Security” i zestawy.....	91
Plastic covered hex & Torx Security keys Klucze imbusowe powlekane.....	91

GB Screwdriver
D Schraubendreher
PL Wkrętek
RUS Отвёртка
CZ Šroubovák
H Csavarhúzó

RO Şurubelniţă
F Tournevis
I Cacciavite
E Destornillador
CN 螺丝刀

PLASTIC HANGER



COLOR BOX



PCS packing



S2

HRC 58



YATO	Tip	L (mm)	PCS packing	Box
YT-25900	2	75	12	96/384
YT-25901	3	75	12	96/384
YT-25902	3	100	12	96/384
YT-25903	3	150	12	60/240
YT-25904	4	100	12	96/384
YT-25905	4	150	12	96/384
YT-25906	4	200	12	96/384
YT-25907	5	75	12	60/240
YT-25908	5	100	12	60/240
YT-25909	5	150	12	60/240
YT-25910	6	38	12	60/240
YT-25911	6	100	12	36/144
YT-25912	6	150	12	36/144
YT-25913	6	200	12	36/144
YT-25914	8	150	6	24/96



YATO	Tip	L (mm)	PCS packing	Box
YT-25920	PH0	75	12	96/384
YT-25921	PH0	100	12	96/384
YT-25922	PH1	38	12	60/240
YT-25923	PH1	75	12	60/240
YT-25924	PH1	100	12	60/240
YT-25925	PH1	150	12	60/240
YT-25926	PH1	200	12	36/144
YT-25927	PH1	300	6	24/96
YT-25928	PH2	38	12	60/240
YT-25929	PH2	100	12	36/144
YT-25930	PH2	150	12	36/144
YT-25931	PH2	200	12	36/144
YT-25932	PH2	300	6	24/96
YT-25933	PH3	150	6	24/96
YT-25934	PH3	200	6	24/96



YATO	Tip	L (mm)	PCS packing	Box
YT-25940	PZ1	75	12	60/240
YT-25941	PZ1	100	12	60/240
YT-25942	PZ2	100	12	36/144
YT-25943	PZ2	150	12	36/144



YATO	Tip	L (mm)	PCS packing	Box
YT-25950	T5	75	12	96/384
YT-25951	T6	75	12	96/384



YATO	Tip	L (mm)	PCS packing	Box
YT-25952	T7	75	12	96/384
YT-25953	T8	75	12	96/384
YT-25954	T9	75	12	96/384
YT-25955	T10	100	12	60/240
YT-25956	T15	100	12	60/240
YT-25957	T20	100	12	60/240
YT-25958	T25	100	12	36/144
YT-25959	T27	100	12	36/144
YT-25960	T30	100	12	36/144
YT-25961	T40	100	6	24/96



GB Go-through screwdriver
D Schlagschrauber
PL Wkrętek do pobijania
RUS Отвёртка-било
CZ Šroubovák s úderným koncem

H Beütő csavarhúzó
RO Şurubelniţă pt. fixare
F Tournevis à frapper
I Cacciavite per viti con intaglio

E Destornillador para dar golpes
CN 敲击螺丝批

PLASTIC HANGER



COLOR BOX



6 PCS



CrV 6150

HRC 52



YATO	Tip	L (mm)	PCS packing	Box
YT-25985	6	100	6	24/96
YT-25986	6	150	6	24/96
YT-25987	6	200	6	24/96
YT-25988	6	250	6	24/96
YT-25989	8	150	6	24/72
YT-25990	8	200	6	24/72
YT-25991	8	250	6	24/72
YT-25992	8	300	6	24/72



YATO	Tip	L (mm)	PCS packing	Box
YT-25993	PH2	100	6	24/96
YT-25994	PH2	150	6	24/96
YT-25995	PH3	150	6	24/72
YT-25996	PH3	200	6	24/72
YT-25997	PH3	250	6	24/72



- GB Screwdriver set
D Schraubendrehersatz
PL Komplet wkrętaków
RUS Набор отвёрток
- CZ Zámečnické šroubováky
H Lakatos csavarhózó
RO Şurubelnițe de lăcătuşerie
F Set de tournevis
- I Set cacciaviti
E Juego de destornilladores
CN 螺丝批组套



DOUBLE BLISTER

YATO	⊖	⊕	L (mm)	
YT-25998	6	PH2	150 150	6/36

- GB Screwdriver set
D Schraubendrehersatz
PL Komplet wkrętaków
RUS Набор отвёрток
CZ Zámečnické šroubováky
H Lakatos csavarhózó
- RO Şurubelnițe de lăcătuşerie
F Set de tournevis
I Set cacciaviti
E Juego de destornilladores
CN 螺丝批组套

DOUBLE BLISTER



6
PCS



8
PCS



YATO	⊖	⊕	L (mm)	
YT-25965	3.0		75	6/24
	5.0		100	
	6.0		100	
		PH0	75	
		PH1	100	
		PH2	100	

YATO	⊖	⊕	L (mm)	
YT-25980	2.0		50	6/24
	2.4		50	
	6.0		38	
	6.0		100	
		PH0	50	
		PH1	50	
		PH2	38	
		PH2	100	



8
PCS



12
PCS



YATO	⊖	⊕	L (mm)	
YT-25966	5.0		100	6/12
	6.0		100	
	8.0		150	
		PH0	75	
		PH1	100	
		PH2	38	
		PH2	100	
		PH3	150	

YATO	⊖	⊕	□	L (mm)	
YT-25967	3.0			75	6/12
	5.0			75	
	6.0			38	
	6.0			150	
	6.0			150	
	8.0			150	
		PH0		75	
		PH1		75	
		PH2		38	
		PH2		100	
		PH2		150	
			SQ1	100	
		SQ2	100		

GB Screwdriver set
 D Schraubendrehersatz
 PL Komplet wkrętek
 RUS Набор отвёрток
 CZ Zámečnické šroubováky
 H Lakatos csavarhózó

RO Şurubelnițe de lăcătușerie
 F Set de tournevis
 I Set cacciaviti
 E Juego de destornilladores
 CN 螺丝批组套

15 PCS

⊖ ⊕

⊛ ⊣

S2

HRC 58



YATO	⊖	⊕	⊛	L (mm)		
YT-25981	1.5			50	6/24	
	2.0			50		
	5.0			75		
	6.0			38		
	6.0			100		
	6.0			125		
			PH00	50		
			PH0	50		
			PH1	75		
			PH2	38		
			PH2	100		
				T5		50
				T6		50
				T7		50
			T8	50		

GB 6 in 1 interchangeable screwdriver set
 D Umsteckschraubendreher
 PL Wkrętak z końcówkami dwustronnymi
 RUS Отвёртка с двухсторонними насадками
 CZ Šroubovák lancer z dvoustrannou koncovkou
 H Csavarhúzó kétvégű szárral
 RO Şurubelniță cu dublu capăt
 F Tournevis embouts réversibles
 I Cacciavite reversibile
 E Destornillador con punta de dos caras
 CN 6合1螺丝批组套

5.0 mm PH1

6.0 mm PH2

1/4" (6.3 mm)

5/16" (8 mm)

MAGNETIC TIP

S2



YATO	
YT-25971	12/96

GB Mini pick & hook set
 D Mini hacken set
 PL Zestaw haczyków z rękojeścią
 RUS Набор ключков с рукоятками
 CZ Sada háčkových mini páčidel
 H Mini ár és kampó készlet

RO Mini-set pt. extras garnituri
 F Set de crochets
 I Set ganci con maniglia
 E Juego de palancas de hierro
 CN 迷你拉拔器组套

4 PCS



HRC 40



SLIDING CARD



YATO	
YT-0843	12/72

GB Screwdriver set
 D Schraubendrehersatz
 PL Komplet wkrętek

RUS Набор отвёрток
 CZ Zámečnické šroubováky
 H Lakatos csavarhózó

RO Şurubelnițe de lăcătușerie
 F Set de tournevis
 I Set cacciaviti

E Juego de destornilladores
 CN 螺丝批组套

⊖ ⊕

S2

HRC 58

9 PCS

⊖ ⊕



YATO	⊖	⊕	L (mm)		
YT-25968	3.0		75	6/12	
	5.0		75		
	6.0		100		
	6.0		150		
	6.0		150		
	8.0		150		
			PH0		75
			PH1		75
			PH2		100
			PH2		150

18 PCS

⊖ ⊕

⊛ ⊣



PLASTIC HANGER & DOUBLE BLISTER



YATO	⊖	⊕	⊛	L (mm)		
YT-25982	2.4			50	6/12	
	3.0			50		
	5.0			75		
	6.0			38		
	6.0			100		
	8.0			150		
			PH00	50		
			PH0	50		
			PH1	75		
			PH2	38		
			PH2	100		
			PH3	150		
				T5		50
				T6		50
			T7	50		
			T8	50		
			T9	50		
			T10	50		

GB Screwdriver
D Schraubendreher
PL Wkrętak
RUS Отвёртка
CZ Šroubovák
H Csavarhúzó

RO Şurubelniţă
F Tournevis
I Cacciavite
E Destornillador
CN 螺丝刀

- application: industry
- can be used as go-through
- special highest quality alloy steel
- przeznaczenie: przemysł
- możliwość pobijania
- stal wysokostopowa

COLOR BOX



SVC55



HRC 58-62

YATO	⊖	L (mm)	PCS packing	
YT-2601	3.0	75	12	240
YT-2606	4.0	100	12	240
YT-2608	5.5	100	12	240
YT-2609	5.5	150	12	240
YT-2610	5.5	200	12	240
YT-2612	6.5	38	12	240
YT-2613	6.5	100	12	240
YT-2614	6.5	150	12	240
YT-2615	6.5	200	12	240

HRC 55-59

YATO	⊖	L (mm)	PCS packing	
YT-2618	8.0	150	6	120
YT-2602	3.0	100	12	240
YT-2633	3.0	300	12	240
YT-2634	4.0	400	12	240
YT-2635	5.0	300	12	120
YT-2636	5.0	400	12	120



HRC 58-62

YATO	⊕	L (mm)	PCS packing	
YT-2640	PH0	75	12	240
YT-2642	PH1	75	12	240
YT-2643	PH1	100	12	240
YT-2644	PH1	150	12	240
YT-2645	PH1	200	12	240
YT-2647	PH2	38	12	240
YT-2648	PH2	100	12	240
YT-2649	PH2	150	12	240
YT-2650	PH2	200	12	240

HRC 55-59

YATO	⊕	L (mm)	PCS packing	
YT-2641	PH1	38	12	240



HRC 58-62

YATO	⊕	L (mm)	PCS packing	
YT-2661	PZ0	75	12	240
YT-2663	PZ1	100	12	240
YT-2665	PZ2	150	12	240
YT-2667	PZ3	150	6	240

HRC 55-59

YATO	⊕	L (mm)	PCS packing	
YT-2657	PZ1	400	12	120
YT-2655	PZ2	38	12	240
YT-2658	PZ2	400	12	120



HRC 58-62

YATO	⊗	L (mm)	PCS packing	
YT-2741	T5	75	12	240
YT-2742	T6	75	12	240

HRC 58-62

YATO	⊗	L (mm)	PCS packing	
YT-2743	T7	75	12	240
YT-2744	T8	75	12	240
YT-2745	T9	75	12	240
YT-2746	T10	100	12	240
YT-2748	T15	100	12	240
YT-2750	T20	100	12	240
YT-2752	T25	100	12	240
YT-2753	T27	100	12	240
YT-2754	T30	100	12	240
YT-2756	T40	100	12	240

GB Screwdriver set
D Schraubendrehersatz
PL Komplet wkrętaków

RUS Набор отвёрток
CZ Zámečnické šroubováky
H Lakatos csavarhózó

RO Şurubelniţe de lăcătuşerie
F Set de tournevis
I Set cacciaviti

E Juego de destornilladores
CN 螺丝批组套

6 PCS

⊖

⊕



SVC55

HRC 58-62



DOUBLE BLISTER



YATO	⊖	⊕	L (mm)	
YT-2668	5.5		100	6/24
	6.5		100	
	8.0		150	
		PH1	100	
		PH2	100	
		PH3	150	

GB Screwdriver set
 D Schraubendrehersatz
 PL Komplet wkręteków

RUS Набор отвёрток
 CZ Zámečnické šroubováky
 H Lakatos csavarhúzó

RO Șurubelnițe de lăcătușerie
 F Set de tournevis
 I Set cacciaviti

E Juego de destornilladores
 CN 螺丝批组套

8 PCS ⊖ ⊕  SVC55 HRC 58-62



DOUBLE BLISTER

YATO	⊖	⊕	L (mm)	
YT-2670	4.0		100	4/16
	5.5		100	
	6.5		38	
	6.5		100	
		PH0	75	
		PH1	100	
		PH2	38	
		PH2	100	

GB Precision screwdriver
 D Präzisions-Schraubendreher
 PL Wkrętak precyzyjny
 RUS Отвёртка для точных работ

CZ Šroubovák pro jemnou mechaniku
 H Műszerész csavarhúzó
 RO Șurubelniță mecanică fină
 F Tournevis de précision

I Cacciavite di precisione
 E Destornillador de precisión
 CN 螺丝批

S2 HRC 57-61



YATO	⊖	L (mm)	
YT-25802	1.4	50	50/400
YT-25803	1.6	50	50/400
YT-25804	1.8	50	50/400
YT-25805	2.0	50	50/400
YT-25806	2.0	75	50/400
YT-25807	2.4	50	50/400
YT-25808	2.4	75	50/400
YT-25809	3.0	50	50/400
YT-25810	3.0	75	50/400
YT-25811	3.0	100	50/400

YATO	⊕	L (mm)	
YT-25831	PH000	50	50/400
YT-25832	PH000	75	50/400
YT-25833	PH00	50	50/400
YT-25834	PH00	75	50/400
YT-25835	PH0	50	50/400
YT-25836	PH0	75	50/400
YT-25837	PH0	100	50/400
YT-25838	PH1	50	50/400
YT-25839	PH1	100	50/400
YT-25840	PH1	150	50/400

YATO		L (mm)	
YT-25852	T5	50	50/400
YT-25853	T6	50	50/400
YT-25854	T7	50	50/400
YT-25855	T8	50	50/400
YT-25856	T9	50	50/400
YT-25857	T10	50	50/400

GB Precision screwdriver set
 D Präzisions-Feinmechanikersatz
 PL Zestaw wkręteków precyzyjnych
 RUS Набор прецизионных отвёрток

CZ Šroubováky sada pro jemnou mechaniku
 H Órás csavarhúzó készlet
 RO Set șurubelnițe

F Set de tournevis de précision
 I Set cacciavite di precisione
 E Destornilladores precisos
 CN 螺丝批组套

PLASTIC BOX & DOUBLE BLISTER

S2 HRC 57-61



6 PCS



6 PCS



7 PCS



YATO	⊖	⊕	L (mm)	
YT-25861	1.4		50	6/36
	2.0		50	
	2.4		50	
		PH00	50	
		PH0	50	
		PH1	50	

YATO		L (mm)	
YT-25862	T5	50	6/36
	T6	50	
	T7	50	
	T8	50	
	T9	50	
	T10	50	

YATO	⊖	⊕		L (mm)		
YT-25863	2.0			50	6/36	
	3.0			50		
			PH00	50		
			PH0	50		
				T5		50
				T6		50
				T7		50
						50

GB Insulated screwdriver
D Isolierte Schraubendreher
PL Wkrętak izolowany
RUS Изолированная отвёртка
CZ Izolovaný šroubovák
H Szigetelt csavarhúzó

RO Șurubelniță izolată
F Tournevis isolé
I Cacciavite isolato
E Destornillador aislado
CN 绝缘螺丝批



PLASTIC
HANGER

- application: industry
- VDE certificate
- przeznaczenie: przemysł
- certifikat VDE



YATO	⊖	L (mm)	📦
YT-2815	3.0	75	12/120
YT-2816	4.0	75	12/120
YT-2817	4.0	100	12/120
YT-2818	5.5	125	12/120
YT-2819	6.5	150	12/120
YT-2820	8.0	175	12/120



YATO	⊕	L (mm)	📦
YT-2821	PH0	60	12/120
YT-2822	PH1	80	12/120
YT-2823	PH2	100	12/120
YT-2824	PH3	150	12/120



YATO	⊕	L (mm)	📦
YT-2825	PZ1	80	12/120
YT-2826	PZ2	100	12/120

GB Insulated screwdriver set
D Isolierte Schraubendreher
PL Komplet wkrętaków izolowanych
RUS Изолированная отвёртка - набор

CZ Izolované šroubováky
H Szigetelt csavarhúzó
RO Șurubelniță izolată
F Set de tournevis isolés

I Set di cacciavite isolato
E Juego de destornilladores aislado
CN 绝缘螺丝批组套

- application: industry
- VDE certificate
- przeznaczenie: przemysł
- certifikat VDE

DOUBLE
BLISTER



5
PCS



7
PCS



YATO	⊖	⊕	L (mm)	📦
YT-2827	3.0		100	10/40
	4.0		100	
	5.5		125	
		PH1	80	
		PH2	100	

YATO	⊖	⊕	⊕	L (mm)	📦
YT-2828	3.0			100	10/40
	4.0			100	
	5.5			125	
		PH1		80	
		PH2		100	
			PZ1	80	
			PZ2	100	
				100	

GB Insulated changeable screwdriver set
D Schraubendreher Satz isoliert
PL Zestaw wkrętak z wymiennymi końcówkami izolowanymi

RUS Набор изолированных отверток
CZ Sada izolovaného nářadí
H Csavarhúzó kétvégű szárral
RO Set șurubelniță cu biti, izolate

F Jeu d'outils isolés
I Set di cacciavite isolato
E Juego de destornilladores aislado
CN 绝缘螺丝批组套

1000V
VDE CERTIFICATE
EN 60900:2012

NYLON CASE
& POLYBAG

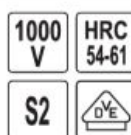

⊖ 2.0, 2.5, 3.0, 3.5, 4.0, 5.5, 6.5 (L=100 mm); S2;
⊕ PH0, PH1, PH2 (L=100 mm); S2;
4x150 mm; 250V

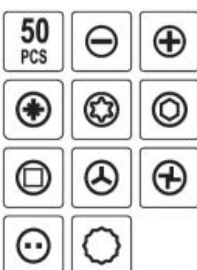

⊖ 2.0, 2.5, 3.0, 3.5, 4.0, 5.5, 6.5 (L=100 mm); S2;
⊕ PH0, PH1, PH2 (L=100 mm); S2;
⊕ PZ0, PZ1, PZ2 (L=100 mm); S2;
⊕ T6, T8, T9, T10, T15, T20, T25, T27, T30 (L=100 mm); S2;
⊕ 2, 3, 4, 5, 6 (L=100 mm); S2;
⊕ R1, R2 (L=100 mm); S2;
⊕ 1, 2, 3, 4 (L=100 mm); S2;
⊕ 4, 6, 8, 10 (L=100 mm); S2;
⊕ 4, 6, 8, 10 (L=100 mm); S2;
⊕ M4, M5, M6 (L=100 mm); S2;
4x150 mm; 250V

12
PCS



YATO	📦
YT-28290	24

YATO	📦
YT-28293	10

- GB** 22 in 1 interchangeable screwdriver set
D Umsteckschraubendreher
PL Wkręta z końcówkami dwustronnymi
RUS Отвёртка - двухсторонние насадки
CZ Šroubovák lances
 z dvoustrannou koncovkou
H Csavarhúzó kétvégű szárral
RO Şurubelniţă cu dublu capăt
F Tournevis
 + embouts 22 en 1
I Set cacciavite con punte reversibile
E Destornillador con punta dos caras
CN 22合一螺丝批组套

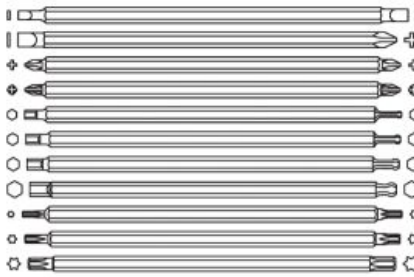

- DOUBLE BLISTER**
- 4 mm x 5 mm (L=175/115 mm);
 6.5 mm x PH3 (L=175/115 mm);
 PH1 x PH2 (L=175/115 mm);
 PZ1 x PZ2 (L=175/115 mm);
 3 mm x 3 mm (L=175/115 mm);
 4 mm x 4 mm (L=175/115 mm);
 5 mm x 5 mm (L=175/115 mm);
 6 mm x 6 mm (L=175/115 mm);
 T10 x T15 (L=175/115 mm);
 T20 x T25 (L=175/115 mm);
 T30 x T40 (L=175/115 mm)



YATO
 YT-2797 6/12

5

- GB** Ratchet screwdriver with bits
D Schraubendreher mit Ratche
PL Wkręta z grzechotką i bitami
RUS Отвёртка с трещеткой
CZ Šroubovák z řehtačkou
H Racsnis csavarbehajtó
RO Antrenor cu clichet + set biti
- F** Coffret tournevis à cliquet réversible porte-embouts
I Set di inserti con chiave a cricchetto
E Juego con destornillador y carraca
CN 长套筒组套

- 11 PCS** **1/4" 6.3 mm**
72T
CrV 6150 **S2**



- 1/4" (6.3 mm): 4, 5, 6 mm; S2;
 1/4" (6.3 mm): PH0, PH1, PH2; S2;
 1/4" (6.3 mm): S1, S2, S3; S2;
- DOUBLE BLISTER**
- YATO**
 YT-14390 1/4" (6.3 mm) 25/50

- GB** Ratchet screwdriver set
D Ratschenschraubendreher-set mit einsätzen
PL Wkręta z grzechotką, nasadkami i bitami
RUS Набор головок с трещеткой
CZ Ráčnový kloubový šroubovák s příslušenstvím
H Dugókulcs és bit készlet csukló
- RO** Set surubelnita
F Clé mixte à cliquet + embouts + douilles
I Set cacciavite a cricchetto con prese punta
E Juego con destornillador y carraca
CN 棘轮螺丝批组套

- 30 PCS** **1/4" 6.3 mm**
CrV 6150 **S2**



- 1/4" (6.3 mm): 3.5, 4.0, 5.5, 6.5 mm (L=25 mm);
 1/4" (6.3 mm): PH0, PH1, PH2, PH3 (L=25 mm);
 1/4" (6.3 mm): PZ0, PZ1, PZ2, PZ3 (L=25 mm);
 1/4" (6.3 mm): 4.0, 5.0, 6.0 mm (L=25 mm);
 1/4" (6.3 mm): 5, 6(x2), 7(x2), 8, 9(x2), 10(x2), 11, 13 mm; CrV 6150;
 1/4" (6.3 mm) x 1/4" (6.3 mm); (L=30 mm);
 1/4" (6.3 mm); (L=30 mm)
- DOUBLE BLISTER**
- YATO**
 YT-2798 6/36

- GB** Precision screwdriver with bits
D Schraubendreher und bit-satz
PL Wkręta elastyczny z wymiennymi bitami
RUS Отвёртка с прецизионными битами
CZ Šroubovák ráčnový se sadou bitů
H Órás csavarhúzó-bit készlet
RO Surubelnita + set biti
F Tournevis élastique
I Cacciavite flessibile con punte intercambiabili
E Juego de pizas terminales para destornillador + mango
CN 可弯曲批头组套



- 215 mm;
 1/4" (6.3 mm): 3.0, 3.5, 4.0, 5.5, 6.5 mm (L=25 mm);
 1/4" (6.3 mm): PH0, PH1, PH2, PH3 (L=25 mm);
 1/4" (6.3 mm): PZ0, PZ1, PZ2, PZ3 (L=25 mm);
 1/4" (6.3 mm): T10, T15 (L=25 mm);
 1/4" (6.3 mm): 2.0, 3.0, 4.0, 5.0, 6.0 mm (L=25 mm);
 1/4" (6.3 mm): 5.0, 6.0, 7.0, 8.0(x2), 9.0, 10.0, 11.0, 12.0, 13.0 mm

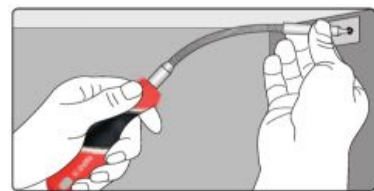

- DOUBLE BLISTER**
- 31 PCS** **1/4" 6.3 mm**
CrV 6150 **S2**
- YATO**
 YT-25972 6/24

- GB** Ratchet screwdriver set
D Ratschenschraubendreher-Satz mit einsätzen
PL Wkręta z grzechotką, przegubem i bitami
RUS Набор головок с трещеткой
CZ Ráčnový kloubový šroubovák s příslušenstvím
H Dugókulcs és bit készlet csukló
- RO** Set surubelnita
F Clé mixte à cliquet + embouts
I Set di chiavi a cricchetto e inserti
E Juego con destornillador y carraca
CN 棘轮螺丝批组套



- 1/4" (6.3 mm): 5, 6, 7, 8, 9, 10, 11, 12, 13 mm;
 1/4" (6.3 mm) x 100 mm;
 1/4" (6.3 mm): CrV 50BV30; H2, H2.5, H3, H4, H5, H6;
 T10, T15, T20, T25, T27, T30, T40; PH1, PH1, PH2, PH2, PH3, PH3;
 3, 4, 5, 6, 7 mm; PZ1, PZ1, PZ2, PZ2, PZ3, PZ3

- 42 PCS** **1/4" 6.3 mm**
CrV 50BV30
- DOUBLE BLISTER**
- YATO**
 YT-2806 12

GB Impact screwdriver
D Schlagschrauber
PL Wkrętak udarowy

RUS Отвёртка ударная
CZ Narazový šroubovák kovový
H Csavarbehajtó, ütő üzemmóddal

RO Şurubelniţă metalică cu percutor
F Tournevis à choc
I Cacciavite percussione

E Destornillador de percusión
CN 冲击螺丝批组套

⌀ 1/2" ⌀ 12.5 mm
⌀ 5/16" ⌀ 8.0 mm

7
PCS



CrV
6150

5/16" (7.9 mm) □ □ □ 1/2" (12.7 mm);
□ 7, 8 mm (L=35 mm); 8mm (L=75 mm);
✦ PH2, PH3 (L=35 mm); PH2 (L=75 mm)



METAL CASE
& COLOR BOX

YATO

YT-2801

5/20

7
PCS



CrV
6150

5/16" (7.9 mm) □ □ □ 1/2" (12.7 mm);
□ 8 mm (L=35 mm); 8 mm (L=75 mm);
✦ PH3 (L=35 mm); PH1, PH2, PH3 (L=75 mm)



BMC & COLOR BOX

YATO

YT-2802

20

7
PCS

175
mm



CrV
6150

5/16" (7.9 mm) □ □ □ 1/2" (12.7 mm);
□ 7, 8 mm (L=35 mm); 8mm (L=75 mm);
✦ PH2, PH3 (L=35 mm); PH3 (L=75 mm)

PLASTIC BOX
& COLOR SLEEVE



YATO

YT-28003

8/16

15
PCS

160
mm



CrV
6150

5/16" (7.9 mm) □ □ □ 1/2" (12.7 mm);
□ 4, 5, 6, 8, 9 mm (L=35 mm); S2;
✦ PH1, PH2, PH3, PH4 (L=35 mm); S2;
□ 4, 5, 6, 8 (L=35 mm); S2

METAL CASE
& COLOR BOX



YATO

YT-28015

16

GB Screwdriver bit set
D Schraubendreherbitsatz
PL Zestaw bitów do wkrętek udarowych
RUS Набор бит крестовых
CZ Sada bitů
H Bitkészlet
RO Truse bit
F Embouts à choc
I Set punte cacciavite
E Puntas de destornilladora
CN 冲击批头组套



CrV
6150

SLIDING
CARD



for / dla: YT-2800, YT-2801

YATO	+	-	L (mm)	⌀	PCS packing	
YT-2810	PH2		36	5/16" (7.9 mm)	5	10/100
YT-2811	PH3		36	5/16" (7.9 mm)	5	10/100
YT-2812	PH2	8	36	5/16" (7.9 mm)	4	10/100
	PH3	10				

GB Screwdriver bit
D Schraubendreherbit
PL Końcówka śrubokrętowa
RUS Бит крестовая
CZ Šroubovákova koncovka
H Csavarhúzóvég

RO Capăt pt. şurubelniţă
F Douille tournevis
I Punta del cacciavite
E Punta de destornilladora
CN 旋具头

SLIDING
CARD



GB Screwdriver bit
D Schraubendreherbit
PL Końcówka śrubokrętowa
RUS Бит крестовая
CZ Šroubovákova koncovka
H Csavarhúzóvég

RO Capăt pt. şurubelniţă
F Douille tournevis
I Punta del cacciavite
E Punta de destornilladora
CN 旋具头

BLISTER
CARD



TORX

AISI
S2



YATO	⌀	L (mm)	⌀ (mm)	
YT-0404	T25	30	10	10/100
YT-0405	T25	75	10	10/100
YT-04051	T30	30	10	10/100
YT-04052	T30	75	10	10/100
YT-0406	T40	30	10	10/100
YT-0407	T40	75	10	10/100
YT-0408	T45	30	10	10/100
YT-0409	T45	75	10	10/100



GOLD
FORGED
KUTE
NA ZIMNO

218_{Nm}
max.

AISI
S2

HRC
58-62

YATO	+	L (mm)	⌀	
YT-0485	PH2	100	1/4" (6.3 mm)	25/100
YT-0486	PH2	150	1/4" (6.3 mm)	25/100
YT-0487	PH2	200	1/4" (6.3 mm)	25/100

GB Screwdriver bit
D Schraubendreherbit
PL Końcówka śrubokrętowa
RUS Бит крестовая

CZ Šroubováková koncovka
H Csavarhúzóvég
RO Capăt pt. șurubelniță
F Douille tournevis

I Punta del cacciavite
E Punta de destornilladora
CN 旋具头

PLASTIC BOX

AISI S2 HRC 58-61 COLD FORGED KUTE NA ZIMNO



YATO	+	L (mm)	torque / moment obrotowy max. (Nm)	PCS packing	
YT-04702	PZ1	25	1/4" (6.3 mm) 6.4	10	25/200
YT-04712	PZ2	25	1/4" (6.3 mm) 19.6	10	25/200
YT-04722	PZ3	25	1/4" (6.3 mm) 45.1	10	25/200

YATO	+	L (mm)	torque / moment obrotowy max. (Nm)	PCS packing	
YT-04742	PH1	25	1/4" (6.3 mm) 6.4	10	25/200
YT-04752	PH2	25	1/4" (6.3 mm) 19.6	10	25/200
YT-04762	PH3	25	1/4" (6.3 mm) 45.1	10	25/200



YATO	+	L (mm)	torque / moment obrotowy max. (Nm)	PCS packing	
YT-04772	PH1	50	1/4" (6.3 mm) 6.4	10	25/100
YT-04782	PH2	50	1/4" (6.3 mm) 19.6	10	25/100
YT-04792	PH3	50	1/4" (6.3 mm) 45.1	10	25/100

YATO	+	+	L (mm)	torque / moment obrotowy max. (Nm)	PCS packing	
YT-04812	PH2	PH2	65	1/4" (6.3 mm) 19.6 / 19.6	10	25/100

GB Screwdriver bit set
D Schraubendreherbitsatz
PL Zestaw końcówek śrubokrętowych
RUS Набор битов
CZ Sada bitů

H Bitkészlet
RO Truse bit
F Embouts de vissage șrubokrętowych
I Set punte cacciavite

PLASTIC BOX



10 PCS AISI S2 HRC 58-61 COLD FORGED KUTE NA ZIMNO

5, 6 mm; PH1, PH1, PH2, PH2;
PZ1, PZ1, PZ2, PZ2

5, 6 mm; PH1, PH1, PH2, PH2;
PZ1, PZ1, PZ2, PZ2

YATO	L (mm)		
YT-04822	25	1/4" (6.3 mm)	25/200

YATO	L (mm)		
YT-04832	50	1/4" (6.3 mm)	25/100

GB Screwdriver bit
D Schraubendreherbit
PL Końcówka śrubokrętowa
RUS Бит крестовая
CZ Šroubováková koncovka
H Csavarhúzóvég

RO Capăt pt. șurubelniță
F Douille tournevis
I Punta del cacciavite
E Punta de destornilladora
CN 旋具头

PLASTIC BOX



YATO	+	L (mm)	torque / moment obrotowy max. (Nm)	PCS packing	
YT-78130	PH0	25	1/4" (6.3 mm) 2.1	10	20/100
YT-78131	PH1	25	1/4" (6.3 mm) 7.8	10	20/100
YT-78132	PH2	25	1/4" (6.3 mm) 19.6	10	20/100
YT-78133	PH3	25	1/4" (6.3 mm) 45.6	10	20/100



YATO	+	L (mm)	torque / moment obrotowy max. (Nm)	PCS packing	
YT-78134	PZ1	25	1/4" (6.3 mm) 6.4	10	20/100
YT-78135	PZ2	25	1/4" (6.3 mm) 19.6	10	20/100
YT-78136	PZ3	25	1/4" (6.3 mm) 45.1	10	20/100



YATO	+	L (mm)	torque / moment obrotowy max. (Nm)	PCS packing	
YT-78141	T10	25	1/4" (6.3 mm) 5.9	10	20/100
YT-78142	T15	25	1/4" (6.3 mm) 8.4	10	20/100
YT-78143	T20	25	1/4" (6.3 mm) 14.7	10	20/100
YT-78144	T25	25	1/4" (6.3 mm) 21.6	10	20/100
YT-78145	T27	25	1/4" (6.3 mm) 29.4	10	20/100
YT-78146	T30	25	1/4" (6.3 mm) 45.1	10	20/100
YT-78147	T40	25	1/4" (6.3 mm) 76.5	10	20/100



YATO	+	L (mm)	torque / moment obrotowy max. (Nm)	PCS packing	
YT-78150	PH0	50	1/4" (6.3 mm) 2.1	10	20/100
YT-78151	PH1	50	1/4" (6.3 mm) 6.4	10	20/100
YT-78152	PH2	50	1/4" (6.3 mm) 19.6	10	20/100
YT-78153	PH3	50	1/4" (6.3 mm) 45.1	10	20/100

YATO	+	L (mm)	torque / moment obrotowy max. (Nm)	PCS packing	
YT-78154	PZ1	50	1/4" (6.3 mm) 6.4	10	20/100
YT-78155	PZ2	50	1/4" (6.3 mm) 19.6	10	20/100
YT-78156	PZ3	50	1/4" (6.3 mm) 45.1	10	20/100



YATO	+	+	L (mm)	torque / moment obrotowy max. (Nm)	PCS packing	
YT-78160	PH1	PH1	65	1/4" (6.3 mm) 6.4 / 6.4	10	20/100
YT-78161	PH2	PH2	65	1/4" (6.3 mm) 19.6 / 19.6	10	20/100
YT-78162	PH3	PH3	65	1/4" (6.3 mm) 45.1 / 45.1	10	20/100
YT-78163	PH1	PH2	65	1/4" (6.3 mm) 6.4 / 19.6	10	20/100
YT-78164	PH2	PH3	65	1/4" (6.3 mm) 19.6 / 45.1	10	20/100

YATO	+	+	L (mm)	torque / moment obrotowy max. (Nm)	PCS packing	
YT-78165	PH1	4.5	65	1/4" (6.3 mm) 6.4 / 6.1	10	20/100
YT-78166	PH2	5.5	65	1/4" (6.3 mm) 19.6 / 8.8	10	20/100
YT-78167	PH3	6.5	65	1/4" (6.3 mm) 45.1 / 14.7	10	20/100

GB Screwdriver bit
D Schraubendreherbit
PL Końcówka śrubokrętowa
RUS Бит крестовая
CZ Šroubovaková koncovka
H Csavarhűzővég

RO Capăt pt. șurubelniță
F Douille tournevis
I Punta del cacciavite
E Punta de destornilladora
CN 旋具头



YATO
S2



YATO	⊖	L (mm)	⊘	torque / moment obrotowy max. (Nm)	PCS packing	📦
YT-77891	4	25	1/4" (6.3 mm)	1.6	2	50/500
YT-77892	5	25	1/4" (6.3 mm)	3.6	2	50/500
YT-77893	6	25	1/4" (6.3 mm)	6.5	2	50/500
YT-77894	8	25	1/4" (6.3 mm)	12.9	2	50/500



YATO	⊕	L (mm)	⊘	torque / moment obrotowy max. (Nm)	PCS packing	📦
YT-77870	PH0	25	1/4" (6.3 mm)	1.0	2	50/500
YT-77871	PH1	25	1/4" (6.3 mm)	5.0	2	50/500
YT-77872	PH2	25	1/4" (6.3 mm)	14.0	2	50/500
YT-77873	PH3	25	1/4" (6.3 mm)	32.0	2	50/500



YATO	⊕	L (mm)	⊘	torque / moment obrotowy max. (Nm)	PCS packing	📦
YT-77878	PH1	25	1/4" (6.3 mm)	5.0	3	50/500
	PH2			14.0		
	PH3			32.0		



YATO	⊕	L (mm)	⊘	torque / moment obrotowy max. (Nm)	PCS packing	📦
YT-77880	PZ1	25	1/4" (6.3 mm)	5.0	2	50/500
YT-77881	PZ2	25	1/4" (6.3 mm)	14.0	2	50/500
YT-77882	PZ3	25	1/4" (6.3 mm)	32.0	2	50/500



YATO	⊕	L (mm)	⊘	torque / moment obrotowy max. (Nm)	PCS packing	📦
YT-77900	T8	25	1/4" (6.3 mm)	2.6	2	50/500
YT-77901	T9	25	1/4" (6.3 mm)	3.4	2	50/500
YT-77902	T10	25	1/4" (6.3 mm)	4.5	2	50/500
YT-77903	T15	25	1/4" (6.3 mm)	7.7	2	50/500
YT-77904	T20	25	1/4" (6.3 mm)	12.7	2	50/500
YT-77905	T25	25	1/4" (6.3 mm)	19.0	2	50/500
YT-77906	T27	25	1/4" (6.3 mm)	26.9	2	50/500
YT-77907	T30	25	1/4" (6.3 mm)	37.4	2	50/500
YT-77908	T40	25	1/4" (6.3 mm)	65.1	2	50/500



YATO	⊕	L (mm)	⊘	torque / moment obrotowy max. (Nm)	PCS packing	📦
YT-77920	3	25	1/4" (6.3 mm)	7.6	2	50/500
YT-77921	4	25	1/4" (6.3 mm)	18.0	2	50/500
YT-77922	5	25	1/4" (6.3 mm)	35.0	2	50/500
YT-77923	6	25	1/4" (6.3 mm)	61.0	2	50/500
YT-77924	8	25	1/4" (6.3 mm)	70.0	2	50/500

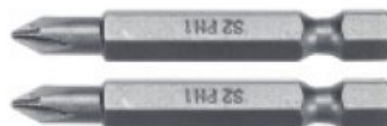

YATO	⊕	L (mm)	⊘	torque / moment obrotowy max. (Nm)	PCS packing	📦
YT-77875	PH1	50	1/4" (6.3 mm)	5.0	2	50/500
YT-77876	PH2	50	1/4" (6.3 mm)	14.0	2	50/500
YT-77877	PH3	50	1/4" (6.3 mm)	32.0	2	50/500



YATO	⊕	L (mm)	⊘	torque / moment obrotowy max. (Nm)	PCS packing	📦
YT-77879	PH1	50	1/4" (6.3 mm)	5.0	3	50/500
	PH2			14.0		
	PH3			32.0		

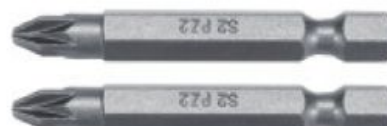

YATO	⊕	L (mm)	⊘	torque / moment obrotowy max. (Nm)	PCS packing	📦
YT-77883	PZ1	50	1/4" (6.3 mm)	5.0	2	50/500
YT-77884	PZ2	50	1/4" (6.3 mm)	14.0	2	50/500
YT-77885	PZ3	50	1/4" (6.3 mm)	32.0	2	50/500

GB Screwdriver bit set
D Schraubendreherbitsatz
PL Zestaw końcówek śrubokrętowych
RUS Набор битов
CZ Sada bitů
H Bitkészlet

RO Truse bit
F Embouts de vissage
I Set punte cacciavite
E Puntas de destornilladora
CN 旋具头组套



SLIDING CARD



COLD FORGED KUTE NA ZIMNO
218_{Nm} max.
AISI S2
HRC 58-62



YATO	+	L (mm)	⊕	📦
YT-0470	PZ1	25	1/4" (6.3 mm)	25/200
YT-0471	PZ2	25	1/4" (6.3 mm)	25/200
YT-0472	PZ3	25	1/4" (6.3 mm)	25/200

YATO	+	L (mm)	⊕	📦
YT-0477	PH1	50	1/4" (6.3 mm)	25/100
YT-0478	PH2	50	1/4" (6.3 mm)	25/100
YT-0479	PH3	50	1/4" (6.3 mm)	25/100
YT-0480	PH2	75	1/4" (6.3 mm)	25/100

YATO	+	L (mm)	⊕	📦
YT-0473	PH0	25	1/4" (6.3 mm)	25/200
YT-0474	PH1	25	1/4" (6.3 mm)	25/200
YT-0475	PH2	25	1/4" (6.3 mm)	25/200
YT-0476	PH3	25	1/4" (6.3 mm)	25/200

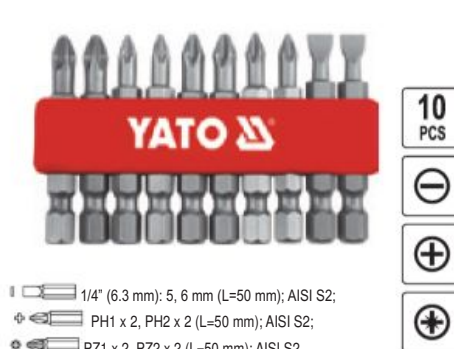

YATO	+	L (mm)	⊕	📦
YT-0481	PH2	65	1/4" (6.3 mm)	25/100

YATO	+	L (mm)	⊕	📦
YT-0482		25	1/4" (6.3 mm)	25/200

YATO	+	L (mm)	⊕	📦
YT-0483		50	1/4" (6.3 mm)	25/100

GB Screwdriver bit
D Schraubendreherbit
PL Końcówka śrubokrętowa
RUS Бит крестовая
CZ Šroubovaková koncovka
H Csavarhúzóvég

RO Capăt pt. șurubelniță
F Douille tournevis
I Punta del cacciavite
E Punta de destornilladora
CN 旋具头

COLOR BOX



AISI S2
HRC 58-62
COLD FORGED KUTE NA ZIMNO



YATO	+	L (mm)	⊕	PCS packing	📦
YT-7807	PH1	25	1/4" (6.3 mm)	50	20/40
YT-7808	PH2	25	1/4" (6.3 mm)	50	20/40
YT-7809	PH3	25	1/4" (6.3 mm)	50	20/40



YATO	+	L (mm)	⊕	PCS packing	📦
YT-7810	PZ1	25	1/4" (6.3 mm)	50	20/40
YT-7811	PZ2	25	1/4" (6.3 mm)	50	20/40
YT-7812	PZ3	25	1/4" (6.3 mm)	50	20/40



YATO	+	L (mm)	⊕	PCS packing	📦
YT-7815	T15	25	1/4" (6.3 mm)	50	20/40



YATO	+	L (mm)	⊕	PCS packing	📦
YT-7848	PH2	50	1/4" (6.3 mm)	50	10/20



YATO	+	+	L (mm)	⊕	PCS packing	📦
YT-7881	PH2	PH2	65	1/4" (6.3 mm)	50	10/20
YT-7882	PH3	PH3	65	1/4" (6.3 mm)	50	10/20
YT-7883	PH1	PH2	65	1/4" (6.3 mm)	50	10/20

GB Screwdriver bit
D Schraubendreherbit
PL Końcówka śrubokrętowa
RUS Бит крестовая
CZ Šroubovaková koncovka
H Csavarhúzóvég

RO Capăt pt. șurubelniță
F Douille tournevis
I Punta del cacciavite
E Punta de destornilladora
CN 旋具头



• with limiter
• z ogranicznikiem

COLOR BOX



YATO	+	L (mm)	⊕	PCS packing	📦
YT-7980		25	1/4" (6.3 mm)	20	20/40

GB Screwdriver bit
D Schraubendreherbit
PL Końcówka śrubokrętowa
RUS Бит крестовая

CZ Šroubovaková koncovka
H Csavarhúzóvég
RO Capăt pt. șurubelniță
F Douille tournevis

I Punta del cacciavite
E Punta de destornilladora
CN 旋具头

SLIDING
CARD



2
PCS

1/4"
(6.3mm)

S2

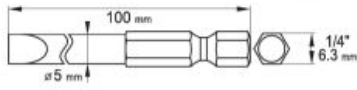

YATO	⊖	L (mm)	⊘	📦
YT-0484	4.0	100	1/4" (6.3 mm)	25/100
	5.0	100		

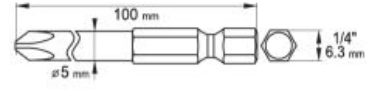

YATO	⊕	L (mm)	⊘	📦
YT-0459	PH00	100	1/4" (6.3 mm)	25/100
	PH0	100		

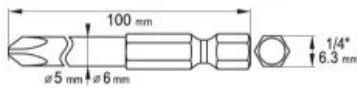

YATO	⊕	L (mm)	⊘	📦
YT-0488	PH1	100	1/4" (6.3 mm)	25/100
	PH2	100		

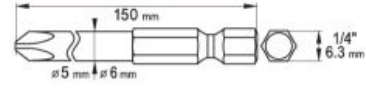

YATO	⊕	L (mm)	⊘	📦
YT-0489	PH1	150	1/4" (6.3 mm)	25/100
	PH2	150		

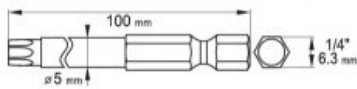

YATO	⊗	L (mm)	⊘	📦
YT-0490	T10	100	1/4" (6.3 mm)	25/100
	T25	100		

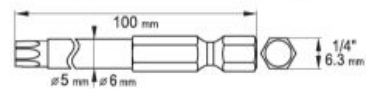

YATO	⊗	L (mm)	⊘	📦
YT-0491	T15	100	1/4" (6.3 mm)	25/100
	T27	100		
YT-0492	T20	100	1/4" (6.3 mm)	25/100
	T30	100		

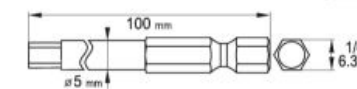

YATO	⊗	L (mm)	⊘	📦
YT-0494	3.0	100	1/4" (6.3 mm)	25/100
	5.0	100		

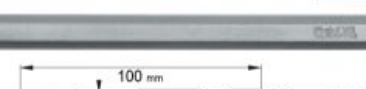
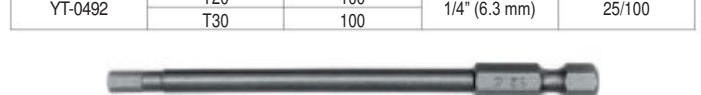

YATO	⊗	L (mm)	⊘	📦
YT-0495	4.0	100	1/4" (6.3 mm)	25/100
	6.0	100		

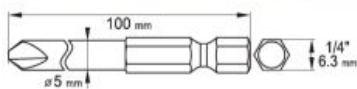

YATO	⊗	L (mm)	⊘	📦
YT-0493	#0	100	1/4" (6.3 mm)	25/100
	#1	100		

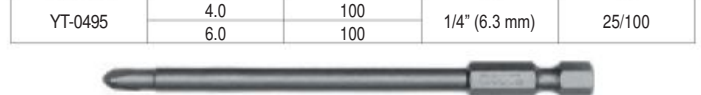

YATO	⊗	L (mm)	⊘	📦
YT-0497	#2	100	1/4" (6.3 mm)	25/100
	#4	100		

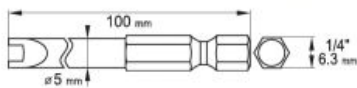

YATO	⊗	L (mm)	⊘	📦
YT-0498	#4	100	1/4" (6.3 mm)	25/100
	#8	100		

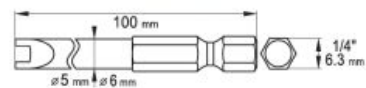

YATO	⊗	L (mm)	⊘	📦
YT-0499	#6	100	1/4" (6.3 mm)	25/100
	#10	100		

- GB Screwdriver bit set
- D Schraubendreherbitsatz
- PL Zestaw końcówek śrubokrętowych
- RUS Набор битов
- CZ Sada bitů
- H Bitkészlet
- RO Truse bit
- F Embouts de vissage
- I Set punte cacciavite
- E Puntas de destornilladora
- CN 旋具头组套



7
PCS



3/8" (9.5 mm): T25, T30, T40, T45, T50, T55 (L=30 mm); AISI S2;
1/2" (12.7 mm) x 3/8" (9.5 mm), CrV 6150

HANGING
COLOR
BOX

YATO
YT-0410 24/72

3/8" (9.5 mm): 4, 5, 6, 7, 8, 10, 12 mm (L=30 mm); 4, 5, 6, 7, 8, 10, 12 mm (L=75 mm); AISI S2;
3/8" (9.5 mm): M5, M6, M8, M10, M12 (L=30 mm); M5, M6, M8, M10, M12 (L=75 mm); AISI S2;
3/8" (9.5 mm): T20, T25, T30, T40, T45, T50, T55 (L=30 mm); T20, T25, T30, T40, T45, T50, T55 (L=75 mm); AISI S2;
1/2" (12.7 mm) x 3/8" (9.5 mm), 3/8" (9.5 mm) x 3/8" (9.5 mm); CrV 6150

218
max.
AISII
S2
HRC
58-62

40
PCS
HEX
SPLINE
TORX

METAL CASE
& COLOR BOX

YATO
YT-0400 10



3/8" (9.5 mm): T20, T25, T30, T40, T45, T50, T55 (L=30 mm); T20, T25, T30, T40, T45, T50, T55 (L=75 mm); AISI S2;
1/2" (12.7 mm) x 3/8" (9.5 mm), CrV 6150

15
PCS



METAL CASE
& COLOR BOX

YATO
YT-0411 20

7
PCS



3/8" (9.5 mm): 4, 5, 6, 8, 10, 12 mm (L=30 mm); AISI S2;
1/2" (12.7 mm) x 3/8" (9.5 mm), CrV 6150

HANGING
COLOR
BOX

YATO
YT-0412 24/72



3/8" (9.5 mm): 4, 5, 6, 7, 8, 10, 12 (L=30 mm); 4, 5, 6, 7, 8, 10, 12 (L=75 mm); AISI S2;
1/2" (12.7 mm) x 3/8" (9.5 mm), CrV 6150

15
PCS



METAL CASE
& COLOR BOX

YATO
YT-0413 20

6
PCS



3/8" (9.5 mm): M5, M6, M8, M10, M12 (L=30 mm); AISI S2;
1/2" (12.7 mm) x 3/8" (9.5 mm), CrV 6150

HANGING
COLOR
BOX

YATO
YT-0414 24/72



3/8" (9.5 mm): M5, M6, M8, M10, M12 (L=30 mm); M5, M6, M8, M10, M12 (L=75 mm); AISI S2;
1/2" (12.7 mm) x 3/8" (9.5 mm), CrV 6150

11
PCS



METAL CASE
& COLOR BOX

YATO
YT-0415 20

7
PCS



3/8" (9.5 mm): T25, T30, T40, T45, T50, T55 (L=30 mm); AISI S2;
1/2" (12.7 mm) x 3/8" (9.5 mm), CrV 6150

HANGING
COLOR
BOX

YATO
YT-0416 24/72



3/8" (9.5 mm): T20, T25, T30, T40, T45, T50, T55 (L=30 mm); T20, T25, T30, T40, T45, T50, T55 (L=75 mm); AISI S2;
1/2" (12.7 mm) x 3/8" (9.5 mm), CrV 6150

15
PCS



METAL CASE
& COLOR BOX

YATO
YT-0417 20

8
PCS



3/8" (9.5 mm): M5, M6, M7, M8, M10, M12, M14 (L=30 mm); AISI S2;
1/2" (12.7 mm) x 3/8" (9.5 mm), CrV 6150

HANGING
COLOR
BOX

YATO
YT-0418 24/72



3/8" (9.5 mm): M6, M7, M8, M9, M10, M12, M14 (L=30 mm); M6, M7, M8, M9, M10, M12, M14 (L=75 mm); AISI S2;
1/2" (12.7 mm) x 3/8" (9.5 mm), CrV 6150

15
PCS



METAL CASE
& COLOR BOX

YATO
YT-0419 20



42
PCS
RIBE
TORX
TAMPERPROOF

3/8" (9.5 mm): T20, T25, T30, T40, T45, T50, T55, T60, T70 (L=30 mm); T20, T25, T30, T40, T45, T50, T55, T60, T70; (L=75 mm); AISI S2;
3/8" (9.5 mm): M4, M5, M6, M7, M8, M9, M10, M11, M12, M13, M14 (L=30 mm); M4, M5, M6, M7, M8, M9, M10, M11, M12, M13, M14 (L=75 mm); AISI S2;
1/2" (12.7 mm) x 3/8" (9.5 mm), 3/8" (9.5 mm) x 3/8" (9.5 mm); CrV 6150

METAL CASE
& COLOR BOX

YATO
YT-0420 10

GB Screwdriver bit set
D Schraubendreherbitsatz
PL Zestaw końcówek śrubokrętowych

RUS Набор битов
CZ Sada bitů
H Bitkészlet

RO Truse bit
F Embouts de vissage
I Set punte cacciavite

E Puntas de destornilladora
CN 旋具头组套

1/4"
6.3mm S2



23
PCS



- 1/4" (6.3 mm): PH0, 2 x PH2, PH3 (L=25 mm); S2;
- 1/4" (6.3 mm): PZ0, 2 x PZ2, PZ3 (L=25 mm); S2;
- 1/4" (6.3 mm): 2 x T20, 2 x T25, 2 x T30, T40 (L=25 mm); S2;
- 1/4" (6.3 mm): 4, 5, 6 mm (L=25 mm); S2;
- 1/4" (6.3 mm): PH2 (L=50 mm); S2;
- 1/4" (6.3 mm): PZ2 (L=50 mm); S2;
- 1/4" (6.3 mm): T20, T30 (L=50 mm); S2;
- 1/4" (6.3 mm): (L=60 mm); CrV

PLASTIC BOX



YATO

YT-04621

20



32
PCS



- 1/4" (6.3 mm): 3, 4, 5, 6 mm (L=25 mm); S2;
- 1/4" (6.3 mm): PH1, 2 x PH2, PH3 (L=25 mm); S2;
- 1/4" (6.3 mm): PZ1, 2 x PZ2, PZ3 (L=25 mm); S2;
- 1/4" (6.3 mm): T10, T15, T20, T25, T27, T30, T40 (L=25 mm); S2;
- 1/4" (6.3 mm): T10, T15, T20, T25, T27, T30, T40 (L=25 mm); S2;
- 1/4" (6.3 mm): 3, 4, 5, 6 mm (L=25 mm); S2;
- 1/4" (6.3 mm): (L=70 mm); CrV;
- 1/4" (6.3 mm); (L=25 mm); S2

PLASTIC BOX



YATO

YT-04622

20



34
PCS



- 1/4" (6.3 mm): 5, 6, 7, 8, 9, 10, 11, 12 mm (L=25 mm);
- 1/4" (6.3 mm); (L=75 mm);
- 1/4" (6.3 mm): 3, 4, 2 x 5.5, 2 x 6.5 mm (L=25 mm); S2;
- 1/4" (6.3 mm): 2 x PH1, 2 x PH2, 2 x PH3 (L=25 mm); S2;
- 1/4" (6.3 mm): 2 x PZ1, 2 x PZ2, 2 x PZ3 (L=25 mm); S2;
- 1/4" (6.3 mm): T10, T15, T20, T25, T27, T30 (L=25 mm); S2;
- 1/4" (6.3 mm); (L=60 mm); CrV

PLASTIC BOX



YATO

YT-04623

20



40
PCS



- 1/4" (6.3 mm): 3, 4, 5, 6, 7 mm (L=25 mm); S2;
- 1/4" (6.3 mm): PH0, PH1, PH2, PH3 (L=25 mm); S2;
- 1/4" (6.3 mm): PZ0, PZ1, PZ2, PZ3 (L=25 mm); S2;
- 1/4" (6.3 mm): T8, T10, T15, T20, T25, T27, T30, T40 (L=25 mm); S2;
- 1/4" (6.3 mm): 2, 2.5, 3, 4, 5, 5.5, 2 x 6 mm (L=25 mm); S2;
- 1/4" (6.3 mm): S1, S2, S3 (L=25 mm); S2;
- 1/4" (6.3 mm): PH1, PH2 (L=50 mm); S2;
- 1/4" (6.3 mm): PZ1, PZ2 (L=50 mm); S2;
- 1/4" (6.3 mm): 5 mm x PH1, 6 mm x PH2, 6 mm x PH3 (L=65 mm); S2;
- 1/4" (6.3 mm): PH2 x PH2, PH2 x PH3 (L=65 mm); S2;
- 1/4" (6.3 mm): PZ1 x PZ1, PZ2 x PZ2, PZ3 x PZ3 (L=65 mm); S2;
- 1/4" (6.3 mm); (L=60 mm); S2

PLASTIC BOX & DOUBLE BLISTER



YATO

YT-04620

20



59
PCS



- 1/4" (6.3 mm): 2, 4, 6.5 mm (L=25 mm); S2;
- 1/4" (6.3 mm): PH0, 2 x PH1, 2 x PH2, PH3 (L=25 mm); S2;
- 1/4" (6.3 mm): 2 x PZ1, 2 x PZ2, PZ3 (L=25 mm); S2;
- 1/4" (6.3 mm): T10, T15, T20, T25, T30, T40 (L=25 mm); S2;
- 1/4" (6.3 mm): T8, T9, T10, T15, T20, T25, T27, T30, T40 (L=25 mm); S2;
- 1/4" (6.3 mm): 2, 2.5, 3, 4, 5, 6, 8 mm (L=25 mm); S2;
- 1/4" (6.3 mm): 0, 1, 2, 3 (L=25 mm); S2;
- 1/4" (6.3 mm): 1, 2, 3, 4 mm (L=25 mm); S2;
- 1/4" (6.3 mm): 6, 8, 10 mm (L=25 mm); S2;
- 1/4" (6.3 mm): 4, 6, 8, 10 mm (L=25 mm); S2;
- 1/4" (6.3 mm): M5, M6, M8 (L=25 mm); S2;
- 1/4" (6.3 mm): C1, C2, C3 (L=25 mm); S2;
- 1/4" (6.3 mm); (L=70 mm); CrV;
- 1/4" (6.3 mm); CrV

PLASTIC BOX



YATO

YT-04624

20

GB Nut setter
D Magnet-Steckschlüssel mit Adapter
PL Nasadka magnetyczna do wkrętarki
RUS Магнитная головка для винтовёрта

CZ Nástrčný kľúč magnetický do vrtačky
H Csavarbehajtó
RO Cheie tubulara cu prindere tip mandrina
F Douille tournevis magnétique

I Cappuccio magnetico la vite
E Boquilla magnética de destornilladora
CN 磁性套筒

L(mm) **48** **CrV 6150**



COLOR BOX

SLIDING CARD

YATO	Hex	PCS packing	Box	YATO	Hex	Box
YT-1501	6	20	200/600	YT-1511	6	100/200
YT-1502	7	20	200/600	YT-1512	7	100/200
YT-1503	8	20	200/600	YT-1513	8	100/200
YT-1505	10	20	200/600	YT-1515	10	100/200
YT-1507	12	20	200/600	YT-1517	12	100/200
YT-1508	13	20	200/600	YT-1518	13	100/200

5

GB Screwdriver bit holder
D Bithalter
PL Uchwyt do końcówek śrubokrętowych

RUS Магнитный держатель
CZ Držák na šroubovavokónconcovky
H Szár a csavarhúzóvégekhez

RO Capete şurubelniță
F Mandrin magnétique
I Mandrino portapunta

E Mandril para puntas
CN 旋具磁性接杆

SLIDING CARD **1/4"**
6.3mm

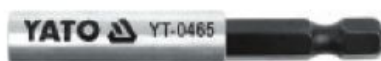

SS
STAINLESS STEEL
ÉTEL NEMZŐVÉNY

YATO	Hex	L (mm)	Box
YT-0465	1/4" (6.3 mm)	60	20/200

YATO	Hex	L (mm)	Box
YT-0466	1/4" (6.3 mm)	60	20/200



ELASTIC COVER

YATO	Hex	L (mm)	Box
YT-0467	1/4" (6.3 mm)	80	20/200

YATO	Hex	L (mm)	Box
YT-04671	1/4" (6.3 mm)	120	100



QUICK CONNECT
SZYBKÓZLÁÇZE
SS
STAINLESS STEEL
ÉTEL NEMZŐVÉNY

CrV

YATO	Hex	L (mm)	Box
YT-0468	1/4" (6.3 mm)	60	20/200

YATO	Hex	L (mm)	Box
YT-04695	1/4" (6.3 mm)	150	100

GB Screwdriver bit holder
D Bithalter
PL Uchwyt do końcówek śrubokrętowych
RUS Магнитный держатель
CZ Držák na šroubovavokónconcovky
H Szár a csavarhúzóvégekhez

RO Capete şurubelniță
F Mandrin magnétique
I Mandrino portapunta
E Mandril para puntas
CN 旋具磁性接杆

SLIDING CARD

1/4"
6.3mm



YATO	Hex	L (mm)	Box
YT-04681	1/4" (6.3 mm)	150	50/100
YT-04682	1/4" (6.3 mm)	200	50/100
YT-04683	1/4" (6.3 mm)	250	50/100
YT-04684	1/4" (6.3 mm)	300	50/100

GB Adapter
D Adapter
PL Adapter
RUS Адаптер
CZ Adaptory
H Adapter

RO Adaptor
F Adaptateur
I Adattatore
E Adaptador
CN 接杆组套

SLIDING CARD

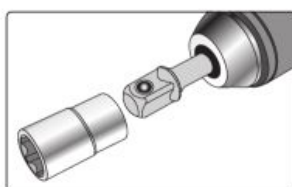

1/4"
6.3mm
3/8"
10mm
1/2"
12.5mm

GB Adapter
D Adapter
PL Adapter
RUS Адаптер
CZ Adaptory
H Adapter
RO Adaptor
F Adaptateur
I Adattatore
E Adaptador
CN 接杆组套



1/4"
6.3mm
SDS PLUS



1/4"
6.3mm
1/4" (6.3 mm), L=65 mm
3/8" (9.5 mm), L=65 mm
1/2" (12.7 mm), L=73 mm

SDS PLUS
1/4" (6.3 mm), L=65 mm
3/8" (9.5 mm), L=65 mm
1/2" (12.7 mm), L=65 mm

YATO	Box
YT-04685	20/100

YATO	Box
YT-04686	20/100



HEX 1/4" (6.3 mm) / SDS PLUS
L=60 mm

SLIDING CARD

YATO	L (mm)	Box
YT-04690	60	50/100

GB Extension bar
D Verlängerung
PL Przedłużka elastyczna
RUS Удлинитель для воротка

CZ Prodlužovací přípravek
H Toldalék
RO Prelungitor
F Rallonge élastique

I Prolunga flessibile
E Tubo de prolongación
CN 可弯式接杆

COLOR BOX



1/4" CrV
6.3mm 6140

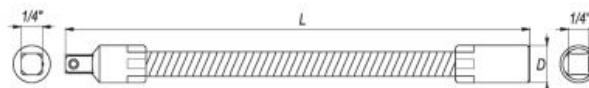

YATO	Ø	Ø	D (mm)	L (mm)	PCS packing	Box
YT-1400	1/4" (6.3 mm)	1/4" (6.3 mm)	11.6	150	25	250/500

GB Extension bar
D Verlängerung
PL Przedłużka elastyczna
RUS Удлинитель для воротка

CZ Prodlužovací přípravek
H Toldalék
RO Prelungitor
F Rallonge élastique

I Prolunga flessibile
E Tubo de prolongación
CN 可弯式接杆

1/4" CrV
6.3mm 6140

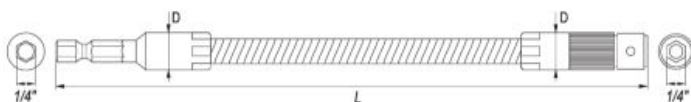

YATO	Ø	Ø	D (mm)	L (mm)	Box
YT-14001	1/4" (6.3 mm)	1/4" (6.3 mm)	11.7	300	100

SLIDING CARD

GB Angled screwdriver bit holder
D Winkelschrauber
PL Wkrętak kątowy do końcówek śrubokrętowych
RUS Г-образный держатель для бит
CZ Šroubovak
H Csavarhúzó

RO Șurubelniță 90 grade cu cap hexagonal pt. biti
F Mandrin magnétique
I Cacciavite ad angolo per punte
E Porta pontas magnético
CN 直角螺丝批接头

1/4" 105 mm
90°

SLIDING CARD



YATO	Ø	L (mm)	Box
YT-04630	1/4" (6.3 mm)	105	60/240

GB Angle adapter
D Winkelschrauber
PL Adapter kątowy
RUS Адаптер угловой для бит
CZ Úhel elektrická vrtačka připojení adaptéru
H Sarokcsavarozó adapter
RO Dispozitiv unghiular de insurubat
F Renvoi d'angle perceuse visseuse
I Adattatore
E Ángulo magnético bit driver adaptador
CN 带手柄拐螺丝批接头

1/4" 1200 min⁻¹ 105° 12 Nm SS



SLIDING CARD

YATO	Ø	L (mm)	Box
YT-04632	1/4" (6.3 mm)	37	100

GB Angle adapter
D Winkelschrauber
PL Adapter kątowy
RUS Адаптер угловой для бит
CZ Úhel elektrická vrtačka připojení adaptéru
H Sarokcsavarozó adapter
RO Dispozitiv unghiular de insurubat
F Renvoi d'angle perceuse visseuse
I Adattatore
E Ángulo magnético bit driver adaptador
CN 带手柄拐螺丝批接头



SLIDING CARD



1/4" 400 min⁻¹ 90°
13 Nm

YATO	Ø	L (mm)	Box
YT-04631	1/4" (6.3 mm)	155	50

GB Insulated hex key
D Steckschlüssel
PL Klucz sześciokątny izolowany
RUS Накидной гаечный ключ угловой

CZ Imbusové klíče izolované
H Imbisz kulcs
RO Imbusuri hexagonale izolate
F Clés allen isolée

I Chiave esagonale isolato
E Punta vaso aislante
CN 绝缘内六角扳手

POLYBAG

HEX CrV 1000 V

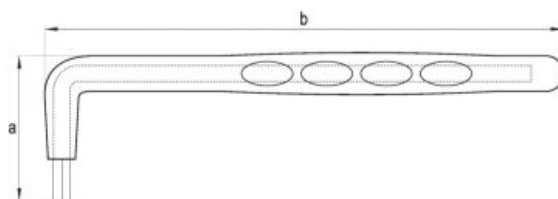
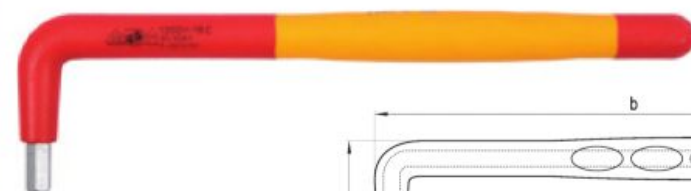

1000V VDE CERTIFICATE EN 60900:2012

YATO	Ø (mm)	a (mm)	b (mm)	Box
YT-21120	3.0	25	130	12/144
YT-21121	4.0	40	140	12/144
YT-21122	5.0	45	160	12/144
YT-21123	6.0	47	180	10/120
YT-21125	8.0	50	200	10/120
YT-21126	10.0	52	235	6/48
YT-21127	12.0	60	260	6/48

GB Hex with ball with handle
D Aufsteckschlüssel
PL Klucz trzpieniowy z rączką
RUS Ключ торцевой
CZ Čepový klíč
H Csapkulcs
RO Chei cu cozi
F Tournevis 6 pans à boule
I Cacciavite a brugola con testina a sfera
E Llave de mandril
CN 球头内六角螺丝批



COLOR BOX



SVC M 55 HRC 55-59

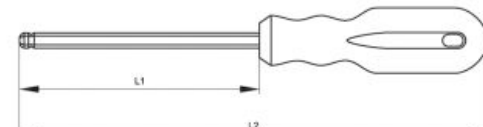

YATO	Ø (mm)	L1 (mm)	L2 (mm)	PCS packing	Box
YT-1532	3.0	100	200	12	240
YT-1533	4.0	100	205	12	240
YT-1534	5.0	100	205	12	240
YT-1535	6.0	125	242	12	240
YT-1537	8.0	150	278	6	120
YT-1539	10.0	150	278	6	120

GB T-handle key
 D T-Griff Stiftschlüssel
 PL Klucz tyru „T”
 RUS Ключ T-образный с рукояткой
 CZ Imbusový klíč s T-rukojetí

H Imbuszkulcs T-markolattal
 RO Cheie tip „T”
 F Clé allen avec en „T”

I Chiave a „T” per viti con impronta
 E Llave allen con mango en „T”
 CN T型内六角扳手

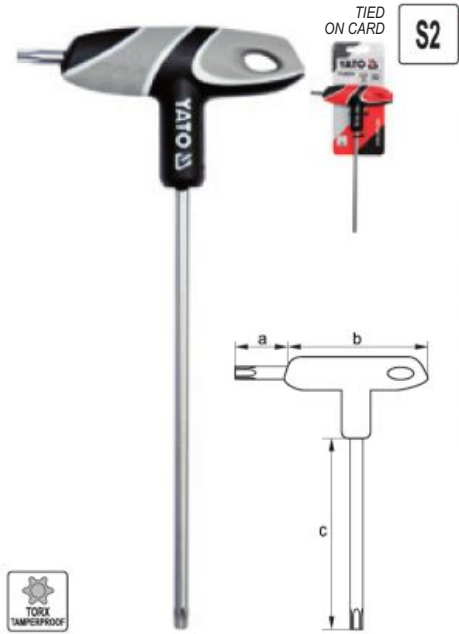

YATO	Ø (mm)	a (mm)	b (mm)	c (mm)	Box
YT-05601	T8	13	76	100	12/240
YT-05602	T9	13	76	100	12/240
YT-05603	T10	13	76	100	12/240
YT-05604	T15	13	76	100	12/240
YT-05605	T20	13	76	130	12/240
YT-05606	T25	13	76	130	12/240
YT-05607	T27	17	92	140	12/144
YT-05608	T30	17	92	170	12/144
YT-05609	T40	17	92	170	12/144
YT-05610	T45	22	102	200	12/96
YT-05611	T50	22	102	200	12/96

YATO	Ø (mm)	a (mm)	b (mm)	c (mm)	Box
YT-05571	2.5	13	76	100	12/240
YT-05572	3.0	13	76	100	12/240
YT-05574	4.0	13	76	140	12/240
YT-05576	5.0	17	92	140	12/144
YT-05577	6.0	17	92	170	12/144
YT-05578	7.0	17	92	170	12/144
YT-05579	8.0	22	102	200	12/96
YT-05581	10.0	22	102	200	12/96

YATO	Ø (mm)	a (mm)	b (mm)	c (mm)	Box
YT-05585	2.5	13	76	100	12/240
YT-05586	3.0	13	76	100	12/240
YT-05588	4.0	13	76	140	12/240
YT-05590	5.0	17	92	140	12/144
YT-05591	6.0	17	92	170	12/144
YT-05592	7.0	17	92	170	12/144
YT-05593	8.0	22	102	200	12/96
YT-05594	10.0	22	102	200	12/96

GB T-handle key
 D T-Griff Stiftschlüssel
 PL Klucz tyru „T”
 RUS Ключ T-образный с рукояткой

CZ Imbusový klíč s T-rukojetí
 H Imbuszkulcs T-markolattal
 RO Cheie tip „T”
 F Clé allen avec en „T”

I Chiave a „T” per viti con impronta
 E Llave allen con mango en „T”
 CN T型内六角扳手



YATO	Ø (mm)	a (mm)	b (mm)	c (mm)	Box
YT-05583	2.5	13	76	100	12/24
	3.0	13	76	100	
	4.0	13	76	140	
	5.0	17	92	140	
	6.0	17	92	170	
	7.0	17	92	170	
	8.0	22	102	200	
	10.0	22	102	200	

YATO	Ø (mm)	a (mm)	b (mm)	c (mm)	Box
YT-05597	2.5	13	76	100	12/24
	3.0	13	76	100	
	4.0	13	76	140	
	5.0	17	92	140	
	6.0	17	92	170	
	7.0	17	92	170	
	8.0	22	102	200	
	10.0	22	102	200	

YATO	Ø (mm)	a (mm)	b (mm)	c (mm)	Box
YT-05615	T10	13	76	100	12/24
	T15	13	76	100	
	T20	13	76	100	
	T25	13	76	140	
	T27	17	92	140	
	T30	17	92	170	
	T40	17	92	170	
	T45	22	102	200	
	T50	22	102	200	

CrV

- GB Hex key CZ Imbusový klíč I Chiave a brugola
D Sechskant-Stiftschlüssel H Imbisz kulcs E Llave hexagonal
PL Klucz sześciokątny RO Cheie imbus CN 内六角扳手
RUS Шестигранный F Clé Allen

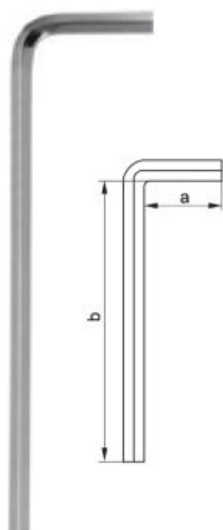

YATO	⌀ (mm)	a (mm)	b (mm)	📦
YT-05430	1.5	14	78	250/2000
YT-05431	2.0	16	83	250/2000
YT-05432	2.5	18	90	250/1500
YT-05433	3.0	20	100	250/1500
YT-05434	4.0	25	105	250/1000
YT-05435	4.5	27	110	50/600
YT-05436	5.0	27	116	100/600
YT-05437	5.5	30	128	100/500
YT-05438	6.0	32	137	100/500
YT-05439	7.0	34	150	100/300
YT-05440	8.0	36	155	50/200
YT-05441	9.0	38	165	25/125
YT-05442	10.0	40	170	25/125
YT-05443	12.0	47	210	25/75
YT-05444	14.0	57	236	25/50
YT-05445	17.0	63	250	15/30
YT-05446	19.0	70	280	10/20

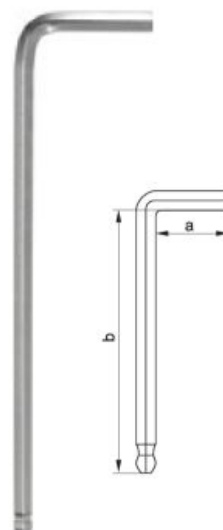

YATO	⌀ (mm)	a (mm)	b (mm)	📦
YT-05450	1.5	14	78	250/2000
YT-05451	2.0	16	83	250/2000
YT-05452	2.5	18	90	250/2000
YT-05453	3.0	20	100	250/1500
YT-05454	4.0	25	105	250/1000
YT-05455	4.5	27	110	50/650
YT-05456	5.0	27	116	100/600
YT-05457	5.5	30	128	100/500
YT-05458	6.0	32	137	100/500
YT-05459	7.0	34	150	100/300
YT-05460	8.0	36	155	50/200
YT-05461	9.0	38	165	25/125
YT-05462	10.0	40	170	25/125
YT-05463	12.0	47	210	25/75
YT-05464	14.0	57	236	25/50
YT-05465	17.0	63	250	15/30
YT-05466	19.0	70	280	10/20

- GB TORX key CZ Klíč TORX I Chiave TORX
D TORX-Stiftschlüssel H Kulcs TORX E Llave TORX
PL Klucz TORX RO Cheie TORX CN 内六角扳手
RUS Ключ TORX F Clé TORX

CrV



YATO	⌀ (mm)	a (mm)	b (mm)	📦
YT-05490	T6	16	66	250/2000
YT-05491	T7	16	71	250/2000
YT-05492	T8	16	80	250/2000
YT-05493	T9	16	80	250/2000
YT-05494	T10	17	86	250/2000
YT-05495	T15	17	90	250/2000
YT-05496	T20	19	95	100/1000
YT-05497	T25	20	100	100/1000
YT-05498	T27	21	105	100/1000
YT-05499	T30	24	114	50/600
YT-05501	T40	28	121	50/400
YT-05502	T45	30	132	25/250
YT-05503	T50	32	152	25/200



YATO	⌀ (mm)	a (mm)	b (mm)	📦
YT-05513	T9	16	80	250/2000
YT-05514	T10	17	86	250/2000
YT-05515	T15	17	90	250/2000
YT-05516	T20	19	95	250/1000
YT-05517	T25	20	100	250/1000
YT-05518	T27	21	105	250/1000
YT-05519	T30	24	114	50/600
YT-05520	T40	28	121	50/400
YT-05521	T45	30	132	25/250
YT-05522	T50	32	152	25/200

- GB TORX key set
D TORX-Stiftschlüsselsatz
PL Zestaw kluczy TORX
RUS Набор ключей TORX
CZ Souprava klíčů TORX
H Kulcskészlet, TORX
RO Set de chei TORX
F Set de clés Allen
I Set di chiavi a brugola
E Juego de llaves TORX
CN 内六角扳手组套

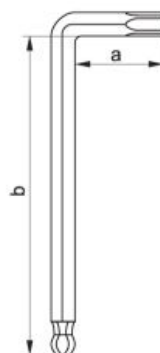

PLASTIC HANGER & SLIDING CARD



YATO	⌀ (mm)	a (mm)	b (mm)	📦
YT-05123	T9	18	85	10/100
	T10	18	90	
	T15	19	95	
	T20	20	100	
	T25	21	107	
	T27	23	115	
	T30	25	123	
T40	27	132		

GB Hex key set
 D Sechskant-Stiftschlüsselsatz
 PL Zestaw kluczy imbusowych
 RUS Набор шестигранников
 CZ Imbusové klíče
 H Imbisz kulcs

RO Chei imbus
 F Set de clés Allen
 I Set di chiavi a brugola
 E Juego de llaves hex
 CN 内六角扳手组套

PLASTIC HANGER
 & SLIDING CARD

12 PCS CrV 6150 S.A.E.

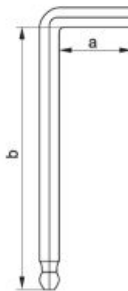
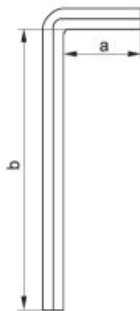

YATO	Ø (mm)	a (mm)	b (mm)	Box
YT-5835	1/16" (1.6 mm)	14	74	6/36
	5/64" (2.0 mm)	16	79	
	3/32" (2.4 mm)	17	83	
	7/64" (2.8 mm)	18	88	
	1/8" (3.2 mm)	19	93	
	9/64" (3.6 mm)	20	99	
	5/32" (4.0 mm)	21	105	
	3/16" (4.8 mm)	24	113	
	7/32" (5.6 mm)	25	122	
	1/4" (6.3 mm)	28	132	
5/16" (7.9 mm)	32	150		
3/8" (9.5 mm)	35	170		

YATO	Ø (mm)	a (mm)	b (mm)	Box
YT-5837	1/16" (1.6 mm)	14	74	6/36
	5/64" (2.0 mm)	16	79	
	3/32" (2.4 mm)	17	83	
	7/64" (2.8 mm)	18	88	
	1/8" (3.2 mm)	19	93	
	9/64" (3.6 mm)	20	99	
	5/32" (4.0 mm)	21	105	
	3/16" (4.8 mm)	24	113	
	7/32" (5.6 mm)	25	122	
	1/4" (6.3 mm)	28	132	
5/16" (7.9 mm)	32	150		
3/8" (9.5 mm)	35	170		

YATO	Ø (mm)	a (mm)	b (mm)	Box
YT-5838	1/16" (1.6 mm)	14	91	6/36
	5/64" (2.0 mm)	16	100	
	3/32" (2.4 mm)	17	110	
	7/64" (2.8 mm)	18	116	
	1/8" (3.2 mm)	19	123	
	9/64" (3.6 mm)	20	130	
	5/32" (4.0 mm)	21	132	
	3/16" (4.8 mm)	24	150	
	7/32" (5.6 mm)	25	165	
	1/4" (6.3 mm)	28	185	
5/16" (7.9 mm)	32	200		
3/8" (9.5 mm)	35	233		

GB Hex key set
 D Sechskant-Stiftschlüsselsatz
 PL Zestaw kluczy imbusowych
 RUS Набор шестигранников

CZ Imbusové klíče
 H Imbisz kulcs
 RO Chei imbus
 F Set de clés Allen

I Set di chiavi a brugola
 E Juego de llaves hex
 CN 内六角扳手组套

PLASTIC HANGER
 & SLIDING CARD

HEX CrV 6150 HRC 52-56



9 PCS

YATO	Ø (mm)	a (mm)	b (mm)	Box
YT-0500	1.5	15	74	6/36
	2.0	16	81	
	2.5	18	88	
	3.0	21	95	
	4.0	23	109	
	5.0	28	121	
	6.0	31	135	
	8.0	35	157	
	10.0	39	174	

9 PCS

YATO	Ø (mm)	a (mm)	b (mm)	Box
YT-0501	1.5	15	90	6/36
	2.0	16	96	
	2.5	18	112	
	3.0	21	125	
	4.0	23	142	
	5.0	28	157	
	6.0	31	180	
	8.0	35	201	
	10.0	39	225	

9 PCS

YATO	Ø (mm)	a (mm)	b (mm)	Box
YT-0502	2.0	16	81	6/36
	2.5	18	88	
	3.0	21	95	
	4.0	23	109	
	5.0	28	121	
	6.0	31	135	
	7.0	33	145	
	8.0	35	157	
	10.0	39	174	

10 PCS

YATO	Ø (mm)	a (mm)	b (mm)	Box
YT-0508	2.0	16	81	6/36
	2.5	18	88	
	3.0	21	95	
	4.0	23	109	
	5.0	28	121	
	6.0	31	135	
	7.0	33	145	
	8.0	35	157	
	10.0	39	174	
	12.0	42	180	

9 PCS

YATO	Ø (mm)	a (mm)	b (mm)	Box
YT-0505	1.5	15	74	6/36
	2.0	16	81	
	2.5	18	88	
	3.0	21	95	
	4.0	23	109	
	5.0	28	121	
	6.0	31	135	
	8.0	35	157	
	10.0	39	174	

9 PCS

YATO	Ø (mm)	a (mm)	b (mm)	Box
YT-0506	1.5	15	90	6/36
	2.0	16	96	
	2.5	18	112	
	3.0	21	125	
	4.0	23	142	
	5.0	28	157	
	6.0	31	180	
	8.0	35	201	
	10.0	39	225	

9 PCS

YATO	Ø (mm)	a (mm)	b (mm)	Box
YT-0507	2.0	16	81	6/36
	2.5	18	88	
	3.0	21	95	
	4.0	23	109	
	5.0	28	121	
	6.0	31	135	
	7.0	33	145	
	8.0	35	157	
	10.0	39	174	

10 PCS

YATO	Ø (mm)	a (mm)	b (mm)	Box
YT-0509	2.0	16	81	6/36
	2.5	18	88	
	3.0	21	95	
	4.0	23	109	
	5.0	28	121	
	6.0	31	135	
	7.0	33	145	
	8.0	35	157	
	10.0	39	174	
	12.0	42	180	

GB Hex key set
D Sechskant-Stiftschlüsselsatz
PL Zestaw kluczy imbusowych
RUS Набор шестигранников
CZ Imbusové klíče

H Imbisz kulcs
RO Chei imbus
F Set de clés Allen

I Set di chiavi a brugola
E Juego de llaves hex
CN 内六角扳手组套

POUCH



CrV
6150



8
PCS

YATO	Ø (mm)	a (mm)	b (mm)	
YT-0503	2.0	14	50	12/72
	2.5	16	53	
	3.0	17	60	
	4.0	21	66	
	5.0	22	74	
	6.0	27	81	
	8.0	32	93	
	10.0	38	104	

10
PCS

YATO	Ø (mm)	a (mm)	b (mm)	
YT-0504	1.5	12	43	12/72
	2.0	14	50	
	2.5	16	53	
	3.0	17	60	
	4.0	21	66	
	5.0	22	74	
	6.0	27	81	
	7.0	31	86	
	8.0	32	93	
	10.0	38	104	

GB Hex key set
D Sechskant-Stiftschlüsselsatz
PL Zestaw kluczy imbusowych
RUS Набор шестигранников
CZ Imbusové klíče
H Imbisz kulcs
RO Chei imbus
F Set de clés Allen
I Set di chiavi a brugola
E Juego de llaves hex
CN 内六角扳手组套

METAL CASE
& COLOR SLEEVE



10
PCS



CrV
6150

HRC
52-55



YATO	Ø (mm)	a (mm)	b (mm)	
YT-0519	3.0	20	125	5
	4.0	25	140	
	5.0	28	160	
	5.5	30	170	
	6.0	32	180	
	8.0	35	200	
	10.0	42	220	
	12.0	49	250	
	14.0	57	285	
	17.0	65	320	

GB TORX key set
D TORX-Stiftschlüsselsatz
PL Zestaw kluczy TORX
RUS Набор ключей TORX
CZ Souprava klíčů TORX
H Kulcskészlet, TORX
RO Set de chei TORX
F Set de clés Allen
I Set di chiavi a brugola
E Juego de llaves TORX
CN 内六角扳手组套

TORX TAMPERPROOF



PLASTIC
HANGER
& SLIDING
CARD



9
PCS



CrV
6150

HRC
52-56

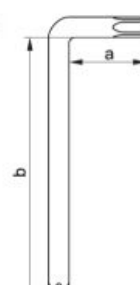

YATO	Ø	a (mm)	b (mm)	
YT-0511	T10	15	72	6/36
	T15	16	79	
	T20	17	86	
	T25	21	94	
	T27	24	107	
	T30	27	122	
	T40	32	133	
	T45	36	155	
T50	38	174		

YATO	Ø	a (mm)	b (mm)	
YT-0512	T10	15	78	6/36
	T15	16	95	
	T20	19	109	
	T25	23	124	
	T27	26	143	
	T30	27	153	
	T40	32	180	
	T45	36	200	
	T50	41	222	

GB Hex key set
D Sechskant-Stiftschlüsselsatz
PL Zestaw kluczy imbusowych
RUS Набор шестигранников
CZ Imbusové klíče
H Imbisz kulcs
RO Chei imbus
F Set de clés Allen
I Set di chiavi a brugola
E Juego de llaves hex
CN 内六角扳手组套

PLASTIC
HANGER



10
PCS



25°

S2

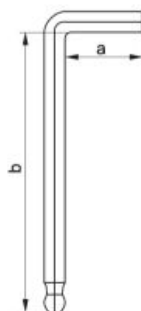

YATO	Ø (mm)	a (mm)	b (mm)	
YT-0560	1.27	12	73	12/48
	1.5	14	76	
	2.0	16	82	
	2.5	18	89	
	3.0	18	99	
	4.0	21	104	
	5.0	27	115	
	6.0	32	138	
	8.0	35	161	
	10.0	38	179	

YATO	Ø (mm)	a (mm)	b (mm)	
YT-0561	1.27	10	78	12/48
	1.5	12	89	
	2.0	15	98	
	2.5	17	110	
	3.0	19	124	
	4.0	23	140	
	5.0	28	159	
	6.0	32	179	
	8.0	36	198	
	10.0	50	232	

GB TORX key set
D TORX-Stiftschlüsselsatz
PL Zestaw kluczy TORX
RUS Набор ключей TORX
CZ Souprava klíčů TORX
H Kulcskészlet, TORX
RO Set de chei TORX
F Set de clés Allen
I Set di chiavi a brugola
E Juego de llaves TORX
CN 内六角扳手组套

TORX TAMPERPROOF



PLASTIC
HANGER



S2

7
PCS

YATO	Ø	a (mm)	b (mm)	
YT-0562	T9	18	78	12/48
	T10	19	85	
	T15	19	93	
	T20	19	103	
	T25	22	113	
	T27	24	123	
	T30	26	132	

9
PCS

YATO	Ø	a (mm)	b (mm)	
YT-0563	T10	14	87	12/48
	T15	14	97	
	T20	16	108	
	T25	18	123	
	T27	23	137	
	T30	27	158	
	T40	30	177	
	T45	35	197	
	T50	41	216	

6

Pliers & pipe wrenches Szczypce i klucze do rur



Pliers, CrV
Szczypce, CrV



95

Combination pliers	
Szczypce uniwersalne.....	95
Side cutting pliers	
Szczypce tnące, boczne.....	95
Long nose pliers	
Szczypce wydłużone, proste.....	95
Bent nose pliers	
Szczypce wydłużone, wygięte.....	95

Pliers
Szczypce



95-96

Combination pliers	
Szczypce uniwersalne.....	95
Side cutting pliers	
Szczypce tnące, boczne.....	95
Long nose pliers	
Szczypce wydłużone, proste.....	95
Bent nose pliers	
Szczypce wydłużone, wygięte.....	95
Flat nose pliers	
Szczypce płaskie.....	96
Round nose pliers	
Szczypce okrągłe.....	96
Wire stripping pliers	
Szczypce do ściągania izolacji.....	96
End cutting pliers	
Szczypce tnące, czołowe.....	96

Pliers, CrV
Szczypce, CrV



96

Combination pliers	
Szczypce uniwersalne.....	96
Side cutting pliers	
Szczypce tnące, boczne.....	96

Pliers
Szczypce



96

Combination pliers	
Szczypce uniwersalne.....	96
Side cutting pliers	
Szczypce tnące, boczne.....	96

Mini pliers
Szczypce „Mini”



97

Combination pliers	
Szczypce uniwersalne.....	97
Side cutting pliers	
Szczypce tnące, boczne.....	97
Long nose pliers	
Szczypce wydłużone, proste.....	97
Bent nose pliers	
Szczypce wydłużone, wygięte.....	97
Flat nose pliers	
Szczypce płaskie.....	97
Round nose pliers	
Szczypce okrągłe.....	97
End cutting pliers	
Szczypce tnące, czołowe.....	97

Insulated pliers
Szczypce izolowane



98

Combination pliers	
Szczypce uniwersalne.....	98
Side cutting pliers	
Szczypce tnące, boczne.....	98
Long nose pliers	
Szczypce wydłużone, proste.....	98
Wire stripping pliers	
Szczypce do ściągania izolacji.....	98
Water pump pliers	
Szczypce nastawne.....	98
Insulated flat nose pliers	
Klucze płaskie izolowane.....	98

Plastics & cables cutting pliers
Szczypce do cięcia plastiku i kabli



99

Side cutting pliers	
Szczypce tnące, boczne.....	99
Long nose pliers	
Szczypce wydłużone, proste.....	99

Carpenter's pliers & tower pincers
Obcęgi i szczypce



100

Carpenter's pliers	
Obcęgi.....	100
Tower pincers	
Szczypce tynkarskie.....	100

Heavy duty side cutting pliers
Szczypce tnące, boczne



100

End cutting pliers	
Szczypce tnące czołowe.....	100

Circlip pliers
Szczypce Segera



101-102

Lock grip pliers
Szczypce zaciskowe



103-105

Lock grip pliers	
Szczypce zaciskowe, uniwersalne.....	103
Welding locking pliers	
Szczypce zaciskowe, spawalnicze.....	104
Flat locking pliers	
Szczypce zaciskowe o szerokich szczękach.....	104
C-type welding locking pliers	
Szczypce zaciskowe, kłamrowe typu „C”.....	104
Chain locking pliers	
Szczypce zaciskowe z łańcuchem.....	104
Self-locking multi grip pliers	
Szczypce blacharskie.....	105



Profile connection & forming pliers
Szczypce do łączenia i kształtowania profili

105



Strap wrenches
Klucze do rur taśmowe

107



Water pump pliers
Szczypce nastawne

106



Chain pipe wrenches
Klucze do rur łańcuchowe

107



Pipe wrenches
Klucze do rur

106-107



Tweezers
Pęsety

107



GB Combination pliers
D Kombinationszange
PL Szczypce uniwersalne
RUS Плоскогубцы универсальные
CZ Kleště kombinované
H Kombináltfogó

RO Patent universal
F Pince universelle
I Pinze universali
E Alicates universales
CN 钢丝钳

160 mm
180 mm
200 mm
HRC 44-50 BODY
HRC 58-62 CUTTER
CrV 55
DIN 5746



HALF DOUBLE BLISTER

- application: industry
- induction hardening
- przeznaczenie: przemysł
- hartowane indukcyjnie

YATO	L (mm)	
YT-1940	160	6/60
YT-1941	180	6/60
YT-1942	200	6/36

GB Diagonal side cutting pliers
D Seitenschneider
PL Szczypce tnące boczne
RUS Бокорезы
CZ Řezací kleště boční
H Oldal csípőfogó

RO Olește tăietor
F Pince à coupe latérale
I Pinze taglianti laterali
E Alicates corte lateral
CN 斜嘴钳

160 mm
190 mm
HRC 44-50 BODY
HRC 58-62 CUTTER
CrV 55
DIN 5746



HALF DOUBLE BLISTER

- application: industry
- induction hardening
- przeznaczenie: przemysł
- hartowane indukcyjnie

YATO	L (mm)	
YT-1947	160	6/60
YT-1948	190	6/60

GB Long nose pliers
D Radiozange
PL Szczypce wydłużone proste
RUS Тонкогубцы прямые
CZ Prodloužené kleště rovné
H Rádiófogó, egyenes

RO Clește cu vârf ascuțit
F Pince prolongée
I Pinze lunghe diritte
E Alicates de punta
CN 尖嘴钳

160 mm
200 mm
HRC 44-50 BODY
HRC 58-62 CUTTER
CrV 55
DIN 5746



HALF DOUBLE BLISTER

- application: industry
- induction hardening
- przeznaczenie: przemysł
- hartowane indukcyjnie

YATO	L (mm)	
YT-1943	160	6/60
YT-1944	200	6/60

GB Bent nose pliers
D Telefonzange
PL Szczypce wydłużone wygięte
RUS Тонкогубцы изогнутые
CZ Prodloužené kleště ohnuté
H Rádió - és telefonfogó, hajlított

RO Clește cu vârf ascuțit indoit
F Pince prolongée cambrée
I Pinze a punte mezzo tonde
E Alicates de punta curvos
CN 弯嘴钳

160 mm
200 mm
HRC 44-50 BODY
HRC 58-62 CUTTER
CrV 55
DIN 5746



HALF DOUBLE BLISTER

- application: industry
- induction hardening
- przeznaczenie: przemysł
- hartowane indukcyjnie

YATO	L (mm)	
YT-1945	160	6/60
YT-1946	200	6/60

GB Combination pliers
D Kombinationszange
PL Szczypce uniwersalne
RUS Плоскогубцы универсальные
CZ Kleště kombinované
H Kombináltfogó

RO Patent universal
F Pince universelle
I Pinze universali
E Alicates universales
CN 钢丝钳

160 mm
180 mm
200 mm
DIN 5746
NICKEL IRON FINISH



HALF DOUBLE BLISTER

YATO	L (mm)	
YT-2006	160	6/60
YT-2007	180	6/60
YT-2008	200	6/36

GB Diagonal side cutting pliers
D Seitenschneider
PL Szczypce tnące boczne
RUS Бокорезы
CZ Řezací kleště boční
H Oldal csípőfogó

RO Olește tăietor
F Pince à coupe latérale
I Pinze taglianti laterali
E Alicates corte lateral
CN 斜嘴钳

160 mm
180 mm
DIN 5746
NICKEL IRON FINISH



HALF DOUBLE BLISTER

YATO	L (mm)	
YT-2036	160	6/60
YT-2037	180	6/60

GB Long nose pliers
D Radiozange
PL Szczypce wydłużone proste
RUS Тонкогубцы прямые
CZ Prodloužené kleště rovné
H Rádiófogó, egyenes

RO Clește cu vârf ascuțit
F Pince prolongée
I Pinze lunghe diritte
E Alicates de punta
CN 尖嘴钳

160 mm
200 mm
DIN 5746
NICKEL IRON FINISH



HALF DOUBLE BLISTER

YATO	L (mm)	
YT-2016	160	6/60
YT-2018	200	6/60

GB Bent nose pliers
D Telefonzange
PL Szczypce wydłużone wygięte
RUS Тонкогубцы изогнутые
CZ Prodloužené kleště ohnuté
H Rádió - és telefonfogó, hajlított

RO Clește cu vârf ascuțit indoit
F Pince prolongée cambrée
I Pinze a punte mezzo tonde
E Alicates de punta curvos
CN 弯嘴钳

160 mm
200 mm
DIN 5746
NICKEL IRON FINISH



HALF DOUBLE BLISTER

YATO	L (mm)	
YT-2026	160	6/60
YT-2028	200	6/60

GB Flat nose pliers
D Elektrikerflachzange
PL Szczypce płaskie
RUS Утконосы
CZ Prodloužené kleště rovné
H Rádiófogó, egyenes

RO Clește cu vârf ascuțit
F Pince plate
I Pinze piatte
E Alicates de bocas planas
CN 平嘴钳

160 mm DIN 5745 NICKEL IRON FINISH



HALF DOUBLE BLISTER

YATO	L (mm)	
YT-2029	160	6/60

GB Round nose pliers
D Rundzange
PL Szczypce okrągłe
RUS Круглогубцы
CZ Kleště kulaté
H Kerekcsőrű fogó

RO Patent rotund
F Pince ronde
I Pinze tonde
E Alicates de punta redonda
CN 圆嘴钳

160 mm DIN 5745 NICKEL IRON FINISH



HALF DOUBLE BLISTER

YATO	L (mm)	
YT-2030	160	6/60

GB Wire stripping pliers
D Abisolierzange
PL Szczypce do ściągania izolacji
RUS Пасатижи для зачистки проводов
CZ Kleště odizolovací na drát
H Blankoló fogó
RO Decablator

F Pince à l'isolation
I Pinze spelafili
E Pinzas pelacables
CN 剥线钳

160 mm DIN 5745 NICKEL IRON FINISH



HALF DOUBLE BLISTER

YATO	L (mm)	
YT-2031	160	6/60

GB End cutting pliers
D Vornschnaider
PL Szczypce tnące czolowe
RUS Кусачки торцевые
CZ Kleště štípací čelní
H Homlokcsipő fogó
RO Clește retezat

F Coupe devant
I Pinza a taglio laterale
E Cortacables frontales
CN 顶切钳

160 mm 180 mm DIN 5748 NICKEL IRON FINISH



HALF DOUBLE BLISTER

YATO	L (mm)	
YT-2066	160	6/60
YT-2067	180	6/60

GB Combination pliers
D Kombinationszange
PL Szczypce uniwersalne
RUS Плоскогубцы универсальные
CZ Kleště kombinované
H Kombináltfogó

RO Patent universal
F Pince universelle
I Pinze universali
E Alicates universales
CN 钢丝钳

160 mm 180 mm 200 mm CrV HRC 55-62



HALF DOUBLE BLISTER

YATO	L (mm)	
YT-6600	160	6/60
YT-6601	180	6/60
YT-6602	200	6/36

GB Diagonal side cutting pliers
D Seitenschneider
PL Szczypce tnące boczne
RUS Бокорезы
CZ Řezací kleště boční
H Oldal csipőfogó

RO Olește tăietor
F Pince à coupe latérale
I Pinze taglianti laterali
E Alicates corte lateral
CN 斜嘴钳

160 mm 180 mm CrV HRC 55-62



HALF DOUBLE BLISTER

YATO	L (mm)	
YT-6610	160	6/60
YT-6611	180	6/60

GB Diagonal side cutting pliers
D Seitenschneider
PL Szczypce tnące boczne
RUS Бокорезы
CZ Řezací kleště boční
H Oldal csipőfogó
RO Olește tăietor
F Pince à coupe latérale
I Pinze taglianti laterali
E Alicates corte lateral
CN 斜嘴钳



HALF DOUBLE BLISTER

YATO	L (mm)	
YT-6612	180	6/60

GB Combination pliers
D Kombinationszange
PL Szczypce uniwersalne
RUS Плоскогубцы универсальные
CZ Kleště kombinované
H Kombináltfogó

RO Patent universal
F Pince universelle
I Pinze universali
E Alicates universales
CN 钢丝钳

160 mm 200 mm HIGH LEVERAGE ZWIĘKSZONA SIŁA NACISKU



HALF DOUBLE BLISTER

YATO	L (mm)	
YT-6581	160	6/60
YT-6582	200	6/36

GB Diagonal side cutting pliers
D Seitenschneider
PL Szczypce tnące boczne
RUS Бокорезы
CZ Řezací kleště boční
H Oldal csipőfogó

RO Olește tăietor
F Pince à coupe latérale
I Pinze taglianti laterali
E Alicates corte lateral
CN 斜嘴钳

160 mm HIGH LEVERAGE ZWIĘKSZONA SIŁA NACISKU



HALF DOUBLE BLISTER

YATO	L (mm)	
YT-6583	160	6/60

GB Combination pliers
D Kombinationszange
PL Szczypce uniwersalne
RUS Плоскогубцы универсальные
CZ Kleště kombinované
H Kombináltfogó
RO Patent universal
F Pince universelle

I Pinze universali
E Alicates universales
CN 钢丝钳

115 mm
NICKEL IRON FINISH

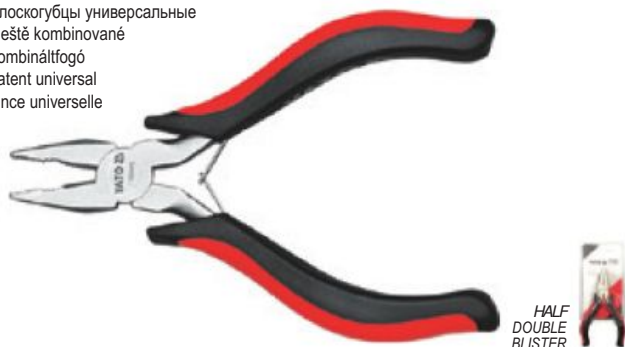

YATO L (mm)
YT-2080 115 6/120

HALF DOUBLE BLISTER

GB Diagonal side cutting pliers
D Seitenschneider
PL Szczypce tnące boczne
RUS Бокорезы
CZ Rezácí kleště boční
H Oldal csípőfogó
RO Olește tăietor
F Pince à coupe latérale

I Pinze taglianti laterali
E Alicates corte lateral
CN 斜嘴钳

115 mm
NICKEL IRON FINISH



YATO L (mm)
YT-2081 115 6/120

HALF DOUBLE BLISTER

GB Long nose pliers
D Radiozange
PL Szczypce wydłużone proste
RUS Тонкогубцы прямые
CZ Prodloužené kleště rovné
H Rádiófogó, egyenes

RO Clește cu vârf ascuțit
F Pince prolongée
I Pinze lunghe diritte
E Alicates de punta
CN 尖嘴钳

115 mm
NICKEL IRON FINISH



YATO L (mm)
YT-2083 115 6/120

HALF DOUBLE BLISTER

GB Bent nose pliers
D Telefonzange
PL Szczypce wydłużone wygięte
RUS Тонкогубцы изогнутые
CZ Prodloužené kleště ohnuté
H Rádió - és telefonfogó, hajlított

RO Clește cu vârf ascuțit îndoit
F Pince prolongée cambrée
I Pinze a punte mezzo tonde
E Alicates de punta curvos
CN 弯嘴钳

115 mm
NICKEL IRON FINISH



YATO L (mm)
YT-2084 115 6/120

HALF DOUBLE BLISTER

GB Flat nose pliers
D Elektrikerflachzange
PL Szczypce płaskie
RUS Утконосы
CZ Prodloužené kleště rovné
H Rádiófogó, egyenes

RO Clește cu vârf ascuțit
F Pince plate
I Pinze piatte
E Alicates de bocas planas
CN 平嘴钳

115 mm
NICKEL IRON FINISH



YATO L (mm)
YT-2085 115 6/120

HALF DOUBLE BLISTER

GB Round nose pliers
D Rundzange
PL Szczypce okrągłe
RUS Круглогубцы
CZ Kleště kulaté
H Kerekcsőrű fogó

RO Patent rotund
F Pince ronde
I Pinze tonde
E Alicates de punta redonda
CN 圆嘴钳

115 mm
NICKEL IRON FINISH



YATO L (mm)
YT-2086 115 6/120

HALF DOUBLE BLISTER

GB End cutting pliers
D Vornschnaider
PL Szczypce tnące czołowe
RUS Кусачки торцевые
CZ Kleště štípací čelní
H Homlokcsípő fogó
RO Clește retezat
F Coupe devant
I Pinza a taglio laterale
E Cortacables frontales
CN 顶切钳



YATO L (mm)
YT-2082 115 6/120

HALF DOUBLE BLISTER

GB Combination pliers
 D Kombinationszange
 PL Szczypce uniwersalne
 RUS Плоскогубцы универсальные
 CZ Kleště kombinované
 H Kombináltfogó
 RO Patent universal
 F Pince universelle
 I Pinze universali
 E Alicates universales
 CN 钢丝钳

160 mm 180 mm 200 mm CrV 1000 V DVE

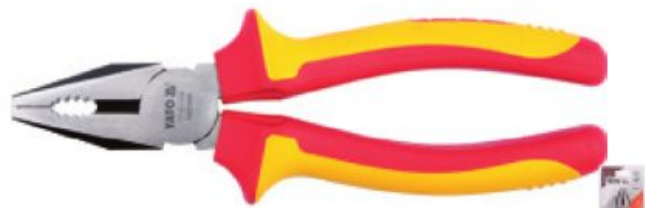

HALF DOUBLE BLISTER

YATO	L (mm)	
YT-21151	160	6/36
YT-21152	180	6/36
YT-21153	200	6/36

1000V
 VDE CERTIFICATE
 EN 60900:2012

GB Diagonal side cutting pliers
 D Seitenschneider
 PL Szczypce tnące boczne
 RUS Бокорезы
 CZ Řezací kleště boční
 H Oldal csípőfogó
 RO Olește tăietor
 F Pince à coupe latérale
 I Pinze taglianti laterali
 E Alicates corte lateral
 CN 斜嘴钳

160 mm 180 mm CrV 1000 V DVE



HALF DOUBLE BLISTER

YATO	L (mm)	
YT-21158	160	6/36
YT-21159	180	6/36

1000V
 VDE CERTIFICATE
 EN 60900:2012

GB Long nose pliers
 D Radiozange
 PL Szczypce wydłużone proste
 RUS Тонкогубцы прямые
 CZ Prodloužené kleště rovné
 H Rádiófogó, egyenes
 RO Clește cu vârf ascuțit
 F Pince prolongée
 I Pinze lunghe diritte
 E Alicates de punta
 CN 尖嘴钳

160 mm 200 mm CrV 1000 V DVE



HALF DOUBLE BLISTER

YATO	L (mm)	
YT-21154	160	6/36
YT-21155	200	6/36

1000V
 VDE CERTIFICATE
 EN 60900:2012

GB Wire stripping pliers
 D Abisolierzange
 PL Szczypce do ściągania izolacji
 RUS Пасатижи для зачистки проводов
 CZ Kleště odizolovací na drát
 H Blankoló fogó
 RO Decablator
 F Pince à l'isolation
 I Pinze spelafili
 E Pinzas pelacables
 CN 剥线钳

160 mm CrV 1000 V DVE



HALF DOUBLE BLISTER

YATO	L (mm)	
YT-21160	160	6/36

1000V
 VDE CERTIFICATE
 EN 60900:2012

GB Water pump pliers
 D Wasserpumpenzange
 PL Szczypce nastawne
 RUS Клещи переставные
 CZ Keleště siko
 H Vízpumpafogó
 RO Clește papagal

F Pince réglable
 I Pinze regolabili
 E Alicates de fontanero ajustables
 CN 水泵钳

250 mm CrV 1000 V DVE



HALF DOUBLE BLISTER

YATO	L (mm)	
YT-21161	250	6/24

1000V
 VDE CERTIFICATE
 EN 60900:2012

GB Insulated flat nose pliers
 D Sicherheitsklammer mit Haken
 PL Szczypce płaskie izolowane
 RUS Клещи для замены предохранителей
 CZ Izolované kleště s plochými čelistmi
 H Rugós szorító
 RO Patent izolat
 F Pince plate isolée
 I Pinze plate plastica isolati
 E Alicates punta plana aislantes
 CN 绝缘平嘴钳

200 mm CrV 1000 V DVE



POLYBAG

YATO	L (mm)	
YT-21191	200	6/48

1000V
 VDE CERTIFICATE
 EN 60900:2012

GB Diagonal side cutting pliers
D Seitenschneider
PL Szczypce tnące boczne
RUS Бокорезы
CZ Řezací kleště boční
H Oldal csípőfogó

RO Olește tăietor
F Pince à coupe latérale
I Pinze taglianti laterali
E Alicates corte lateral
CN 斜嘴钳

125 mm CrV 60
HRC CUTTER 56-62 HRC BODY 43-48
FOR PLASTIC max. ∅ 3 mm



SLIDING CARD

YATO L (mm) 6/120
YT-1950 125 6/120

GB Diagonal side cutting pliers
D Seitenschneider
PL Szczypce tnące boczne
RUS Бокорезы
CZ Řezací kleště boční
H Oldal csípőfogó

RO Olește tăietor
F Pince à coupe latérale
I Pinze taglianti laterali
E Alicates corte lateral
CN 斜嘴钳

150 mm CrV 60
HRC CUTTER 56-62 HRC BODY 43-48
FOR PLASTIC max. ∅ 5 mm



SLIDING CARD

YATO L (mm) 6/120
YT-1951 150 6/120

GB Diagonal side cutting pliers
D Seitenschneider
PL Szczypce tnące boczne
RUS Бокорезы
CZ Řezací kleště boční
H Oldal csípőfogó

RO Olește tăietor
F Pince à coupe latérale
I Pinze taglianti laterali
E Alicates corte lateral
CN 斜嘴钳

180 mm CrV 60
HRC CUTTER 56-62 HRC BODY 43-48
FOR PLASTIC max. ∅ 6 mm



SLIDING CARD

YATO L (mm) 6/60
YT-1952 180 6/60

GB Diagonal side cutting pliers
D Seitenschneider
PL Szczypce tnące boczne
RUS Бокорезы
CZ Řezací kleště boční
H Oldal csípőfogó

RO Olește tăietor
F Pince à coupe latérale
I Pinze taglianti laterali
E Alicates corte lateral
CN 斜嘴钳

100 mm CrV 60
HRC CUTTER 56-62 HRC BODY 43-48
FOR CABLE CUTTING max. ∅ 1.0mm
COPPER max. ∅ 1.8mm



SLIDING CARD

YATO L (mm) 6/120
YT-1953 100 6/120

GB Diagonal side cutting pliers
D Seitenschneider
PL Szczypce tnące boczne
RUS Бокорезы
CZ Řezací kleště boční
H Oldal csípőfogó

RO Olește tăietor
F Pince à coupe latérale
I Pinze taglianti laterali
E Alicates corte lateral
CN 斜嘴钳

125 mm CrV 60
HRC CUTTER 56-62 HRC BODY 43-48
FOR CABLE CUTTING max. ∅ 1.2mm
COPPER max. ∅ 2.0mm



SLIDING CARD

YATO L (mm) 6/120
YT-1954 125 6/120

GB Long nose pliers
D Radiozange
PL Szczypce wydłużone proste
RUS Тонкогубцы прямые
CZ Prodloužené kleště rovné
H Rádiófogó, egyenes

RO Clește cu vârf ascuțit
F Pince prolongée
I Pinze lunghe diritte
E Alicates de punta
CN 尖嘴钳

150 mm CrV 60
HRC CUTTER 56-62 HRC BODY 43-48
STEEL max. ∅ 1.5mm
COPPER max. ∅ 2.6mm



SLIDING CARD

YATO L (mm) 6/120
YT-1956 150 6/120

GB Carpenter's pliers
D Kneifzange
PL Obcegi
RUS Клещи строительные

CZ Kleště
H Harapófógó
RO Cleste cuie
F Tenailles

I Tenaglie
E Tenazas
CN 胡桃钳

160 mm 180 mm 200 mm DIN 5748 NICKEL IRON FINISH



HALF DOUBLE BLISTER



YATO	L (mm)	
YT-2046	160	6/60
YT-2047	180	6/60
YT-2048	200	6/60

GB Tower pincers
D Beisszange
PL Obcegi tynkarskie
RUS Клещи штукатурные

CZ Kleště štípací čelní
H Rabitzfógó
RO Cleste pt. cuie
F Tenaille russe

I Tenaglie tronchesi
E Tenazas de enlucido
CN 扎线钳

200 mm 250 mm 275 mm DIN 5748 NICKEL IRON FINISH



HALF DOUBLE BLISTER



YATO	L (mm)	
YT-2058	200	6/60
YT-2060	250	6/36
YT-2061	275	6/36

GB Tower pincers
D Beisszange
PL Obcegi tynkarskie
RUS Клещи штукатурные

CZ Kleště štípací čelní
H Rabitzfógó
RO Cleste pt. cuie
F Tenaille russe

I Tenaglie tronchesi
E Tenazas de enlucido
CN 扎线钳

250 mm HRC 44-50 BODY HRC 58-62 CUTTER CrV 55 DIN 5746



HALF DOUBLE BLISTER



YATO	L (mm)	
YT-1949	250	6/36

GB Heavy duty side cutting pliers
D Seitenschneider, Schwer Typ
PL Szczypce tnące boczne
RUS Бокорезы усиленные
CZ Řezací kleště boční

H Oldal csípófógó
RO Olește tăietor
F Pince à coupe latérale
I Pinze taglianti laterali

E Alicates de corte lateral tipo pesado
CN 重型斜口钳

180 mm DIN 5749 NICKEL IRON FINISH



HALF DOUBLE BLISTER



YATO	L (mm)	
YT-2039	180	6/60

GB Carpenter's pliers
D Kneifzange
PL Obcegi
RUS Клещи строительные

CZ Kleště
H Harapófógó
RO Cleste cuie
F Tenailles

I Tenaglie
E Tenazas
CN 胡桃钳

150 mm 175 mm 200 mm CrV 50 HRC 55-60 HEAD GEOMETRIA



SLIDING CARD



YATO	L (mm)	cold rolled steel (mm) stal walcowana na zimno (mm)	
YT-2050	150	1.5	6/60
YT-2051	175	1.8	6/60
YT-2052	200	2.0	6/48

GB Tower pincers
D Beisszange
PL Obcegi tynkarskie
RUS Клещи штукатурные

CZ Kleště štípací čelní
H Rabitzfógó
RO Cleste pt. cuie
F Tenaille russe

I Tenaglie tronchesi
E Tenazas de enlucido
CN 扎线钳

225 mm 250 mm 275 mm CrV 50 HRC 55-62 HEAD GEOMETRIA



SLIDING CARD



YATO	L (mm)	cold rolled steel (mm) stal walcowana na zimno (mm)	
YT-2055	225	1.8	6/60
YT-2056	250	2.0	6/48
YT-2057	275	2.2	6/24

GB End cutting pliers
D Vornschneider
PL Szczypce tnące czołowe

RUS Кусачки торцевые
CZ Kleště štípací čelní
H Homlokcsípó fogó

RO Cleste retezat
F Coupe devant
I Pinza a taglio laterale

E Cortacables frontales
CN 顶切钳

150 mm 175 mm 200 mm CrV 50 HRC 55-60 HEAD GEOMETRIA



SLIDING CARD











YATO	L (mm)	cold rolled steel (mm) stal walcowana na zimno (mm)	
YT-2063	175	1.5	6/48
YT-2064	200	1.8	6/48

- GB Circlip pliers
D Seegeringgzange
PL Szczypce Segera
RUS Съёмник стопорных колец
CZ Kleště Segera
H Segerfogó belseő
RO Clește Seger
- F Pince pour anneau de retenue seeger
I Pinze Seger
E Alicates Seger
CN 5件套卡簧钳

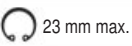
5 PCS 160 mm \varnothing mm 10-50

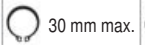

		23 mm max.		20 mm max.
		28 mm max.		23 mm max.
		30 mm max.		27 mm max.



YATO	L (mm)	
YT-2130	160	20/60

- GB Circlip pliers
D Seegeringgzange
PL Szczypce Segera
RUS Съёмник стопорных колец
CZ Kleště Segera
H Segerfogó belseő
- RO Clește Seger
F Pince pour anneau de retenue seeger
I Pinze Seger
E Alicates Seger
CN 直嘴轴用挡圈钳

SLIDING CARD



180 mm HRC 42-48 CrV 50



YATO	L (mm)	
YT-2136	180	6/24

YATO	L (mm)	
YT-2138	180	6/24



YATO	L (mm)	
YT-2137	180	6/24

YATO	L (mm)	
YT-2139	180	6/24

GB Circlip pliers
 D Seegeringgzange
 PL Szczypce Segera
 RUS Съёмник стопорных колец
 CZ Kleště Segera
 H Segerfogó belső
 RO Clește Seger
 F Pince pour anneau de retenue seeger
 I Pinze Seger
 E Alicates Seger
 CN 直嘴轴用挡圈钳

SLIDING CARD



150 mm
 200 mm
 CrV
 NICKEL IRON FINISH



YATO	L (mm)	
YT-2140	150	6/120
YT-2144	200	6/60



YATO	L (mm)	
YT-2141	150	6/120
YT-2145	200	6/60



YATO	L (mm)	
YT-2142	150	6/60
YT-2146	200	6/60



YATO	L (mm)	
YT-2143	150	6/120
YT-2147	200	6/60

GB Circlip pliers
 D Seegeringgzange
 PL Szczypce Segera
 RUS Съёмник стопорных колец
 CZ Kleště Segera
 H Segerfogó belső
 RO Clește Seger
 F Pince pour anneau de retenue seeger
 I Pinze Seger
 E Alicates Seger
 CN 直嘴轴用挡圈钳

SLIDING CARD



225 mm
 325 mm
 NICKEL FINISH
 CrV



YATO	L (mm)	
YT-1988	225	6/60
YT-1992	325	6/48



YATO	L (mm)	
YT-1989	225	6/60
YT-1993	325	6/48



YATO	L (mm)	
YT-1990	225	6/60
YT-1994	325	6/48



YATO	L (mm)	
YT-1991	225	6/60
YT-1995	325	6/48

GB Lock grip pliers
D Gripzange
PL Szczypce Morse'a
RUS Зажим ручной
CZ Kleště Morse'a
H Morse fogó

RO Clește Morse
F Pincés de serrage Morse
I Pinze Morse
E Alicates Morse
CN 圆口大力钳

HALF
DOUBLE
BLISTER



CrV



140 mm
240 mm
180 mm
WR TYPE



165 mm
220 mm
CD TYPE

YATO	L (mm)	
YT-2151	140	6/48
YT-2152	180	6/36
YT-2153	240	6/36

YATO	L (mm)	
YT-2155	165	6/48
YT-2156	220	6/36

GB Locking pliers
D Klemmzange
PL Szczypce zaciskowe
RUS Клещи давяльные
CZ Kleště samosvorné
H Patentfogó
RO Clește de strângere

F Pincés de serrage Morse
I Pinze Morse
E Pinzas de tornillo
(de apriete)
CN 圆口大力钳

HALF
DOUBLE
BLISTER



CrMo

250 mm



YATO	L (mm)	
YT-2453	250	6/24

125 mm



YATO	L (mm)	
YT-2449	125	6/24

180 mm



YATO	L (mm)	
YT-2450	180	6/24

150 mm



YATO	L (mm)	
YT-2459	150	6/24

250 mm



YATO	L (mm)	
YT-2451	250	6/24

225 mm



YATO	L (mm)	
YT-2460	225	6/24

180 mm



YATO	L (mm)	
YT-2452	180	6/24

GB Locking pliers
D Klemmzange
PL Szczypce zaciskowe
RUS Клещи давяльные
CZ Kleště samosvorné

H Patentfogó
RO Clește de strângere
F Pince de serrage courte
avec blocage
I Pinze di bloccaggio
E Pinzas
de tornillo (de apriete)
CN 大力钳

HALF
DOUBLE
BLISTER



250 mm

0-42 mm

CrMo



YATO	L (mm)	
YT-2473	250	6/24



YATO	L (mm)	
YT-2476	250	6/24

- GB Sliding arm welding locking pliers
- D Parallel-gripzange
- PL Szybkonastawne szczypce spawalnicze
- RUS Образная струбцина с захватом
- CZ Paralelné samosvorné kleště
- H Szorítórúdas önzáró fogó
- RO Clește de mana cu prindere tip menghina
- F Pince-étou - serre-joint coulissant
- I Scorrevole pinze di bloccaggio di saldatura braccio
- E Pinzas de presión tipo sargento
- CN C型滑杆大力钳

260 mm **0-150 mm**
QUICK-ADJUSTMENT
SZBYKONASTAWNY



YATO	L (mm)	
YT-21570	260	2/16

HALF DOUBLE BLISTER



- GB Welding locking pliers
- D Klemmzange zum Schweißen
- PL Szczypce zaciskowe spawalnicze
- RUS Клещи давяльные сварочные
- CZ Kleště samosvorné svářečské
- H Hegesztő fogó
- RO Clește de strângere pt. sudură
- F Pincés de serrage pour soudeur
- I Pinze di bloccaggio per saldatura
- E Pinzas de tornillo (de apriete) para soldar
- CN 焊接用大力钳



HALF DOUBLE BLISTER **225 mm**
TYPE U
0-85 mm
70 mm



YATO	L (mm)	
YT-2461	225	6/24

- GB Flat locking pliers
- D Klemmzange mit breiten Backen
- PL Szczypce zaciskowe o szerokich szczękach
- RUS Клещи давяльные с широкими губками
- CZ Kleště samosvorné se širokými čelistmi
- H Lapos fogó
- RO Clește de strângere plat / patent
- F Pince de serrage large
- I Pinze con ganasce piane e palette
- E Pinzas de tornillo (de apriete) con mordazas anchas
- CN 铁皮大力钳



HALF DOUBLE BLISTER **200 mm**
0-50 mm
75 mm



YATO	L (mm)	
YT-2463	200	6/24

- GB C-type welding locking pliers
- D Klemm- und Klammerzange vom Typ „C“
- PL Szczypce zaciskowe klamrowe typu „C“
- RUS Клещи давяльные типа „С“
- CZ Kleště samosvorné upínací typu „C“
- H „C“ fogó

- RO Clește de strângere cu clemă tip „C“
- F Pince de serrage type „C“
- I Pinze di bloccaggio tipo „C“
- E Pinzas de tornillo (de apriete) de grapa tipo „C“
- CN C型大力钳

HALF DOUBLE BLISTER



280 mm
TYPE C

0-100 mm



YATO	L (mm)	
YT-2466	280	6/24

0-80 mm



YATO	L (mm)	
YT-2468	280	6/24

- GB Chain locking pliers
- D Klemmzange mit Kette
- PL Szczypce zaciskowe z łańcuchem
- RUS Клещи давяльные с цепью
- CZ Kleště samosvorné s řetězem
- H Láncos csőfogó
- RO Clește de strângere cu lanț
- F Pince de serrage avec une chaîne
- I Pinze di bloccaggio con la catena
- E Pinzas de tornillo (de apriete) con cadena
- CN 链条大力钳

HALF DOUBLE BLISTER



500 mm
40 Mn



YATO	L (mm)	
YT-2469	500	6/24

GB Self-locking multi grip pliers
D Grip-Festhaltezange
PL Szczypce blacharskie
RUS Зажим ручной сварочный для закрепления лент и профилей
CZ Kleště klempířské samodržící
H Őnzáró rögzítőfogó

RO Cleste autoblocant pt. tinichigerie
F Pince pour tôle
I Pinze per lamiera
E Pinzas de chapa
CN 多功能大力钳

SLIDING CARD
CrMo



YATO	L (mm)	
YT-2160	200	12/24



YATO	L (mm)	
YT-2161	230	12/24



YATO	L (mm)	
YT-2162	215	12/36

GB Profile connection pliers
D Zange zum Verbinden der Profile
PL Szczypce do łączenia profili
RUS Щипцы для соединения профилей
CZ Kleště ke spojování profilů
H Profilgyesítő fogó

RO Cleste pt. îmbinarea profilelor
F Pince pour sertir les profiles
I Pinze per la unione profili
E Pinzas para conectar perfiles
CN 龙骨钳

SLIDING CARD
SECTION THICKNESS GRUBOSC PROFILU 0.5-0.8 mm



YATO	L (mm)	
YT-5130	275	6/24



YATO	L (mm)	
YT-5131	345	6/24

GB Profile connection pliers
D Zange zum Verbinden der Profile
PL Szczypce do łączenia profili
RUS Щипцы для соединения профилей
CZ Kleště ke spojování profilů
H Profilgyesítő fogó
RO Cleste pt. îmbinarea profilelor

F Pince pour sertir les profiles
I Pinze per la unione profili
E Pinzas para conectar perfiles
CN 新款长柄龙骨钳

280 mm
SECTION THICKNESS GRUBOSC PROFILU 0.5-0.8 mm

GR15 BEARING STEEL (PUNCH)

A380 Al-Ti ALLOY (HEAD)

SLIDING CARD



YATO	L (mm)	
YT-5131	280	6/24

GB Punch pliers
D Blech Lochzange
PL Szczypce do dziurkowania blach
RUS Просекатель круглых отверстий
CZ Děrovací kleště
H Fogó peremező lyukasztó

RO Cleste pt. perforat
F Trou pince feuilles
I Pinza per forare lamiera
E Punzonadora una mano perfiles
CN CS打孔钳

240 mm
PUNCH DIAMETER ŚREDNICA OTWORU Ø 3.2 mm

GR15 BEARING STEEL (PUNCH)

SLIDING CARD



YATO	L (mm)	
YT-5132	240	5/30

GB Profile forming pliers
D Zange zur Formgebung der Profile
PL Szczypce do kształtowania profili
RUS Щипцы для формировки профилей
CZ Kleště k tvarování profilů

H Profilformázó fogó
RO Cleste pt. modelarea profilelor
F Pince pour former les profiles
I Pinze per la formazione di profili
E Pinzas para formar perfiles
CN 龙骨钳

210 mm
SLIDING CARD



YATO	L (mm)	
YT-5140	210	2/12



YATO	L (mm)	
YT-5141	210	2/12



YATO	L (mm)	
YT-5142	210	2/12

GB Water pump pliers
D Wasserpumpenzange
PL Szczypce nastawne
RUS Клещи переставные
CZ Keleště siko
H Vízpumpafágó

RO Cleste papagal
F Pince réglable
I Pinze regolabili
E Alicates de fontanero ajustables
CN 水泵钳

250 mm 300 mm CrV

WIDEN RANGE ADJUSTMENT REGULACJA ZAKRESU PRACY

STRENGTHENED JAWS REINFORCENIA KONSTRUKCJA



YATO	L (mm)	
YT-2090	250	6/36
YT-2091	300	6/36

GB Water pump pliers
D Wasserpumpenzange
PL Szczypce nastawne
RUS Клещи переставные
CZ Keleště siko
H Vízpumpafágó

RO Cleste papagal
F Pince réglable
I Pinze regolabili
E Alicates de fontanero ajustables
CN 水泵钳

250 mm NICKEL IRON FINISH

HALF DOUBLE BLISTER



YATO	L (mm)	
YT-2069	250	6/36

6

GB Water pump pliers
D Wasserpumpenzange
PL Szczypce nastawne
RUS Клещи переставные
CZ Keleště siko
H Vízpumpafágó

RO Cleste papagal
F Pince réglable
I Pinze regolabili
E Alicates de fontanero ajustables
CN 水泵钳

250 mm JAW WIDTH SZEROKOSC SZCZEK 6 mm CrV

WIDEN RANGE ADJUSTMENT REGULACJA ZAKRESU PRACY

STRENGTHENED JAWS REINFORCENIA KONSTRUKCJA



YATO	L (mm)	
YT-20911	250	10/50

GB Water pump pliers
D Wasserpumpenzange
PL Szczypce nastawne
RUS Клещи переставные
CZ Keleště siko
H Vízpumpafágó

RO Cleste papagal
F Pince réglable
I Pinze regolabili
E Alicates de fontanero ajustables
CN 水泵钳

250 mm NICKEL IRON FINISH

HALF DOUBLE BLISTER



YATO	L (mm)	
YT-2070	250	6/24

GB Pipe wrench
D Rohrschlüssel
PL Klucz do rur
RUS Ключ трубный

CZ Klíč součásti na trubky
H Csőkulcs
RO Cheie reglabila pt. tevi

F Clé aux tubes
I Chiave per tubi
E Llave para tubos
CN 铝合金管钳

CrMo

HRC 55-60

AL HANDLE UCHWYT



YATO	size / rozmiar	max. pipe diameter / max. średnica rury	
YT-2482	14" (350 mm)	2" (50 mm)	6/12
YT-2483	18" (450 mm)	2.5" (63 mm)	2/10
YT-2484	24" (600 mm)	3" (75 mm)	2/6
YT-2485	36" (900 mm)	5" (125 mm)	3

GB Pipe wrench
D Rohrschlüssel
PL Klucz do rur
RUS Ключ трубный

CZ Klíč součásti na trubky
H Csőkulcs
RO Cheie reglabila pt. tevi

F Clé aux tubes
I Chiave per tubi
E Llave para tubos
CN 铝合金管钳

HRC 55-60

AL HANDLE UCHWYT



YATO	size / rozmiar	max. pipe diameter / max. średnica rury	
YT-2222	12" (300 mm)	1" (25 mm)	6/24
YT-2223	14" (350 mm)	1.5" (38 mm)	4/16
YT-2224	18" (450 mm)	2" (50 mm)	3/12
YT-2225	24" (600 mm)	2.5" (63 mm)	3/6

GB Pipe wrench
D Rohrschlüssel
PL Klucz do rur
RUS Ключ трубный

CZ Klíč součásti na trubky
H Csőkulcs
RO Cheie reglabila pt. tevi

F Clé aux tubes
I Chiave per tubi
E Llave para tubos
CN 铝合金管钳

CrMo

HRC 55-60



YATO	size / rozmiar	max. pipe diameter / max. średnica rury	
YT-2488	10" (250 mm)	1" (25 mm)	6/18
YT-2489	12" (300 mm)	1.5" (38 mm)	6/12
YT-2490	14" (350 mm)	2" (50 mm)	2/10
YT-2491	18" (450 mm)	2.5" (63 mm)	3/6
YT-2492	24" (600 mm)	3" (75 mm)	2/4
YT-2493	36" (900 mm)	5" (125 mm)	1
YT-2494	48" (1200 mm)	6" (150 mm)	1

GB Pipe wrench
D Rohrschlüssel
PL Klucz do rur
RUS Ключ трубный

CZ Klíč součásti na trubky
H Csőkulcs
RO Cheie reglabila pt. tevi

F Clé aux tubes
I Chiave per tubi
E Llave para tubos
CN 铝合金管钳

HRC 55-60

OFFSET TYPE ODGIETA GLOWICA



YATO	size / rozmiar	max. pipe diameter / max. średnica rury	
YT-2201	10" (250 mm)	1" (25 mm)	6/36
YT-2203	14" (350 mm)	1.5" (38 mm)	4/16
YT-2204	18" (450 mm)	2" (50 mm)	3/12
YT-2205	24" (600 mm)	2.5" (63 mm)	3/6
YT-2206	36" (900 mm)	4" (100 mm)	2/4

- GB Auto-adjustable pipe wrench
D Rollgabelschlüssel
PL Szybkonastawny klucz do rur
RUS Ключ разводной
CZ Nastavitelný klíč
H Állítható svédkulcs
- RO Cheie reglabilă
F Clé à molette
I Chiave autoregolabile per tubi
E Llave ajustable
CN 可調式管鉗

16-38 mm
5/8"-1 1/2"
300 mm
SELF-ADJUSTING SAMO-NASTAWNY
QUICK RELEASE SZYBKIE OTWIERANE
HRC 46-52
HARDENED JAWS HARTOWANE SZCZĘKI

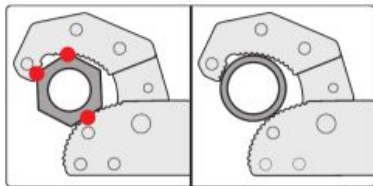

HALF DOUBLE BLISTER

YATO	L (mm)	
YT-22005	300	6/24

- GB Strap wrench
D Bandschlüssel
PL Klucz taśmowy do rur
RUS Стречковый ключ
CZ Klíč s popruhem
H Csőfogó
- RO Cheie cu chinga
F Clé a sangle sanitaire
I Chiave a nastro per tubi
E Llave de correa
CN 皮帶管鉗

300 mm
12"
200 mm
8"
STRAP SIZE WIDEL PASKA 825 x 28 mm
NYLON
AI

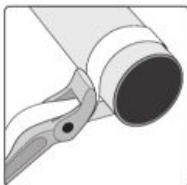

- for:
• chromed pipes
• PVC pipes
• oil filters
- do:
• rur chromowanych
• rur PCV
• filtrów oleju



SLIDING CARD

YATO	L (mm)	max. pipe diameter / max. średnica rury	
YT-22255	300	8" (200 mm)	5/50

- GB Chain pipe wrench
D Kettenrohrzange
PL Klucz łańcuchowy do rur
- RUS Ключ цепной для труб
CZ Klíč řetězový na trubky
H Láncos csőfogó
- RO Cheie reglabilă pt. tevi cu lant
F Clé à chaîne
- I Chiave a catena per tubi
E Llave de cadena
CN 链条管子鉗

SLIDING CARD
4"
100 mm
300 mm
INDUCTION HARDENED TEETH
BEST HARTOVANÉ TOČKOVANÉ
ANTI-MAGNETIC
ANTIACID
KWAŚCO-ODPORNA



YATO	L (mm)	max. pipe diameter / max. średnica rury	
YT-22260	300	4" (100 mm)	6/24

- GB Tweezer
D Pinzette
PL Pęseta
RUS Пинцет
- CZ Pinzeta
H Csipesz
RO Pensetă
F Pince
- I Pinza
E Pinzas
CN 镊子

SLIDING CARD
302
STAINLESS STEEL
STAL NIEŻYRDZĄCA
ANTI-MAGNETIC
ANTIACID
KWAŚCO-ODPORNA



140 mm
HRC 30

YATO	L (mm)	
YT-6903	140	20/240



115 mm
HRC 30

YATO	L (mm)	
YT-6907	115	20/240



140 mm
HRC 40

YATO	L (mm)	
YT-6916	140	20/240

- GB Pipe wrench - german type
D Rohrschlüssel - deutsch type
PL Klucz do rur - typ niemiecki
RUS Трубный ключ - немецкий тип
CZ Nastavitelný klíč na trubky - němčina typ
- H Állítható csőkulcs - német típusú
RO Cheie reglabilă pt. tevi - tip german
F Clé serre-tube type allemand
I Chiave per tubi - tipo tedesco
E Llave para tubos tipo alemán
CN 德式管子鉗

HRC 47-53
HARDENED JAWS HARTOVANE SZCZĘKI



COLOR BOX

YATO	L (mm)	max. opening capacity / max. zakres rozwarcia szczęk (mm)	max. pipe diameter / max. średnica rury (mm)	
YT-22000	7" (175 mm)	45	20	6/60
YT-22001	9" (225 mm)	60	30	6/36
YT-22002	10.5" (275 mm)	70	35	6/24

- GB Strap for pipe wrench
D Gurt für Bandschlüssel
PL Taśma zapasowa do klucza do rur
RUS Ремень для ремешковых ключи
CZ Popruh pro klíč olejových filtrů
- H Szíjas az szíjas csőfogó
RO Chinga la chei cu chingă
F Courroie pour clés a courroie
I Nastro di ricambio per chiave per tubi
E Correa a llaves de correa
CN 皮帶管鉗配件

200 mm
8"
STRAP SIZE WIDEL PASKA 825 x 28 mm
NYLON



for / dla: YT-22255

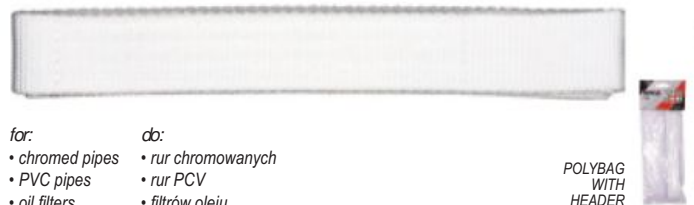

- for:
• chromed pipes
• PVC pipes
• oil filters
- do:
• rur chromowanych
• rur PCV
• filtrów oleju























POLYBAG WITH HEADER

YATO		
YT-22256		50

7

Electrician tools Narzędzia dla elektryków



Insulated screwdrivers Wkrętaki izolowane	110		Insulated hex keys Klucze imbusowe izolowane	114	
Insulated slotted screwdrivers Wkrętaki izolowane płaskie	110		Insulated clamps Ściski izolowane	114	
Insulated phillips screwdrivers Wkrętaki izolowane krzyżakowe	110		Crimping pliers & sets Szcypce do zaciskania konektorów i zestawy	114-116	
Insulated Pozidrive screwdrivers Wkrętaki izolowane „Pozidrive”	110		Hydraulic pliers Ręczne praski hydrauliczne	117	
Insulated screwdriver sets Komplety wkrętek izolowanych	110		Wire strippers Ściągacze izolacji	117-119	
Insulated pliers Szcypce izolowane	111		Electrical cutters Obcinaki elektryczne	119-120	
Combination pliers Szcypce uniwersalne	111		Cable cutters Nożyce do kabli	120-121	
Side cutting pliers Szcypce tnące, boczne	111		Electric meters & voltage testers Mierniki elektryczne i próbniki napięcia	122	
Long nose pliers Szcypce wydłużone, proste	111		Multimeters Mierniki	123-124	
Wire stripping pliers Szcypce do ściągania izolacji	111		Glue guns Pistolety do klejenia	125	
Water pump pliers Szcypce nastawne	111		Soldering tools & accessories Lutownice i akcesoria	125-126	
Insulated flat nose pliers Klucze płaskie izolowane	111		Tweezers Pęsety	126	
Insulated ring & open end wrenches Klucze oczkowe i płaskie izolowane	112		Electrical insulation tapes & sets Taśmy elektroizolacyjne i zestawy	126	
Insulated ring wrenches Klucze oczkowe izolowane	112		Tool sets Zestawy narzędziowe	127	
Insulated open end wrenches Klucze płaskie izolowane	112		Workshop standardized parts Normalia motoryzacyjne	127-128	
Insulated T-handle wrenches Rękojeści typu „T” z zabierakiem izolowane	112				
Insulated adjustable wrenches Klucze nastawne izolowane	112				
Insulated sockets & accessories Klucze nasadowe izolowane i akcesoria	113				
Insulated hexagonal sockets 3/8” Klucze nasadowe sześciokątne izolowane, krótkie 3/8”	113				
Insulated extension bars 3/8” Przedłużki izolowane 3/8”	113				
Insulated ratchet handles 3/8” Grzechotki izolowane 3/8”	113				
Insulated hexagonal sockets 1/2” Klucze nasadowe sześciokątne izolowane, krótkie 1/2”	113				
Insulated extension bars 1/2” Przedłużki izolowane 1/2”	113				
Insulated ratchet handles 1/2” Grzechotki izolowane 1/2”	113				
Insulated bit sockets 3/8”, 1/2” Klucze trzpieniowe izolowane 3/8”, 1/2”	114				

GB Insulated screwdriver
D Isolierte Schraubendreher
PL Wkrętak izolowany
RUS Изолированная отвёртка
CZ Izolovaný šroubovák
H Szigetelt csavarhúzó

RO Şurubelniţă izolată
F Tournevis isolé
I Cacciavite isolato
E Destornillador aislado
CN 绝缘螺丝批



PLASTIC HANGER

- application: industry
- VDE certificate
- przeznaczenie: przemysł
- certyfikat VDE



YATO	⊖	L (mm)	
YT-2815	3.0	75	12/120
YT-2816	4.0	75	12/120
YT-2817	4.0	100	12/120
YT-2818	5.5	125	12/120
YT-2819	6.5	150	12/120
YT-2820	8.0	175	12/120



YATO	⊕	L (mm)	
YT-2821	PH0	60	12/120
YT-2822	PH1	80	12/120
YT-2823	PH2	100	12/120
YT-2824	PH3	150	12/120



YATO	⊕	L (mm)	
YT-2825	PZ1	80	12/120
YT-2826	PZ2	100	12/120

7

GB Insulated screwdriver set
D Isolierte Schraubendrehersatz
PL Komplet wkrętaków izolowanych
RUS Изолированная отвёртка - набор

CZ Izolované šroubováky
H Szigetelt csavarhúzó
RO Şurubelniţă izolată
F Set de tournevis isolés

I Set di cacciavite isolato
E Juego de destornilladores aislado
CN 绝缘螺丝批组套

- application: industry
- VDE certificate
- przeznaczenie: przemysł
- certyfikat VDE

DOUBLE BLISTER



YATO	⊖	⊕	L (mm)	
YT-2827	3.0		100	10/40
	4.0		100	
	5.5		125	
		PH1	80	
		PH2	100	

YATO	⊖	⊕	⊕	L (mm)	
YT-2828	3.0			100	10/40
	4.0			100	
	5.5			125	
		PH1		80	
		PH2		100	
			PZ1	80	
			PZ2	100	
				100	

GB Insulated changeable screwdriver set
D Schraubendreher Satz isoliert
PL Zestaw wkrętaków z wymiennymi końcówkami izolowanymi

RUS Набор изолированных отверток
CZ Sada izolovaného nářadí
H Csavarhúzó kétvégű szárral
RO Set surubelnita cu biti, izolate

F Jeu d'outils isolés
I Set di cacciavite isolato
E Juego de destornilladores aislado
CN 绝缘螺丝批组套

1000V VDE CERTIFICATE EN 60900:2012

NYLON CASE & POLYBAG



⊖ 2.0, 2.5, 3.0, 3.5, 4.0, 5.5, 6.5 (L=100 mm); S2;
⊕ PH0, PH1, PH2 (L=100 mm); S2;
4x150 mm; 250V

⊖ 2.0, 2.5, 3.0, 3.5, 4.0, 5.5, 6.5 (L=100 mm); S2;
⊕ PH0, PH1, PH2 (L=100 mm); S2;
⊕ PZ0, PZ1, PZ2 (L=100 mm); S2;
⊖ T6, T8, T9, T10, T15, T20, T25, T27, T30 (L=100 mm); S2;
⊖ 2, 3, 4, 5, 6 (L=100 mm); S2;
⊖ R1, R2 (L=100 mm); S2;
⊖ 1, 2, 3, 4 (L=100 mm); S2;
⊖ 4, 6, 8, 10 (L=100 mm); S2;
⊖ 4, 6, 8, 10 (L=100 mm); S2;
⊖ M4, M5, M6 (L=100 mm); S2;
4x150 mm; 250V



YATO		
YT-28290		24



YATO		
YT-28293		10

GB Combination pliers
D Kombinationszange
PL Szczypce uniwersalne
RUS Плоскогубцы универсальные
CZ Kleště kombinované
H Kombináltfogó
RO Patent universal
F Pince universelle
I Pinze universali
E Alicates universales
CN 钢丝钳

160 mm 180 mm 200 mm CrV 1000 V DVE



HALF
DOUBLE
BLISTER

YATO	L (mm)	
YT-21151	160	6/36
YT-21152	180	6/36
YT-21153	200	6/36

1000V
VDE CERTIFICATE
EN 60900:2012

GB Diagonal side cutting pliers
D Seitenschneider
PL Szczypce tnące boczne
RUS Бокорезы
CZ Rezáci kleště boční
H Oldal csípőfogó
RO Olește tăietor
F Pince à coupe latérale
I Pinze taglianti laterali
E Alicates corte lateral
CN 斜嘴钳

160 mm 180 mm CrV 1000 V DVE



HALF
DOUBLE
BLISTER

YATO	L (mm)	
YT-21158	160	6/36
YT-21159	180	6/36

1000V
VDE CERTIFICATE
EN 60900:2012

GB Long nose pliers
D Radiozange
PL Szczypce wydłużone proste
RUS Тонкогубцы прямые
CZ Prodloužené kleště rovné
H Rádiófogó, egyenes
RO Clește cu vârf ascuțit
F Pince prolongée
I Pinze lunghe diritte
E Alicates de punta
CN 尖嘴钳

160 mm 200 mm CrV 1000 V DVE



HALF
DOUBLE
BLISTER

YATO	L (mm)	
YT-21154	160	6/36
YT-21155	200	6/36

1000V
VDE CERTIFICATE
EN 60900:2012

GB Wire stripping pliers
D Abisolierzange
PL Szczypce do ściągania izolacji
RUS Пасатижи для зачистки проводов
CZ Kleště odizolovací na drát
H Blankoló fogó
RO Decablator
F Pince à l'isolation
I Pinze spelafili
E Pinzas pelacables
CN 剥线钳

160 mm CrV 1000 V DVE



HALF
DOUBLE
BLISTER

YATO	L (mm)	
YT-21160	160	6/36

1000V
VDE CERTIFICATE
EN 60900:2012

GB Water pump pliers
D Wasserpumpenzange
PL Szczypce nastawne
RUS Клещи переставные
CZ Keleště siko
H Vizpumpafogó
RO Clește papagal
F Pince réglable
I Pinze regolabili
E Alicates de fontanero ajustables
CN 水泵钳

250 mm CrV 1000 V DVE



HALF
DOUBLE
BLISTER

YATO	L (mm)	
YT-21161	250	6/24

1000V
VDE CERTIFICATE
EN 60900:2012

GB Insulated flat nose pliers
D Sicherheitsklammer mit Haken
PL Szczypce płaskie izolowane
RUS Клещи для замены предохранителей
CZ Izolované kleště s plochými čelistmi
H Rugós szorító
RO Patent izolat
F Pince plate isolée
I Pinze plate plastica isolati
E Alicates punta plana aislantes
CN 绝缘平嘴钳

200 mm CrV 1000 V DVE



POLYBAG

YATO	L (mm)	
YT-21191	200	6/48

1000V
VDE CERTIFICATE
EN 60900:2012

GB Insulated ring wrench
 D Einringschlüssel vollisoliert
 PL Klucz oczkowy odgięty izolowany
 RUS Ключ накидной односторонний изолированный

CZ Očkový klíč, izolovaný
 H Hajlítotszárú csillagkulcs
 RO Cheie inelara izolata
 F Clé polygonale coudée isolée

I Chiave poligonale piegato isolato
 E Llave de estrella acodada aislante
 CN 绝缘梅花扳手



1000V
 VDE CERTIFICATE
 EN 60900:2012

POLYBAG

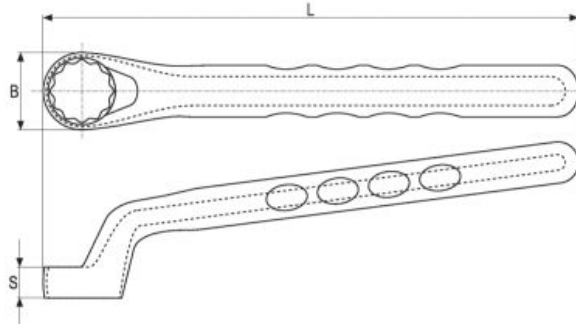

YATO	Ø (mm)	L (mm)	B (mm)	S (mm)	
YT-20980	6	150	16.0	5.5	6/126
YT-20981	7	150	18.0	5.7	6/126
YT-20982	8	155	19.0	6.1	6/126
YT-20983	9	155	20.0	7.2	6/126
YT-20984	10	170	21.0	7.3	6/90
YT-20985	11	170	22.5	7.7	6/90
YT-20986	12	190	22.5	8.5	6/90
YT-20987	13	190	26.5	9.0	6/90
YT-20988	14	205	28.0	9.5	6/90
YT-20989	15	205	29.0	9.5	6/90
YT-20990	16	215	31.0	10.2	6/90
YT-20991	17	215	32.0	10.7	6/90
YT-20992	18	230	35.0	11.5	6/90
YT-20993	19	230	36.0	12.0	6/90
YT-20994	21	245	39.0	13.0	6/48
YT-20995	22	245	41.0	12.2	6/48
YT-20996	24	265	44.0	13.0	6/48
YT-20997	27	290	48.0	14.5	4/40
YT-20998	30	310	52.0	15.2	4/40
YT-20999	32	310	55.0	16.5	4/40

7

GB Insulated open end wrench
 D Doppelmaulschlüssel isoliert
 PL Klucz płaski izolowany
 RUS Ключ рожковый односторонний изолированный

CZ Otvřený klíč, izolovaný
 H Válláskulcs
 RO Cheie fixă izolata
 F Clé plate isolée

I Chiave piatta isolato
 E Llave fija aislante
 CN 绝缘开口扳手



1000V
 VDE CERTIFICATE
 EN 60900:2012

POLYBAG

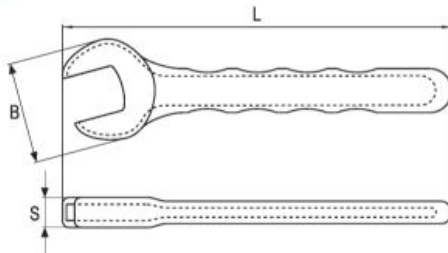

YATO	Ø (mm)	L (mm)	B (mm)	S (mm)	
YT-20950	6	90	23	7.0	6/108
YT-20951	7	90	25	7.0	6/108
YT-20952	8	100	27	7.5	6/108
YT-20953	9	100	29	7.5	6/108
YT-20954	10	110	31	8.0	6/108
YT-20955	11	110	34	8.5	6/108
YT-20956	12	130	36	8.5	6/108
YT-20957	13	135	39	10.5	6/108
YT-20958	14	145	40	10.5	6/72
YT-20959	15	150	42	11.5	6/72
YT-20960	16	160	43	11.5	6/72
YT-20961	17	160	47	12.5	6/72
YT-20962	18	175	50	13.0	6/72
YT-20963	19	175	53	14.0	6/72
YT-20964	21	195	55	14.0	6/66
YT-20965	22	195	58	14.0	6/66
YT-20966	24	225	62	16.5	6/66
YT-20967	27	250	69	18.0	4/60
YT-20968	30	290	75	19.0	4/48
YT-20969	32	310	79	20.0	4/48

GB Insulated T-handle wrench
 D Steckschlüssel T-griff vollisoliert
 PL Rekojeść typu „T” izolowana
 RUS Ручка Т-образная изолированная
 CZ Klíč nástrčný typ „T”, izolovaný
 H „T” típusú dugókulcs

RO Manerț tip „T” izolat
 F Clé à tube en „T” isolée
 I Chiave a bussola tipo „T” isolati
 E Llave tubular „T” aislante
 CN 绝缘T型扳手

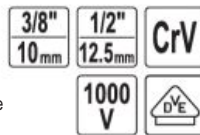

GB Insulated adjustable wrench
 D Rollgabelschlüssel isoliert
 PL Klucz nastawny izolowany
 RUS Ключ разводной изолированный
 CZ Izolovaný staviteľný klíč
 H Állítható svédkulcs
 RO Cheie reglabilă izolata
 F Clé à molette isolée
 I Isolati chiave regolabile
 E Llave ajustable aislante
 CN 绝缘活络扳手

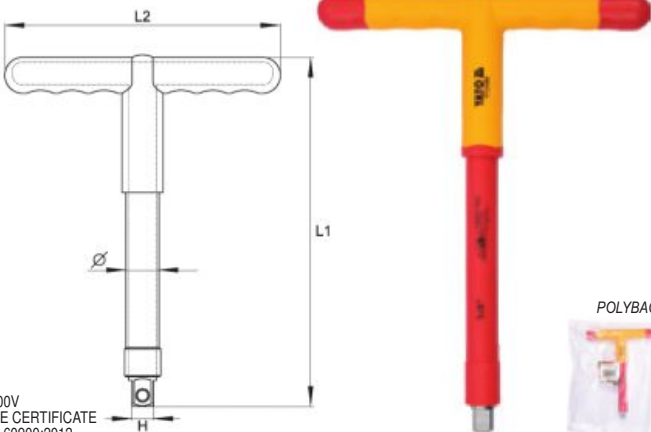

1000V
 VDE CERTIFICATE
 EN 60900:2012

POLYBAG



YATO	Ø H	L1 (mm)	L2 (mm)	Ø (mm)	
YT-21095	3/8" (9.5 mm)	207	160	15.6	4/32
YT-21096	1/2" (12.7 mm)	207	160	19.3	4/32

1000V
 VDE CERTIFICATE
 EN 60900:2012

POLYBAG



YATO	L (mm)	
YT-20940	200	6/48
YT-20941	250	6/36
YT-20942	300	4/24

- GB** Insulated hexagonal socket
D Sechskantenschlüssel vollisoliert
PL Nasadka sześciokątna izolowana
RUS Головка шестигранная короткая изолированная
CZ Šestihranný nástavec, izolovaný
H Hatszögű rátét
RO Cheie tubulară hexagonală izolată
F Douille courte isolée
I Chiave a bussola esagonale isolato
E Boquilla hexagonal corta aislante
CN 绝缘六角套筒

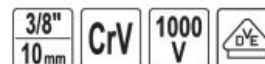
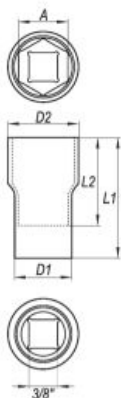

1000V VDE CERTIFICATE EN 60900:2012

YATO	Ø A (mm)	D1 (mm)	D2 (mm)	L1 (mm)	L2 (mm)	
YT-21008	8	18	15.1	45	28	7/126
YT-21010	10	18	18.7	45	28	7/126
YT-21011	11	18	20.0	45	28	7/126
YT-21012	12	18	21.2	45	28	7/126
YT-21013	13	18	22.5	45	28	7/126
YT-21014	14	18	23.7	45	28	7/126
YT-21016	16	18	26.2	45	28	7/126
YT-21017	17	18	27.5	45	28	7/126
YT-21018	18	18	28.7	45	30	5/90
YT-21019	19	18	30.0	47	30	5/90
YT-21021	21	18	32.6	47	30	5/90
YT-21022	22	18	33.7	47	30	5/90



POLYBAG

- GB** Insulated extension bar
D Verlängerung vollisoliert
PL Przedłużka izolowana
RUS Удлинитель для воротка
CZ Prodlužovací přípravek, izolovaný
H Toldalék
RO Prelungitor izolat
F Rallonge isolée
I Prolunga isolato
E Tubo de prolongación aislante
CN 绝缘接杆

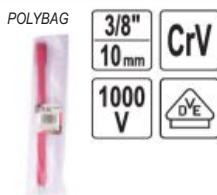

1000V VDE CERTIFICATE EN 60900:2012

YATO	Ø	D1 (mm)	D2 (mm)	L1 (mm)	L2 (mm)	
YT-21055	3/8" (9.5 mm)	23	15.5	125	141	18/72
YT-21056	3/8" (9.5 mm)	23	15.5	250	266	12/48

- GB** Insulated hexagonal socket
D Sechskantenschlüssel vollisoliert
PL Nasadka sześciokątna izolowana
RUS Головка шестигранная короткая изолированная
CZ Šestihranný nástavec, izolovaný
H Hatszögű rátét
RO Cheie tubulară hexagonală izolată
F Douille courte isolée
I Chiave a bussola esagonale isolato
E Boquilla hexagonal corta aislante
CN 绝缘六角套筒

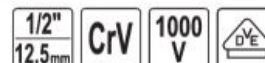
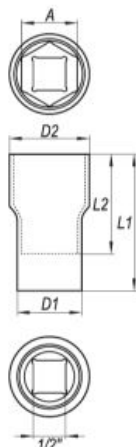

1000V VDE CERTIFICATE EN 60900:2012

YATO	Ø A (mm)	D1 (mm)	D2 (mm)	L1 (mm)	L2 (mm)	
YT-21030	10	27	19.5	55	38	12/144
YT-21031	11	27	20.7	55	38	12/144
YT-21032	12	27	22.0	55	38	12/144
YT-21033	13	27	23.2	55	38	12/144
YT-21034	14	27	24.5	55	38	12/144
YT-21036	16	27	27.0	55	38	12/144
YT-21037	17	27	28.5	55	38	12/144
YT-21038	18	27	29.5	55	38	12/144
YT-21039	19	27	30.7	55	38	12/144
YT-21041	21	27	33.2	55	38	10/110
YT-21042	22	27	34.5	55	38	10/110
YT-21044	24	27	37.0	60	38	10/110
YT-21047	27	27	38.8	60	38	6/66
YT-21050	30	27	42.8	60	38	6/66
YT-21052	32	27	44.8	60	38	6/66



POLYBAG

- GB** Insulated extension bar
D Verlängerung vollisoliert
PL Przedłużka izolowana
RUS Удлинитель для воротка
CZ Prodlužovací přípravek, izolovaný
H Toldalék
RO Prelungitor izolat
F Rallonge isolée
I Prolunga isolato
E Tubo de prolongación aislante
CN 绝缘接杆

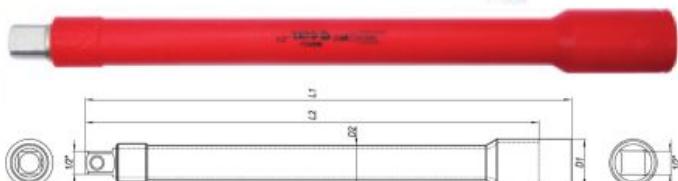
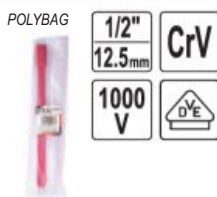

1000V VDE CERTIFICATE EN 60900:2012

YATO	Ø	D1 (mm)	D2 (mm)	L1 (mm)	L2 (mm)	
YT-21057	1/2" (12.7 mm)	27	19.1	125	141	6/72
YT-21058	1/2" (12.7 mm)	27	19.1	250	266	8/32

- GB** Insulated ratchet handle
D Hebelumschaltknarre vollisoliert
PL Grzechotka izolowana
RUS Трещотка диэлектрическая
CZ Řehtačka, izolovaná
H Racsnis hajtókar
RO Antrenor cu clichet izolat
F Clé à cliquet isolée
I Cricchetto bussola isolato
E Carraca aislante
CN 绝缘棘轮扳手



POLYBAG

1000V VDE CERTIFICATE EN 60900:2012

YATO	Ø	T	L (mm)	
YT-21072	1/2" (12.7 mm)	36	250	6/36

- GB** Insulated star bit socket
D Aufsteckschlüssel vollisoliert
PL Klucze trzpieniowe izolowane
RUS Головка торцевая с вставкой hex изолированная
CZ Čerové klíče izolované
H Csapkulcs
RO Chei cu cozi izolat
F Douille tournevis isolée
I Chiave esagonale isolato
E Llaves de mandril aislante
CN 绝缘套筒批

POLYBAG

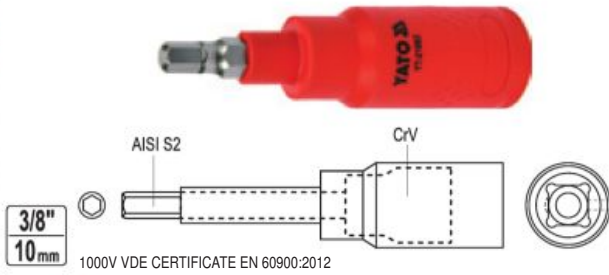

1000V VDE CERTIFICATE EN 60900:2012

YATO	Ø	Hex	L (mm)	torque / moment obrotowy max. (Nm)	Box
YT-21080	3/8" (9.5 mm)	4	75	16.0	12/144
YT-21081	3/8" (9.5 mm)	5	75	30.0	12/144
YT-21082	3/8" (9.5 mm)	6	75	52.0	12/144
YT-21083	3/8" (9.5 mm)	8	75	120.0	12/144

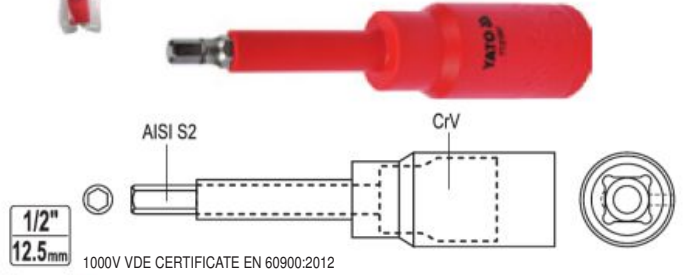

1000V VDE CERTIFICATE EN 60900:2012

YATO	Ø	Hex	L (mm)	torque / moment obrotowy max. (Nm)	Box
YT-21085	1/2" (12.7 mm)	4	120	16.0	18/144
YT-21086	1/2" (12.7 mm)	5	120	30.0	18/144
YT-21087	1/2" (12.7 mm)	6	120	52.0	18/144
YT-21088	1/2" (12.7 mm)	8	120	120.0	18/144
YT-21089	1/2" (12.7 mm)	10	120	220.0	18/144

7

- GB** Insulated hex key
D Steckschlüssel
PL Klucz sześciokątny izolowany
RUS Накондной гаечный ключ угловой
CZ Imbusové klíče izolované
H Imbisz kulcs
RO Imbusuri hexagonale izolate
F Clés allen isolée
I Chiave esagonale isolato
E Punta vaso aislante
CN 绝缘内六角扳手

POLYBAG

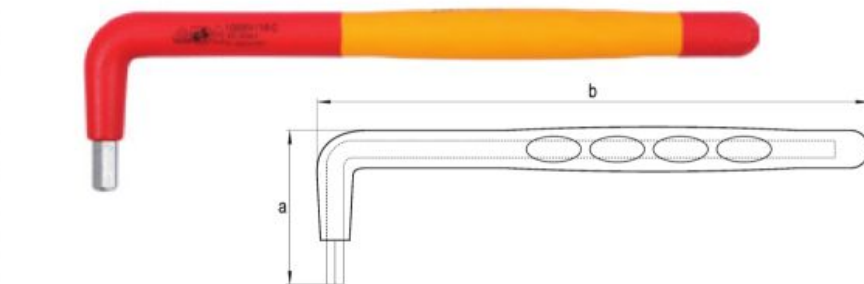

1000V VDE CERTIFICATE EN 60900:2012

YATO	Ø (mm)	a (mm)	b (mm)	Box
YT-21120	3.0	25	130	12/144
YT-21121	4.0	40	140	12/144
YT-21122	5.0	45	160	12/144
YT-21123	6.0	47	180	10/120
YT-21125	8.0	50	200	10/120
YT-21126	10.0	52	235	6/48
YT-21127	12.0	60	260	6/48

- GB** Insulated spring clamp
D Federklemme vollisoliert
PL Ścisk sprężynowy izolowany
RUS Струбцина изолированная
CZ Pružinové upínadlo izolované
H Rugós szorító
RO Cleste presa pt. lemn izolat
F Pince de serrage isolée
I Pinze di bloccaggio isolate
E Pinza aislante
CN 弹簧夹



YATO	working capacity / zakres pracy (mm)	L (mm)	Box
YT-21190	2-20	150	5/40

- GB** Quick interchangeable ratchet crimper set
D Kabelschuhzange
PL Zestaw do zaciskania konektorów
RUS Инструмент для обжима и зачистки проводов
CZ Kleště pro svěření zaciskania konektorů
H Krimpelő fogó
RO Clește sertizat conectori
F Pince à sertir pour connecteurs
I Set pinze i compare a connettori
E Pinzas de apretar de conectores
CN 棘轮压线钳组套



BMC & COLOR SLEEVE

YATO	mm ²	AWG	mm ²	AWG	mm ²	AWG	mm ²	AWG	Box
YT-2245	0.5-6.0	20-10	0.5-6.0	22-10	1.5-10.0	20-8	0.5-4.0	22-12	RG6, RG58, RG59, RG62 10

GB Ratchet crimping pliers
D Kabelschuhzange
PL Szczypce do zaciskania konektorów
RUS Инструмент для обжима
и зачистки проводов

CZ Kleště pro svěráni zaciskania konektorů
H Krimpelő fogó
RO Clește sertizat conectori
F Pince pour serrer les connecteurs

I Pinze i compare a connettori
E Pinzas de apretar de conectores
CN 棘轮压线钳

SLIDING
CARD



YATO	mm ²	AWG	Box
YT-2250	0.5-6.0	20~10	5/30

YATO	mm ²	AWG	Box
YT-2300	0.5-6.0	20~10	5/30

GB Ratchet crimping pliers
D Kabelschuhzange
PL Szczypce do zaciskania konektorów
RUS Инструмент для обжима
и зачистки проводов

CZ Kleště pro svěráni zaciskania konektorů
H Krimpelő fogó
RO Clește sertizat conectori
F Pince pour serrer les connecteurs

I Pinze i compare a connettori
E Pinzas de apretar de conectores
CN 棘轮压线钳

BLISTER
CARD



YATO	mm ²	AWG	mm ²	AWG	Box
YT-2255	0.08-2.0	28-14	0.12-0.3	26-22	10/60

YATO	mm ²	AWG	mm ²	AWG	mm ²	AWG	Box
YT-2256	0.08-2.0	28-14	0.3-6.0	22-10	0.12-0.3	26-22	10/60

GB Ratchet crimping pliers
D Kabelschuhzange
PL Szczypce do zaciskania konektorów
RUS Инструмент для обжима
и зачистки проводов

CZ Kleště pro svěráni zaciskania konektorů
H Krimpelő fogó
RO Clește sertizat conectori
F Pince pour serrer les connecteurs

I Pinze i compare a connettori
E Pinzas de apretar de conectores
CN 棘轮压线钳

SLIDING
CARD



YATO	mm ²	AWG	Box
YT-2296	0.5-6.0	22-10	5/30

YATO	mm ²	AWG	Box
YT-2246	0.5-6.0	22-10	5/30



YATO	mm ²	AWG	Box
YT-2251	0.5-6.0	22-10	5/30

YATO	mm ²	AWG	Box
YT-2302	0.5-6.0	22-10	5/30



YATO	mm ²	AWG	Box
YT-2307	0.5-2.5	22~14	6/36

YATO	mm ²	AWG	Box
YT-2298	RG6, RG58, RG59, RG62		5/30

GB Ratchet crimping pliers
 D Kabelschuhzange
 PL Szczypce do zaciskania konektorów
 RUS Инструмент для обжима и зачистки проводов

CZ Kleště pro svěráni zaciskania konektorů
 H Krimpelő fogó
 RO Clește sertizat conectori
 F Pince pour serrer les connecteurs

I Pinze i compare a connettori
 E Pinzas de apretar de conectores
 CN 棘轮压线钳

SLIDING CARD



YATO	mm ²	AWG	
YT-2247	1.5-10.0	20-8	5/30

YATO	mm ²	AWG	
YT-2297	1.5-10.0	20-8	5/30



YATO	mm ²	AWG	
YT-2299	0.5-4.0	22-12	5/30

YATO	mm ²	AWG	
YT-2249	0.5-4.0	22-12	5/30

GB Ratchet crimping pliers
 D Kabelschuhzange
 PL Szczypce do zaciskania konektorów
 RUS Инструмент для обжима и зачистки проводов

CZ Kleště pro svěráni zaciskania konektorů
 H Krimpelő fogó
 RO Clește sertizat conectori
 F Pince pour serrer les connecteurs

I Pinze i compare a connettori
 E Pinzas de apretar de conectores
 CN 棘轮压线钳

SLIDING CARD

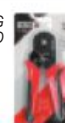

HRC 44-47



YATO	mm ²	
YT-2240	0.2-6.0	6/36

YATO	mm ²	
YT-2305	0.2-6.0	6/36

GB Crimping pliers
 D Kabelschuhzange
 PL Szczypce do zaciskania konektorów
 RUS Инструмент для обжима и зачистки проводов
 CZ Kleště pro svěráni zaciskania konektorů

H Krimpelő fogó
 RO Clește sertizat conectori
 F Pince pour serrer les connecteurs
 I Pinze i compare a connettori
 E Pinzas de apretar de conectores
 CN 棘轮压线钳

SLIDING CARD



SK5

YATO		
YT-2242	RJ45	10/60

YATO		
YT-2243	RJ45, RJ11	8/48



SK5



SK5

YATO		
YT-22422	RJ45, RJ11, RJ12	10/60

YATO		
YT-2244	RJ45, RJ11, RJ12, RJ22	10/60

- GB Hydraulic pliers
- D Manuelle Hydraulikpresse
- PL Ręczna praska hydrauliczna
- RUS Ручной гидравлический обжимной инструмент
- CZ Ruční hydraulický lis
- H Kézi hidraulikus prés
- RO Presă hidraulică manuală
- F Pince à sertir
- I Pressa idraulica manuale
- E Prensa hidráulica manual
- CN 液压钳



BMC & COLOR SLEEVE

YATO	crimping size range / zakres zaciskania (mm²)		L (mm)	pressure / nacisk (T)	crimping jaws size / rozmiar szczęk zaciskających (mm²)	
	aluminium	copper / miedź				
YT-22860	10-95	10-120	415	8	10; 16; 25; 35; 50; 70; 95; 120	4
YT-22861	16-185	16-240	470	12	16; 25; 35; 50; 70; 95; 120; 150; 185; 240	3
YT-22862	16-240	16-300	470	18-20	16; 25; 35; 50; 70; 95; 120; 150; 185; 240; 300	3

- GB Crimping pliers
- D Kabelschuhzange
- PL Szczypce do zaciskania konektorów
- RUS Инструмент для обжима и зачистки проводов
- CZ Kleště pro svěření zaciskania konektorů
- H Krimpelő fogó
- RO Clește sertizat conectori
- F Pince pour serrer les connecteurs
- I Pinze i compare a connettori
- E Pinzas de apretar de conectores
- CN 棘轮压线钳

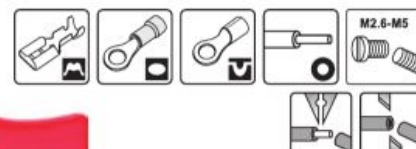

SLIDING CARD

YATO	mm²		AWG		mm²		AWG		
YT-2254	0.5-5.0	20-10	0.5-5.0	20-10	0.5-5.5	20-10	0.5-5.0	20-10	12/48

- GB Wire stripper
- D Abisolierzange
- PL Ściągacz izolacji
- RUS Съёмник изоляции
- CZ Odizolovací klejtle
- H Blankolo fogo
- RO Decablator
- F Extracteur d'isolation
- I Pinze per scariare isolamento
- E Extractor de aislado
- CN 万用剥线钳



SLIDING CARD

YATO	mm²		AWG		mm²		AWG		
YT-22930	1.5-6.0	22-10	1.5-6.0	22-10	0.75-6.0	22-10		12/48	

- GB Wire stripper
- D Abisolierzange
- PL Ściągacz izolacji
- RUS Съёмник изоляции

- CZ Odizolovací klejtle
- H Blankolo fogo
- RO Decablator

- F Extracteur d'isolation
- I Pinze per scariare isolamento

- E Extractor de aislado
- CN 万用剥线钳



SLIDING CARD



12 PCS COLOR BOX

YATO	mm²		AWG		mm²		AWG		PCS packing	
YT-2293	1.25-2.5	8-12	1.0	8				12	72	

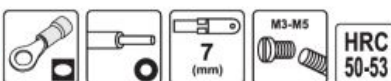

SLIDING CARD

YATO	mm²		AWG		mm²		AWG		
YT-2295	0.5-6.0	22-10	0.8-2.6	20-10				12/72	

GB Wire stripper
 D Abisolierzange
 PL Ściągacz izolacji
 RUS Съёмник изоляции
 CZ Odizolovací klejce

H Blankolo fogo
 RO Decablator
 F Extracteur d'isolation

I Pinze per scaricare isolamento
 E Extractor de aislado
 CN 万用剥线钳

SLIDING CARD



HRC 48-52

YATO	mm ²	AWG	
YT-2266	0.25-1.3	30-16	10/60



HRC 48-52

YATO	mm ²	AWG	
YT-2267	0.8-2.6	20-10	10/60



HRC 50-53

YATO	mm ²	AWG	
YT-2294	0.64-2.6	22-10	12/120



HRC 48-52

YATO	mm ²	AWG	
YT-2319	0.8-2.6	20-10	10/60

GB Universal wire stripper & ratchet crimping pliers
 D Multifunktion Abisolierzange & Kabelschuhklemmzange
 PL Uniwersalny ściągacz izolacji i szczypce do zaciskania konektorów

RUS Инструмент для снятия изоляции и зажима проводов
 CZ Univerzální odizolovací klejce & kleště pro svěráni zaciskania konektorů
 H Blankolo fogo & krimpeló fogó
 RO Decablator universal & clește sertizat conectori

F Extracteur d'isolation multifonction
 I Pinze per scaricare isolamento
 E Extractor de aislado multifunción
 CN 万用剥线钳



HRC 52-57



7-8 (mm)

YATO	mm ²	AWG	mm ²	AWG	mm ²	AWG	
YT-2270	0.5-6.0	22-10	1.5-6.0	22-10	0.2-6.0	24-10	5/30

HALF DOUBLE BLISTER



SLIDING CARD



YATO	mm ²	AWG	mm ²	AWG	mm ²	AWG	
YT-2313	0.5-6.0	22-10	1.5-6.0	22-10	0.2-6.0	24-10	5/30

GB Universal wire stripper & ratchet crimping pliers
 D Multifunktion Abisolierzange & Kabelschuhklemmzange
 PL Uniwersalny ściągacz izolacji i szczypce do zaciskania konektorów
 RUS Инструмент для снятия изоляции и зажима проводов
 CZ Univerzální odizolovací klejce & kleště pro svěráni zaciskania konektorů
 H Blankolo fogo & krimpeló fogó
 RO Decablator universal & clește sertizat conectori
 F Extracteur d'isolation multifonction
 I Pinze per scaricare isolamento
 E Extractor de aislado multifunción
 CN 剥线钳



SLIDING CARD



YATO	mm ²	AWG	mm ²	AWG	
YT-2278	0.5-6.0	22-10	0.2-6.0	24-10	10/60

GB Automatic wire stripper
D Automatische Abisolierzange
PL Automacyjny ściągacz izolacji
RUS Клещи для удаления изоляции
CZ Automatický stahovač izolace
H Automatikus szigeteléslehúzó
RO Clește automat pt. desizolat

F Extracteur d'isolation automatique
I Pinze per scariare isolamento
E Pelacables automatico
CN 万用剥线钳

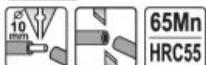

YATO				
YT-2268				10/60



YATO				
YT-2275	mm ²	AWG		10/60
	0.5-6.0	20-10		



YATO				
YT-2276	mm ²	AWG		8/48
	1.0-3.2	18-12		



YATO				
YT-2316	mm ²	AWG		8/48
	1.0-3.2	18-12		

GB Electrical cutter
D Seitenschneider
PL Obcinak elektryczny
RUS Инструмент для обрезки проводов
CZ Elektrické upichováky
H Kábelvágó
RO Clește tăietor - electrician

F Coupeur isolé
I Pinza per elettronica
E Cortacables eléctricos
CN 电子斜嘴钳



YATO				
YT-2263	mm ²	AWG	L (mm)	12/120
	0.5-1.5	20-18	130	

GB Wire stripper
D Abisolierzange
PL Ściągacz izolacji
RUS Съёмник изоляции
CZ Odizolovací klejste
H Blankoló foga

RO Decablator
F Extracteur d'isolation
I Pinze per scariare isolamento

E Extractor de aislado
CN 万用剥线钳

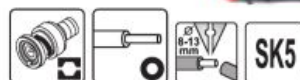

YATO				
YT-2274	RG9, RG59	mm ²	AWG	15/90
		0.5-6.0	20-10	

GB Electrical cutter
D Seitenschneider
PL Obcinak elektryczny
RUS Инструмент для обрезки проводов
CZ Elektrické upichováky
H Kábelvágó
RO Clește tăietor - electrician

F Coupeur isolé
I Pinza per elettronica
E Cortacables eléctricos
CN 电子斜嘴钳

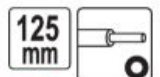

YATO				
YT-2260	mm ²	AWG	L (mm)	15/150
	0.5-1.5	20-18	125	



YATO				
YT-2261	mm ²	AWG	L (mm)	15/150
	0.5-1.5	20-18	125	

GB Electrical cutter
D Seitenschneider
PL Obcinak elektryczny
RUS Инструмент для обрезки проводов
CZ Elektrické upichováky
H Kábelvágó
RO Clește tăietor - electrician

F Coupeur isolé
I Pinza per elettronica
E Cortacables eléctricos
CN 电子斜嘴钳



YATO				
YT-2262	mm ²	AWG	L (mm)	20/120
	0.5-1.5	20-18	125	

GB Cable cutter
D Kabelschere
PL Szczypce do cięcia przewodów
RUS Кабелперезы
CZ Elektrické upichováky
H Kábelvágó
RO Patent tăietor pt. electricie
F Pince pour câbles

I Cesoia per cavi elettrici
E Tijeras para cables
CN 电缆断线钳



YATO				
YT-2279	max. Ø (mm)		L (mm)	10/60
	10.5		170	

- GB Universal wire stripper
- D Universal Abisolierzange
- PL Uniwersalny ściągacz izolacji
- RUS Универсальный съёмник изоляции
- CZ Univerzální odizolovací klejte
- H Blankolo fogo
- RO Decablator universal
- F Dénuder et coupe-câble outil
- I Pinze per scariare isolamento
- E Extractor de aislado universal
- CN 剥线钳



HALF DOUBLE BLISTER

170 mm



YATO	mm ²	AWG	L (mm)	
YT-19691	1.6-3.2	14-8	170	6/24

- GB Cable cutter
- D Kabelschere
- PL Nożyce do kabli
- RUS Кабелерезы
- CZ Elektrické upichováky
- H Kábelvágó
- RO Patent tăietor pt. electrice
- F Cisailles à câbles
- I Cesioie per cavi
- E Tijeras para cables
- CN 电缆剪



STEEL
STAL

COLOR BOX

YATO	cutting range / max. przekrój cięcia (mm ²)	max. Ø (mm)	L (mm)	
YT-18610	125	12.5	370	20
YT-18611	250	18.0	580	10
YT-18612	500	25.0	770	5

- GB Cable stripper
- D Kabelmesser
- PL Nożyk do kabli
- RUS Нож кабельный
- CZ Nůž na kabele
- H Kábelkés
- RO Cuițas pt. cabluri
- F Couteau aux câbles
- I Coltellino per cavi
- E Cuchillo
- CN 电缆剥线钳



SLIDING CARD

Ø mm
8-28



YATO	Ø (mm)	
YT-2280	8-28	10/100

- GB Insulated electrician scissors
- D Elektrische Schere
- PL Nożyczki dla elektryków izolowane
- RUS Ножницы диэлектрические универсальные
- CZ Elektrické nůžky
- H Univerzális olló

- RO Foarfece - electrician izolate
- F Ciseaux pour electriciens
- I Forbici per elettricisti
- E Tijeras eléctricos
- CN 绝缘电工剪

160 mm
CrV
1000 V
D'E



POLYBAG

1000V VDE CERTIFICATE EN 60900:2012

YATO	L (mm)	
YT-21200	160	6/48

- GB Electrician scissors
- D Elektrische Schere
- PL Nożyczki dla elektryków
- RUS Ножницы универсальные
- CZ Elektrické nůžky
- H Univerzális olló
- RO Foarfece - electrician

- F Ciseaux pour electriciens
- I Forbici per elettricisti
- E Tijeras eléctricos
- CN 电工剪

140 mm
SS
STAINLESS STEEL
OIL RESISTANT
HRC 52-56



SLIDING CARD



YATO	L (mm)	
YT-1974	140	12/120

- GB Insulated cable knife
- D Kabelmesser gerade
- PL Nóż dla elektryków izolowany
- RUS Нож кабельный изолированный
- CZ Izolovaný nůž
- H Szerelőkés

- RO Cutit pt. cabluri izolat
- F Couteau d'électricien
- I Coltello per elettricisti isolato
- E Cuchillo electricista aislante
- CN 绝缘电工刀

180 mm
50 mm
65 Mn
1000 V
D'E



POLYBAG



1000V VDE CERTIFICATE EN 60900:2012

YATO	L (mm)	
YT-21210	180	6/72

- GB Insulated dismantling knife
- D Abmantelungsmesser
- PL Nóż demontażowy dla elektryków
- RUS Нож кабельный изолированный
- CZ Zahnutý nůž s vodičkem, izolovaný

- H Szerelőkés
- RO Cutit demontabil izolat
- F Couteau d'électricien
- I Coltello di smontaggio per elettricisti isolati
- E Cuchillo de desmontaje aislante
- CN 绝缘电工刀

155 mm
38 mm
65 Mn
1000 V
D'E



POLYBAG



1000V VDE CERTIFICATE EN 60900:2012

YATO	L (mm)	
YT-21211	155	6/72

GB Electrician's knife
D Montagemesser
PL Nóż składany monterski
RUS Нож складной

CZ Montážní nůž
H Szerelőkés
RO Cuțit pt. decablat
F Couteau d'électricien

I Coltello
E Cuchillo de montaje
CN 电工刀

SLIDING CARD



3CR13

HRC 42-48

85 mm
200 mm



YATO	L (mm)	
YT-7600	200	6/96

75 mm
190 mm



YATO	L (mm)	
YT-7601	190	6/96

GB Cable cutter
D Kabelschere
PL Szczypce do cięcia przewodów
RUS Кабелерезы
CZ Elektrické upichováky
H Kábelvágó
RO Patent tăietor pt. electricie
F Pince à couper les fils
I Pinze per tagliare i cavi
E Tijeras para cables
CN 电缆剪

SLIDING CARD



160 mm
210 mm
240 mm
CrV 50
DROP FORGED STEEL
STAL MŁUTA NA ZIMNO
HRC 55-60



- application: for copper and aluminium electric cables
- przeznaczenie: do cięcia miedzianych i aluminiowych kabli

YATO	L (mm)	max. Ø (mm)	
YT-1966	160	6	6/60
YT-1967	210	7	6/60
YT-1968	240	8	6/48

GB Insulated cable cutter
D Kabelschere
PL Szczypce do cięcia przewodów izolowane
RUS Кабелерезы
CZ Elektrické upichováky, izolované
H Kábelvágó

RO Cleste taiat cabluri izolat
F Pince renforcée isolée
I Pinze per tagliare i cavi isolati
E Tijeras para cables aislantes
CN 绝缘电缆剪

250 mm
CrV
1000 V
D'E



POLYBAG

1000V VDE CERTIFICATE EN 60900:2012

YATO	L (mm)	max. Ø (mm)	
YT-21141	250	80	6/36

GB Heavy duty cable cutter
D Schwere Drahtschere
PL Wzmocnione nożyce do cięcia przewodów
RUS Кабелерезы
CZ Elektrické upichováky
H Kábelvágó
RO Patent tăietor pt. electricie
F Pince renforcée à couper les fils
I Pinze per tagliare i cavi
E Tijeras para cables
CN 电缆剪

SLIDING CARD



240 mm
CrV 50
DROP FORGED STEEL
STAL MŁUTA NA ZIMNO
HRC 55-60



- application: for copper and aluminium electric cables
- przeznaczenie: do cięcia miedzianych i aluminiowych kabli

YATO	L (mm)	max. Ø (mm)	
YT-1969	240	9	6/48

GB Ratchet cable cutter
D Ratschenkabelschneider
PL Nożyce zapadkowe do kabli
RUS Кабелерез секторный
CZ Kleště na kabely, rohatka se západkou
H Racsnis kábelvágó
RO Cleste pt. taiat cablu cu clichet
F Cisailles à câbles
I Cricchetto taglia cavo
E Cortacables de carraca
CN 棘轮电缆剪

COLOR BOX



Cu/Al
CABLE
KABEL
60Si2Mn
HRC 50
CUTTING BLADE
GRIFFZE TRAGE



YATO	cutting range / max. przekrój cięcia (mm ²)	max. Ø (mm)	L (mm)	
YT-18600	240	17.5	300	10

GB Heavy duty cable cutter
D Schwere Drahtschere
PL Wzmocnione nożyce do cięcia przewodów
RUS Кабелерезы
CZ Elektrické upichováky
H Kábelvágó
RO Patent tăietor pt. electricie
F Pince renforcée à couper les fils
I Pinze per tagliare i cavi
E Tijeras para cables
CN 电缆剪

SLIDING CARD



230 mm
HRC 58-61
CrMo
Lever for increase cutting power
Ideal for copper and aluminium electric cables



YATO	L (mm)	max. Ø (mm)	
YT-1933	230	9	6/36



YATO	cutting range / max. przekrój cięcia (mm ²)	max. Ø (mm)	L (mm)	
YT-18602	380	22	380	10

GB Voltage tester
D Spannungsprüfer
PL Próbник napięcia
RUS Отвёртка с передачей

CZ Zkoušeč napětí
H Fáziskereső
RO Creion de tensiune
F Testeur de tension

I Cerca fase
E Comprobador de corriente
CN 测电笔

PLASTIC HANGER



190 mm 125-250 V~

In accordance with polish standard PN-E 08509:1988
Zgodny z polską normą PN-E 08509:1988

YATO	⊖	L (mm)	
YT-28300	3.0	190	12/144

GB Voltage tester
D Spannungsprüfer
PL Próbник napięcia
RUS Отвёртка с передачей

CZ Zkoušeč napětí
H Fáziskereső
RO Creion de tensiune
F Testeur de tension

I Cerca fase
E Comprobador de corriente
CN 测电笔

SLIDING CARD



1.5-9 V 50-500 Hz CONTINUITY TEST TEST CÍAGŁOŚCI 70-250 V 70-600 V POWER ZASILANE 2x1.5 V LR41 BATTERY* BATERIA* * BATTERY NOT INCLUDED * BATERIA NIE DOŁĄCZONO

YATO			
YT-2864			6/120

GB Voltage tester
D Spannungsprüfer
PL Próbnik napięcia
RUS Отвёртка с передачей

CZ Zkoušeč napětí
H Fáziskereső
RO Creion de tensiune
F Testeur de tension

I Cerca fase
E Comprobador de corriente
CN 测电笔

SLIDING CARD



1.5-9 V 50-500 Hz 70-250 V 70-1000 V POWER ZASILANE 2x1.5 V LR44 CONTINUITY TEST TEST CÍAGŁOŚCI

YATO			
YT-28631			6/120



GB Voltage tester
D Spannungsprüfer
PL Próbnik napięcia
RUS Отвёртка с передачей
CZ Zkoušeč napětí
H Fáziskereső

RO Creion de tensiune
F Testeur de tension
I Cerca fase
E Comprobador de corriente de corriente
CN 测电笔

SLIDING CARD



CONTINUITY TEST TEST CÍAGŁOŚCI LED LIGHT OWIETLNE LED ILLUMINATION SPONALAKA 1.5V 2x AAA! SL 4.5 mm

GB Digital voltage tester
D Digitaler-Spannungsprüfer
PL Wskaźnik elektryczny
RUS Тестер напряжения цифровой
CZ Zkoušečka napětí digitální

H Digitális voltmérő
RO Tester digital pt. tensiune electrica
F Testeur de tension type tournevis
I Cerca fase digitale
E Indicador eléctrico digital
CN 数显测电笔

SLIDING CARD



12-250 V 50-500 Hz TEST LCD DISPLAY WYWIĘTLACZ

YATO			
YT-2861			20/500



90-1000 V ON / OFF AUTO POWER OFF WYŁĄCZANIE AUTOMATYCZNE SENSITIVITY CZUŁOŚĆ

YATO	⊖		
YT-28310	4.5		12/96



NO BATTERY NEEDED NIE POTRZEBUJĄC BATERII

YATO			
YT-2861			20/500



5-1000 V 50-400 Hz SENSITIVITY CZUŁOŚĆ

YATO	⊖		
YT-28311	4.5		30/60



LED NO BATTERY NEEDED NIE POTRZEBUJĄC BATERII

YATO			
YT-2862			20/500



90-1000 V

YATO	⊖		
YT-28312	4.5		12/240



LED POWER ZASILANE 3x1.5 V LR41 BATTERY BATERIA

YATO			
YT-28630			6/120

- GB Stud finder
- D Entfernungsmesser
- PL Wykrywacz profili i przewodów
- RUS Цифровой детектор
- CZ Digitální detektor
- H Digitális kereső műszer
- RO Detector digital
- F Détecteur de métaux et de câbles électriques
- I Detector digitale
- E Escáner de pared
- CN 墙体探测仪

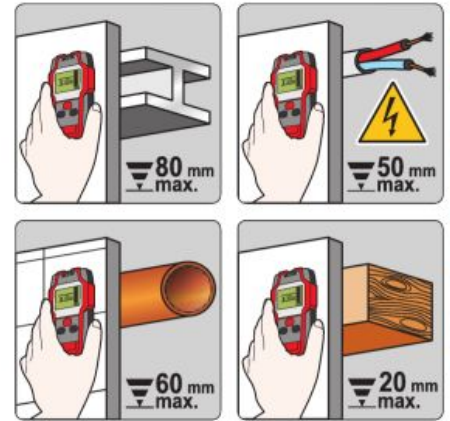

YATO
YT-73131 40

- GB Digital universal multimeter
- D Universell digital Messgerät
- PL Cyfrowy miernik uniwersalny
- RUS Универсальный цифровой измеритель

- CZ Digitální multimetr univerzální
- H Digitális multiméter
- RO Multimetru digital universal
- F Multimètre numérique

- I Universale tester digitale
- E Manómetro digital universal
- CN 数字万用表



YATO
YT-73080 50

YATO
YT-73081 50

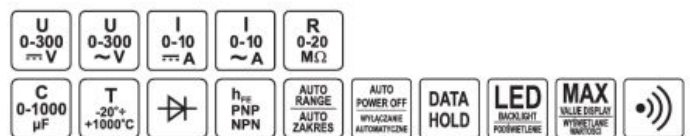
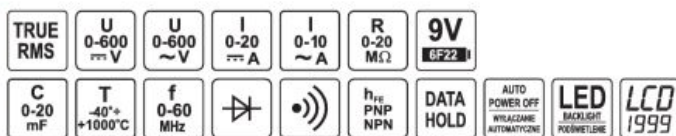

YATO
YT-73083 20

YATO
YT-73084 44

GB Digital universal multimeter
 D Universell digital Messgerät
 PL Cyfrowy miernik uniwersalny

RUS Универсальный цифровой измеритель
 CZ Digitální multimetr univerzální
 H Digitális multiméter

RO Multimetru digital universal
 F Multimètre numérique
 I Universale tester digitale

E Manómetro digital universal
 CN 数字万用表



7

for / dla: YT-73090

COLOR BOX



TRUE RMS	U 0-600 ~V	U 0-600 ~V			
I 0-10 ~A	I 0-10 ~A	R 0-60 MΩ	C 0-60 mF	0.1%+99%	T -40°+1370°C
f 0-60 MHz	h _{FE} PNP NPN	DATA HOLD	AUTO RANGE AUTO ZAKRES		
AUTO POWER OFF	LED BACKLIGHT	MAGNETIC BACKLIGHT HOLD	MAX & MIN DISPLAY	LCD 5999	9V

NYLON CASE & COLOR BOX



L1 L2 L3	U 0-600 ~V	U 0-600 ~V	I 0-10 ~A	I 0-10 ~A	
R 0-40 MΩ	C 0-100 μF	f 100 kHz	5%+99%	T -20°+1000°C	
AUTO RANGE	AUTO POWER OFF	DATA HOLD	LED BACKLIGHT	REL RELATIVE VALUE	

NYLON CASE & COLOR BOX



5 in 1	U 0-300 ~V				
U 0-300 ~V	I 0-10 ~A	I 0-10 ~A	R 0-40 MΩ	C 0-100 μF	f 200 kHz
5%+99%	T -20°+1000°C	%RH 30%+90%	3.5-102dB	40000 lx	
AUTO RANGE	AUTO POWER OFF	DATA HOLD	LED BACKLIGHT	REL RELATIVE VALUE	

YATO	
YT-73085	20

YATO	
YT-73086	24

YATO	
YT-73087	24



NYLON CASE & COLOR BOX



I 0-600 ~A					
for / dla: YT-73085					

U 0-600 ~V	U 0-600 ~V				
I 0-600 ~A	R 0-200 MΩ	T -20°+1000°C			
AUTO RANGE	AUTO POWER OFF	DATA HOLD	LED BACKLIGHT	MAX VALUE DISPLAY	

NYLON CASE & COLOR BOX



YATO	
YT-73090	50

YATO	
YT-73091	20

GB Electric glue gun
D Heissklebepistole
PL Pistolet do klejenia
RUS Пистолет для клея
CZ Pistolet na lepení
H Ragasztópisztoly

RO Pistol pt. lipit
F Pistolet à colle
I Pistola colla
E Pistola de cola
CN 热胶枪

230V~50Hz	35 (400) W	150-200 °C	15 g/min
	3-6 min	∅ 11 mm	



COLOR BOX

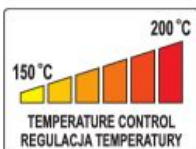

YATO	W	diameter of glue stick / średnica wkładu (mm)	capacity / wydajność (g/min)	
YT-82401	35 (400)	11	15	12/24

GB Electric glue gun
D Heissklebepistole
PL Pistolet do klejenia
RUS Пистолет для клея
CZ Pistolet na lepení
H Ragasztópisztoly

RO Pistol pt. lipit
F Pistolet à colle
I Pistola colla
E Pistola de cola
CN 热胶枪

230V~50Hz	20 (80) W	180-200 °C	15 g/min
	3-5 min	3x ∅11mm	



DOUBLE BLISTER



YATO	W	diameter of glue stick / średnica wkładu (mm)	capacity / wydajność (g/min)	
YT-82402	20 (80)	11	15	12/48

7

GB Soldering station
D Lötstation
PL Stacja lutownicza
RUS Паяльная станция
CZ Letovacia stanice
H Forrasztópáka állomás
RO Stație de lipit
F Station de soudage
I Stazione digitale di saldatura
E Estación de soldadura
CN 数显焊台



230V~50Hz	48 W	150-450 °C	
	7.1 mm ∅ / 65 mm	LCD DISPLAY / WYDMYSLACZ	1°C

COLOR BOX



YATO	W	temp. (°C)	
YT-82455	48	150-450	4

GB Soldering iron
D Lötkolben
PL Lutownica orogowa
RUS Электропаяльник

CZ Pájka odporová
H Forrasztópáka
RO Ciocan de lipit
F Fer à souder

I Saldatore a stagno
E Soldador de resistencia
CN 电烙铁

HANGING DISPLAY COLOR BOX



230V~50Hz	400-520 °C	2-3 min
-----------	------------	---------

YATO	W	max. temperature of soldering tip / max. temperatura grotu (°C)	dimensions of soldering tip / wymiary grotu (mm)	
YT-8271	30	400	∅3.8 x 70	16
YT-8272	60	500	∅6.0 x 78	16
YT-8273	80	520	∅6.8 x 64	16

GB Transformer soldering gun
D Lötpestole
PL Lutownica transformatorowa
RUS Паяльник электрический
CZ Transformátorová páječka
H Forrasztópáka
RO Aparat de lipit letcon cu transformator

F Fer à souder
I Saldatore istantaneo
E Soldador transformador
CN 电烙铁

230V~50Hz	180 W	WORKING MODE / TRYB PRACY S2 20%	
	0-600 °C	LED	



BMC & COLOR SLEEVE



WORK LIGHT OŚWIETLENIE PRACY

YATO	W	temp. (°C)	
YT-8245	180	0-600	10

GB Transformer soldering gun
D Lötpestole
PL Lutownica transformatorowa
RUS Паяльник электрический
CZ Transformátorová páječka
H Forrasztópáka
RO Aparat de lipit letcon cu transformator
F Fer à souder

I Saldatore istantaneo
E Soldador transformador
CN 电烙铁

230V~50Hz	200 W	LED
	WORKING MODE / TRYB PRACY S2 20%	
	351-450°C (A)	201-350°C (B)
	70-200°C (C)	



BMC & COLOR SLEEVE



WORK LIGHT OŚWIETLENIE PRACY

YATO	W	temp. (°C)	
YT-82451	200	70-500	10

GB Desoldering pump RUS Шприц для удаления припоя H Ónszippantó I Pompa aspira stagno
 D Entlötlötpumpe CZ Odrápěcí sací pumpa RO Pompa fludor E Bomba desoldadora
 PL Odsysacz do cyny F Pompe à étain CN 全铝手动吸锡器



SLIDING CARD
PTFE TIP



YATO		
YT-82742		100/400



YATO		
YT-82743		100/200



YATO		
YT-82744		50/100

GB Tweezer CZ Pinzeta I Pinza
 D Pinzette H Csipesz E Pinzas
 PL Pęseta RO Pensetă CN 镊子
 RUS Пинцет F Pince

SLIDING CARD



302
 STAINLESS STEEL
 STAL INOXIDIZANTA

ANTI MAGNETIC
 ANTYMAGNETYCZNA

ANTIACID
 KWASO-ODPORNA

140 mm **HRC 30**



YATO	L (mm)	
YT-6903	140	20/240

115 mm **HRC 30**



YATO	L (mm)	
YT-6907	115	20/240

140 mm **HRC 40**



YATO	L (mm)	
YT-6916	140	20/240

GB Insulation tape RO Banda izolatoare
 D Isolierband F Ruban électrique
 PL Taśma elektroizolacyjna I Nastro isolante
 RUS Изолента E Cinta aislante
 CZ Izolační páska CN 绝缘胶带
 H Szigetelőszalag

EN60454-3-1-1/F-PVC/60/R-Tp
 DIELECTRIC STRENGTH / WYTRZYMAŁOŚĆ DIELEKTRYCZNA > 35 Kv / mm
 ELONGATION / WYDŁUŻENIE > 125%
 FLAME TEST / TEST OGNIOWY < 1 s
 STORE TEMPERATURE / TEMPERATURA SKŁADOWANIA +10°C ~ +40°C
 USING TEMPERATURE / TEMPERATURA UŻYTKOWANIA +5°C ~ +50°C



YATO	dimensions / wymiary	
YT-8152	12 mm x 10 m x 0.13 mm	96/384
YT-8159	15 mm x 20 m x 0.13 mm	72/288
YT-8165	19 mm x 20 m x 0.13 mm	72/288
YT-8174	25 mm x 20 m x 0.19 mm	48/192
YT-8177	50 mm x 33 m x 0.19 mm	48

YATO	dimensions / wymiary	
YT-81592	15 mm x 20 m x 0.13 mm	72/288
YT-8166	19 mm x 20 m x 0.13 mm	72/288

YATO	dimensions / wymiary	
YT-81591	15 mm x 20 m x 0.13 mm	72/288
YT-81651	19 mm x 20 m x 0.13 mm	72/288

YATO	dimensions / wymiary	
YT-81594	15 mm x 20 m x 0.13 mm	72/288
YT-81654	19 mm x 20 m x 0.13 mm	72/288



10 PCS

10 PCS

YATO	dimensions / wymiary	
YT-81593	15 mm x 20 m x 0.13 mm	72/288
YT-81655	19 mm x 20 m x 0.13 mm	72/288

YATO	dimensions / wymiary	
YT-81595	15 mm x 20 m x 0.13 mm	72/288
YT-81652	19 mm x 20 m x 0.13 mm	72/288

YATO	dimensions / wymiary	
YT-8156	12 mm x 10 m x 0.13 mm	10/40

YATO	dimensions / wymiary	
YT-8173	19 mm x 20 m x 0.13 mm	6/24

GB Tool set for electricians
D Werkzeug-Set für Elektriker
PL Zestaw narzędziowy dla elektryków
RUS Набор инструментов для электриков
CZ Sada nářadí pro elektrikáře

H Szerszámkészlet villanyszerelők
RO Trusa electrician
F Un ensemble d'outils pour les électriciens

I Set per l'elettricista
E Um conjunto de ferramentas para electricistas
CN 件电子绝缘工具组套

BMC & COLOR SLEEVE



68 PCS	1/4" 6.3mm	CrV 50BV30	CrV 6150
S2	1000 V	DYE	



1/4" (6.3 mm): 4, 4.5, 5, 5.5, 6, 7, 8, 9, 10, 11, 12, 13 mm (L=25 mm); CrV 50BV30;
140 mm; 190 mm; 3CRB; 150 mm;
160 mm; 1000 V; CrV; 160 mm; 1000 V; CrV;
3 m x 16 mm; 175 mm; 19.5 x 190 mm;
1.5 V; 9 LED; 9 mm; 19 mm x 20 mm;
1/4" (6.3 mm); (150 mm); CrV 50BV30;
1/4" (6.3 mm) x 1/4" (6.3 mm); CrV 6140; 10 g;
1.4, 2, 2.4 mm; PH00, PH0, PH1; S2;
4x75, 5.5x125, PH1x80, PH2x100 mm; 1000V; S2;
1/4" (6.3 mm): 3, 4, 5, 5.5, 6 mm (L=25 mm); AISI S2;
1/4" (6.3 mm): PH1, PH2, PH3 (L=25 mm); AISI S2;
1/4" (6.3 mm): T8, T10, T15, T20, T25, T27 (L=25 mm); AISI S2;
1/4" (6.3 mm): 2, 2.5, 3, 4, 5, 6 (L=25 mm); AISI S2;
1.5, 2, 2.5, 3, 4, 5, 6, 7, 8, 10 mm; CrV 6150



U 0-500 V	U 0-500 V	I 0-5 A	R 0-2 MΩ	⚡
h _{FE} PNP NPN		5V _{P-P}	📶	



12-250 V	50-500 Hz	LCD DISPLAY	NO BATTERY NEEDED NEE POTRZEBUJE BATERII
-------------	--------------	----------------	---



30W	230V~ 50Hz	400°C	TIP Ø 3.8x10 mm
-----	---------------	-------	--------------------

YATO	○	📦
YT-39009	1/4" (6.3 mm)	2

GB Electrical clip assortment
D Krokodil-Klemmen-Kortiment
PL Zestaw złącz elektrycznych - krokodylki
RUS Набор разъемов - крокодил
CZ Terminal alligator krokodil přichytek
H Krokodil csipesz keszlet
RO Sortiment cleme crocodil
F Assortiment pinces crocodile
I Set di perni per misure e prove
E Crocodile clip
CN 件套夹头组套



28
PCS
MIX
SIZE
KROKODIL



10 pcs / sztuk - Alligator - clip without insulation / Krokodylki niezolowane
6 pcs / sztuk - Alligator - clip insulation / Krokodylki izolowane
4 pcs / sztuk - Big charging clip insulation / Zaciski duże izolowane
6 pcs / sztuk - Mini alligator - clip / Krokodylki małe izolowane
2 pcs / sztuk - Small charging clip insulation / Zaciski małe izolowane

YATO	dimensions / wymiary (mm)	📦
YT-06870	50; 55; 60; 65; 70; 80	5/20

GB Terminal connectors
D Kabelschuhe schnellkupplung kabelklemme
PL Zestaw szybkozłącz elektrycznych
RUS Набор экспресс-клемм
CZ Kabelova rychlospojka
H Gyors csatlakozó auto
RO Conector rapid pt. auto
F Connecteur rapide
I Connettori terminali
E Conector rapido electrico
CN 件套连接片组套



50
PCS
MIX
SIZE
KROKODIL

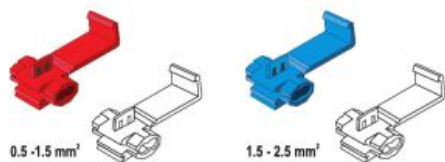

YATO	dimensions / wymiary (mm ²)	📦
YT-06868	0.5 - 1.5; 1.5 - 2.5	5/20

GB Heat-shrink tubing set
D Schrumpfschlauch - sortiment
PL Zestaw koszulek termokurczliwych
RUS Набор термоусадочных трубок
CZ Smršťovací bužířka tepelně
H Hőre zsugorodó cső szettek
RO Set tuburi termocontractabile
F Gaine thermoretractable coffret
I Tubo termoretraibile per isolare
E Surtido tubo de conexión eléctrica cable manga
CN 件套热收缩管



127
PCS
MIX
SIZE
KROKODIL
125°C
max.
600 V
max.



Ø 2.0 x 40, 2.5 x 40, 3.5 x 40, 5.0 x 40,
7.0 x 80, 10.0 x 80, 13.0 x 85 mm

YATO	dimensions / wymiary (mm ²)	📦
YT-06866		5/20

GB Car fuse assortment
 D KFZ-Sicherungs - Set
 PL Zestaw bezpieczników
 RUS Набор предохранителей

CZ Sada pojistek
 H Biztosítékészlet
 RO Set sigurante
 F Ensemble de fusible

I Kit di fusibili lamellari
 E Conjunto de fusibles
 CN 件套车用保险大插片组套

PLASTIC
 HANGING BOX



24
 PCS

MAXI

(20A, 30A, 40A, 50A, 60A, 70A, 80A, 100A) x3 PCS

YATO	
YT-83140	24

7



92
 PCS

STANDARD

FUSE
 PULLER
 CHWYTAK

(5A, 10A, 15A, 20A, 25A, 30A) x15 PCS /
 VOLTAGE TESTER 6-24V / TESTER

YATO	
YT-83142	24



97
 PCS

STANDARD

FUSE
 PULLER
 CHWYTAK

(3A, 5A, 7.5A, 10A, 15A, 20A, 25A, 30A) x12 PCS

YATO	
YT-83141	24



121
 PCS

MINI

FUSE
 PULLER
 CHWYTAK

(5A, 10A, 15A, 20A, 25A, 30A) x20 PCS

YATO	
YT-83143	24

Memo

8

**Hammers, chisels,
punches & axes**

**Młotki, dłuta,
przecinaki i siekiery**



Machinist hammers Młotki ślusarskie	
.....	132

Ball pein hammers & sets Młotki blacharskie i zestawy	
.....	134

Stoning hammers Młotki kamieniarskie	
.....	132

Chisels, cold chisels & punches Dłuta, przecinaki i przebijaki	
.....	135-138

Hammers with tubular steel handle Młotki z trzonkiem rurowym	
.....	133

Wood chisels & sets Dłuta stolarskie i zestawy.....	135
Cold chisels Przecinaki.....	135
Punches Przebijaki.....	135
Pin punches Wybijaki.....	136
Punches Punktaki.....	136
Cold chisel & punch sets Zestawy przecinaków i punktaków.....	136

Claw hammers Młotki szewskie.....	133
Roofing hammers Młotki ciesielskie.....	133
Mason's hammers Młotki murarskie.....	133
Plasterer's hatchets Toporki tynkarskie.....	133

Wrecking bars Łomy	
.....	138

Fully drop forged hammers Młotki monolityczne kute	
.....	133

Axes Siekiery	
.....	139

Claw hammers Młotki szewskie.....	133
Roofing hammers Młotki ciesielskie.....	133
Mason's hammers Młotki murarskie.....	133

Adzes Ciosła	
.....	139

Rubber mallets Młotki gumowe	
.....	134

Dead blow hammers Młotki bezodrzutowe	
.....	134

GB Machinist hammer CZ Zámečnické kladívko I Martello da aggiustatore
 D Schlosserhammer H Vaskalapács E Martillo
 PL Miotek ślusarski RO Ciocan de lăcătuşerie CN 钳工锤
 RUS Молоток слесарный F Marteau serrurier

DIN
1041

Safety protection steel ring
Klin pierścieniowy zapewniający bezpieczeństwo

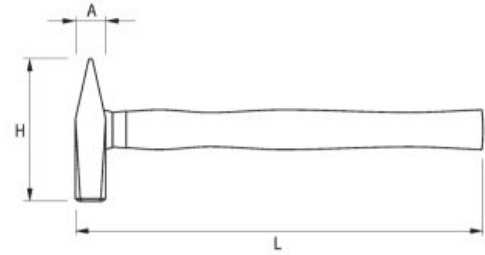

YATO	m (g)	L (mm)	A (mm)	H (mm)	
YT-4491	100	260	15	80	12/120
YT-4492	200	280	20	93	6/60
YT-4493	300	300	21	103	6/60
YT-4494	400	310	23	111	6/48
YT-4495	500	320	26	118	6/36

YATO	m (g)	L (mm)	A (mm)	H (mm)	
YT-4496	600	330	28	119	6/36
YT-4497	800	350	31	125	6/24
YT-4498	1000	360	35	132	6/24
YT-4499	1500	380	40	143	6/12
YT-4500	2000	400	45	153	6/12

8

Safety protection steel ring
Klin pierścieniowy zapewniający bezpieczeństwo

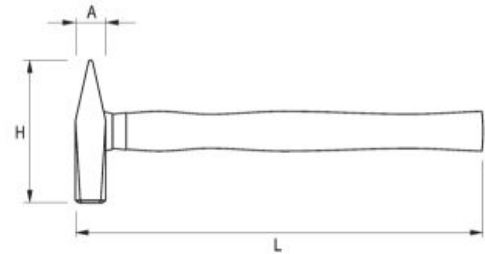

YATO	m (g)	L (mm)	A (mm)	H (mm)	
YT-4501	100	260	15	82	12/120
YT-4502	200	280	19	95	6/60
YT-4503	300	300	23	105	6/60
YT-4504	400	310	25	112	6/48
YT-4505	500	320	27	118	6/36

YATO	m (g)	L (mm)	A (mm)	H (mm)	
YT-4506	600	330	29	122	6/36
YT-4507	800	350	33	135	6/24
YT-4508	1000	360	36	135	6/24
YT-4509	1500	380	42	145	6/12
YT-4510	2000	400	47	155	6/12

GB Safety stoning hammer H Kőtörő kalapács I Martello da aggiustatore
 D Fäustel RO Ciocan pt. zidarie E Martillo
 PL Miotek kamieniarski F Marteau de tailleur de pierres CN 石工锤
 RUS Молоток каменщика
 CZ Palička kovová

DIN
6475

Safety protection steel ring
Klin pierścieniowy zapewniający bezpieczeństwo

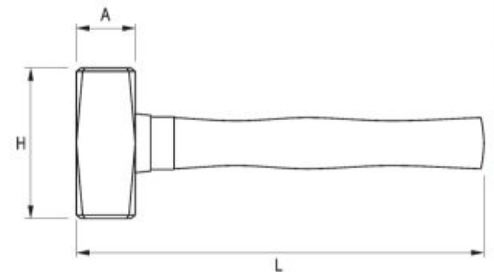

YATO	m (g)	L (mm)	A (mm)	H (mm)	
YT-4550	1000	260	40	95	6/24
YT-4551	1250	260	43	100	6/24

YATO	m (g)	L (mm)	A (mm)	H (mm)	
YT-4552	1500	280	45	110	6/12
YT-4553	2000	300	50	120	6/12

GB Claw hammer
D Schusterhammer
PL Młotek szewski
RUS Молоток гвоздодёр
CZ Ševcovské kladívko
H Cipész kalapács

RO Ciocan de cizmărie
F Marteau de cordonnier
I Martello calzolaio
E Martillo sacador
CN 羊角锤



- high quality steel handle
- forged carbon steel head hardened and tempered
- stalowy trzonek
- bijak ze stali węglowej, kuty, ulepszony cieplnie

YATO	m (g)	L (mm)	A (mm)	H (mm)	
YT-4560	450	318	30	130	6/24

GB Roofing hammer
D Latthammer Geschmiedet
PL Młotek ciesielski
RUS Молоток жестящика
CZ Tesařské kladívko

H Ácskalapács
RO Ciocan de dulgherie
F Marteau de charpentier

I Martello per carpentiere
E Martillo techumbre
CN 独角锤



- high quality steel handle
- forged carbon steel head hardened and tempered
- stalowy trzonek
- bijak ze stali węglowej, kuty, ulepszony cieplnie

YATO	m (g)	L (mm)	A (mm)	H (mm)	
YT-4561	600	318	25x25	165	6/24

GB Mason's hammer, type B
D Berliner Mauerhammer
PL Młotek murarski berliński
RUS Молоток каменщика широкий

F Marteau de maçon
I Martello muratore tipo Berlin
E Martillo de albañil de Berlín
CN B型泥工锤



- high quality steel handle
- forged carbon steel head hardened and tempered
- stalowy trzonek
- bijak ze stali węglowej, kuty, ulepszony cieplnie

YATO	m (g)	L (mm)	A (mm)	H (mm)	
YT-4562	600	315	24x23	200	6/24

GB Mason's hammer, type R
D Mauerhammer Rheinische Form
PL Młotek murarski reński
RUS Молоток каменщика узкий
CZ Zednické kladívko renské
H Kőműves kalapács, rajnai típus

RO Ciocan de zidărie (tip ren)
F Marteau de maçon
I Martello muratore tipo rin
E Martillo de albañil de Rin
CN R型泥工锤



- high quality steel handle
- forged carbon steel head hardened and tempered
- stalowy trzonek
- bijak ze stali węglowej, kuty, ulepszony cieplnie

YATO	m (g)	L (mm)	A (mm)	H (mm)	
YT-4563	600	315	23x23	170	6/24

GB Plasterer's hatchet
D Gipserbeil
PL Toporek tynkarski
RUS Топор штукатурный



- high quality steel handle
- forged carbon steel head hardened and tempered
- stalowy trzonek
- bijak ze stali węglowej, kuty, ulepszony cieplnie

YATO	m (g)	L (mm)	A (mm)	H (mm)	
YT-4564	600	315	25x20	175	6/24

GB Claw hammer
D Schusterhammer
PL Młotek szewski
RUS Молоток гвоздодёр
CZ Ševcovské kladívko
H Cipész kalapács



- high quality steel handle
- forged carbon steel head hardened and tempered
- stalowy trzonek
- bijak ze stali węglowej, kuty, ulepszony cieplnie

YATO	m (g)	L (mm)	A (mm)	H (mm)	
YT-4570	450	315	30	130	6/24

GB Roofing hammer
D Latthammer Geschmiedet
PL Młotek ciesielski
RUS Молоток жестящика
CZ Tesařské kladívko
H Ácskalapács
RO Ciocan de dulgherie

F Marteau de charpentier
I Martello calzolaio
E Martillo techumbre
CN 连体羊角锤



- high quality steel handle
- forged carbon steel head hardened and tempered
- stalowy trzonek
- bijak ze stali węglowej, kuty, ulepszony cieplnie

YATO	m (g)	L (mm)	A (mm)	H (mm)	
YT-4571	600	331	25x25	165	6/24

GB Mason's hammer, type R
D Mauerhammer Rheinische Form
PL Młotek murarski reński
RUS Молоток каменщика узкий
CZ Zednické kladívko renské
H Kőműves kalapács, rajnai típus

RO Ciocan de zidărie (tip ren)
F Marteau de maçon
I Martello muratore tipo rin
E Martillo de albañil de Rin
CN 连体R型泥工锤



- high quality steel handle
- forged carbon steel head hardened and tempered
- stalowy trzonek
- bijak ze stali węglowej, kuty, ulepszony cieplnie

YATO	m (g)	L (mm)	A (mm)	H (mm)	
YT-4573	600	382	25x24	158	6/24

- GB Rubber mallet with fibreglass, TPR handle
- D Gummihammer mit Fiberglasstiel
- PL Młotek gumowy z trzonkiem z włókna szklanego
- RUS Киянка резиновая со стеклопластиковой ручкой
- CZ Pryžové kladívko
- H Gumikalapács
- RO Ciocan de cauciuc
- F Maillet caoutchouc
- I Martello mazzuola in gomma
- E Mazo de goma
- CN 纤维柄橡胶锤



YATO	m (g)	L (mm)	Ø (mm)	H (mm)	Box
YT-4594	440	340	50	87.5	6/36

- GB Rubber mallet with wooden handle
- D Gummihammer mit Holzstiel
- PL Młotek gumowy z drewnianym trzonkiem
- RUS Молоток резиновый
- CZ Pryžové kladívko
- H Gumikalapács
- RO Ciocan de cauciuc
- F Maillet caoutchouc
- I Martello mazzuola in gomma
- E Mazo de goma
- CN 木柄橡胶锤



YATO	m (g)	L (mm)	Ø (mm)	H (mm)	Box
YT-4600	230	259	44	71.0	12/48
YT-4601	340	291	49	79.5	12/48
YT-4602	370	300	50	87.5	6/36
YT-4603	580	341	58	96.0	6/36
YT-4604	780	341	63	117.0	6/36
YT-4605	980	345	72	122.0	6/24

- GB Dead blow mallet
- D Rückschlagsfreier Schonhammer
- PL Młotek bezodrzutowy
- RUS Молоток безинерционный
- CZ Palička nárazová plněná celogumová
- H Visszarúgás mentes gumikalapács
- RO Ciocan cu absorbție
- F Maillet sans recul
- I Martello morto colpo
- E Martillo sin reacción
- CN 防震无回弹橡胶锤



PU



YATO	m (g)	L (mm)	Ø (mm)	H (mm)	Box
YT-4620	740	300	44.5	100.0	4/24
YT-4622	900	336	53.5	100.0	4/24
YT-4623	1300	350	59.0	118.5	3/12

- GB Dead blow mallet
- D Rückschlagsfreier Schonhammer
- PL Młotek bezodrzutowy
- RUS Молоток безинерционный
- CZ Palička nárazová plněná celogumová
- H Visszarúgás mentes gumikalapács
- RO Ciocan cu absorbție
- F Maillet sans recul
- I Martello morto colpo
- E Martillo sin reacción
- CN 防震无回弹橡胶锤



FIBREGLASS
WŁÓKNO
SZKLANE



YATO	m (g)	L (mm)	dimensions / wymiary (mm)	Box
YT-46270	2.4	490	70x70x140	2/6
YT-46273	5.5	900	105x105x180	2

- GB Dead blow mallet
- D Rückschlagsfreier Schonhammer
- PL Młotek bezodrzutowy
- RUS Молоток безинерционный
- CZ Palička nárazová plněná celogumová
- H Visszarúgás mentes gumikalapács
- RO Ciocan cu absorbție
- F Maillet sans recul
- I Martello morto colpo
- E Martillo sin reacción
- CN 尼龙安装锤

PU



YATO	m (g)	L (mm)	Ø (mm)	H (mm)	Box
YT-4624	265	318	30.0	94	10/40
YT-4625	430	350	40.0	100	6/36
YT-4626	490	348	45.0	110	6/36

- GB PU & nylon heads mallet
- D Schonhammer mit PU & Nylon-Schlagkopf
- PL Młotek blacharski
- RUS Молоток рихтовочный
- CZ Palička klempířská
- H Vaskalapács
- RO Ciocan tinichigerie cap PU / nylon
- F Marteau spécial en PU / nylon
- I Martello per lamiera
- E Martillo chapista
- CN 木柄安装锤

PU

NYLON



YATO	m (g)	L (mm)	Ø (mm)	H (mm)	Box
YT-4630	150	250	22	75	6/48
YT-4631	250	280	28	85	6/36
YT-4632	340	315	35	95	6/36
YT-4633	660	350	45	105	6/24
YT-4634	1340	380	60	132	4/16

- GB Auto body fender set
- D Karosserie-Ausbeulsatz
- PL Komplet młotków blacharskich
- RUS Молотки рихтовочные
- CZ Souprava klempířských kladívek
- H Bádogos kalapács készlet
- RO Set de ciocane de tablă
- F Set pour carrossier
- I Martello per lamiera
- E Juego de mazos de hojalatero
- CN 钣金工具组套

7 PCS
DROP FORGED
KUTE

GENUINE
HICKORY



BMC
& COLOR SLEEVE



YATO	m (g)	Box
YT-4590	4900	4

- GB Ball pein hammer
- D Ausbeulhammer
- PL Młotek blacharski
- RUS Молоток рихтовочный
- CZ Klempířské kladívko
- H Bádogos kalapács
- RO Ciocan pt. tabla
- F Marteau à panne ronde

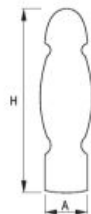

YATO	m (g)	L (mm)	A (mm)	H (mm)	Box
YT-4515	225	280	26	80	6/36
YT-4516	450	315	34	100	6/24
YT-4518	900	380	40	125	6/12

- GB Ball pein hammer
- D Ausbeulhammer
- PL Młotek blacharski
- RUS Молоток рихтовочный
- CZ Klempířské kladívko
- H Bádogos kalapács
- RO Ciocan pt. tabla
- F Marteau à panne ronde



YATO	m (g)	L (mm)	A (mm)	H (mm)	Box
YT-4519	225	295	26	80	6/36
YT-4520	450	335	35	100	6/24
YT-4521	680	360	36	115	6/12
YT-4522	900	380	40	125	6/12

- GB Wood chisel
D Stechbeitel
PL Dłuto stolarskie
RUS Долото
CZ Rezbářské dláto
H Asztalos véső
- RO Daltă de tâmplărie
F Ciseau
I Scalpello
per falegname
E Cíncel para madera
CN 木工凿

DOUBLE
BLISTER



CrV
60

HRC
56-62



YATO	size / rozmiar (mm)	
YT-6241	8	10/60
YT-6242	10	10/60
YT-6243	12	10/60
YT-6244	14	10/60
YT-6245	15	10/60
YT-6246	16	10/60
YT-6247	18	10/60

YATO	size / rozmiar (mm)	
YT-6248	20	10/60
YT-6249	22	10/60
YT-6251	25	10/60
YT-6253	28	10/60
YT-6256	35	10/60
YT-6258	38	10/60

- GB Chisel set
D Meißelsatz
PL Zestaw dłut
RUS Набор зубил
- CZ Sada dlát
H Hidegvágó készlet
RO Set de dălți
F Set de ciseaux à bois
- I Set scalpelli
E Juego de cinceles
CN 木工凿组套

4
PCS

10 16
20 25
mm

CrV
60

HRC
58-60



DOUBLE
BLISTER

YATO	
YT-6260	5/20

- GB Chisel set
D Meißelsatz
PL Zestaw dłut
RUS Набор зубил
- CZ Sada dlát
H Hidegvágó készlet
RO Set de dălți
F Set de ciseaux à bois
- I Set scalpelli
E Juego de cinceles
CN 木工凿组套

3
PCS

CrV

16 25
32 mm

PLASTIC
HANGER



YATO	
YT-6280	10/30

- GB Chisel set
D Meißelsatz
PL Zestaw dłut
RUS Набор зубил
- CZ Sada dlát
H Hidegvágó készlet
RO Set de dălți
F Set de ciseaux à bois
- I Set scalpelli
E Juego de cinceles
CN 木工凿组套

4
PCS

CrV

10 12
16 20
mm

PLASTIC
HANGER

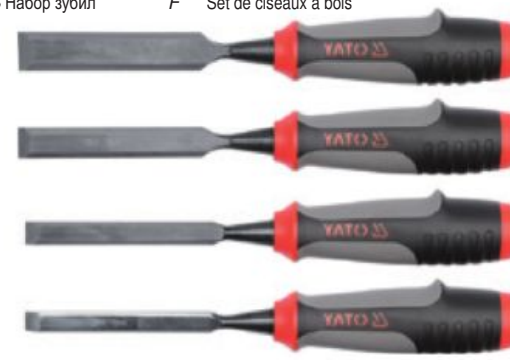

YATO	
YT-6281	6/24

- GB Cold chisel with protection
D Schlitzmeißel mit Handschutz
PL Przecinak z osłoną
RUS Зубило с протектором
CZ Plochý sekáč (z krytem)
H Hidegvágó, lapos (védőfejjel)
- RO Daltă - tăietor
plată (cu apărătoare)
F Burin
I Scalpello con protezione
E Cíncel plano (con protector)
CN 石工凿

25x300
mm

CrV



PLASTIC
HANGER

YATO	L (mm)	
YT-4700	300	4/24

- GB Punch with protection
D Spitzmeißel mit Handschutz
PL Przecbijak z osłoną
RUS Скапель с пластмассовой ручкой
CZ Zednický průbojník (z krytem)
H Falvésző (védőfejjel)
RO Dorn (perforator)
pt. perete (cu apărătoare)
- F Perçoir
I Scalpello a punta con protezione
E Cíncel de cerrajería con protector
CN 水泥尖凿

300
mm

CrV



PLASTIC
HANGER

YATO	L (mm)	
YT-4705	300	4/24

- GB Chisel and punch set
D Trennmeißel- und Durchtreiber-Satz
PL Zestaw przecinaków i punktaków
RUS Зубила и пробойники с протектором
CZ Sekáče a průbojníky
H Véső és lyukasztó készlet
RO Set dălți de impact
F Kit de burins et perçoirs
I Scalpelli e bulino
E Juego de cinceles de acero templado y punzones
CN 冲凿组套



180
mm

6
PCS

CENTER PUNCH
PUNKTAK
Ø 3 mm

PIN PUNCH
WYBLIAK
Ø 3 mm
Ø 4 mm

CHISEL
PRZECINAK
12 mm
16 mm
19 mm

CrV

PLASTIC
HANGER



YATO	L (mm)	
YT-4710	180	10/20

- GB Cold chisel
D Flach meißel
PL Przęcinak płaski
RUS Зубило плоское
CZ Sekáč plochý
H Laposvágó

- RO Dalta lata
F Burin
I Scalpello a punta
E Tajadera en frío
CN 凿子



YATO	L (mm)	chisel width / szerokość przycinaka (mm)	
YT-47147	142	10.0	20/120
YT-47148	152	12.5	20/120
YT-47149	172	16.0	20/120

- GB Taper punch
D Durchtreiber
PL Wybijałk równoległy
RUS Пробойник конусный
CZ Průbojník
H Lyukasztó

- RO Dorn conic
F Percuteur
I Scalpello a punta
E Retacador de cono
CN 冲子



YATO	L (mm)	pin diameter / średnica grotu (mm)	
YT-47141	150	1.5	20/120
YT-47142	150	3.0	20/120
YT-47143	150	4.0	20/120
YT-47144	150	5.0	20/120
YT-47145	150	6.0	20/120
YT-47146	150	8.0	20/120

- GB Taper punch
D Durchtreiber
PL Dobijak stożkowy
RUS Пробойник конусный
CZ Průbojník
H Lyukasztó
RO Dorn conic

- F Matoir
I Scalpello a punta
E Retacador de cono
CN 冲子



YATO	L (mm)	taper punch / średnica wybijała stożkowego (mm)	
YT-47152	140	2.0	20/120

- GB Center punch
D Körner
PL Punktak
RUS Пробойник - керн
CZ Důlčik
H Pontozó
RO Punctator

- F Pointeau
I Punzoni
E Retacador - punzón centrador
CN 冲子



YATO	L (mm)	center punch / średnica punktaka (mm)	
YT-47150	100	6.0	20/120
YT-47151	112	8.0	20/120

- GB Pin punch set
D Splintentreiber Satz
PL Zestaw wybijań
RUS Пробойник булавочный- набор
CZ Sada vyrážeců
H Csapszegkiütő készlet

- RO Set de dornuri
F Set de perceuteurs
I Set scalpelli
E Juego de punzones
CN 销式冲子组套

SLIDING CARD



YATO	L (mm)	
YT-47121	150	6/24

- GB Chisel set
D Flachmeißelsatz
PL Zestaw przycinaków
RUS Зубила в наборе
CZ Sekáče
H Hidegvágó

- RO Set dalți zidarie
F Set de burins
I Set scalpelli
E Cinceles
CN 冲凿组套

PLASTIC HANGER



YATO		
YT-4711		6/24

- GB Chisel and punch set
D Trennmeißel- und Durchtreiber-Satz
PL Zestaw przycinaków i punktaków
RUS Зубила, керны и пробойники в наборе
CZ Sekáče a průbojníky
H Véső és lyukasztó készlet
RO Set dalți de impact
F Set de burins et pointeaux
I Set scalpelli
E Juego de cinceles de acero templado y punzones
CN 冲凿组套

PLASTIC HANGER

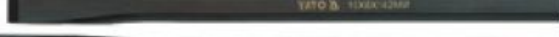
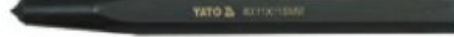
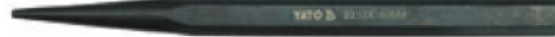
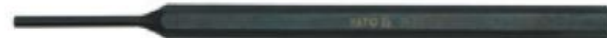

YATO		
YT-4712		6/24

- GB Mini cold chisel and punch set
 D Trennmeißel- und Durchtreiber-Satz
 PL Zestaw wybijaków i przecinak
 RUS Зубила и керны в наборе
 CZ Sekáče a průbojníky
 H Véső és lyukasztó készlet
 RO Set dalti de impact
 F Set de burins et perceurs mini
 I Set scalpelli e bulini
 E Juego de cinceles de acero templado y punzones
 CN 迷你冲凿组套

PLASTIC HANGER



YATO YT-4713 10/60

- GB Chisel and punch set
 D Trennmeißel- und Durchtreiber-Satz
 PL Zestaw przecinaków i punktaków
 RUS Зубила, керны и пробойники в наборе
 CZ Sekáče a průbojníky
 H Véső és lyukasztó készlet
 RO Set dalti de impact

- F Set de burins et pointeaux
 I Set scalpelli
 E Juego de cinceles de acero templado y punzones
 CN 冲凿组套



PLASTIC HANGER



YATO YT-4714 10/20

- GB Sliding hammer with 2" flat chisel tip
 D Flachmeißel mit gleithammer
 PL Przecinak ręczny z bijakiem ślizgowym
 RUS Зубило ударное со скользящим молотком

- CZ Posuvné kladivo
 H Csúszókalapácsos
 RO Dalta cu ciocan culisant
 F Marteau coulissant

- I Scalpello con martello scorrevole
 E Martillo deslizante cinceles
 CN 钣金滑锤



WHITE CARTON BOX & COLOR LABEL

YATO YT-46880 L (mm) 680 6

- GB Pin punch
 D Splintentreiber
 PL Wybijak
 RUS Пробойник булавочный
 CZ Vyrážeč
 H Csapszegkiütő

- RO Dorn cilindric
 F Percuteur
 I Punzoni
 E Punzón expulsador
 CN 销式冲子



YATO YT-4690 L (mm) 150 20/120

- GB Taper punch
 D Durchtreiber
 PL Dobijak stożkowy
 RUS Пробойник конусный
 CZ Průbojník
 H Lyukasztó
 RO Dorn conic

- F Mator
 I Punzoni
 E Retacador de cono
 CN 冲孔器



YATO YT-4691 L (mm) 120 20/120

- GB Center punch
 D Körner
 PL Punktak
 RUS Пробойник - керн
 CZ Důlčik
 H Pontozó

- RO Punctor
 F Pointeau
 I Punzoni
 E Retacador - punzón centrador
 CN 冲子



YATO YT-4692 L (mm) 120 20/120

- GB Cold chisel
 D Flach Meißel
 PL Przecinak płaski
 RUS Зубило плоское
 CZ Sekáč plochý
 H Laposvágó

- RO Dalta lata
 F Burin plat
 I Scalpello piatto
 E Tajadera en frío
 CN 扁铲



YATO YT-4693 L (mm) 130 20/120

GB Cape chisel
D Kreuzmeissel
PL Przecinak krzyżowy
RUS Зубило „лика”
CZ Sekáč křížový
H Keresztvágó
RO Dalta ascuțita

F Burin
I Scalpello rettangolare
E Tajadera rectangular
CN 钎头

SLIDING CARD



130 mm

CrV 60

CAPE CHISEL
PRZECINAK
PROSTOKĄTNY
5.5 mm



YATO	L (mm)	
YT-4694	130	20/120

GB Chisel and punch set
D Trennmeissel- und Durchtreiber-Satz
PL Zestaw przecinaków i punktaków
RUS Зубила и керны в наборе
CZ Sekáče a průbojníky
H Véső és lyukasztó készlet
RO Set dalți de impact
F Set de burins
I Set scalpelli e bulino
E Juego de cinceles de acero templado y punzones
CN 样冲组套

SLIDING CARD



5 PCS

CrV 60

CHISEL
PRZECINAK
12x130 mm

CENTER PUNCH
PUNKTAK
3.8x120 mm

CrV 60

PIN PUNCH
WYBLAJAK
=3.8x150 mm

TAPER PUNCH
WYBLAJAK
STOŻOWY
=3.3x120 mm

CAPE CHISEL
PRZECINAK
PROSTOKĄTNY
5.5x130 mm



YATO		
YT-4695		6/24

GB Hexagonal wrecking bar
D Brechstange
PL Łom sześciokątny
RUS Лом-гвоздодёр шестигранный
CZ Šestiúhľé páčidlo
H Hatszögű feszítővas
RO Ranga pt. scos cuie
F Pied-de-biche manche hexagonal
I Mazza di ferro
E Palanqueta
CN 撬棒

DROP FORGED KUTE



YATO	size / rozmiar (mm)	
YT-46800	400x18	6/12
YT-46801	450x18	6/12
YT-46802	600x18	6/12
YT-46803	750x18	6/12
YT-46804	900x18	5/10

GB Hexagonal wrecking bar
D Brechstange
PL Łom sześciokątny
RUS Лом-гвоздодёр шестигранный
CZ Šestiúhľé páčidlo
H Hatszögű feszítővas
RO Ranga pt. scos cuie
F Pied-de-biche manche hexagonal
I Mazza di ferro
E Palanqueta
CN 撬棒

DROP FORGED KUTE



YATO	size / rozmiar (mm)	
YT-46831	400x16	6/24
YT-46832	600x20	6/12
YT-46833	800x22	6/12
YT-46834	1000x22	6
YT-46835	1200x25	6
YT-46836	1500x25	6

GB Profiled wrecking bar
D Nageleisen
PL Łom profilowany
RUS Лом-гвоздодёр
CZ Páčidlo
H Szögkíhúzó
RO Ranga pt. scos cuie
F Pied-de-biche profilé
I Mazza di ferro
E Palanqueta
CN 撬棒

DROP FORGED KUTE



YATO	size / rozmiar (mm)	
YT-46810	350x22x13	6/12
YT-46811	450x30x17	6/12
YT-46812	600x30x17	4/8
YT-46813	750x30x17	4/8
YT-46814	900x30x17	3/6

GB Flat wrecking bar
D Nageleisen spitze
PL Łom płaski
RUS Лом плоский
CZ Páčidlo ploché
H Lapos feszítővas
RO Ranga plata
F Pied-de-biche plat
I Mazza di ferro
E Palanqueta
CN 撬棒

DROP FORGED KUTE



YATO	size / rozmiar (mm)	
YT-46820	300x35x6	10/30
YT-46821	380x35x6	10/20
YT-46822	450x35x6	10/20
YT-46823	600x35x6	10/20

GB Precision claw bar
D Brecheisen
PL Łom wąski
RUS Лом
CZ Sochor
H Emelőrúd
RO Rangă
F Pied de biche
I Piede di porco
E Palanca
CN 撬棒



DROP FORGED KUTE

YATO	size / rozmiar (mm)	
YT-46750	300x16x13	6/24

GB Go-through pry bar set
D Nageleisensatz
PL Zestaw łomów

RUS Набор ломов
CZ Sada mini páčidel
H Szöghúzó készlet

RO Set leviere
F Set de pieds-de-biche
I Set mazza di ferro

E Juego de palancas de hierro
CN 穿心撬棒组套

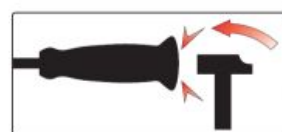

4 PCS

- 198x6x6 mm, 110 g
- 304x10x10 mm, 292 g
- 456x10x10 mm, 479 g
- 608x12x12 mm, 745 g

DOUBLE BLISTER

YATO		
YT-4730		3/6

- | | | | | | | | |
|----|----------|-----|----------|----|--------|----|-------|
| GB | Axe | RUS | Tonop | RO | Secure | E | Hacha |
| D | Beil | CZ | Sekerka | F | Hache | CN | 把斧 |
| PL | Siekiera | H | Szekerce | I | Ascia | | |

GENUINE
HICKORY

Memo

Timber wedge
and steel ring
Drewniany klin
ze stalowym
pierscieniem



Genuine hickory shaft
Trzonek z hikory

Forged carbon steel head hardened and tempered
Głowica z kutej stali węglowej, hartowana i utwardzona

DIN
5131
7294

YATO	m (g)	L (mm)	DIN	
YT-8001	600	360	5131	24
YT-8002	800	380	5131	20
YT-8003	1000	430	5131	12
YT-8004	1250	710	7294	12
YT-8005	1400	710	7294	12
YT-8006	1600	810	7294	12

Timber wedge
and steel ring
Drewniany klin
ze stalowym
pierscieniem



Genuine hickory shaft
Trzonek z hikory

Forged carbon steel head hardened and tempered
Głowica z kutej stali węglowej, hartowana i utwardzona

YATO	m (g)	L (mm)	
YT-8011	1000	515	6
YT-8012	2000	820	6

- | | |
|-----|-------------------------|
| GB | Adze flat type |
| D | Flachdaxel |
| PL | Ciosło płaskie |
| RUS | Тесло плоское |
| CZ | Sekyrka |
| H | Szekerce |
| RO | Tesla |
| F | Hache d'artisans |
| I | Ascia tipo piatto |
| E | Destral
de artesanos |
| CN | 扁斧 |



YATO	
YT-80130	4/24

8

Memo

9

Clamps, vices & holders Ściski, imadła i wsporniki



Clamps
Ściski

142-143



Magnetic holders
Wsporniki magnetyczne

144



Vices
Imadła

143



- GB F-clamp H Asztalos szorító I Morsetto da falegname
 D Schraubzwinde RO Menghină pt. tâmplărie E Tornillo de apriete
 PL Ścisk stolarski F Presse à serrage pour CN F夹钳
 RUS Струбцина menuisier
 CZ Truhlářské upínadlo



QUICK
ADJUSTMENT
SZYBKĄ
REGULACJĄ

QUICK
ADJUSTMENT
SZYBKĄ
REGULACJĄ

YATO	L (mm)	
YT-6401	160x80	10/30
YT-6402	200x80	10/30
YT-6403	250x80	10/30
YT-6404	300x80	10/30
YT-6405	450x80	10/20
YT-6406	600x80	10/20
YT-6407	400x120	10
YT-6408	500x120	10
YT-6409	600x120	10
YT-6410	900x120	5

YATO	L (mm)	
YT-64111	250x80	4/24
YT-64112	300x80	4/24
YT-64113	450x80	4/24
YT-6412	300x120	10
YT-6413	400x120	10
YT-6414	500x120	5
YT-6415	600x120	5
YT-6416	900x120	5
YT-6417	1050x120	5

YATO	L (mm)	
YT-6440	100x50	12/60
YT-6441	150x50	12/48
YT-6442	200x50	12/48
YT-6443	250x50	12/48
YT-6444	300x50	12/48
YT-6445	200x80	10/20
YT-6446	250x80	10/20
YT-6447	300x80	10/20
YT-6448	500x80	10/20
YT-6449	300x120	10
YT-6450	500x120	10
YT-6451	800x120	6
YT-6452	1000x120	6
YT-6453	1200x120	6
YT-6454	1500x120	6

- GB Bar clamp ratchet D Lenkerklemmung Ratsche
 PL Ścisk stolarski zapadkowy RUS Струбцина
 бистрофиксируемая CZ Svěrka s ráčnou
 H Băr bilincis racsnis RO Presă tip „F” cu clichet
 F Bar pince a cliquet I Bar morsetto a cricchetto
 E Barra de mordaza de trinquete
 CN 棘轮F夹



- GB Spring clamp D Federklemme
 PL Ścisk sprężynowy RUS Струбцина
 CZ Pružinové upínadlo H Rugós szorító
 RO Cleste presa pt. lemn F Pince de serrage
 I Morsetto a molla E Pinza
 CN 弹簧夹



YATO	L (mm)	max. jaws range / max. zasięg szczęk (mm)	max. jaws depth / max. głębokość szczęk (mm)	
YT-64270	100	42	44	24/240
YT-64271	150	55	68	12/120
YT-64272	200	79	91	10/100

- GB Insulated spring clamp D Federklemme vollisoliert
 PL Ścisk sprężynowy izolowany RUS Струбцина изолированная
 CZ Pružinové upínadlo izolované H Rugós szorító
 RO Cleste presa pt. lemn izolat F Pince de serrage isolée
 I Pinza di bloccaggio isolate E Pinza aislante
 CN 弹簧夹



1000V
VDE CERTIFICATE
EN 60900:2012

YATO	L (mm)	
YT-63951	200x100	2/12
YT-63952	250x100	2/12
YT-63953	300x100	2/12
YT-63954	400x100	2/6
YT-63955	500x120	2/4
YT-63956	600x120	2/4
YT-63957	800x120	2/4
YT-63958	1000x120	2

YATO	working capacity / zakres pracy (mm)	L (mm)	
YT-21190	2-20	150	5/40

150 mm
CrV
1000 V
D'E

POLYBAG



GB C-Clamp / Morsetto tipo „C”
D C-Schraubzwinge / E Tornillo tipo „C”
PL Ścisk typu „C” / RO Menghina tip „C”
RUS Струбцина типа „C” / F Serre-joint



DROP FORGED KUTE

YATO	size / rozmiar (mm)	force pressure / siła nacisku (kg)	
YT-6420	50	1500	6/30
YT-6421	75	1950	6/18
YT-6422	100	2980	6/12
YT-6423	150	3200	6/12
YT-6424	200	3600	6

YATO	size / rozmiar (mm)	force pressure / siła nacisku (kg)	
YT-64250	25	120	100
YT-64251	50	200	50
YT-64252	75	280	30
YT-64253	100	350	30
YT-64254	125	390	18
YT-64255	150	450	12
YT-64256	200	500	10
YT-64257	250	540	5
YT-64258	300	600	5

GB Swivel base bench vice
D Drehbare Schraubstock
PL Imadło ślusarskie obrotowe
RUS Тиски слесарные поворотные
CZ Zámečnický svěrák otáčivě
H Satu, lakatos forgó
RO Menghine rotative
F Étau rotatif de serrurier
I Morsa a cerniera
E Tornillo de apriete giratorio
CN 台虎钳

COLOR BOX



- anvil and changeable jaws made of hardened steel
- kowadełko i wymienne szczęki z hartowanej stali

YATO	jaws width / szerokość szczęk (mm)	weight / waga (kg)	
YT-6501	100	7	2
YT-6502	125	10	2
YT-6503	150	15	1
YT-65048	150	19	1
YT-6504	200	21	1
YT-65049	200	29.5	1

GB Swivel base bench vice
D Drehbare Schraubstock
PL Imadło ślusarskie obrotowe
RUS Тиски слесарные поворотные
CZ Zámečnický svěrák otáčivě
H Satu, lakatos forgó
RO Menghine rotative
F Étau rotatif de serrurier
I Morsa a cerniera
E Tornillo de apriete giratorio
CN 台虎钳

COLOR BOX



- anvil and changeable jaws made of hardened steel
- kowadełko i wymienne szczęki z hartowanej stali



YATO	jaws width / szerokość szczęk (mm)	jaws range / rozstaw szczęk (mm)	weight / waga (kg)	
YT-6505	100	100	10	1

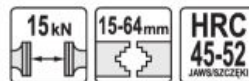

YATO	jaws width / szerokość szczęk (mm)	jaws range / rozstaw szczęk (mm)	weight / waga (kg)	
YT-6506	125	125	20	1

GB Hinged pipe vice
D Rohrschraubstock
PL Imadło zaciskowe do rur
RUS Тиски для труб
CZ Upinací svěrák na trubky
H Satu, csőszorító
RO Menghină pt. țevi
F Étau de serrage à tuyaux
I Morsa stringi tubo
E Tornillo de apriete para tubos
CN 管子台虎钳



S55C

COLOR BOX



YATO	Ø (mm)	
YT-6510	60	4
YT-6511	76	2
YT-6512	90	2
YT-6513	110	1

- GB Adjustable angle welding magnet
- D Verstellbarer Magnet-Werkstückhalter
- PL Wspornik magnetyczny spawalniczy regulowany
- RUS Регулируемый магнит заварки угла
- CZ Polohovací magnetický držák ke svařování
- H Állítható, mágneses, hegesztő támasz
- RO Dispozitiv magnetic reglabil pt. sudura
- F Support magnétique de soudure
- I Supporto della saldatura magnetico
- E Soporte magnético de soldadura, ajustable
- CN 焊接磁铁



DOUBLE BLISTER



YATO	(kg)	mm	
YT-0862	2x22.5	85x65x22	6

- GB Magnetic welding holder
- D Magnet-Werkstückhalter
- PL Kątownik magnetyczny spawalniczy
- RUS Магнитная струбцина заварки

- CZ Magnetický uhelník ke svařování
- H Mágneses, hegesztő szögvas
- RO Dispozitiv magnetic fixare pt. sudura
- F Support magnétique de soudure

- I Angolo magnetico da saldatura
- E Escuadra magnética de soldadura
- CN 焊接磁铁

DOUBLE BLISTER



YATO	(kg)	mm	
YT-0863	11.5	82x120x13	6/48

YATO	(kg)	Ø (mm)	mm	
YT-0864	22.5	18	102x155x17	6/30
YT-0865	34.0	46	122x190x25	6/18

- GB Magnetic welding holder
- D Magnet-Werkstückhalter
- PL Kątownik magnetyczny spawalniczy
- RUS Магнитная струбцина заварки

- CZ Magnetický uhelník ke svařování
- H Mágneses, hegesztő szögvas
- RO Dispozitiv magnetic fixare pt. sudura
- F Support magnétique de soudure

- I Triangolo magnetico da saldatura con interruttore
- E Escuadra magnética de soldadura con interruptor
- CN 焊接磁铁

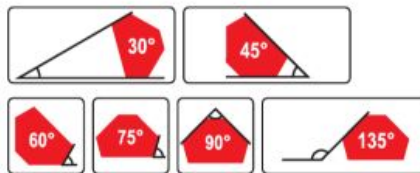

DOUBLE BLISTER



YATO	(kg)	mm	
YT-0866	11.5	64x95x14	6/24
YT-0867	34.0	111x136x24	6/18

- GB Magnetic welding holder with switch
- D Magnet-Werkstückhalter mit Schalter
- PL Kątownik magnetyczny spawalniczy z wyłącznikiem
- RUS Магнитный держатель заварки с выключателем

- CZ Magnetický uhelník ke svařování s vypínačem
- H Mágneses, hegesztő szögvas, kapcsolóval
- RO Dispozitiv magnetic fixare pt. sudura cu intreruptor
- F Support magnétique de soudure

- I Triangolo magnetico da saldatura con interruttore
- E Escuadra magnética de soldadura, con interruptor
- CN 焊接磁铁

DOUBLE BLISTER

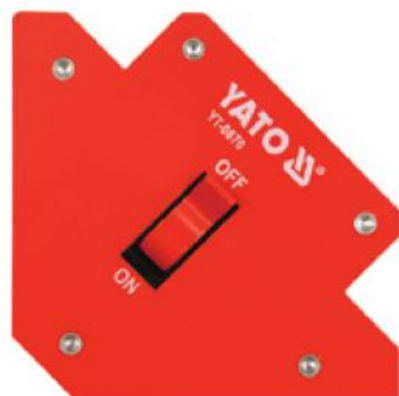









YATO	(kg)	mm	
YT-0870	13.5	107x160x26	6/24

Memo



10

Cutting tools Narzędzia tnące



Drills Wiertła		149-156	Hand taps & sets Gwintowniki i zestawy	160
Twist drill bits HSS & sets Wiertła do metalu HSS i zestawy		149	Circular dies Narzynki	161
Twist drill bits HSS-E Co & sets Wiertła do metalu HSS-E Co i zestawy		149	Step drills Wiertła stopniowe	161
Twist drill bits HSS-TiN & sets Wiertła do metalu HSS-TiN i zestawy		150	Taper drill sets Zestawy wiertel stożkowych	161
Universal drills & sets Wiertła uniwersalne i zestawy		151	Countersinks Pogłębiaki	161
SDS masonry drill bits X-TIP Wiertła do betonu SDS, z grotem krzyżowym		152	Tap wrenches & die holders Pokręta do gwintowników i narzynek	162
SDS masonry drill bits Wiertła do betonu SDS		152	Thread repair sets & accessories Zestawy do naprawy gwintów i akcesoria	162
Masonry drill bits with cylindrical shank & sets Wiertła do betonu z uchwytem cylindrycznym i zestawy		153	Router bits, rotary rasps & sets Frezy do drewna, metalu i zestawy	163-164
Flat wood drill bits & sets Wiertła łopatkowe do drewna i zestawy		154	Diamond tools Narzędzia diamentowe	165-166
Spur wood drill bits Wiertła do drewna spiralne		155	Diamond blades for cutting construction materials Tarcze diamentowe do cięcia materiałów budowlanych	165
Auger wood drill bits & sets Świdry do drewna i zestawy		155	Diamond grinding cup wheels Diamentowe talerze szlifierskie do betonu i kamienia	166
Drills for glass, ceramic tiles & sets Wiertła do szkła, ceramiki, gresu i zestawy		156	Diamond core drill bits Diamentowe wiertła koronowe	166
Adjustable hand reamers Rozwiertaki nastawne		156	Tungsten carbide tipped tools Narzędzia z ostrzem z węgliku wolframu	166-167
Spot weld cutter sets Zestawy rozwiertaków do zgrzewów		156-157	Tungsten carbide saws for wood Tarcze z węglikiem do drewna	166
Tools for dowel joints Narzędzia do połączeń kołkowych		157	Tungsten carbide saws for steel & aluminium Tarcze z węglikiem do stali i aluminium	167
Combination edge setters & hole punch pliers Dziurkarko-felcarki		157	PVC cutting discs Tarcze do cięcia PCV	167
SDS Chisels Przecinaki i dłuta SDS		158	Cutting & grinding discs Tarcze do cięcia i szlifowania	168-169
Hollow drill sets Wiertła koronowe do betonu		158	Stainless steel cutting discs Tarcze do cięcia stali nierdzewnej	168
Bi-metal hole saws Otwornice bimetale		159	Metal cutting discs Tarcze do cięcia metalu	168
Bi-metal hole saws Otwornice bimetale		159	Metal grinding discs Tarcze do szlifowania metalu	168
Arbors for hole saws Uchwyty do otwornic bimetalowych		159	Stone cutting discs Tarcze do cięcia kamienia	168
Hole saw kits Zestawy otwornic bimetalowych		159	Stone grinding discs Tarcze do szlifowania kamienia	168
Taps & dies Narzędzia do gwintowania		160-162	Plate discs with hook fastener Tarcze z rzepem	168
			Cutting & grinding rasp discs Tarcze tarnikowe do cięcia i szlifowania	169
			Shears Nożyce	170-175
			Heavy duty cable cutters Nożyce do cięcia przewodów	170



Tin snips		Knives & blades	
Nożyce do blachy.....	170	Noże i ostrza.....	184
Steel strap cutters		Scissors	
Nożyce do cięcia taśm stalowych.....	174	Nożyczki.....	188
Bolt cutters		Marking out tools	
Nożyce do prętów.....	174	Narzędzia traserskie.....	188
Hydraulic cutters & accessories		Profile gauges	
Nożyce z silownikiem hydraulicznym i akcesoria.....	174	Wzorniki profili.....	189
Cable cutters		Punch sets	
Nożyce do kabli.....	175	Przebijaki do skóry.....	189
Multifunctional scissors		Cutters	
Nożyce wielofunkcyjne.....	175	Obcinaki.....	190
<hr/>		Window scrapers	
Saws & blades		Skrobaki do szyb.....	192
Piły i brzeszczoty		Steel files & sets	
		Pilniki do metalu i zestawy.....	192
	175-181	Needle file sets	
Hand saws		Zestawy pilników iglaków.....	193
Piły do drewna.....	175	Diamond needle files & sets	
Bow saws		Pilniki iglaki diamentowe i zestawy.....	194
Piły kabłąkowe.....	176	Diamond whetstones	
Blades		Osełki diamentowe.....	196
Brzeszczoty.....	177	Rasps & sets	
Hacksaw frames		Tarniki do drewna i zestawy.....	196
Piły do metalu.....	177	Rasps for plaster	
Blades		Tarniki do gipsu.....	196
Brzeszczoty.....	177	<hr/>	
Jig saw blades		Abrasive products	
Brzeszczoty do wyrzynarek.....	177	Artykuły ścierne	
Accessories for multi-purpose oscillating tools			
Akcesoria do wielofunkcyjnych narzędzi oscylacyjnych.....	179		197-201
<hr/>		Sand papers	
Brushes, knives & files		Papiery ścierne.....	197
Szczotki, noże i pilniki		Waterproof sand papers	
		Papiery ścierne wodoodporne.....	198
	182-196	Abrasive clothes	
Wire brushes & sets		Płótna ścierne.....	198
Szczotki druciane i zestawy.....	182	No end abrasive bands	
Cleaning pads for pipes		Taśmy ścierne bezkońcowe.....	198
Włókniny do czyszczenia rur.....	183	Flap discs	
Cup brushes		Ściernice listkowe.....	199
Szczotki tarczowe.....	183	Abrasive sheets and discs	
		Arkusze i krążki ścierne.....	200

GB Twist drill HSS
D Metallschraubbohrer HSS
PL Wiertło do metalu HSS
RUS Сверло по металлу HSS
CZ Vrták na kov HSS
H Fúrószár fémhez HSS
RO Burghiu pt. metal HSS
F Foret métal HSS
I Punta per metallo HSS
E Broca para metal HSS
CN 轧制麻花钻

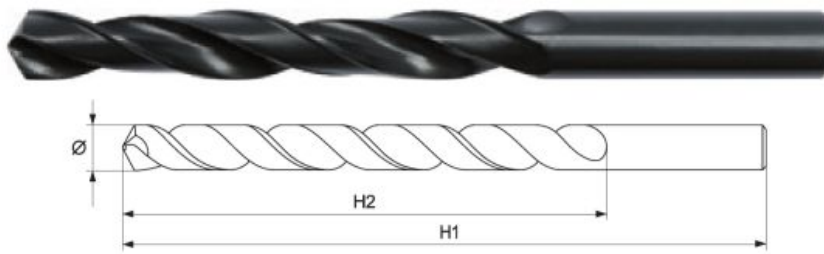

• application: industry
• for precise drilling in steels, cast steels, non-ferrous metals, plastics

• przeznaczenie: przemysł
• do precyzyjnych wierceń w stalach, żeliwach, metalach nieżelaznych, tworzywach sztucznych

YATO	Ø (mm)	H1 (mm)	H2 (mm)	R.P.M.max.	PCS packing	Box
YT-4430	1.0	34	12	3800	10	80/320
YT-4431	1.5	43	20	3800	10	80/320
YT-4432	2.0	49	24	4000	10	80/320
YT-4433	2.5	57	30	3200	10	80/320
YT-4434	2.8	61	33	2800	10	80/320
YT-4435	3.0	61	33	2600	10	80/320
YT-4436	3.2	65	36	2500	10	80/320
YT-4437	3.5	70	39	2300	10	80/320
YT-4438	4.0	75	43	2000	10	80/320
YT-4439	4.2	75	43	1900	10	20/80

YATO	Ø (mm)	H1 (mm)	H2 (mm)	R.P.M.max.	PCS packing	Box
YT-4440	4.5	80	47	1800	10	20/80
YT-4441	4.8	86	52	1600	10	20/80
YT-4442	5.0	86	52	1600	10	20/80
YT-4443	5.2	86	52	1500	10	20/80
YT-4444	5.5	93	57	1500	10	20/80
YT-4445	6.0	93	57	1300	10	20/80
YT-4446	6.5	101	63	1200	10	10/40
YT-4447	7.0	109	69	1100	10	10/40
YT-4448	7.5	109	69	1100	10	10/40
YT-4449	8.0	117	75	1000	10	10/40

YATO	Ø (mm)	H1 (mm)	H2 (mm)	R.P.M.max.	PCS packing	Box
YT-4450	8.5	117	75	900	5	10/40
YT-4451	9.0	125	81	900	5	10/40
YT-4452	9.5	125	81	800	5	10/40
YT-4453	10.0	133	87	800	5	10/40
YT-4454	10.5	133	87	800	3	10/40
YT-4455	11.0	142	94	700	3	10/40
YT-4456	12.0	151	101	700	3	10/40
YT-4457	12.5	151	101	600	3	10/40
YT-4458	13.0	151	101	600	3	10/40

GB Twist drill set
D Metallschraubbohrersatz
PL Komplet wiertel do metalu
RUS Набор сверл по металлу
CZ Souprava vrtáků na kov
H Fúrószárkészlet fémhez
RO Set de burghie pt. metal
F Set des forets métal HSS
I Set punte per metallo
E Broca para metal
CN 轧制麻花钻组套



PLASTIC HANGING BOX



10 PCS
Ø mm 1-10



PLASTIC HANGING BOX



19 PCS
Ø mm 1-10



PLASTIC HANGING BOX

YATO	Ø (mm)	Box
YT-4460	2; 3; 4; 5; 6; 8	15/60

YATO	Ø (mm)	Box
YT-4461	1; 2; 3; 4; 5; 6; 7; 8; 9; 10	20/40

YATO	Ø (mm)	Box
YT-4462	1.0; 1.5; 2.0; 2.5; 3.0; 3.5; 4.0; 4.5; 5.0; 5.5; 6.0; 6.5; 7.0; 7.5; 8.0; 8.5; 9.0; 9.5; 10.0	15/30

GB Twist drill HSS-COBALT
D Metallschraubbohrer HSS-COBALT
PL Wiertło do metalu HSS-COBALT
RUS Сверло по металлу HSS-COBALT
CZ Vrták na kov HSS-COBALT
H Fúrószár fémhez HSS-COBALT
RO Burghiu pt. metal HSS-COBALT
F Foret métal HSS-COBALT
I Punta per metallo HSS-COBALT
E Broca para metal HSS-COBALT
CN 全磨制含钴麻花钻

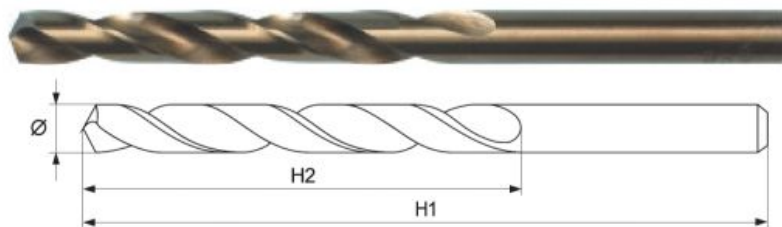

• application: industry
• for precise drilling in hard steels, non-ferrous metals, plastics, stainless steel and acid resistant steel
• resistant to high temperatures

• przeznaczenie: przemysł
• do precyzyjnych wierceń w trudnych materiałach, np. stalach szlachetnych, metalach kolorowych, tworzywach, stalach nierdzewnych i kwasoodpornych
• odporne na działanie wysokiej temperatury

YATO	Ø (mm)	H1 (mm)	H2 (mm)	PCS packing	Box
YT-4020	2.0	49	24	2	125/500
YT-4025	2.5	57	30	2	125/500
YT-4030	3.0	61	33	2	125/500
YT-4032	3.2	65	36	1	100/400
YT-4035	3.5	70	39	1	100/400
YT-4040	4.0	75	43	1	100/400
YT-4042	4.2	75	43	1	100/400
YT-4045	4.5	80	47	1	100/400

YATO	Ø (mm)	H1 (mm)	H2 (mm)	PCS packing	Box
YT-4048	4.8	86	52	1	100/400
YT-4050	5.0	86	52	1	100/400
YT-4052	5.2	86	52	1	100/400
YT-4055	5.5	93	57	1	100/400
YT-4060	6.0	93	57	1	100/400
YT-4065	6.5	101	63	1	75/300
YT-4070	7.0	109	69	1	75/300
YT-4075	7.5	109	69	1	75/300

YATO	Ø (mm)	H1 (mm)	H2 (mm)	PCS packing	Box
YT-4080	8.0	117	75	1	75/300
YT-4085	8.5	117	75	1	75/300
YT-4090	9.0	125	81	1	75/300
YT-4100	10.0	133	87	1	75/300
YT-4110	11.0	142	94	1	75/300
YT-4120	12.0	151	101	1	75/300
YT-4140	14.0	160	108	1	25/100
YT-4160	16.0	178	120	1	25/100

GB Twist drill set
 D Metallschraubbohrersatz
 PL Komplet wiertel do metalu
 RUS Набор сверл по металлу
 CZ Souprava vrtáků na kov
 H Fűrészrészlet fémhez
 RO Set de burghie pt. metal
 F Set des forets métal HSS
 I Set punte per metallo
 E Broca para metal
 CN 轧制麻花钻组套

DIN 338 **HSS-E Co HS6-5-2-5 (PN-EN ISO 4957:2002(U))** **Rm >900 N/mm²** **SPLIT POINT** **135°**

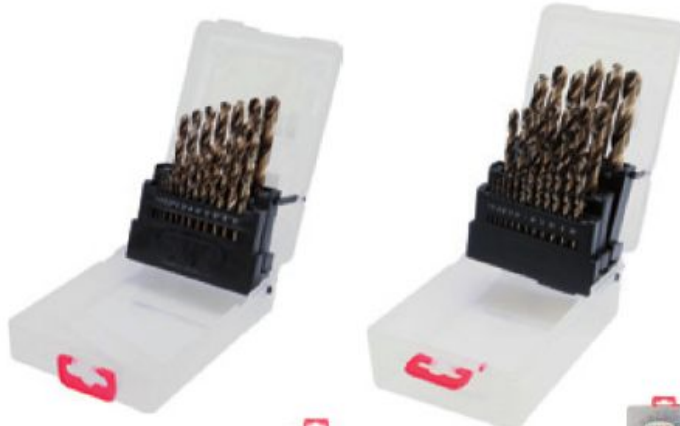

6 PCS **2-8** **PLASTIC HANGING BOX**

YATO	Ø (mm)	15/60
YT-41602	2; 3; 4; 5; 6; 8	

10 PCS **1-10** **PLASTIC HANGING BOX**

YATO	Ø (mm)	20/40
YT-41603	1; 2; 3; 4; 5; 6; 7; 8; 9; 10	

19 PCS **1-10** **PLASTIC HANGING BOX**

YATO	Ø (mm)	15/30
YT-41604	1.0; 1.5; 2.0; 2.5; 3.0; 3.5; 4.0; 4.5; 5.0; 5.5; 6.0; 6.5; 7.0; 7.5; 8.0; 8.5; 9.0; 9.5; 10.0	

25 PCS **1-13** **PLASTIC HANGING BOX**

YATO	Ø (mm)	10
YT-41605	1.0; 1.5; 2.0; 2.5; 3.0; 3.5; 4.0; 4.5; 5.0; 5.5; 6.0; 6.5; 7.0; 7.5; 8.0; 8.5; 9.0; 9.5; 10.0; 10.5; 11.0; 11.5; 12.0; 12.5; 13.0	

GB Twist drill
 D Metallschraubbohrer
 PL Wiertło do metalu
 RUS Сверло по металлу
 CZ Vrták na kov
 H Fűrészrészlet fémhez
 RO Burghiu pt. metal
 F Foret métal
 I Punte per metallo
 E Broca para metal
 CN 全磨制含钴麻花钻

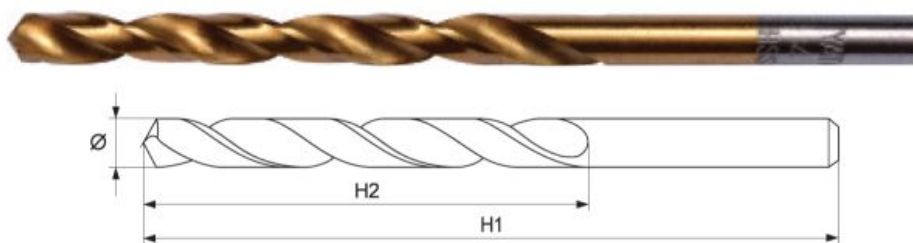

TITANIUM COATED **POWŁOKA Z TYTANU** **DIN 338** **SPLIT POINT** **HSS** **BLISTER CARD**

YATO	Ø (mm)	H1 (mm)	H2 (mm)	PCS packing	15/60
YT-44630	1.0	34	12	2	50/500
YT-44631	1.5	40	18	2	50/500
YT-44632	2.0	49	24	2	50/500
YT-44633	2.5	57	30	2	50/500
YT-44634	2.8	61	33	2	50/500
YT-44635	3.0	61	33	2	50/500
YT-44637	3.2	65	36	1	50/500
YT-44639	3.5	70	39	1	50/500
YT-44640	4.0	75	43	1	50/500
YT-44642	4.2	75	43	1	50/500

YATO	Ø (mm)	H1 (mm)	H2 (mm)	PCS packing	50/500
YT-44643	4.5	80	47	1	50/500
YT-44645	4.8	86	52	1	50/500
YT-44650	5.0	86	52	1	50/500
YT-44652	5.2	86	52	1	50/500
YT-44653	5.5	93	57	1	50/500
YT-44654	6.0	93	57	1	50/500
YT-44655	6.5	101	63	1	50/250
YT-44656	7.0	109	69	1	50/250
YT-44657	7.5	109	69	1	50/250
YT-44658	8.0	117	75	1	50/250

YATO	Ø (mm)	H1 (mm)	H2 (mm)	PCS packing	50/250
YT-44659	8.5	117	75	1	50/250
YT-44660	9.0	125	81	1	50/250
YT-44661	9.5	125	81	1	50/250
YT-44662	10.0	133	87	1	50/200
YT-44663	10.5	133	87	1	50/200
YT-44664	11.0	142	94	1	50/200
YT-44666	12.0	151	101	1	50/100
YT-44667	12.5	151	101	1	50/100
YT-44668	13.0	151	101	1	50/100

GB Twist drill
 D Metallschraubbohrer
 PL Wiertło do metalu
 RUS Сверло по металлу
 CZ Vrták na kov
 H Fűrészrészlet fémhez
 RO Burghiu pt. metal
 F Foret métal
 I Punte per metallo
 E Broca para metal
 CN 全磨制含钴麻花钻



TITANIUM COATED **POWŁOKA Z TYTANU** **DIN 338** **SPLIT POINT** **HSS 4241** **1/4" 6.3 mm** **BLISTER CARD**

YATO	Ø (mm)	H1 (mm)	H2 (mm)	PCS packing	150/600
YT-44750	1.5	63	18	1	150/600
YT-44751	2.0	72	24	1	150/600
YT-44752	2.5	80	30	1	150/600
YT-44754	3.0	81	33	1	150/600
YT-44755	3.2	85	36	1	150/600
YT-44756	3.5	90	39	1	150/600
YT-44757	4.0	95	43	1	150/600
YT-44758	4.2	95	43	1	150/600

YATO	Ø (mm)	H1 (mm)	H2 (mm)	PCS packing	100/400
YT-44759	4.5	100	47	1	150/600
YT-44760	4.8	106	52	1	100/400
YT-44761	5.0	106	52	1	100/400
YT-44763	5.5	113	57	1	100/400
YT-44764	6.0	113	57	1	100/400
YT-44765	6.5	121	63	1	100/400
YT-44766	7.0	109	69	1	100/400
YT-44767	7.5	109	69	1	100/400

YATO	Ø (mm)	H1 (mm)	H2 (mm)	PCS packing	100/400
YT-44768	8.0	117	75	1	100/400
YT-44769	8.5	117	75	1	100/400
YT-44770	9.0	125	81	1	50/200
YT-44772	10.0	133	87	1	50/200
YT-44773	11.0	142	94	1	50/200
YT-44774	12.0	151	101	1	50/200
YT-44776	13.0	151	101	1	50/200

GB Twist drill set
D Metallspiralbohrersatz
PL Komplet wiertel do metalu
RUS Набор сверл по металлу
CZ Souprava vrtáků na kov
H Fúrószárkészet fémhez

RO Set de burghie pt. metal
F Set des forets métal HSS
I Set punte per metallo
E Broca para metal
CN 轧制麻花钻组套



PLASTIC TUBE

YATO	Ø (mm)	
YT-44700	4; 5; 6; 8; 10	30/60

GB Twist drill set
D Metallspiralbohrersatz
PL Komplet wiertel do metalu
RUS Набор сверл по металлу
CZ Souprava vrtáků na kov
H Fúrószárkészet fémhez
RO Set de burghie pt. metal

F Set des forets métal HSS
I Set punte per metallo
E Broca para metal
CN 轧制麻花钻组套

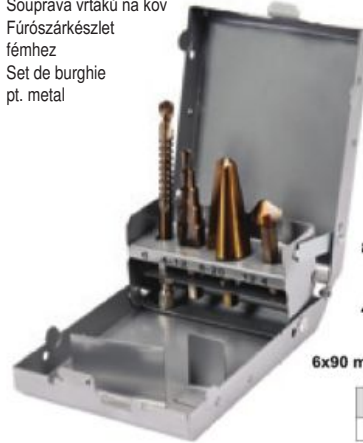
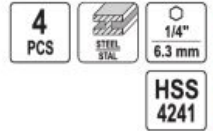

METAL BOX & SLIDING CARD

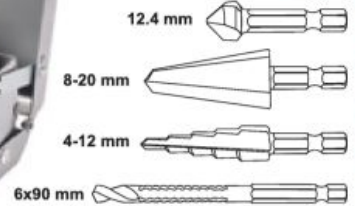

YATO	Ø (mm)	
YT-44705	12/24	

GB Twist drill set
D Metallspiralbohrersatz
PL Komplet wiertel do metalu
RUS Набор сверл по металлу

CZ Souprava vrtáků na kov
H Fúrószárkészet fémhez
RO Set de burghie pt. metal
F Set des forets métal HSS

I Set punte per metallo
E Broca para metal
CN 轧制麻花钻组套



YATO	Ø (mm)	
YT-44673	2; 3; 4; 5; 6; 8	50/100

YATO	Ø (mm)	
YT-44674	1; 2; 3; 4; 5; 6; 7; 8; 9; 10	25/100

YATO	Ø (mm)	
YT-44675	1.0; 1.5; 2.0; 2.5; 3.0; 3.5; 4.0; 4.5; 5.0; 5.5; 6.0; 6.5; 7.0; 7.5; 8.0; 8.5; 9.0; 9.5; 10.0	6/30

YATO	Ø (mm)	
YT-44676	1.0; 1.5; 2.0; 2.5; 3.0; 3.5; 4.0; 4.5; 5.0; 5.5; 6.0; 6.5; 7.0; 7.5; 8.0; 8.5; 9.0; 9.5; 10.0; 10.5; 11.0; 11.5; 12.0; 12.5; 13.0	5/20

GB Universal drill
D Universalbohrer
PL Wiertło uniwersalne
RUS Универсальное сверло с шестигранным
CZ Víceúčelový vrták
H Kőzet és többcéli fúró

RO Burghiu universal cu coada hexagonala
F Forets polyvalents
I Punta universale
E Broca multimatierial
CN 全磨制含钴麻花钻



GB Universal drills
D Universalbohrer -Set
PL Zestaw wiertel uniwersalnych
RUS Набор универсальных сверл с шестигранным хвостовиком
CZ Sada víceúčelový vrtáky
H Keményfém többcéli fúró készlet
RO Set burghie cu coada hexagonala
F Coffrets de forets
I Set di punte universali
E Sets de brocas multimatierial
CN 六角柄多功能钻组套

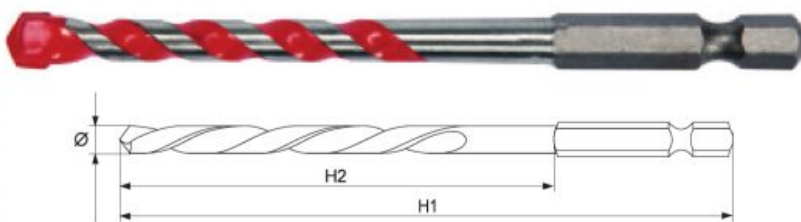
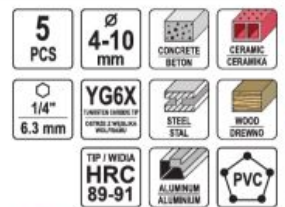

YATO	Ø (mm)	H1 (mm)	H2 (mm)	PCS packing:	
YT-44780	3	85	30	1	250
YT-44781	4	85	30	1	250
YT-44782	5	85	30	1	250
YT-44783	6	85	30	1	250
YT-44784	7	85	30	1	250
YT-44785	8	120	45	1	200
YT-44786	10	120	70	1	200
YT-44787	12	120	70	1	200



PLASTIC HANGING BOX

YATO	Ø (mm)	
YT-44789	4; 5; 6; 8; 10	100

GB Masonry drill bit X-TIP
 D Betonspiralbohrer X-TIP
 PL Wiertło do betonu X-TIP
 RUS Сверло по бетону X-TIP

CZ Vrták na beton X-TIP
 H Fúrószár betonhoz X-TIP
 RO Burghiu pt. beton X-TIP
 F Foret béton à pointe en croix

I Punta per cemento X-TIP
 E Broca para hormigón X-TIP
 CN 十字头电锤钻

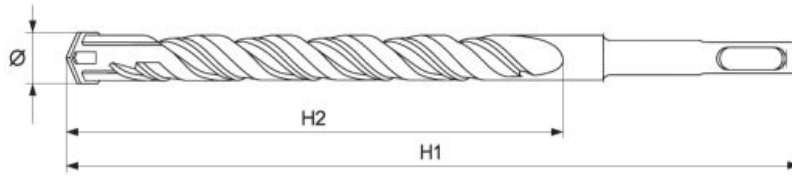

PLASTIC HANGER



YATO	Ø (mm)	H1 (mm)	H2 (mm)	PCS packing	
YT-4200	5	110	45	10	300
YT-4201	6	110	45	10	300
YT-4202	6	160	95	10	200
YT-4203	6	210	135	10	150
YT-4204	8	110	45	10	300
YT-4205	8	160	95	10	200
YT-4206	8	210	140	10	150
YT-4207	8	460	370	10	50
YT-4208	8	600	500	10	50
YT-4209	10	160	95	10	150
YT-4210	10	210	140	10	150

YATO	Ø (mm)	H1 (mm)	H2 (mm)	PCS packing	
YT-4211	10	300	220	10	100
YT-4212	10	460	370	10	50
YT-4213	10	600	500	10	50
YT-4214	12	160	95	10	150
YT-4215	12	260	185	10	100
YT-4216	12	460	360	10	50
YT-4217	12	600	490	10	40
YT-4218	14	260	180	10	80
YT-4219	14	460	360	10	40
YT-4220	16	200	125	10	60
YT-4221	16	460	360	10	20

YATO	Ø (mm)	H1 (mm)	H2 (mm)	PCS packing	
YT-4222	16	600	490	10	20
YT-4223	18	460	360	10	20
YT-4224	18	600	490	10	20
YT-4225	20	460	360	5	20
YT-4226	20	600	490	5	20
YT-4227	22	460	360	5	20
YT-4228	22	600	490	5	20
YT-4229	25	460	360	5	20
YT-4230	25	600	490	5	10

GB Masonry drill bit
 D Betonspiralbohrer
 PL Wiertło do betonu

RUS Сверло по бетону
 CZ Vrták na beton
 H Fúrószár betonhoz

RO Burghiu pt. beton
 F Foret béton
 I Punta per cemento

E Broca para hormigón
 CN 建工钻

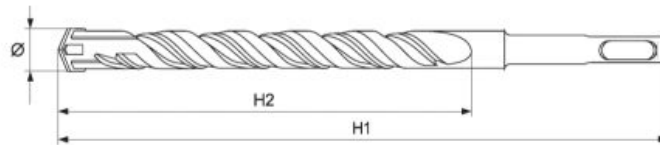

PLASTIC HANGER



YATO	Ø (mm)	H1 (mm)	H2 (mm)	PCS packing	
YT-4161	5	110	45	10	300
YT-4162	6	110	45	10	300
YT-4163	6	160	95	10	200
YT-4164	6	210	140	10	150
YT-4165	8	110	45	10	300
YT-4166	8	160	90	10	200
YT-4167	8	210	140	10	150
YT-4168	8	460	370	10	50
YT-4169	8	600	500	10	50
YT-4170	10	160	95	10	150
YT-4171	10	210	140	10	150

YATO	Ø (mm)	H1 (mm)	H2 (mm)	PCS packing	
YT-4172	10	300	220	10	100
YT-4173	10	460	370	10	50
YT-4174	10	600	500	10	50
YT-4175	12	160	85	10	150
YT-4176	12	260	180	10	100
YT-4177	12	460	360	10	50
YT-4178	12	600	490	10	40
YT-4179	14	260	180	10	80
YT-4180	14	460	360	10	40
YT-4181	16	200	125	10	60
YT-4182	16	300	220	10	50

YATO	Ø (mm)	H1 (mm)	H2 (mm)	PCS packing	
YT-4183	16	460	360	10	20
YT-4184	16	600	490	10	20
YT-4185	18	460	360	10	20
YT-4186	18	600	490	10	20
YT-4187	20	460	360	5	20
YT-4188	20	600	490	5	20
YT-4189	22	460	360	5	20
YT-4190	22	600	490	5	20
YT-4191	25	460	360	5	20
YT-4192	25	600	490	5	10

GB Masonry drill bit
 D Betonspiralbohrer
 PL Wiertło do betonu

RUS Сверло по бетону
 CZ Vrták na beton
 H Fúrószár betonhoz

RO Burghiu pt. beton
 F Foret béton
 I Punta per cemento

E Broca para hormigón
 CN 建工钻

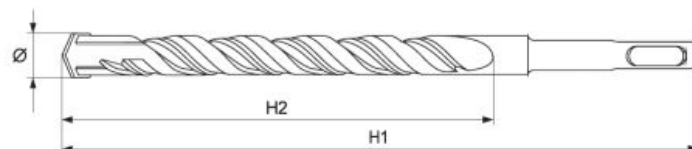

PLASTIC TUBE & PLASTIC HANGER



- for windows assembly
- without necessity of using screw anchors
- do montażu okien
- bez użycia kółków rozporowych

YATO	Ø (mm)	H1 (mm)	H2 (mm)	PCS packing	
YT-41641	6.5	200	130	10	10/150
YT-41642	6.5	260	183	10	10/150

GB Masonry drill bit
D Betonspiralbohrer
PL Wiertło do betonu

RUS Сверло по бетону
CZ Vrták na beton
H Fúrószár betonhoz

RO Burghiu pt. beton
F Foret béton
I Punta per cemento

E Broca para hormigón
CN 建工钻



ADDITIONAL CUTTING EDGES

DODATKOWE KRAWĘDZIE TNĄCE



- resistant for stack in SDS chuck
- DD carbide tip
- automatic soldering
- odporne na zakleszczenie w uchwycie SDS
- widia DD carbide
- automatyczne lutowanie

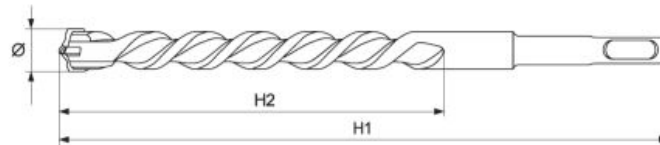

PLASTIC HANGER



YATO	Ø (mm)	H1 (mm)	H2 (mm)	
YT-41930	5	110	50	40/160
YT-41935	5	160	100	40/160
YT-41931	6	110	50	40/160
YT-41936	6	160	100	40/160
YT-41942	6	210	150	40/160
YT-41951	6	460	375	30/120
YT-41960	6	600	525	25/100
YT-41932	7	110	50	40/160
YT-41937	7	160	100	40/160
YT-41933	8	110	50	40/160
YT-41938	8	160	100	40/160
YT-41943	8	210	150	40/160
YT-41952	8	460	375	30/120
YT-41961	8	600	525	20/80
YT-41939	9	160	100	40/160
YT-41944	9	210	150	40/160

YATO	Ø (mm)	H1 (mm)	H2 (mm)	
YT-41934	10	110	50	40/160
YT-41940	10	160	100	40/160
YT-41945	10	210	150	30/120
YT-41953	10	460	375	30/120
YT-41962	10	600	525	20/80
YT-41941	12	160	100	40/160
YT-41946	12	210	150	30/120
YT-41954	12	460	375	20/80
YT-41963	12	600	525	15/60
YT-41969	12	1000	930	50
YT-41947	14	210	150	20/80
YT-41955	14	460	375	20/80
YT-41964	14	600	525	15/60
YT-41970	14	1000	930	40
YT-41948	16	210	150	20/80
YT-41956	16	460	375	15/45

YATO	Ø (mm)	H1 (mm)	H2 (mm)	
YT-41965	16	600	525	10/40
YT-41971	16	1000	930	30
YT-41949	18	210	150	20/80
YT-41957	18	460	375	10/40
YT-41966	18	600	525	5/15
YT-41972	18	1000	930	20
YT-41950	22	210	150	20/80
YT-41958	22	460	375	8/32
YT-41967	22	600	525	5/20
YT-41973	22	1000	930	15
YT-41959	25	460	375	8/32
YT-41968	25	600	525	5/20
YT-41974	25	1000	930	15

GB Masonry drill bit
D Betonspiralbohrer
PL Wiertło do betonu

RUS Сверло по бетону
CZ Vrták na beton
H Fúrószár betonhoz

RO Burghiu pt. beton
F Foret béton
I Punta per cemento

E Broca para hormigón
CN 建工钻



10

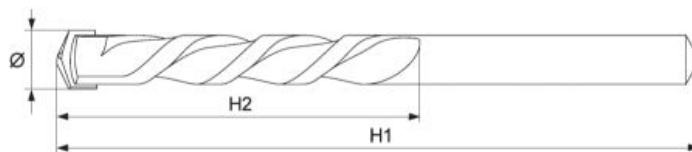

BLISTER CARD



YATO	Ø (mm)	H1 (mm)	H2 (mm)	
YT-4361	4	70	35	100/400
YT-4362	5	90	50	100/400
YT-4363	6	100	60	100/400
YT-4364	6	150	100	100/400
YT-4367	7	100	60	75/300

YATO	Ø (mm)	H1 (mm)	H2 (mm)	
YT-4369	8	120	80	75/300
YT-4370	8	200	140	50/150
YT-4375	10	120	80	75/300
YT-4376	10	200	140	50/150
YT-4379	12	150	100	50/150

YATO	Ø (mm)	H1 (mm)	H2 (mm)	
YT-4380	12	200	140	50/150
YT-4383	14	180	120	25/100
YT-4385	16	180	120	25/100

GB Masonry drill bit set
D Betonspiralbohrersatz
PL Komplet wiertel do betonu

CZ Souprava vrtáků do betonu
H Fúrószárkészlet betonhoz
RO Set de burghie pt. beton
F Set des forets béton

I Set punte per cemento
E Brocas para hormigón
CN 建工钻组套

RUS Сверла по бетону в наборе

7
PCS



PLASTIC HANGING BOX



YATO	Ø (mm)	
YT-4390	4; 5; 6; 8; 9; 10; 12	10/80

GB Flat wood drill bit
D Schaufelbohrer
PL Wiertło łopatkowe do drewna

RUS Перовые сверло
CZ Plochý vrták
H Homlokmarós fúró
RO Burghiu plate

F Mèche à bois plate
I Punta per legno piatta
E Broca de aletas
CN 木工扁钻

DOUBLE BLISTER

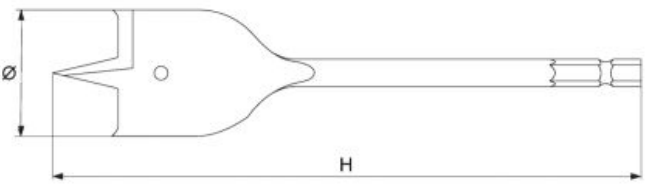

YATO	Ø (mm)	H (mm)	
YT-3236	6	152	50/400
YT-3237	8	152	50/400
YT-3238	10	152	30/300
YT-3239	12	152	50/300
YT-3240	13	152	50/300
YT-3241	14	152	50/300
YT-3242	16	152	50/300
YT-3243	18	152	50/300
YT-3244	20	152	50/300
YT-3245	22	152	50/300

YATO	Ø (mm)	H (mm)	
YT-3246	24	152	50/300
YT-3247	25	152	50/300
YT-3248	26	152	50/300
YT-3249	28	152	50/300
YT-3250	30	152	50/200
YT-3251	32	152	50/200
YT-3252	34	152	50/200
YT-3253	35	152	50/200
YT-3254	38	152	50/200
YT-3255	40	152	50/200

GB Extension for flat wood drill bits
D Verlängerung für Schaufelbohrer
PL Przedłużka do wiertel łopatkowych, bitów i wiertel

RUS Удлинитель для перовых сверл
CZ Nástavec pro ploché vrtáky
H Hosszabbító homlokmarós fafúrókhoz
RO Prelungitor pt. burghie plate
F Rallonge pour mèches à bois
I Prolunga per punta fresatrice
E Extensión para brocas de aletas
CN 木工扁钻延长杆

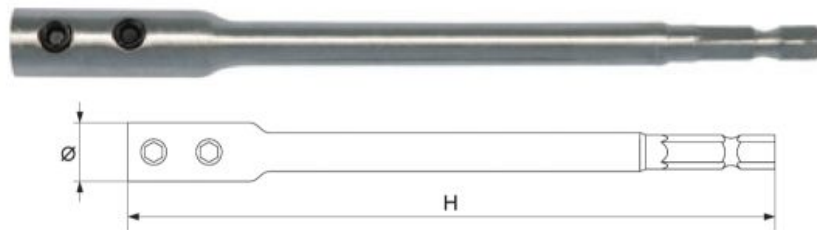

DOUBLE BLISTER

YATO	Ø (mm)	H (mm)	
YT-3256	12.2	150	60/120
YT-3257	13.5	300	30/60

GB Flat wood drill bit set
D Schaufelbohrersatz
PL Zestaw wiertel łopatkowych
RUS Набор перовых сверл
CZ Sada plochých vrtáků
H Homlokmarós fafúró készlet
RO Set burghie plate
F Set de mèche à bois
I Set di punta per legno piatta
E Juego de brocas de aletas
CN 木工扁钻组套

POUCH



6 PCS



PLASTIC CASE & DOUBLE BLISTER



8 PCS



GB Flat wood drill bit set
D Schaufelbohrersatz
PL Zestaw wiertel łopatkowych
RUS Набор перовых сверл
CZ Sada plochých vrtáků
H Homlokmarós fafúró készlet
RO Set burghie plate
F Set de mèche à bois
I Set di punta per legno piatta
E Juego de brocas de aletas
CN 木工扁钻组套



YATO	Ø (mm)	H (mm)	
YT-3258	10; 12; 16; 18; 20; 25	152	25/50



YATO	Ø (mm)	H (mm)	
YT-3259	12; 16; 18; 20; 22; 25; 28; 32	152	5/20

GB Spur wood drill bit
D Spiralbohrer für Holz
PL Wiertło do drewna spiralne

RUS Спиральное сверло по дереву
CZ Vrták do dřeva spirálový
H Csigafúró fához

RO Burghiu spirală pt. lemn
F Mèches hélicoïdales à bois
I Punta per legno spirale

E Barrena para madera espiral
CN 木工钻

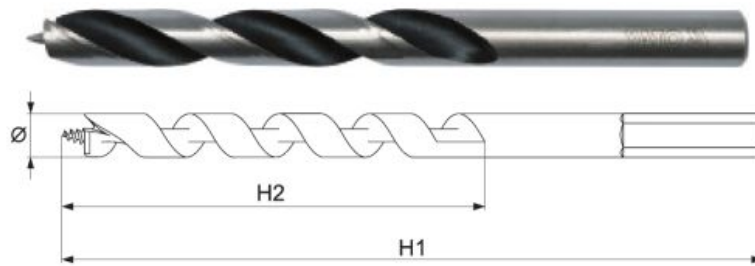

DOUBLE
BLISTER

YATO	Ø (mm)	H1 (mm)	H2 (mm)	
YT-4350	3	60	35	30/300
YT-4351	4	75	44	30/300
YT-4352	5	85	52	30/300
YT-4353	6	90	57	30/300
YT-4354	7	100	67	30/300

YATO	Ø (mm)	H1 (mm)	H2 (mm)	
YT-4355	8	110	75	30/300
YT-4356	10	120	77	30/300
YT-4357	12	150	97	15/120
YT-4358	13	150	102	15/120
YT-4359	16	160	120	15/120

GB Auger wood drill bit
D Holzbohrer
PL Świder do drewna

RUS Бур по дереву
CZ Vrták do dřeva hadovitý
H Fafúró

RO Burghiu elicoidal pt. lemn
F Foret spirale à bois
I Punta a torciglione per legno

E Barrena para madera
CN 螺旋木工钻

13mm

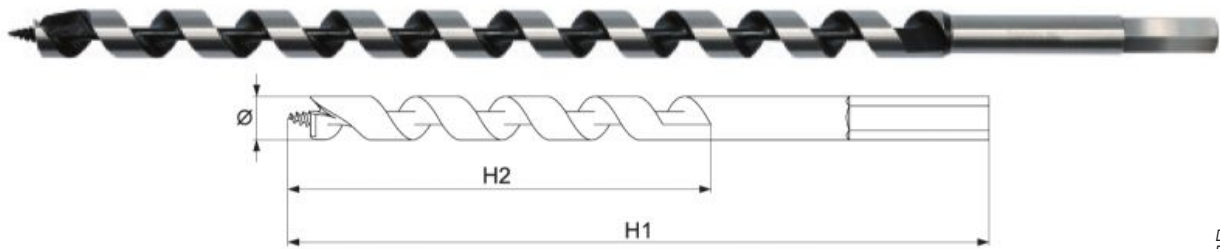

DOUBLE
BLISTER

YATO	Ø (mm)	H1 (mm)	H2 (mm)	
YT-3261	6	191	121	60/360
YT-3262	8	191	121	70/280
YT-3263	8	400	310	60/120
YT-3264	10	191	121	50/200
YT-3265	10	400	310	50/100
YT-3266	12	191	121	50/150
YT-3267	12	400	310	20/60
YT-3268	13	191	121	50/100
YT-3269	13	400	310	20/60
YT-3270	14	191	121	50/100
YT-3271	14	400	310	20/60
YT-3272	16	191	121	50/100
YT-3273	16	400	310	20/40

YATO	Ø (mm)	H1 (mm)	H2 (mm)	
YT-3274	18	215	142	40/80
YT-3275	18	400	310	20/40
YT-3276	20	215	145	20/60
YT-3277	20	400	310	20/40
YT-3278	22	215	145	20/60
YT-3279	22	400	310	10/30
YT-3280	24	215	145	20/60
YT-3281	24	400	310	6/30
YT-3282	25	215	145	20/40
YT-3283	25	400	310	5/25
YT-3284	26	215	145	10/40
YT-3285	26	400	310	10/20
YT-3286	28	240	145	6/24

YATO	Ø (mm)	H1 (mm)	H2 (mm)	
YT-3287	28	400	310	5/20
YT-3288	30	240	170	10/30
YT-3289	30	400	310	5/10
YT-3290	32	240	170	5/25
YT-3291	32	400	310	5/15
YT-3292	35	240	170	5/20
YT-3293	35	400	310	5/10
YT-3294	36	240	170	10/20
YT-3295	36	400	310	5/10
YT-3296	38	240	170	5/15
YT-3297	40	240	170	5/15

GB Auger wood drill bit set
D Holzbohrersatz
PL Zestaw świderów do drewna
RUS Набор буров по дереву
CZ Sada hadovitých vrtáků do dřeva
H Fafúró készlet
RO Set de burghie elicoidale pt. lemn
F Set de forets spirales à bois
I Set di punte a torciglione
E Juego de barrenas para madera
CN 螺旋木工钻组套



WOOD CASE
& COLOR BOX

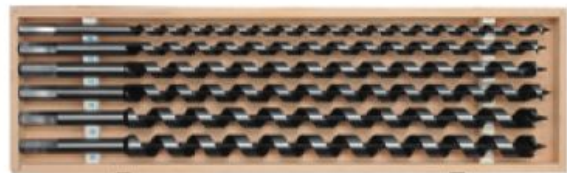

6 PCS	13mm	YATO	Ø (mm)	H (mm)	
		YT-3299	10; 12; 14; 16; 18; 20	460	8



6 PCS	13mm	YATO	Ø (mm)	H (mm)	
		YT-3298	10; 12; 14; 16; 18; 20	230	15

6 PCS	SDS PLUS	YATO	Ø (mm)	H (mm)	
		YT-3300	10; 12; 14; 16; 18; 20	200	20

GB Drill for ceramic tiles
 D Keramik und Fliesen Bohrer
 PL Wiertło do ceramiki i gresu
 RUS Бурильные плитки и керамики
 CZ Vrtací tašek a keramických výrobků

H Fűrő cserép és kerámia
 RO Burghiu pt. ceramica si sticla
 F Tuiles de forage et de la céramique

I Piastrelle e ceramiche trapano
 E Azulejos y cerámicas de perforación
 CN 玻璃钻

SLIDING CARD



YATO	Ø (mm)	
YT-3725	4	100/400
YT-3726	6	100/400

YATO	Ø (mm)	
YT-3727	8	100/400
YT-3728	10	50/200

GB Drill for glass
 D Bohrer für Glas
 PL Wiertło do szkła
 RUS Сверло по стеклу
 CZ Vrták do skla
 H Üvegűró

RO Burghiu pt. sticlă
 F Drill pour le verre
 I Piastrelle e ceramiche trapano
 E Broca para vidrio
 CN 玻璃钻



GB Glass and tile drills
 D Glas- und Fliesenbohrer
 PL Zestaw wiertel do szkła i ceramiki
 RUS Набор сверл по стеклу и керамике
 CZ Vrtáky do skla a keramiky
 H Üveg és kerámi fűrők
 RO Set burghii pt. sticla si ceramica
 F Forets de verre et de tuile
 I Piastrelle e ceramiche trapano
 E Juego de brocas, ceramica
 CN 玻璃钻

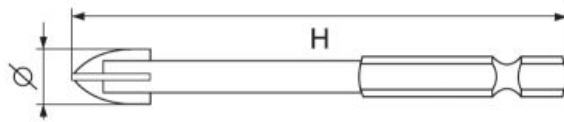
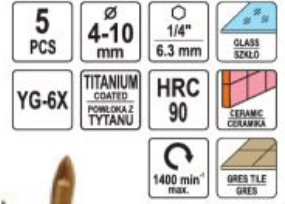

BLISTER CARD

YATO	Ø (mm)	H (mm)	
YT-44800	3	88	500
YT-44801	4	88	500
YT-44802	5	88	500
YT-44803	6	88	500
YT-44804	8	88	500
YT-44805	10	105	500
YT-44806	12	105	400



PLASTIC HANGING BOX

YATO	Ø (mm)	
YT-44809	4; 5; 6; 8; 10	200

GB Adjustable hand reamer
 D Verstellbare Reibahle
 PL Rozwiertak nastawny

RUS Регулируемая развертка
 CZ Nastavitelný výstružník
 H Állítható dörzsár

RO Alezor reglabil
 F Alesoir à main réglable
 I Alesatore regolabile

E Escariador ajustable
 CN 可调式手动铰刀

PLASTIC TUBE



YATO	working diameter / średnica robocza (mm²)	L (mm)	arbor diameter / średnica trzpienia (mm²)	
YT-28950	7.75-8.5	107	4.5	50/200
YT-28951	8.5-9.25	112	4.5	50/200
YT-28952	9.25-10	116	5.0	50/200
YT-28953	10-10.75	125	5.5	50/200
YT-28954	10.75-11.75	130	6.5	50/200
YT-28955	11.75-12.75	135	7.5	50/150
YT-28956	12.75-13.75	140	7.5	50/150
YT-28957	13.75-15.25	158	8.0	20/60
YT-28958	15.25-17	165	9.0	20/60

YATO	working diameter / średnica robocza (mm²)	L (mm)	arbor diameter / średnica trzpienia (mm²)	
YT-28959	17-19	175	10.0	20/60
YT-28960	19-21	180	11.5	20/60
YT-28961	21-23	193	13.5	20/60
YT-28962	23-26	210	15.4	4/20
YT-28963	26-29.5	245	17.0	4/20
YT-28964	29.5-33.5	270	19.0	4/12
YT-28965	33.5-38	310	21.0	2/10
YT-28966	38-44	345	24.0	2/10
YT-28967	44-54	400	30.0	5

GB Spot weld cutter & drill bit set
 D Schweisspunktbohrer Set
 PL Zestaw rozwiertaków do zgrzewów punktowych
 RUS Набор для высверливания точечной сварки
 CZ Sada na odvrtání bodových svárů
 H Hegesztőpont maró készlet
 RO Set de freze pt. suduri in puncte
 F Jeu de fraises pour points de soudage
 I Set di alesatori per punti di saldatura
 E Juego de brocas para puntos de soldadura de la fresa
 CN 点焊刀



METAL BOX & COLOR BOX

YATO	
YT-28920	10/60

GB Drill welding points set
 D Schweisspunkt-Fräsersatz
 PL Zestaw wiertel do zgrzewów punktowych
 RUS Набор сверл для точечной сварки
 CZ Frézy pro bodové sváry
 H Pont hegesztés lefűrő készlet
 RO Set burghiu puncte sudura
 F Forets à dépointer les points soudure
 I Set di alesatori per punti di saldatura
 E Juego de brocas para puntos de soldadura
 CN 3件套电焊



YATO	Ø (mm)	
YT-28921	6.5; 8.0; 10.0	50

- GB** Metal limiters
for drilling-collar
D Metallgrenzen für Bohren
PL Ogranicznik głębokości wiercenia
RUS Ограничитель глубины для сверл
CZ Omezovač hloubky vrtáků
H Mélysegűtközők
RO Limitator de metal pt. burghiu
F Butées de profondeur
I Stopper di profondità
E Limitador de brocas
CN 木工定位器

3
PCS

6, 8, 10
mm

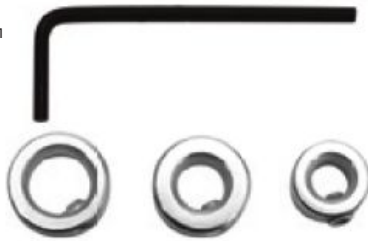

SKIN
CARD

YATO	Ø (mm)	
YT-44100	6; 8; 10	250/500

- GB** Dowelling centre points
D Holzdübel-Markierspitzen
PL Znaczniki do wyznaczania otworów
RUS Набор кернов
для мебельных шкантов
CZ Značící hroty pro kolikování

- H** Tipii jelölő
RO Cep pt. centrare
F Centreurs
I Marcatori per fori
E Centrades
CN 木工顶尖组套

4
PCS



BLISTER
CARD



YATO	Ø (mm)	
YT-44104	6	25/100
YT-44105	8	25/100
YT-44106	10	25/100

- GB** Dowel kit
D Holzdübeln-Werkzeugsatz
PL Zestaw do połączeń kołkowych
RUS Набор для соединения на шкантах
CZ Univerzální kolikovací set
H Univerzális tipliző szett
RO Set cepi
F Kit d'assemblage bois en mains libres
I Set per collegamenti a piolo
E Conjunto de montaje madera
CN 圆销钉组套



BLISTER
CARD



17
PCS



Set includes:

- 10 pcs of wood dowel pins 6 x 30 mm
- 4 pcs of dowelling centre points 6 mm
- 1 pc of drill stop 6 mm
- 1 pc of hex key 2.5 mm
- 1 pc of brad point drill bit 6 x 90 mm

Skład zestawu:

- 10 kółków drewnianych rowkowanych 6 x 30 mm
- 4 znaczniki 6 mm
- 1 ogranicznik głębokości wiercenia 6 mm
- 1 klucz imbus 2.5 mm do blokowania ogranicznika
- 1 wiertło do drewna 6 x 90 mm

6 mm

Set includes:

- 10 pcs of wood dowel pins 8 x 40 mm
- 4 pcs of dowelling centre points 8 mm
- 1 pc of drill stop 8 mm
- 1 pc of hex key 2.5 mm
- 1 pc of brad point drill bit 8 x 100 mm

Skład zestawu:

- 10 kółków drewnianych rowkowanych 8 x 40 mm
- 4 znaczniki 8 mm
- 1 ogranicznik głębokości wiercenia 8 mm
- 1 klucz imbus 2.5 mm do blokowania ogranicznika
- 1 wiertło do drewna 8 x 100 mm

8 mm

Set includes:

- 10 pcs of wood dowel pins 10 x 40 mm
- 4 pcs of dowelling centre points 10 mm
- 1 pc of drill stop 10 mm
- 1 pc of hex key 2.5 mm
- 1 pc of brad point drill bit 10 x 110 mm

Skład zestawu:

- 10 kółków drewnianych rowkowanych 10 x 40 mm
- 4 znaczniki 10 mm
- 1 ogranicznik głębokości wiercenia 10 mm
- 1 klucz imbus 2.5 mm do blokowania ogranicznika
- 1 wiertło do drewna 10 x 110 mm

10 mm

YATO	Ø (mm)	
YT-44112	6	4/100

YATO	Ø (mm)	
YT-44111	8	4/100

YATO	Ø (mm)	
YT-44113	10	4/100

- GB** Drill guider with handle
D Bohrschablone für Holzarbeiten
PL Przyrząd do połączeń kołkowych
RUS Кондуктор шаблон для сверления
CZ Kolikovací přípravek
H Univerzális tiplizőszablon
RO Ghidaj pt. gaurit
F Guides d'assemblage
I Attrezzo per serraggio dei pioli
E Guía de perforación
CN 摆臂斜孔定位器



6, 8, 10
mm

AI

COLOR
BOX



YATO	Ø (mm)	
YT-44120	6; 8; 10	10

- GB** Combination edge setter / hole punch pliers
D Kombinierte Absetzange Lochzange
PL Dziurkarko-felcarka
RUS Дырокол, кромкогиб
CZ Falcovačka a děrovačka
H Lyukasztó peremező fogó
RO Cleste pt. fasonat si gaurit tabla
F Pince spéciale perforatrice carrosserie
I Combinazione: bordo setter / pinza perforare
E Solapadora y ponchadora manual
CN 点焊刀



13 mm
22 mm

5 mm
20 mm

HANGING
COLOR BOX



YATO		
YT-21582		10

GB Point chisel SDS+ RUS Зубило SDS+ RO Punctator SDS+ E Cincel puntiagudo SDS+
 D Spitzmeissel SDS+ CZ Sekáč špičák SDS+ F Perçoir SDS+ CN SDS尖齒
 PL Przecinak SDS+ H Hegyes véső SDS+ I Scalpello SDS+



PLASTIC HANGER



4x14 x250 mm SDS PLUS CrV

YATO	L (mm)	
YT-4720	250	6/48

GB Wood chisel SDS+ RUS Долото столярски SDS+ RO Daltă de tâmplărie SDS+ E Cincel para madera SDS+
 D Stechbeitel SDS+ CZ Rezbářské dláto SDS+ F Ciseau SDS+ CN SDS木工齒
 PL Dłuto do drewna SDS+ H Asztalos véső SDS+ I Scalpello SDS+



PLASTIC HANGER



180 mm SDS PLUS CHISEL PRZECINAK 12 mm WOOD BREWNO CrMo

YATO	L (mm)	
YT-4720L	180	10/80

GB Flat chisel SDS+ RUS Долото узкое SDS+ RO Punctator pt. adancit SDS+ E Cincel plano estrecho SDS+
 D Flachmeissel SDS+ CZ Sekáč plochý SDS+ F Ciseau SDS+ CN SDS平齒
 PL Dłuto wąskie SDS+ H Lapos véső SDS+ I Scalpello punto stretto SDS+



PLASTIC HANGER



20x14 x250 mm SDS PLUS CrV

YATO	L (mm)	
YT-4721	250	6/48

GB Hollow chisel SDS+ RUS Бороzdник SDS+ RO Punctator pt. adancit SDS+ E Cincel acanalado SDS+
 D Nutenmeissel SDS+ CZ Sekáč drážkovací SDS+ F Burin à entailler SDS+ CN SDS空心齒
 PL Bruzdownik SDS+ H Horonyvéső SDS+ I Calibro scalpello SDS+



PLASTIC HANGER



22x18 x250 mm SDS PLUS CrV

YATO	L (mm)	
YT-4722	250	6/48

GB Flat chisel SDS+ RUS Долото плоское SDS+ RO Punctator tip dalta SDS+ E Cincel plano SDS+
 D Spatmeissel SDS+ CZ Sekáč plochý SDS+ F Ciseau SDS+ CN SDS平齒
 PL Dłuto płaskie SDS+ H Széles lapos véső SDS+ I Scalpello piatto SDS+



PLASTIC HANGER



40x14 x250 mm SDS PLUS CrV

YATO	L (mm)	
YT-4723	250	6/48

GB Flat chisel SDS+ RUS Долото плоское SDS+ RO Punctator tip dalta SDS+ E Cincel plano SDS+
 D Spatmeissel SDS+ CZ Sekáč plochý SDS+ F Ciseau SDS+ CN SDS平齒
 PL Dłuto płaskie SDS+ H Széles lapos véső SDS+ I Scalpello piatto SDS+



PLASTIC HANGER



250 mm SDS PLUS CHISEL PRZECINAK 80 mm CrMo

YATO	L (mm)	
YT-47212	250	10/20

GB Point chisel RUS Зубило пиковое RO Dorn E Cin-el para impulsor
 D Spitzmeissel CZ Špičák F Burin pointu de varilla rectificada
 PL Przecinak do uziomów i wbijania prętów oraz gwoździ H Hegyes véső I Scalpello CN 圓孔齒



PLASTIC HANGER



250 mm SDS MAX 20 mm CrMo

YATO	L (mm)	
YT-4718	250	4/24

GB Hollow drill set CZ Korunový vrták na zed' I Punta a corona per calcestruzzo
 D Bohrkronen H Koronafúró falhoz E Broca widia para muro
 PL Wiertło koronowe do betonu RO Burghiu cu coroaană pt. beton CN 扩孔钻
 RUS Сверла по бетону корончатые F Trépied à mur

COLOR BOX



CONCRETE BETON TCT YG-11C Cr50 50 mm M16



HEX 12mm

SDS PLUS

YATO	Ø (mm)	TCT	
YT-4400	65	6	24
YT-4401	80	8	20

YATO	Ø (mm)	TCT	
YT-4402	65	6	24
YT-4403	80	8	20

- GB Bi-metal hole saw
D Bimetall-Lochsäge
PL Otwornica bimetalowa
RUS Ножовка к отверстиям би-металлическая
CZ Vrtací korunka bimetalová
H Bi-metál koronafúró
- RO Găurător bi-metalici
F Scie-trépan bimétal
I Foro sega utensile da taglio bi-metallo
E Sierra de marquetería bi-metálica
CN 双金属孔锯

- application: industry
- to drill holes in stainless steels, cast steels, aluminium, wood, plastics
- cutting depth: 40 mm
- przeznaczenie: przemysł
- do wycinania otworów w stalach nierdzewnych, żelazie, aluminium, drewnie, tworzywach sztucznych
- głębokość cięcia: 40 mm



YATO	Ø (mm)	thread / gwint	
YT-3303	19	1/2" (12.5 mm)	25/100
YT-3304	20	1/2" (12.5 mm)	25/100
YT-3306	22	1/2" (12.5 mm)	25/100
YT-3308	25	1/2" (12.5 mm)	25/100
YT-3311	29	1/2" (12.5 mm)	25/100
YT-3313	32	5/8" (16 mm)	25/100
YT-3315	35	5/8" (16 mm)	25/100
YT-3317	38	5/8" (16 mm)	25/100
YT-3318	40	5/8" (16 mm)	25/100
YT-3321	44	5/8" (16 mm)	25/100

YATO	Ø (mm)	thread / gwint	
YT-3322	46	5/8" (16 mm)	25/100
YT-3323	48	5/8" (16 mm)	25/100
YT-3324	51	5/8" (16 mm)	25/100
YT-3327	57	5/8" (16 mm)	25/50
YT-3329	60	5/8" (16 mm)	25/50
YT-3330	64	5/8" (16 mm)	25/50
YT-3332	67	5/8" (16 mm)	25/50
YT-3333	68	5/8" (16 mm)	25/50
YT-3334	70	5/8" (16 mm)	25/50
YT-3336	76	5/8" (16 mm)	25/50

YATO	Ø (mm)	thread / gwint	
YT-3338	83	5/8" (16 mm)	25/50
YT-3343	95	5/8" (16 mm)	25/50
YT-3345	102	5/8" (16 mm)	10/20
YT-3346	105	5/8" (16 mm)	10/20
YT-3349	114	5/8" (16 mm)	10/20
YT-3350	121	5/8" (16 mm)	10/20
YT-3351	127	5/8" (16 mm)	10/20
YT-3353	140	5/8" (16 mm)	10/20

- GB Arbor for hole saw
D Halterung für Lochsägen
PL Uchwyt do otwornic
RUS Рукоятка к ножовке
CZ Šroubový unášec pro vrtací korunky
- H Befogószár a koronafúróhoz
RO Dispozitiv de antrenare pt. găurători bi-metalici
F Mandrin aux scies-trépan
- I Pergolato per sega
E Mango para las sierras de marquetería
CN 孔锯柄轴



YATO	SDS+ / HEX	
YT-3370	HEX 7/16" (11 mm)	25/100
YT-3373	SDS+	25/100

YATO	SDS+ / HEX	
YT-3371	HEX 7/16" (11 mm)	25/100

YATO	SDS+ / HEX	
YT-3372	HEX 7/16" (11 mm)	25/50
YT-3374	SDS+	25/50

- GB Pilot drill
D Pilotbohrer
PL Wiertło pilot
RUS Сверло пилот
CZ Středící vrták
H Központfúró
- RO Burghiu pilot
F Foret - pilot
I Punta pilota
E Broca piloto
CN 导向钻



YATO	Ø (mm)	H (mm)	
YT-3376	6.0	75	25/100

YATO	Ø (mm)	H (mm)	
YT-3377	6.0	100	25/100

- GB Electrician's hole saw kit
D Lochsägensatz für Elektriker
PL Zestaw otwornic dla elektryków
RUS Набор ножовок к отверстиям для электриков
CZ Sada vrtacích korunek pro elektrikáře
H Koronafúró készlet villanyszerelőknek
- RO Set de găuritori pt. electricieni
F Set de scies trépan aux électriciens
I Set universale a tazza fresa con strumenti
E Juego de sierras de marquetería para electricistas
CN 双金属开孔器组套



YATO	Ø (mm)	
YT-3380	22; 29; 35; 44; 67; 73	10

- GB Combination hole saw kit
D Universal-Lochsägensatz
PL Uniwersalny zestaw otwornic
RUS Универсальный набор ножовок к отверстиям
CZ Univerzální sada vrtacích korunek
H Univerzális koronafúró készlet
- RO Set univesal de găuritori
F Set de scies trépan universelles
I Set universale a tazza fresa con strumenti
E Juego universal de sierras de marquetería
CN 双金属开孔器组套



YATO	Ø (mm)	
YT-3381	19; 22; 25; 32; 35; 38; 44; 51; 57; 64; 76	5

- GB Hand tap
 D Handgewindebohrer
 PL Gwintownik ręczny
 RUS Ручной метчик
 CZ Závitník
 H Menetfúró
- RO Tarozii
 F Taraud à main
 I Maschi filettatura a mano
 E Machos de roscar
 CN 三件套手动丝锥



SLIDING CARD



3 PCS

DIN 352

HSS M2

3-STAGE TAPPING
G2WYTONAME
1-STOPNOME

METRIC COARSE
G2WYTONAME
G2WYTONAME

YATO	size x pitch rozmiar x skok gwintu	thread length (mm) długość gwintu (mm)	L (mm)	shank diameter (mm) średnica trzonu (mm)	PCS packtg	weight (g) waga (g)	
YT-2930	M3x0.5	11	40	3.5	3	25	100/400
YT-2931	M4x0.7	13	45	4.5	3	35	50/200
YT-2932	M5x0.8	16	50	6.0	3	45	60/240
YT-2933	M6x1.0	19	50	6.0	3	45	60/240
YT-2934	M7x1.0	19	50	6.0	3	55	75/300
YT-2935	M8x1.25	22	56	6.0	3	60	50/200
YT-2937	M10x1.5	24	70	7.0	3	85	50/200

YATO	size x pitch rozmiar x skok gwintu	thread length (mm) długość gwintu (mm)	L (mm)	shank diameter (mm) średnica trzonu (mm)	PCS packtg	weight (g) waga (g)	
YT-2939	M12x1.75	29	75	9.0	3	125	50/200
YT-2940	M14x2.0	30	80	10.5	3	200	20/80
YT-2941	M16x2.0	32	80	11.0	3	235	20/80
YT-2942	M18x2.5	40	95	12.0	3	345	20/80
YT-2943	M20x2.5	40	95	14.0	3	445	20/40
YT-2926	M22x2.5	40	100	18.0	3	600	10/40

- GB Machine tap
 D Maschinengewindebohrer
 PL Gwintownik maszynowy
 RUS Машинный метчик
 CZ Strojní závitník
 H Gépi menetfúró
- RO Tarod de maşină
 F Taraud machine
 I Maschi filettatura
 E Macho mecanico
 CN 机用丝锥

DIN 371M

HSS M2

1-STAGE TAPPING
G2WYTONAME
1-STOPNOME

METRIC COARSE
G2WYTONAME
G2WYTONAME

- GB Machine tap
 D Maschinengewindebohrer
 PL Gwintownik maszynowy
 RUS Машинный метчик
 CZ Strojní závitník
 H Gépi menetfúró
- RO Tarod de maşină
 F Taraud machine
 I Maschi filettatura
 E Macho mecanico
 CN 机用丝锥

DIN 376

HSS M2

1-STAGE TAPPING
G2WYTONAME
1-STOPNOME

METRIC COARSE
G2WYTONAME
G2WYTONAME



SLIDING CARD

YATO	size x pitch rozmiar x skok gwintu	thread length (mm) długość gwintu (mm)	L (mm)	shank diameter (mm) średnica trzonu (mm)	weight (g) waga (g)	
YT-2950	M3x0.5	11	56	3.5	15	100/400
YT-2951	M4x0.7	13	63	4.5	20	100/400
YT-2952	M5x0.8	16	70	6.0	25	60/240
YT-2953	M6x1.0	19	80	6.0	30	50/200
YT-2954	M7x1.0	19	80	7.1	35	30/120
YT-2955	M8x1.25	22	90	8.0	45	50/200
YT-2956	M10x1.5	24	100	10.0	65	50/200

YATO	size x pitch rozmiar x skok gwintu	thread length (mm) długość gwintu (mm)	L (mm)	shank diameter (mm) średnica trzonu (mm)	weight (g) waga (g)	
YT-2944	M12x1.75	29	110	9.0	70	25/100
YT-2945	M14x2.0	30	110	11.0	110	25/100
YT-2946	M16x2.0	32	110	12.0	120	25/100
YT-2947	M18x2.5	34	125	14.0	200	25/100
YT-2948	M20x2.5	34	140	16.0	260	25/100
YT-2949	M22x2.5	34	140	18.0	340	20/80
YT-2957	M24x3.0	38	160	18.0	400	15/60
YT-2958	M27x3.0	38	160	20.0	500	15/60
YT-2959	M30x3.5	45	180	22.0	700	15/60

10

- GB Taps and dies set
 D Gewindeschneidwerkzeug-Satz
 PL Zestaw narzynek i gwintowników
 RUS Набор плашек и метчиков
 CZ Souprava závitníků
 a kruhových závitových čelostí
 H Menetfúró és menetvágó készlet
 RO Set de tarozii și filiere
 F Set de filières et tarauds
 I Set di filiera a maschi
 E Juego de machosde
 roscar y cojinetes
 CN 丝锥板牙组套



METAL CASE
& COLOR BOX

HSS



44 PCS

DIN223
DIN225
DIN338
DIN352
DIN1814



YATO

size / rozmiar

YT-2978

M3; M4; M5; M6; M8; M10; M12

4

32 PCS

DIN223
DIN352



YATO

size / rozmiar

YT-2975

M3; M4; M5; M6; M8; M10; M12

10

56 PCS

DIN223
DIN225
DIN352
DIN1814



YATO

size / rozmiar

YT-2979

M3; M4; M5; M6; M8; M10; M12; M14; M16; M18; M20

2

- GB Taps set
D Gewindeschneidwerkzeug-Satz
PL Zestaw gwintowników
RUS Набор метчиков
CZ Souprava závitníků
H Menetfűrő készlet
RO Set de tarozi
F Set de tarauds
I Set di filettature
E Juego de machos de roscar
CN 丝锥组套



21
PCS

DIN
352

29
PCS

DIN338
DIN352
DIN1814



YATO	size / rozmiar	
YT-2976	M3; M4; M5; M6; M8; M10; M12	20

YATO	size / rozmiar	
YT-2977	M3; M4; M5; M6; M8; M10; M12	12

- GB Circular die
D Schneideisen
PL Narzynka
RUS Плашка
- CZ Kruhová závitová
čelist
H Menetvágó
RO Filieră
- F Filière
I Filiere tonde
filettatura
CN 圆板牙
- E Cojnete de roscar

SLIDING
CARD



YATO	size x pitch rozmiar x skok gwintu	outside diameter (mm) średnica zewnętrzna (mm)	thickness (mm) grubość (mm)	weight (g) waga (g)	
YT-2961	M4x0.7	20	5	20	125/500
YT-2962	M5x0.8	20	7	20	100/400
YT-2963	M6x1.0	20	7	20	100/400
YT-2964	M7x1.0	25	9	35	100/200
YT-2965	M8x1.25	25	9	35	100/400
YT-2967	M10x1.5	30	11	50	70/280
YT-2969	M12x1.75	38	14	90	60/240
YT-2970	M14x2.0	38	14	95	63/252

YATO	size x pitch rozmiar x skok gwintu	outside diameter (mm) średnica zewnętrzna (mm)	thickness (mm) grubość (mm)	weight (g) waga (g)	
YT-2971	M16x2.0	45	18	160	50/200
YT-2972	M18x2.5	45	18	160	50/200
YT-2973	M20x2.5	45	18	150	50/200
YT-2960	M22x2.5	55	22	300	20/80
YT-2966	M24x3.0	55	22	300	20/80
YT-2968	M27x3.0	65	25	400	15/60
YT-2974	M30x3.5	65	25	400	15/60

- GB Step drill
D Stufenbohrer
PL Wiertło stopniowe
RUS Сверло ступенчатое
CZ Stupňovitý vrták
H Lépcsős fűrő
RO Burghiu din titan cu gaurire in trepte

- F Étape de forage
I Punta da trapano graduata
E Broca cónica escalonada
CN 論杓耶

DOUBLE
BLISTER



HSS
4241

- GB Taper drill set
D Blechschildbohrer-Satz
PL Zestaw wiertel stożkowych
RUS Набор конусных сверл
CZ Sada kuželových vrtáků do plechu
H Részecs lemezfűrő készlet
RO Set alezoare in trepte
F Set de perceuse taper
I Set di punte coniche
E Conjunto brocas cónicas
CN 3件套薄板钻组套

BMC
& COLOR
SLEEVE



Ø mm
3-30

HSS
4241



12
STEPS
STOPNI

Ø mm
6-38



YATO	Ø (mm)	
YT-44740	6; 8; 11; 14; 17; 20; 23; 26; 29; 32; 35; 38	10/60

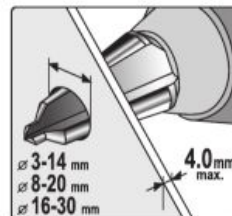

YATO	Ø (mm)	
YT-44730	3-14; 8-20; 16-30	10/30

10
STEPS
STOPNI

Ø mm
4-22



YATO	Ø (mm)	
YT-44741	4; 6; 8; 10; 12; 14; 16; 18; 20; 22	25/50

- GB Countersink
D Kegelsenker
PL Pogłębiacz
RUS Конусный зенкер
CZ Kuželový záhlubník
H Kúpos súlylesztő
- RO Zencuitor
F Fraise conique
I Accecatoio
E Avellanador cónico
CN 铤钻

SKIN
CARD



HSS
4241



YATO	Ø (mm)	L (mm)	
YT-44710	12.4	55	100/400

- GB T-handle tap wrench
 D Werkzeughalter für Gewinde
 PL Pokrętko typu „T” do gwintowników
 RUS Рукоятка типа „T” к гаечному ключу
 CZ Vratidlo na závitníky typ „T”
 H Menefűró befogó T-nyelű
 RO Port tarod cu maner
 F Porte-taraud type „T”
 I Chiave giramaschio tipo „T” per maschi
 E Llave giramachos „T”
 CN 丝锥铰手



SLIDING CARD

YATO	size / rozmiar	L (mm)	
YT-2986	M3-M8	70	20/80
YT-2987	M5-M10	80	20/80
YT-2988	M6-M12	90	20/80

- GB Ratchet tap wrench
 D Werkzeughalter
 PL Grzechotka do gwintownika
 RUS Трещетка для метчика
 CZ Řečtačka na závitník
 H Racsnis hajtószár menefűróhoz
 RO Port tarod
 F Porte-taraud à cliquet
 I Chiave giramaschi a cricchetto
 E Carraca para macho de roscar
 CN 棘轮丝锥铰手



SLIDING CARD

YATO	size / rozmiar	L (mm)	
YT-2989	M3-M10	85	20/80
YT-2997	M3-M10	250	20/80
YT-2990	M5-M12	100	20/80
YT-2991	M5-M12	300	20/40

- GB Die handle
 D Schneideisenhalter
 PL Oprawa do narzynie
 RUS Плашкодержатель
- CZ Závitová objímka
 H Menetvágó tartó
 RO Portfilieră
 F Porte-filière
- I Porta filiere
 E Portacojinete
 CN 板牙铰手



SLIDING CARD

DIN 225

YATO	size / rozmiar	Ø (mm)	L (mm)	
YT-2980	M3-M4	20x5	200	25/100
YT-2981	M4.5-M6	20x7	200	25/100
YT-2982	M7-M9	25x9	224	25/100
YT-2983	M10-M11	30x11	280	25/50
YT-2984	M12-M14	38x14	315	15/30
YT-2985	M16-M20	45x18	450	10/20

- GB Tap wrench
 D Werkzeughalter für Gewinde
 PL Pokrętko do gwintowników
- RUS Вороток для метчиков
 CZ Ovládací kolečko na závitník
 H Hajtószár menefűróhoz
- RO Cheie (mâner) pt. tarod
 F Porte-taraud
 I Manopola per il maschio
- E Llave giramachos
 CN 一型丝锥铰手



SLIDING CARD

DIN 1814

YATO	size / rozmiar	L (mm)	
YT-2995	M1-M8	125	50/200
YT-2996	M3-M10	180	25/100
YT-2992	M3-M12	200	25/100
YT-2993	M4-M12	280	25/100
YT-2994	M5-M20	375	20/40

- GB Thread repair set
 D Reparatursatz für Gewinde
 PL Zestaw do naprawy gwintów
 RUS Набор для ремонта резьбы
- CZ Souprava na opravu závitů
 H Menetjavító készlet
 RO Set pt. reparare filete
 F Set d'helicoils
- I Kit di riparazione per filettature
 E Juego para reparar roscas
 CN 螺纹修复组套



METAL BOX & COLOR BOX

HSS 4341

SS STAINLESS STEEL 15% NICKEL



88 PCS

YATO	size / rozmiar	
YT-1769	M6 x 1.0 x 10.8 mm	5/10
	M8 x 1.25 x 10.8 mm	
	M10 x 1.5 x 13.5 mm	



131 PCS

YATO	size / rozmiar	
YT-1763	M5 x 0.8 x 6.7 mm	5/10
	M6 x 1.0 x 10.8 mm	
	M8 x 1.25 x 10.8 mm	
	M10 x 1.5 x 13.5 mm	
	M12 x 1.75 x 16.3 mm	

- GB Wire threads
 D Spiraleinlagen für Gewindereparatur
 PL Wkłady spiralne do naprawy gwintów
 RUS Метчики и сверла для ремонта резьбы
- CZ Spirálové vložky na opravu závitů
 H Menetjavító betétek
 RO Inserții spirală pt. reparare filete
 F Helicoil
- I Inserti a spirale per riparazione
 E Elementos espirales para reparar roscas
 CN 螺纹修复组套

POLYBAG WITH HEADER



SS STAINLESS STEEL 15% NICKEL



for / dla: YT-1763, YT-1769

YATO	size / rozmiar	PCS packing	
YT-1764	M5 x 0.8 x 6.7 mm	20	50/250
YT-1765	M6 x 1.0 x 10.8 mm	20	50/250
YT-1766	M8 x 1.25 x 10.8 mm	20	50/200
YT-1767	M10 x 1.5 x 13.5 mm	15	25/100
YT-1768	M12 x 1.75 x 16.3 mm	10	25/100

- GB Rotary file
- D Profil-Fräser
- PL Tarnik trzpieniowy
- RUS Набор фасонных фрез
- CZ Hrotové rašple
- H Fareszelőkészlet, csapszárás
- RO Rașpeluri cu coadă
- F Fichiers rotary
- I Fresa a gradino per metallo
- E Arquivos rotary
- CN 旋转锉

BLISTER
CARD



0-2000
min⁻¹



YATO	Ø (mm)	
YT-61700	4-24	10/120

YATO	Ø (mm)	
YT-61701	6-15	10/120



YATO	Ø (mm)	
YT-61702	12	10/120

YATO	Ø (mm)	
YT-61703	6-15	10/120

YATO	Ø (mm)	
YT-61704	13	10/120



YATO	Ø (mm)	
YT-61705	15	10/120

YATO	Ø (mm)	
YT-61706	20	10/120

YATO	Ø (mm)	
YT-61707	25	10/120

- GB Rotary file set
- D Profil-Fräser Satz
- PL Tarniki trzpieniowe

- RUS Набор фасонных фрез
- CZ Hrotové rašple
- H Fareszelőkészlet, csapszárás

- RO Rașpeluri cu coadă
- F Ensemble de fichiers rotary
- I Set di raspe a perno

- E Conjunto de arquivos rotary
- CN 旋转锉

6
PCS



SLIDING CARD



YATO	Ø (mm)	
YT-61711	6	12/48

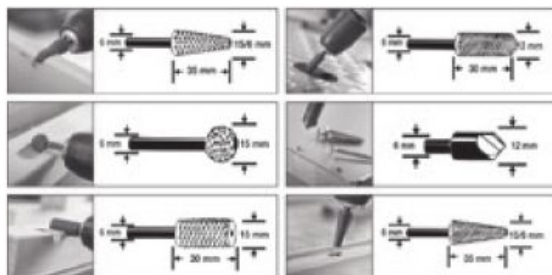

BLISTER
CARD



YATO	Ø (mm)	
YT-61712	6-15	10/60

- GB Router bit set
- D Oberfräsersatz
- PL Zestaw frezów do drewna
- RUS Набор фрез по дереву
- CZ Souprava frézů do dřeva
- H Medtjo frezj kompletas
- RO Set de freze pt. lemn
- F Fraises pour le bois
- I Set di frese per legno
- E Juego de frezas para madera
- CN 木工铣刀组套



ALUMINIUM CASE & COLOR SLEEVE

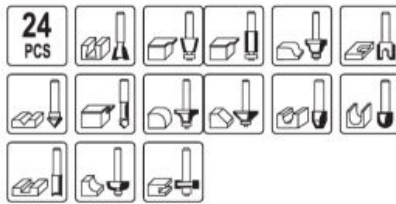

YATO
YT-6801 10

Router bit parameter												
Shank diameter [mm]	8	8	8	8	8	8	8	8	8	8	8	8
Length [mm]	42.0	47.0	47.0	43.5	50.0	51.5	51.0	52.0	58.0	51.5	58.0	56.5
Router bit diameter [mm]	12.7	12.7	9.5	12.7	12.7	9.5	12.7	16.0	6.35	6.35	9.5	12.7
Cutting edge length [mm]	12.7	14.8	11.6	13.0	12.5	20.0	20.0	9.5	19.5	20.0	24.5	25.0
Curvature radius [mm]	-	-	-	-	-	4.75	6.35	-	-	-	-	-
Bearing diameter [mm]	-	-	-	-	-	-	-	12.7	-	-	-	-
Angle [°]	-	15	10	-	45	-	-	15	-	-	-	-
Router bit parameter												
Shank diameter [mm]	8	8	8	8	8	8	8	8	8	8	8	8
Length [mm]	52.0	65.0	51.0	51.5	53.5	57.5	50.5	53.5	52.0	55.0	50.0	54.0
Router bit diameter [mm]	19.0	12.7	19.0	22.0	26.0	32.0	22.0	28.5	27.0	30.0	32.0	32.0
Cutting edge length [mm]	20.4	25.0	9.5	10.0	11.5	16.5	9.72	13.5	12.3	14.0	6.35	12.7
Curvature radius [mm]	-	-	3.2	4.76	6.35	9.5	6.35	9.5	4.0	-	-	-
Bearing diameter [mm]	-	12.7	-	12.7	12.7	12.7	9.5	9.5	9.5	12.7	12.7	12.7
Angle [°]	-	-	-	-	-	-	-	-	-	45	-	-



YATO
YT-6803 10

Router bit parameter																																							
Shank diameter [mm]	8	8	8	8	8	8	8	8	8	8	8	8	8	8	8	8	8	8	8	8	8	8	8	8	8	8	8	8	8	8	8	8	8	8	8	-			
Length [mm]	43.0	38.0	38.0	50.5	42.0	43.5	51.5	49.5	51.5	58.0	58.5	56.5	52.0	58.0	53.5	66.0	53.0	65.0	6.35	12.7	12.7	12.7	12.7	12.7	12.7	14.3	3.175	6.35	9.5	12.7	12.7	19.0	6.35	9.5	9.5	12.7	12.7		
Router bit diameter [mm]	6.35	12.7	12.7	12.7	12.7	12.7	14.3	3.175	6.35	9.5	12.7	12.7	19.0	6.35	9.5	9.5	12.7	12.7	6.0	9.5	9.5	18.0	12.7	13.0	12.3	13.0	20.0	24.5	20.3	25.0	20.4	19.5	15.0	26.0	15.0	25.0			
Cutting edge length [mm]	6.0	9.5	9.5	18.0	12.7	13.0	12.3	13.0	20.0	24.5	20.3	25.0	20.4	19.5	15.0	26.0	15.0	25.0	3.175	6.35	-	6.35	-	-	-	-	-	-	-	-	-	-	-	-	-	-	-		
Curvature radius [mm]	3.175	6.35	-	6.35	-	-	-	-	-	-	-	-	-	-	-	-	-	-	-	-	-	-	-	-	-	-	-	-	-	-	-	-	-	-	-	-	-	-	
Bearing diameter [mm]	-	-	-	-	-	-	-	-	-	-	-	-	-	-	-	-	-	-	-	-	-	-	-	-	-	-	-	-	-	-	-	-	-	-	-	-	-	-	
Angle [°]	-	-	45	-	-	10	14	-	-	-	-	-	-	-	-	-	-	-	-	-	-	-	-	-	-	-	-	-	-	-	-	-	-	-	-	-	-	-	
Router bit parameter																																							
Shank diameter [mm]	8	8	8	8	8	8	8	8	8	8	8	8	8	8	8	8	8	8	8	8	8	8	8	8	8	8	8	8	8	8	8	8	8	8	8	8	8	8	-
Length [mm]	65.5	55.0	51.0	55.0	50.0	52.5	54.0	55.5	60.0	60.0	56.0	60.0	52.5	58.0	53.5	57.5	61.0	-	26.0	14.0	9.7	13.3	6.35	8.0	9.5	15.0	18.5	20.0	16.0	19.0	12.5	17.8	11.5	16.5	20.8	-	-		
Router bit diameter [mm]	19.0	30.0	26.0	32.0	32.0	32.0	32.0	32.0	32.0	38.0	32.0	38.0	26.0	38.0	26.0	32.0	38.0	-	38.0	30.0	26.0	32.0	32.0	32.0	32.0	32.0	38.0	32.0	38.0	26.0	38.0	26.0	32.0	38.0	-	-	-	-	
Cutting edge length [mm]	26.0	14.0	9.7	13.3	6.35	8.0	9.5	15.0	18.5	20.0	16.0	19.0	12.5	17.8	11.5	16.5	20.8	-	38.0	30.0	26.0	32.0	32.0	32.0	32.0	38.0	32.0	38.0	26.0	38.0	26.0	32.0	38.0	-	-	-	-		
Curvature radius [mm]	-	-	6.35	9.5	-	-	-	8.0	4.76	12.7	4.76	6.35	3.175	6.35	6.35	9.5	12.7	-	38.0	30.0	26.0	32.0	32.0	32.0	32.0	38.0	32.0	38.0	26.0	38.0	26.0	32.0	38.0	-	-	-	-		
Bearing diameter [mm]	19.0	12.7	12.7	12.7	12.7	12.7	12.7	9.5	12.7	9.5	9.5	9.5	9.5	9.5	9.5	12.7	12.7	-	38.0	30.0	26.0	32.0	32.0	32.0	32.0	38.0	32.0	38.0	26.0	38.0	26.0	32.0	38.0	-	-	-	-		
Angle [°]	-	45	-	-	-	-	-	-	-	-	-	-	-	-	-	-	-	-	-	-	-	-	-	-	-	-	-	-	-	-	-	-	-	-	-	-	-	-	

GB Diamond blade
D Diamant-Trennscheibe
PL Tarcza diamentowa
RUS Отрезной алмазный диск
CZ Diamantový kotouč

H Gyémántkorong
RO Disc cu diamant
F Disque diamant

I Disco diamantato
E Disco de diamante
CN 金刚石切片

DOUBLE
BLISTER

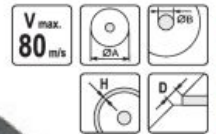

• application: concrete, brick, tile, masonry, stone, sandstone, refractory materials, limestone

• przeznaczenie: beton utwardzony, cegła, granit, mur, kamień, piaskowiec, materiały ogniotwale, silikaty

• application: ceramic, glaze

• przeznaczenie: płytki ceramiczne, glazura, płytki kamienne

YATO	øA (mm)	øB (mm)	Ø RPM.max.	D (mm)	H (mm)	☐
YT-59961	115	22.2	12000	1.8	10	200
YT-59962	125	22.2	12000	2.0	10	200
YT-59965	230	22.2	6500	2.2	10	25

YATO	øA (mm)	øB (mm)	Ø RPM.max.	D (mm)	H (mm)	☐
YT-59951	115	22.2	12000	1.6	10	200
YT-59952	125	22.2	12000	1.6	10	200
YT-59955	230	22.2	6500	2.2	10	25

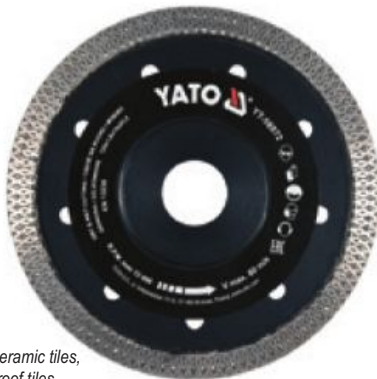

• application: ceramic, glaze, glass, porcelain, ceramic tiles, composite hardest tiles, roof tiles

• przeznaczenie: płytki ceramiczne, glazura, płytki kamienne, szkło, porcelana, ceramika, gres, dachówki

• application: reinforced concrete, glaze, clinker, brick, limestone

• przeznaczenie: beton zbrojony, granit, klinkier, silikaty

YATO	øA (mm)	øB (mm)	Ø RPM.max.	D (mm)	H (mm)	☐
YT-59971	115	22.2	12000	1.6	10	200
YT-59972	125	22.2	12000	1.6	10	200
YT-59975	230	22.2	6500	2.0	10	25

YATO	øA (mm)	øB (mm)	Ø RPM.max.	D (mm)	H (mm)	☐
YT-59981	115	22.2	12000	1.3	10	200
YT-59982	125	22.2	12000	1.3	10	200
YT-59985	230	22.2	6500	2.0	10	25

GB Diamond blade
D Diamant-Trennscheibe
PL Tarcza diamentowa
RUS Отрезной алмазный диск

CZ Diamantový kotouč
H Gyémántkorong
RO Disc cu diamant
F Disque diamant

I Disco diamantato
E Disco de diamante
CN 金刚石切片

DOUBLE
BLISTER



• application: concrete, brick, calcium-silicate brick, tile, masonry, stone

• przeznaczenie: beton utwardzony, cegła, cegła silikatowa, granit, mur, kamień

• application: ceramic, gres, glaze, glass, porcelain

• przeznaczenie: płytki ceramiczne, gres, glazura, płytki kamienne, szkło, porcelana

• application: concrete, reinforced concrete, brick, tile, masonry, stone, sandstone

• przeznaczenie: beton utwardzony, beton zbrojony, cegła, granit, mur, kamień, piaskowiec

YATO	øA (mm)	øB (mm)	Ø RPM.max.	D (mm)	H (mm)	☐
YT-6002	115	22.2	12000	2.1	8.0	20/200
YT-6003	125	22.2	11000	2.2	8.0	20/160
YT-6004	180	22.2	8000	2.5	8.0	15/60
YT-6005	230	22.2	6500	2.7	8.0	10/40

YATO	øA (mm)	øB (mm)	Ø RPM.max.	D (mm)	H (mm)	☐
YT-6012	115	22.2	12000	2.1	5.3	20/200
YT-6013	125	22.2	11000	2.2	5.3	20/160
YT-6014	180	22.2	8000	2.5	5.3	15/60
YT-6015	230	22.2	6500	2.7	5.3	10/40
YT-6016	180	25.4	8000	2.2	5.3	15/60
YT-6017	200	25.4	8000	2.2	5.3	10/40

YATO	øA (mm)	øB (mm)	Ø RPM.max.	D (mm)	H (mm)	☐
YT-6022	115	22.2	12000	2.4	8.0	20/200
YT-6023	125	22.2	11000	2.6	8.0	20/160
YT-6024	180	22.2	8000	2.8	8.0	15/60
YT-6025	230	22.2	6500	3.1	8.0	10/40

- GB Diamond grinding cup wheel
- D Diamant Schleiftopf Schleifteller
- PL Tarcza szlifierska diamentowa
- RUS Алмазный диск шлифовальный
- CZ Diamantový brusný kotouč
- H Gyémánt csiszoló kúpos
- RO Disc cupa diamentat pt. slefuit
- F Disque diamant
- I Disco diamantato
- E Disco diamante de lijár
- CN 金刚石杯型磨轮



HANGING COLOR BOX



- application: concrete, clinkier, natural stone, screed
- przeznaczenie: beton utwardzony, klinkier, kamień naturalny, jastrych

YATO	ØA (mm)	ØB (mm)	R.P.M.max.	segment size (mm)	
YT-6030	125	22.2	12200	5.0x7.5	20
YT-6032	125	22.2	12200	4.5x20.0	20

- GB Diamond core bit drilling holes for sockets
- D Diamant-Bohrkrone
- PL Diamentowe wiertło koronowe
- RUS Алмазное сверло корончатое
- CZ Diamantový korunkový vrták
- H Gyémánt fúrókorona
- RO Carota diamentata pt. beton
- F Trépiéd à mur diamantées
- I Corona diamantata per calcestruzzo
- E Corona con broca diamante
- CN 金刚石薄壁钻



COLOR BOX



- application: concrete, calcium-silicate brick, porous ceramics
- przeznaczenie: beton utwardzony, cegła silikatowa, ceramika poryzowana

YATO	Ø (mm)	R.P.M.max.	segment size (mm)	
YT-6045	68	1030	3.5x10x24	24
YT-6046	82	850	3.5x10x24	20

10

- GB TCT circular saw blade for wood
- D Kreissägeblatt HM-Bestück
- PL Pila tarczowa do drewna z węglikiem wolframu
- RUS Диск пильный с карбидом вольфрама
- CZ Kotoučová pila na dřevo z karbidem wolframu
- H Wolframkarbidos körfűrész fához
- RO Ferăstrău circular cu dinți din wolfram pt. lemn
- F Lame de scie circulaire carburée
- I Lama tronatrice taglio legno
- E Disco de sierra con carbono de tungsteno
- CN 木工锯片



DOUBLE BLISTER



- application: for cutting wood and plastics
- przeznaczenie: do cięcia drewna, płyt drewnopochodnych, tworzyw sztucznych

YATO	Ø (mm)	d (mm)	R.P.M.max.	D (mm)	metal disc thickness / grubość tarczy (mm)	number of teeth / ilość zębów (T)	
YT-6050	130	16.0	10000	2.8	2.0	24	25/50
YT-6052	140	20.0	10000	2.8	2.0	16	25/50
YT-60522	140	20.0	11000	2.8	2.0	30	25/50
YT-6053	140	16.0	10000	2.8	2.0	30	25/50
YT-60533	150	20.0	10000	2.8	2.0	30	25/50
YT-6055	160	20.0	9500	2.8	2.0	18	25/50
YT-6056	160	30.0	9500	2.8	2.0	24	25/50
YT-6057	160	30.0	9500	2.8	2.0	36	25/50
YT-6058	160	20.0	9500	2.8	2.0	48	25/50
YT-60582	170	16.0	9500	3.2	2.2	12	25/50
YT-60583	170	16.0	9500	3.2	2.2	40	25/50
YT-6060	184	30.0	9000	3.2	2.2	24	25/50
YT-6061	184	30.0	9000	3.2	2.2	40	25/50
YT-6062	184	30.0	9000	3.2	2.2	50	25/50
YT-6063	185	20.0	9000	2.4	1.4	18	25/50
YT-60633	190	16.0	8500	3.2	2.2	40	10/20
YT-60634	190	20.0	7100	2.2	1.5	24	25/50
YT-60488	190	30.0	8500	3.2	2.2	20	10/20
YT-60489	190	30.0	8500	3.2	2.2	40	10/20
YT-6065	200	30.0	8000	3.2	2.2	24	10/20
YT-60652	210	30.0	8000	3.2	2.2	40	10/20
YT-6066	205	18.0	6000	3.2	2.0	24	10/20

YATO	Ø (mm)	d (mm)	R.P.M.max.	D (mm)	metal disc thickness / grubość tarczy (mm)	number of teeth / ilość zębów (T)	
YT-60665	210	30.0	7500	3.2	2.2	20	10/20
YT-60668	235	25.5	5800	2.5	1.8	24	25
YT-6067	210	30.0	8000	3.2	2.2	40	10/20
YT-6068	210	30.0	8000	3.2	2.2	60	10/20
YT-60682	216	30.0	7500	3.2	2.2	48	10/20
YT-6070	250	30.0	6000	3.2	2.2	24	10/20
YT-6071	250	30.0	6000	3.2	2.2	40	10/20
YT-6072	250	30.0	6000	3.2	2.2	60	10/20
YT-6075	300	30.0	6000	3.2	2.2	24	10
YT-6076	300	30.0	5000	3.2	2.2	40	10
YT-6077	300	30.0	5000	3.2	2.2	60	10
YT-6078	300	30.0	5000	3.2	2.2	96	10
YT-60790	315	30.0	4500	3.5	2.5	24	10
YT-60792	315	30.0	4500	3.5	2.5	48	10
YT-60794	315	30.0	4500	3.5	2.5	80	10
YT-6080	350	30.0	4500	3.5	2.5	28	10
YT-6081	350	30.0	4500	3.5	2.5	40	10
YT-6082	350	30.0	4500	3.5	2.5	54	10
YT-6083	350	30.0	4500	3.5	2.5	84	10
YT-6085	400	30.0	4000	3.8	2.8	32	10
YT-6086	400	30.0	4000	3.8	2.8	60	10

- GB TCT circular saw blade for structural wood
D Kreissägeblatt HM-Bestück von Holzkonstruktionen
PL Pila tarczowa z węglikiem wolframu do cięcia drewna konstrukcyjnego
RUS Диск пильный твердого сплава для резки строительной конструкционной древесины

- CZ Kotočová pila s karbidem wolframu k řezání konstrukčního dřeva
H Wolfram-karbid szegmens fűrészárcsa szerkezeti fához
RO Ferăstrău circular cu dinți din wolfram pt. tăierea lemnului pt. construcții

- F lame de scie circulare carbure pour construction bois
I Lama al tungsteno da legno
E Disco de sierra con carbono de tungsteno para corte de madera estructural
CN 木工圆锯片

DOUBLE
BLISTER



YATO	Ø (mm)	d (mm)	RPM _{max}	D (mm)	metal disc thickness / grubość tarczy (mm)	number of teeth / ilość zębów (T)	
YT-60480	160	20	9500	2.2	1.5	24	25/50
YT-60482	180	20	9000	2.4	1.8	36	20/40
YT-60484	250	30	6000	2.4	1.8	48	10/20

YATO	Ø (mm)	d (mm)	RPM _{max}	D (mm)	metal disc thickness / grubość tarczy (mm)	number of teeth / ilość zębów (T)	
YT-60628	185	20	9000	2.4	1.8	14	25/50

- GB Blade for cutting laminate and plywood
D Kreissägeblatte für Laminatböden
PL Pila tarczowa do cięcia paneli i płyt meblowych
RUS Ламинированный режущий диск
CZ Laminátový řezací kotoč
H Körfűrészlap
RO Disc de tăiere laminat
F Disque de coupe en stratifié
I Disco da taglio per pannelli e pannelli per mobili
E Disco de corte laminado
CN 普通木工片

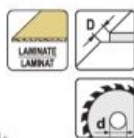

DOUBLE
BLISTER



YATO	Ø (mm)	d (mm)	RPM _{max}	D (mm)	metal disc thickness / grubość tarczy (mm)	number of teeth / ilość zębów (T)	
YT-60631	185	20	9000	1.7	1.4	140	25/50

- GB Metal cutting blade for circular saw
D Kreissägeblatt für Geradschnitte in Edelstahl
PL Pila tarczowa do cięcia stali ręczną pilarką tarczową
RUS Диск циркулярной пилы для стали
CZ Kruhová pila na řezání kovu
H Fűrészárcsa fém vágáshoz
RO Panza fierastrau circular pt. debitat metal
F lame scie circulare
I Disco in carburo da taglio dell'acciaio
E Sierra circular para cortar metal
CN 锯铁片

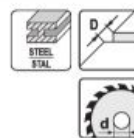

DOUBLE
BLISTER



YATO	Ø (mm)	d (mm)	RPM _{max}	D (mm)	metal disc thickness / grubość tarczy (mm)	number of teeth / ilość zębów (T)	
YT-60625	185	20	6000	2.2	1.5	48	25/50

- GB TCT circular saw blade for aluminium
D Hartmetallbestückt Kreissägeblatt für Aluminium
PL Pila tarczowa do aluminium z węglikiem wolframu
RUS Диск пильный по алюминию
CZ Kotočová pila na hliník s karbidem wolframu
H Wolframkarbidos körfűrészlap, alumíniumhoz
RO Disc circular pt. aluminiu
F lame de scie circulare pour aluminium
I Lama tronatrice alluminio
E Disco de sierra con carbono
CN 锯片



DOUBLE
BLISTER



- application: for cutting aluminium profiles, laminates, plexi, corian and other plastics
- negative angle of teeth
- przeznaczenie: do cięcia profili aluminiowych, laminatów, plexi, korianu, tworzyw sztucznych
- negatywny kąt natarcia zębów

YATO	Ø (mm)	d (mm)	RPM _{max}	D (mm)	metal disc thickness / grubość tarczy (mm)	number of teeth / ilość zębów (T)	
YT-60905	160	20	9500	2.2	1.5	52	25/50
YT-60907	180	20	9000	2.2	1.5	60	20/40
YT-6091	200	30	8000	3.0	2.2	60	10/20
YT-6093	210	30	8000	3.0	2.2	72	10/20
YT-6095	250	30	6000	3.0	2.2	100	10/20
YT-6097	300	30	5000	3.0	2.2	100	10
YT-6099	350	30	4500	3.2	2.5	100	10

- GB PVC cutting blade
D PVC-Trennscheibe
PL Pila tarczowa do cięcia PCV
RUS Режущий диск ПВХ
CZ PVC řezný disk
H Körfűrészárcsa
RO Panza de ferastrau circular PVC
F Disque de coupe en PVC
I Disco da taglio per PVC
E Sierra circular CMT para corte PVC
CN 锯塑片



DOUBLE
BLISTER



YATO	Ø (mm)	d (mm)	RPM _{max}	D (mm)	metal disc thickness / grubość tarczy (mm)	number of teeth / ilość zębów (T)	
YT-60627	185	20	9000	2.5	1.5	60	25/50

- GB Metal cutting disc
 D Trennscheibe für Metall
 PL Tarcza do cięcia metalu
 RUS Диск отрезной по металлу
 CZ Kotouč pro řezání kovu
 H Vágókorong fémhez
 RO Disc debitat metale
 F Lame de scie pour métaux
 I Disco per taglio metallo
 E Disco cortador para metalo
 CN 锯片



- GB Metal cutting disc
 D Trennscheibe für Metall
 PL Tarcza do cięcia metalu
 RUS Диск отрезной по металлу
 CZ Kotouč pro řezání kovu
 H Vágókorong fémhez
 RO Disc debitat metale
 F Lame de scie pour métaux
 I Disco per taglio metallo
 E Disco cortador para metalo
 CN 锯片



for / dla: YT-82180

YATO	øA (mm)	øB (mm)	D (mm)	R.P.M.max.	PCS packing
YT-61132	355	25.4	3.2	4400	25

INOX
 STAINLESS STEEL
 OTEL NERZOVINA

YATO	øA (mm)	øB (mm)	D (mm)	R.P.M.max.	PCS packing
YT-6101	115	22	1.2	13200	5 25/200
YT-6103	125	22	1.2	12200	5 25/200
YT-6104	125	22	2.5	12200	5 25/200
YT-6105	180	22	1.5	8600	5 25/50
YT-6107	230	22	2.0	6500	5 25/50

YATO	øA (mm)	øB (mm)	D (mm)	R.P.M.max.	PCS packing
YT-5920	115	22	1.2	13200	5 25/200
YT-5921	115	22	2.5	13200	5 25/200
YT-5923	125	22	1.2	12200	5 25/200
YT-5924	125	22	2.5	12200	5 25/200
YT-6110	125	22	3.2	12200	5 25/200
YT-5925	180	22	1.5	8600	5 25/50
YT-5926	180	22	2.5	8600	5 25/50
YT-5927	230	22	2.0	6500	5 25/50
YT-6112	230	22	3.2	6500	5 25/50
YT-6113	300	32	3.2	5100	5 25
YT-6136	350	32	3.5	4400	5 25
YT-6137	400	32	4.0	3800	5 25

- GB Metal cutting disc
 D Trennscheibe für Metall
 PL Tarcza do cięcia metalu
 RUS Диск отрезной по металлу
 CZ Kotouč pro řezání kovu
 H Vágókorong fémhez
 RO Disc debitat metale
 F Lame de scie pour métaux
 I Disco per taglio metallo
 E Disco cortador para metalo
 CN 锯片

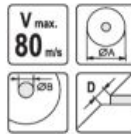

- depressed center
- wypukła

YATO	øA (mm)	øB (mm)	D (mm)	R.P.M.max.	PCS packing
YT-6116	125	22	2.5	12200	5 25/200
YT-6120	230	22	3.2	6500	5 25/50

- GB Metal grinding disc
 D Metall-Schleifscheibe
 PL Tarcza do szlifowania metalu
 RUS Круги для шлифования по металлу
 CZ Kotouč pro broušení kovu
 H Vágókorong fémhez
 RO Disc pt. șlefuit metal
 F Disque de polissage pour métaux
 I Disco per rettifica metallo
 E Disco cortador para metalo
 CN 锯片



- depressed center
- wypukła

YATO	øA (mm)	øB (mm)	D (mm)	R.P.M.max.	PCS packing
YT-6121	115	22	6.0	13200	5 25/100
YT-6124	125	22	6.0	12200	5 30/120
YT-6126	125	22	8.0	12200	5 25/100
YT-6138	180	22	6.8	8600	5 15/30
YT-6125	230	22	6.0	6500	5 5/30

INOX
 STAINLESS STEEL
 OTEL NERZOVINA



- depressed center
- wypukła

YATO	øA (mm)	øB (mm)	D (mm)	R.P.M.max.	PCS packing
YT-5947	125	22	6.8	12200	5 25/100

- GB Stone cutting disc
 D Trennscheibe für Stein
 PL Tarcza do cięcia kamienia
 RUS Диск отрезной по камню
 CZ Kotouč pro řezání kamene
 H Vágókorong kőhöz
 RO Disc pt. tăiat piatră
 F Disque de coupe pour granit
 I Disco per taglio pietra
 E Disco cortador de piedra
 CN 石材锯片

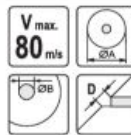

YATO	øA (mm)	øB (mm)	D (mm)	R.P.M.max.	PCS packing
YT-5930	115	22	1.5	13200	5 25/200
YT-5932	125	22	1.5	12200	5 25/200
YT-5933	125	22	3.2	12200	5 25/200
YT-5935	230	22	3.2	6500	5 25/50

- GB Stone grinding disc
 D Stein-schleifscheibe
 PL Tarcza do szlifowania kamienia
 RUS Диск для шлифования по камню
 CZ Kotouč pro broušení kamene
 H Csiszolókorong kőhöz
 RO Disc pt. șlefuit piatră
 F Disque de polissage pour granit
 I Disco per rettifica pietra
 E Disco cortador de piedra
 CN 锯片

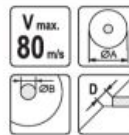

- depressed center
- wypukła

YATO	øA (mm)	øB (mm)	D (mm)	R.P.M.max.	PCS packing
YT-6132	115	22	6.0	13200	5 25/100
YT-6133	125	22	6.8	12200	5 25/100

- GB Rubber disc for angle grinder
 D Klett-Gummihafstüttsteller mit Gewindeflansch
 PL Przystawka do szlifierek kątowych
 RUS Диск резиновый с липучкой для шлифмашин
 CZ Euro disk do úhelníků ze zipem
 H Csiszolókorong kőhöz
 RO Suport disc pt. polizor unghiular
 F Disque caoutchouc avec velcro
 I Disco con velcro e accessori
 E Disco de goma para angul con velcro
 CN 抛光垫



POLYBAG WITH HEADER

YATO	ø (mm)	R.P.M.max.
YT-4770	230	6600

GB Saw rasp
D Sägeblatt für Einhandschleifer
PL Piła tarnikowa
RUS Диск фрезы универсальный
CZ Rotační rašple
H Rotációs ráspoly
RO Disc raspe
F Disque de coupe
I Disco raspa a sega
E Disco de corte
CN 锯锉刀



- cutting, ridging
- wood, cellular concrete, plastics, gypsum, drywall
- cięcie, bruzdowanie
- drewno, beton komórkowy, tworzywo sztuczne, gips, płyty gipsowo-kartonowe

YATO	Ø (mm)	d (mm)	R.P.M.max.	D (mm)	#
YT-59160	115	22.2	13000	5	10
YT-59161	125	22.2	13000	5	10
YT-59163	230	22.2	8000	5	5

GB Tapered rasp disc
D Raspelscheibe schräge Oberfläche
PL Tarnik skośny
RUS Диск фрезы универсальный по дереву для УШМ
CZ Rotační rašple
H Rotációs ráspoly
RO Disc raspe conic
F Disque râpe
I Disco raspa obliquo
E Disco escofina
CN 圆锥锉刀盘

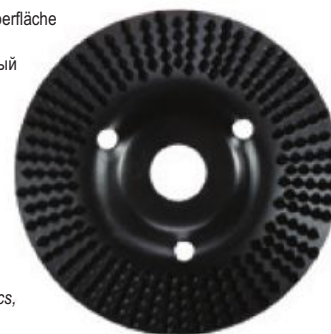

- grinding, milling
- wood, cellular concrete, plastics, gypsum, drywall
- szlifowanie, frezowanie
- drewno, beton komórkowy, tworzywo sztuczne, gips, płyty gipsowo-kartonowe

YATO	Ø (mm)	d (mm)	R.P.M.max.	#
YT-59164	115	22.2	13000	2
YT-59165	125	22.2	13000	2

GB Tapered rasp disc
D Raspelscheibe schräge Oberfläche
PL Tarnik skośny
RUS Диск фрезы универсальный по дереву для УШМ
CZ Rotační rašple
H Rotációs ráspoly
RO Disc raspe conic
F Disque râpe
I Disco raspa obliquo
E Disco escofina
CN 圆锥锉刀盘

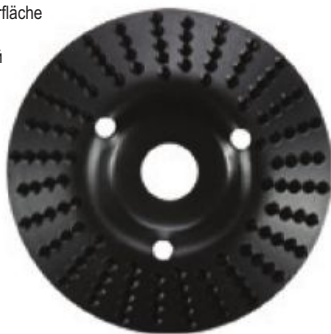

- grinding, milling
- wood, cellular concrete, plastics, gypsum, drywall
- szlifowanie, frezowanie
- drewno, beton komórkowy, tworzywo sztuczne, gips, płyty gipsowo-kartonowe

YATO	Ø (mm)	d (mm)	R.P.M.max.	#
YT-59166	115	22.2	13000	1
YT-59167	125	22.2	13000	1

GB Tapered rasp disc
D Raspelscheibe gekröpft
PL Tarnik wypukły
RUS Диск фрезы универсальный по дереву для УШМ
CZ Rotační rašple
H Rotációs ráspoly
RO Disc raspe conic
F Disque râpe
I Disco raspa convesso
E Disco escofina
CN 锯片



- grinding, milling
- wood, cellular concrete, plastics, gypsum, drywall
- szlifowanie, frezowanie
- drewno, beton komórkowy, tworzywo sztuczne, gips, płyty gipsowo-kartonowe

YATO	Ø (mm)	d (mm)	R.P.M.max.	#
YT-59168	125	22.2	13000	1
YT-59169	125	22.2	13000	2
YT-59170	125	22.2	13000	3

GB Saw rasp
D Raspelscheibe mit Säge
PL Tarnik z piłą
RUS Диск фрезы универсальный по дереву для УШМ
CZ Rotační rašple
H Rotációs ráspoly
RO Disc raspe
F Disque râpe
I Disco raspa a sega
E Disco escofina
CN 锯片



- cutting, ridging, grinding, milling
- wood, cellular concrete, plastics, gypsum, drywall
- cięcie, bruzdowanie, szlifowanie, frezowanie
- drewno, beton komórkowy, tworzywo sztuczne, gips, płyty gipsowo-kartonowe

YATO	Ø (mm)	d (mm)	R.P.M.max.	D (mm)	#
YT-59171	115	22.2	13000	5	1
YT-59172	125	22.2	13000	5	1

GB Saw rasp tapered fine
D Raspelscheibe gekröpft mit Säge
PL Tarnik wypukły z piłą
RUS Диск фрезы универсальный по дереву для УШМ
CZ Rotační rašple
H Rotációs ráspoly
RO Disc raspe conic
F Disque râpe
I Disco raspa convesso con sega
E Disco escofina
CN 锯片



- cutting, ridging, grinding, milling
- wood, cellular concrete, plastics, gypsum, drywall
- cięcie, bruzdowanie, szlifowanie, frezowanie
- drewno, beton komórkowy, tworzywo sztuczne, gips, płyty gipsowo-kartonowe

YATO	Ø (mm)	d (mm)	R.P.M.max.	D (mm)	#
YT-59173	115	22.2	13000	5	1
YT-59174	125	22.2	13000	5	1

GB Rasp milling cutter
D Raspelräs-Scheibe
PL Frez tarnikowy
RUS Фреза по дереву для УШМ
CZ Rotační rašple
H Rotációs ráspoly
RO Disc raspe conic
F Fraise râpe



- milling, ridging
- wood, cellular concrete, plastics, gypsum, drywall
- frezowanie, bruzdowanie
- drewno, beton komórkowy, tworzywo sztuczne, gips, płyty gipsowo-kartonowe

YATO	Ø (mm)	d (mm)	R.P.M.max.	milling cutter height / wysokość frezu (mm)	#
YT-59175	90	22.2	13000	21	10
YT-59176	118	22.2	13000	21	10

GB Rasp milling cutter
D Raspelräs Universalscheibe
PL Frez tarnikowy uniwersalny
RUS Фреза по дереву для УШМ
CZ Rotační rašple
H Rotációs ráspoly
RO Disc raspe conic
F Fraise râpe

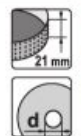

- milling, grinding, ridging
- wood, cellular concrete, plastics, gypsum, drywall
- frezowanie, szlifowanie, bruzdowanie
- drewno, beton komórkowy, tworzywo sztuczne, gips, płyty gipsowo-kartonowe

YATO	Ø (mm)	d (mm)	R.P.M.max.	milling cutter height / wysokość frezu (mm)	#
YT-59177	118	22.2	13000	21	1

GB Cable cutter
 D Kabelschere
 PL Szczypce do cięcia przewodów
 RUS Кабелперезы
 CZ Elektrické upichovákы
 H Kábelvágó
 RO Patent tăietor pt. electrice
 F Pince à couper les fils
 I Pinze per tagliare i cavi
 E Tijeras para cables
 CN 电缆剪



SLIDING CARD

160 mm	210 mm
240 mm	HRC 55-60

CrV 50
 DROP FORGED STEEL
 STAL KUTA NA ZIMNO

YATO	L (mm)	max. Ø (mm)	
YT-1966	160	6	6/60
YT-1967	210	7	6/60
YT-1968	240	8	6/48

GB Insulated cable cutter
 D Kabelschere
 PL Szczypce do cięcia przewodów izolowane
 RUS Кабелперезы
 CZ Elektrické upichovákы, izolované
 H Kábelvágó
 RO Cleste taiat cabluri izolat
 F Pince renforcée isolée
 I Pinze per tagliare i cavi isolati
 E Tijeras para cables aislantes
 CN 绝缘电缆剪



250 mm CrV 1000 V DYE

POLYBAG

YATO	L (mm)	max. Ø (mm)	
YT-21141	250	80	6/36

1000V VDE CERTIFICATE EN 60900:2012

GB Heavy duty cable cutter
 D Schwere Drahtschere
 PL Wzmocnione nożyce do cięcia przewodów
 RUS Кабелперезы
 CZ Elektrické upichovákы
 H Kábelvágó
 RO Patent tăietor pt. electrice



F Pince renforcée à couper les fils
 I Pinze per tagliare i cavi

E Tijeras para cables
 CN 电缆剪

SLIDING CARD 240 mm CrV 50 HRC 55-60

YATO	L (mm)	max. Ø (mm)	
YT-1969	240	9	6/48

• application: for copper and aluminium electric cables
 • przeznaczenie: do cięcia miedzianych i aluminiowych kabli

GB Heavy duty cable cutter
 D Schwere Drahtschere
 PL Wzmocnione nożyce do cięcia przewodów
 RUS Кабелперезы
 CZ Elektrické upichovákы
 H Kábelvágó
 RO Patent tăietor pt. electrice
 F Pince renforcée à couper les fils
 I Pinze per tagliare i cavi
 E Tijeras para cables
 CN 电缆剪



SLIDING CARD 230 mm HRC 58-61 CrMo

Lever for increase cutting power
 Ideal for copper and aluminium electric cables

YATO	L (mm)	max. Ø (mm)	
YT-1933	230	9	6/36

GB Tin snips
 D Blechschere
 PL Nożyce do cięcia blachy

RUS Ножницы по металлу
 CZ Nůžky na plech
 H Lemezvágó olló

RO Foarfece pt. tablă
 F Cisaille à tôle
 I Cesioie per lamiera

E Tijeras para chapas
 CN 铁皮剪

SLIDING CARD LEFT CUT CIĘCIE LEWE CrMo INCREASED CUTTING POWER ZWIĘKSZONA SIŁA CIĘCIA



HRC 60-62
 DIN 6438

YATO	L (mm)	cutting length (mm)	cutting capacities (mm)				
			copper	cold-rolled steel	hard steel HRC35	stainless steel 304	
YT-1910	260	35	1.80	1.50	1.00	0.90	6/36



HRC 60-62
 DIN 6438

YATO	L (mm)	cutting length (mm)	cutting capacities (mm)				
			copper	cold-rolled steel	hard steel HRC35	stainless steel 304	
YT-1915	235	30	1.50	1.20	1.00	0.70	6/36



HRC 60-62
 DIN 6438

YATO	L (mm)	cutting length (mm)	cutting capacities (mm)				
			copper	cold-rolled steel	hard steel HRC35	stainless steel 304	
YT-1918	260	32	1.80	1.50	1.00	0.90	6/36



HRC 56-62
 BERRATED EDGES ZARŹYCHANA KRAWĘDZ OSTRZY
 HIGH FREQUENCY HARDENING HARTOWANIE MPULSOWE

YATO	L (mm)	cutting length (mm)	cutting capacities (mm)				
			copper	cold-rolled steel	hard steel HRC35	stainless steel 304	
YT-1960	250	40	2.00	1.50	1.00	0.80	6/36

GB Tin snips
D Blechscher
PL Nożyce do cięcia blachy
RUS Ножницы по металлу
CZ Nůžky na plech
H Lemezvágó olló
RO Foarfece pt. tablă
F Cisaille à tôle
I Cesioie per lamiera
E Tijeras para chapas
CN 铁皮剪



SLIDING CARD



LEFT CUT
CIECIE LEWE

HRC 60-62

CrMo

90°

SERRATED EDGES
ZĄBOWANA KRAWĘDZ OSTRZY



YATO	L (mm)	cutting length (mm)	cutting capacities (mm)				6/36
			copper	cold-rolled steel	hard steel HRC35	stainless steel 304	
YT-1913	225	30	0.78	0.53	0.46	0.36	6/36

GB Tin snips
D Blechscher
PL Nożyce do cięcia blachy
RUS Ножницы по металлу

CZ Nůžky na plech
H Lemezvágó olló
RO Foarfece pt. tablă
F Cisaille à tôle

I Cesioie per lamiera
E Tijeras para chapas
CN 铁皮剪

SLIDING CARD



STRAIGHT CUT
CIECIE PROSTE

CrMo

INCREASED CUTTING POWER
ZWIĘKSZONA SIŁA CIĘCIA



HRC 60-62

DIN 6438

HRC 60-62

DIN 6438

YATO	L (mm)	cutting length (mm)	cutting capacities (mm)				6/36
			copper	cold-rolled steel	hard steel HRC35	stainless steel 304	
YT-1912	260	35	1.80	1.50	1.00	0.90	6/36

YATO	L (mm)	cutting length (mm)	cutting capacities (mm)				6/36
			copper	cold-rolled steel	hard steel HRC35	stainless steel 304	
YT-1922	290	75	1.10	0.94	0.70	0.53	6/36

HRC 60-62

DIN 6438



HRC 56-62

SERRATED EDGES
ZĄBOWANA KRAWĘDZ OSTRZY

HIGH FREQUENCY HARDENING
HARTOWANE IMPULSOWE

YATO	L (mm)	cutting length (mm)	cutting capacities (mm)				6/36
			copper	cold-rolled steel	hard steel HRC35	stainless steel 304	
YT-1923	230	25	2.00	1.60	1.20	1.20	6/36

YATO	L (mm)	cutting length (mm)	cutting capacities (mm)				6/36
			copper	cold-rolled steel	hard steel HRC35	stainless steel 304	
YT-1962	250	45	2.00	1.50	1.00	0.80	6/36

GB Tin snips
D Blechscher
PL Nożyce do cięcia blachy
RUS Ножницы по металлу

CZ Nůžky na plech
H Lemezvágó olló
RO Foarfece pt. tablă
F Cisaille à tôle

I Cesioie per lamiera
E Tijeras para chapas
CN 铁皮剪

SLIDING CARD



RIGHT CUT
CIECIE PRAWIE

CrMo

INCREASED CUTTING POWER
ZWIĘKSZONA SIŁA CIĘCIA

HRC 60-62

DIN 6438



HRC 60-62

DIN 6438

YATO	L (mm)	cutting length (mm)	cutting capacities (mm)				6/36
			copper	cold-rolled steel	hard steel HRC35	stainless steel 304	
YT-1911	260	35	1.80	1.50	1.00	0.90	6/36

YATO	L (mm)	cutting length (mm)	cutting capacities (mm)				6/36
			copper	cold-rolled steel	hard steel HRC35	stainless steel 304	
YT-1916	235	30	1.50	1.20	1.00	0.70	6/36

HRC 60-62

DIN 6438



HRC 56-62

SERRATED EDGES
ZĄBOWANA KRAWĘDZ OSTRZY

HIGH FREQUENCY HARDENING
HARTOWANE IMPULSOWE

YATO	L (mm)	cutting length (mm)	cutting capacities (mm)				6/36
			copper	cold-rolled steel	hard steel HRC35	stainless steel 304	
YT-1919	260	32	1.80	1.50	1.00	0.90	6/36

YATO	L (mm)	cutting length (mm)	cutting capacities (mm)				6/36
			copper	cold-rolled steel	hard steel HRC35	stainless steel 304	
YT-1961	250	40	2.00	1.50	1.00	0.80	6/36

GB Tin snips
D Blechscher
PL Nożyce do cięcia blachy
RUS Ножницы по металлу
CZ Nůžky na plech
H Lemezvágó olló
RO Foarfece pt. tablă
F Cisaille à tôle
I Cesioie per lamiera
E Tijeras para chapas
CN 铁皮剪



SLIDING CARD



RIGHT CUT
CIECIE PRAWIE

HRC 60-62

CrMo

90°

SERRATED EDGES
ZĄBOWANA KRAWĘDZ OSTRZY



YATO	L (mm)	cutting length (mm)	cutting capacities (mm)				6/36
			copper	cold-rolled steel	hard steel HRC35	stainless steel 304	
YT-1914	225	30	0.78	0.53	0.46	0.36	6/36

- GB Tin snips
- D Blechscherer
- PL Nożyce do cięcia blachy
- RUS Ножницы по металлу
- CZ Nůžky na plech
- H Lemezvágó olló
- RO Foarfece pt. tablă
- F Cisaille à tôle
- I Cesioie per lamiera
- E Tijeras para chapas
- CN 铁皮剪



SLIDING CARD



LEFT CUT
CIECIE
LEWE

DROP FORGED
KUTE

HRC 58-61

YATO	L (mm)	cutting length (mm)	cutting capacities (mm)				6/24
			copper	cold-rolled steel	hard steel HRC35	stainless steel 304	
YT-1900	260	30	0.94	0.78	0.60	0.45	6/24

- GB Tin snips
- D Blechscherer
- PL Nożyce do cięcia blachy
- RUS Ножницы по металлу

- CZ Nůžky na plech
- H Lemezvágó olló
- RO Foarfece pt. tablă
- F Cisaille à tôle

- I Cesioie per lamiera
- E Tijeras para chapas
- CN 铁皮剪

SLIDING CARD



RIGHT CUT
CIECIE
PRAWO

DROP FORGED
KUTE

HRC 58-61



YATO	L (mm)	cutting length (mm)	cutting capacities (mm)				6/24
			copper	cold-rolled steel	hard steel HRC35	stainless steel 304	
YT-1901	260	30	0.94	0.78	0.60	0.45	6/24

YATO	L (mm)	cutting length (mm)	cutting capacities (mm)				6/24
			copper	cold-rolled steel	hard steel HRC35	stainless steel 304	
YT-1902	300	50	0.94	0.78	0.60	0.45	6/24

- GB Tin snips
- D Blechscherer
- PL Nożyce do cięcia blachy
- RUS Ножницы по металлу
- CZ Nůžky na plech
- H Lemezvágó olló
- RO Foarfece pt. tablă
- F Cisaille à tôle
- I Cesioie per lamiera
- E Tijeras para chapas
- CN 铁皮剪

SLIDING CARD



S55C
DROP FORGED
STEEL
STAL KUTA
NA ZIMNO

HRC 55-60

HIGH FREQUENCY
HARDENING
HARTOWANIE
IMPULSOWE



YATO	L (mm)	cutting length (mm)	cutting capacities (mm)				6/36
			copper	cold-rolled steel	hard steel HRC35	stainless steel 304	
YT-1970	260	42	2.0	1.4	1.0	1.0	6/36

- GB Tin snips
- D Blechscherer
- PL Nożyce do cięcia blachy
- RUS Ножницы по металлу
- CZ Nůžky na plech
- H Lemezvágó olló
- RO Foarfece pt. tablă
- F Cisaille à tôle
- I Cesioie per lamiera
- E Tijeras para chapas
- CN 铁皮剪



SLIDING CARD



For cutting straight and tight curves left or right

HRC 58-61

YATO	L (mm)	cutting length (mm)	cutting capacities (mm)				6/36
			copper	cold-rolled steel	hard steel HRC35	stainless steel 304	
YT-1925	225	52	0.94	0.78	0.60	0.45	6/36

HRC 58-60

YATO	L (mm)	cutting length (mm)	cutting capacities (mm)				6/36
			copper	cold-rolled steel	hard steel HRC35	stainless steel 304	
YT-1920	260	42	1.20	1.00	0.60	0.50	6/36

- GB Tin snips
- D Blechscherer
- PL Nożyce do cięcia blachy
- RUS Ножницы по металлу
- CZ Nůžky na plech
- H Lemezvágó olló
- RO Foarfece pt. tablă
- F Cisaille à tôle

- I Cesioie per lamiera
- E Tijeras para chapas
- CN 铁皮剪

SLIDING CARD



S55C
DROP FORGED
STEEL
STAL KUTA
NA ZIMNO

HRC 55-60

HIGH FREQUENCY
HARDENING
HARTOWANIE
IMPULSOWE



YATO	L (mm)	cutting length (mm)	cutting capacities (mm)				6/36
			copper	cold-rolled steel	hard steel HRC35	stainless steel 304	
YT-1963	200	40	1.5	1.0	0.6	0.6	6/36
YT-1964	250	60	1.8	1.2	0.8	0.8	6/24
YT-1965	300	75	2.0	1.4	0.8	0.8	6/12

GB Metal sheet nibbler
D Blechnibbler
PL Nożyce matrycowe do blachy
RUS Ножницы для резки жести
CZ Nůžky na plech
H Lemezvágó olló

RO Foarfece pt. tablă
F Grignoteuse a tole
I Cesoia roditrice per lamiera
E Tijeras para chapas
CN 法式剪



HALF
DOUBLE
BLISTER



GB Spare blades for metal sheet nibbler
D Abbrechklengen für Blechnibbler
PL Ostrza zapasowe do nożyc matrycowych
RUS Лезвия для ножиц для резки жести
CZ Ostrí náhradní
H Tartalékpenge

RO Lame de rezervă
F Lame sécables pour grignoteuse a tole
I Lame di ricambio per cesoia roditrice per lamiera
E Cuchillas de recambio
CN 法式剪备用刀片



for / dla:
YT-19260

YATO	L (mm)	
YT-19260	260	6/36

YATO	L (mm)	
YT-19261		10/100

GB Portable notchers
D Schere zum Ausschneiden von Ecken
PL Nożyce do wycinania naroży
RUS Ножницы для наружных углов
CZ Nůžky na vystřihování rohů
H Sarokkivágó olló
RO Foarfece pt. taierea colturilor
F Ciseaux pour le coupage des coins
I Cesoie per taglio reggetta in angoli
E Tijera para esquinas
CN 截角器

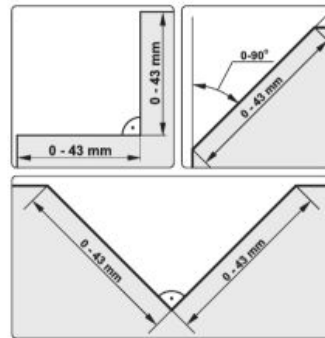

YATO	L (mm)	
YT-1939	300	15

GB Hand notchers
D Kerbzange
PL Nożyce dekarские do nacinania blach
RUS Ножницы v-образные
CZ Nůžky na plech vystřihování rohů
H Lemezvágó olló

RO Foarfece tabla taiere colturi
F Ciseaux à tôle
I Cesoie per lamiera

E Cizallas para techos
CN 缺口钳



YATO	L (mm)	
YT-18970	230	6/36

GB Nail hole slot punch
D Langlochzange
PL Szczypce do sidingu do podłużnych otworów montażowych
RUS Клещи для пробивки продольных отверстий
CZ Klempířské kleště prostřihovací - oválné otvory

H Lyukasztó fogó vágó
RO Clește pt. perforare - găuri ovale
F Pince à poinçonner en oblong
I Pinze per pannelli profilati per fori di montaggio oblunghi

E Canteadeira conjugada com furador ovoidé
CN 腰型打孔钳



YATO	L (mm)	
YT-18975	240	6/36

GB Snap lock punch
D Schnappverschluss-Lochtreiber
PL Zaciskacz punktowy
RUS Плоскогубцы для кровельщиков
CZ Střešní kleště

H Tetőfedő fogó
RO Clește pt. despiciat
F Pincés pour couvreurs

I Pinza a crimpare
E Punzón de cerradura de resorte
CN 记号钳



YATO	L (mm)	
YT-18977	230	6/36

GB Steel strap cutter
D Stahlgurtblechscherer
PL Nożyce do cięcia taśmy stalowej
RUS Ножницы для резки стальной ленты
CZ Nůžky na plech
H Lemezvágó olló
RO Foarfece pt. tablă

F Cisaile à bande acier
I Cesoia per taglio reggetta in acciaio
E Tijeras para bandejas de acero
CN 钢带剪

SLIDING CARD

HRC 58-61

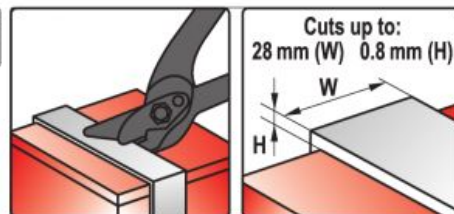

YATO	L (mm)	cutting length (mm)	cutting capacities (mm)				6/24
			copper	cold-rolled steel	hard steel HRC35	stainless steel 304	
YT-1930	305	28	-	1.00	0.80	0.60	

GB Bolt cutter
D Drahtschere
PL Nożyce do prętów
RUS Болторез
CZ Nůžky na tyče

H Kábelvágó olló
RO Foarfece pt. bare
F Cisaile pour barres
I Cesoie taglia bulloni
E Cortavarillas
CN 断线钳

HRC 56-61 CrMo



YATO	size / rozmiar	max. Ø (mm)		6
		soft / miękki	medium / średnio twardy	
YT-1843	12" (300 mm)	5	4	20
YT-1844	14" (350 mm)	7	5	10
YT-1845	18" (450 mm)	8	6	10
YT-1846	24" (600 mm)	10	8	6
YT-1847	30" (750 mm)	13	10	4
YT-1848	36" (900 mm)	16	12	3

GB Bolt cutter
D Drahtschere
PL Nożyce do prętów
RUS Болторез

CZ Nůžky na tyče
H Kábelvágó olló
RO Foarfece pt. bare
F Cisaile pour barres
I Cesoie taglia bulloni
E Cortavarillas
CN 断线钳

CrMo



YATO	size / rozmiar	max. Ø (mm)	6
YT-1851	14" (350 mm)	6	6/24
YT-1852	18" (450 mm)	7	6/12
YT-1853	24" (600 mm)	10	2/12
YT-1854	30" (750 mm)	12	6
YT-1855	36" (900 mm)	14	4
YT-1856	42" (1050 mm)	16	2

GB Concrete mesh cutter
D Mattenscheider
PL Nożyce do siatki zbrojarskiej
RUS Ножницы для резки арматурной сетки

CZ Pákové kleště na pletivo
H Gyékényvágó
RO Cleste pt. fier beton
F Coupe-treillis
I Cesoie per reti di rinforzo
E Cortante para varillas de encofrado
CN 鹰嘴断线钳

800 mm max Ø (mm) 11 CrV



YATO	L (mm)	5
YT-18400	800	

GB Hydraulic cutter
D Manueller Hydraulikschneider
PL Ręczny obcinak hydrauliczny

RUS Ручной гидравлический резак
CZ Rucni hydraulický odrezávac
H Kézi hidraulikus betonacélvágó
RO Cuti pt. retezat tevi
F Coupe manuelle hydraulique
I Cesoia idraulica manuale

E Cortadora hidráulica manual
CN 液压剪

BMC & COLOR SLEEVE

STEEL



YATO	cutting diameter / średnica cięcia (mm²)	L (mm)	pressure / nacisk (T)	5
YT-22870	4-12	320	6	

YATO	cutting diameter / średnica cięcia (mm²)	L (mm)	pressure / nacisk (T)	5
YT-22871	4-16	430	8	
YT-22872	4-20	515	13	3

GB Heads for hydraulic cutter
D Austauschmesser für Hydraulikschneider
PL Noże wymienne do obcinaka hydraulicznego
RUS Сменные ножи для гидравлического резака

CZ Vyměnitelné nože do hydraulického odrezávače
H Cserekes a hidraulikus betonacélvágóhoz
RO Lame schimbabile pt. cuti pt. retezat tevi
F Lame pour coupe manuelle hydraulique

I Teste per coltelli idraulici
E Cuchillas intercambiables para cortadora hidráulica
CN 液压钳钳口配件

SLIDING CARD



2 PCS



YATO	for / dla	size / rozmiar (mm)	10/100
YT-22873	YT-22870	12	
YT-22874	YT-22871	16	
YT-22875	YT-22872	20	

GB Ratchet cable cutter
D Ratschenkabelschneider
PL Nożyce zapadkowe do kabli
RUS Кабелерез секторный

CZ Kleště na kabely, rohatka se západkou
H Racsnis kábelvágó
RO Cleste pt. taiat cablu cu clichet

F Cisailles à câbles
I Cricchetto taglia cavo
E Cortacables de carraca
CN 棘轮电缆剪

COLOR BOX



Cu/Al
CABLE
KABEL

60S12Mn

HRC 50
CUTTING BLADE
OSTRZE THNACE



YATO	cutting range / max. przekrój cięcia (mm ²)	max. Ø (mm)	L (mm)	☐
YT-18600	240	17.5	300	10

YATO	cutting range / max. przekrój cięcia (mm ²)	max. Ø (mm)	L (mm)	☐
YT-18602	380	22	380	10

GB Cable cutter
D Kabelschere
PL Nożyce do kabli
RUS Кабелерезы
CZ Elektrické upichováky
H Kábelvágó
RO Patent tăietor pt. electrice
F Cisailles à câbles
I Cesioie per cavi
E Tijeras para cables
CN 电缆剪



STEEL
STAL

COLOR BOX



YATO	cutting range / max. przekrój cięcia (mm ²)	max. Ø (mm)	L (mm)	☐
YT-18610	125	12.5	370	20
YT-18611	250	18.0	580	10
YT-18612	500	25.0	770	5

GB Multi function scissors
D Multifunktionsmesser
PL Nożyce wielofunkcyjne
RUS Ножницы многофункциональные
CZ Víceúčelové nůžky
H Többfunkciós olló
RO Foarfece multifuncționale
F Cisailles universelle
I Cesioie multifunzione
E Tijeras multifuncionales
CN 多用剪



SLIDING
CARD



65
mm

3Cr13
STAINLESS
STEEL
NIERZĄDZEWNA

HRC
50-54

YATO	L (mm)	☐
YT-1976	65	12/72

GB Hand saw for wood
D Handsäge
PL Piła płatkowa do drewna
RUS Пила по дереву
CZ Pila na dřevo platnice
H Fafűrész, egyenes

RO Ferăstrău pt. lemn
F Scie
I Seghetto per legno
E Serrucho para madera
CN 手板锯

COLOR SLEEVE



Mn
65

7T
inch

1.6 mm
0.9 mm

HRC
50-54



YATO	L (mm)	☐
YT-3101	400	12/48
YT-3102	450	10/40
YT-3103	500	10/40



PTFE
COATED
POWŁOKA

YATO	L (mm)	☐
YT-3106	400	12/48
YT-3107	450	10/40
YT-3108	500	10/40

GB Back saw for PVC
D Handsäge für PVC
PL Piła ręczna do PCV
RUS Ручная пила для ПВХ
CZ Ruční pila na PVC

H Kézifűrész PVC-hez
RO Fierăstrău cu maner PVC
F Scie à main pour PVC
I Segha a mano per PVC

E Sierra de mano para PVC
CN PVC鋸

440
mm

350mm

17
TPI

65
Mn

PVC

COLOR SLEEVE



YATO	L (mm)	☐
YT-31303	440	12/48

- GB Japanese saw
- D Japanische Handsäge
- PL Pila japońska
- RUS Ножовка японского типа
- CZ Japonská ruka pila
- H Japán fűrész
- RO Fierastrau japonez
- F Scie japonaise
- I Sega reversibile giapponese
- E Sierra japonesa
- CN 双面齿拉锯



YATO **YT-31310**

660 mm 320mm 7 TPI 12 TPI SK5

COLOR SLEEVE

YATO	L (mm)	
YT-31310	660	10/40

- GB Drywall saw
- D Gipskartonsäge
- PL Pila dwustronna do płyt gipsowo-kartonowych
- RUS Ножовка по гипсокартону
- CZ Pilka na sádrokarton
- H Gipskarton fűrész
- RO Kézi gipskarton fűrész
- F Scie à guichet
- I Sega per pannelli in cartongesso
- E Serrucho para placas de yeso
- CN 墙板锯



YATO **YT-31343**

315 mm 180mm 7 TPI 7 TPI 65 Mn

COLOR SLEEVE

YATO	L (mm)	
YT-31343	315	12/96

- GB Back saw
- D Rückssäge
- PL Pila grzbietnica
- RUS Пила для стула
- CZ Pila hřebenovka
- H Kézifűrész
- RO Ferăstrău coadă de vulpe
- F Scie
- I Sega con dorso
- E Serrucho de costilla
- CN 夹背锯

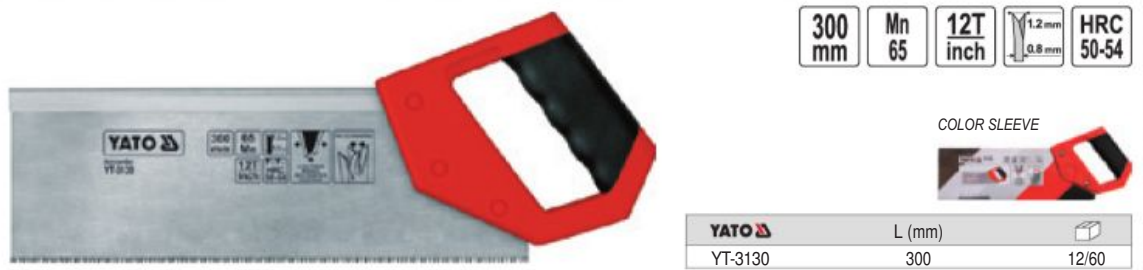

YATO **YT-3130**

300 mm Mn 65 12T inch 1.2mm 0.8mm HRC 50-54

COLOR SLEEVE

YATO	L (mm)	
YT-3130	300	12/60

- GB Compass saw
- D Stichsäge
- PL Pila otwornica
- RUS Выкружная пила
- CZ Pila otwornice
- H Lyukfűrész
- RO Ferăstrău coadă de șoarece
- F Scie étroite
- I Sega a foretto
- E Serrucho de punta
- CN 鸡尾锯



YATO **YT-3133**

300 mm Mn 65 7T inch 1.6mm 0.9mm HRC 50-54

COLOR SLEEVE

YATO	L (mm)	
YT-3133	300	12/60

- GB Wallboard saw
- D Gipsssäge
- PL Pila do gipsów
- RUS Ножовка по гипсокартону
- CZ Pila na sádru
- H Gipszfűrész
- RO Ferăstrău pt. ghips
- F Scie pour plaques de plâtre
- I Sega per cartongesso
- E Serrucho para cartón yeso
- CN 墙板锯



YATO **YT-3134**

300 mm Mn 65 7T inch 1.6mm 1.5mm HRC 50-54

COLOR SLEEVE

NO CLOGGING BEZ ZAKLESZCZANIA

3 CUTTING EDGES 60% FASTER CUTTING
3 KRAWĘDZIE TNACE O 60% SZYBSZE CIĘCIE

YATO	L (mm)	
YT-3134	150	12/60

- GB Plastic miter box with dovetail saw
- D Kunststoffschneidladen mit Säge
- PL Plastikowa skrzynka uciosowa z piłą
- RUS Стуло пластмассовое с пилой
- CZ Přípravek na fezáni úhlu s pilkou
- H Gэрбевágo műanyagláda hód farkú fűrészszel
- RO Fierastrau cu dispozitiv de taiat la unghi
- F Boîte à onglets + scie
- I Taglia cornici in plastica con sega
- E Guía de ingletar y sierra
- CN 燕尾锯



YATO **YT-3150**

350 mm Mn 65 HRC 50-54 1.2mm 0.8mm 12T inch ABS 300x140 x70mm

COLOR BOX

YATO	L (mm)	
YT-3150	350	10

- GB Bow saw
- D Bügelsäge
- PL Pila kabłąkowa
- RUS Лучковая пила
- CZ Oblouková pila
- H Keretes fűrész
- RO Ferăstrău de curbură
- F Scie à bûches
- I Sega ad arco
- E Sierra de arco
- CN 两用弓锯



YATO

WOOD DREWNÓ

YATO	L (mm)	
YT-3201	450	12/24
YT-3202	530	
YT-3203	610	
YT-3204	760	



YATO	L (mm)	
YT-3200	300	12/24

- GB Blade for dry wood
D Trockenholzsägeblatt für Handsäge
PL Brzeczczot do drewna suchego
RUS Лезвие для работы по сухому дереву
CZ Pilový list na suché dřevo
- H Fűrészlap száraz fához
RO Lama pt. lemn uscat
F lame à bois sec
I Lama per il legno secco
E Hoja de sierra para madera seca
CN 干木锯条

HCS
65



- GB Blade for wet wood
D Nassholzsägeblatt für Handsäge
PL Brzeczczot do drewna mokrego
RUS Лезвие для работы по влажному дереву
CZ Pilový list na mokré dřevo
- H Fűrészlap nedves fához
RO Lama pt. lemn verde
F lame à bois humide
I Lama per il legno bagnato
E Hoja de sierra para madera mojada
CN 湿木锯条

HCS
65



COLOR SLEEVE

COLOR SLEEVE

YATO	L (mm)	
YT-3221	450	50/200
YT-3222	530	
YT-3223	610	
YT-3224	760	

YATO	L (mm)	
YT-3230	300	50/200
YT-3231	450	
YT-3232	530	
YT-3233	610	
YT-3234	760	

- GB Hacksaw frame
D Metallbogensäge
PL Piła do metalu
- RUS Пила по металлу
CZ Pilka na železo
H Fémfűrész
- RO Ferăstrău cu cadru metalic
F Scie à métal
- I Seghetto per metallo
E Sierra de metalo
CN 锯架

COLOR SLEEVE



BI-METAL

24
TPI



YATO	L (mm)	
YT-3160	300	10



YATO	L (mm)	
YT-3161	300	6/36



YATO	L (mm)	
YT-3163	300	5/20

- GB Hacksaw frame blade
D Metallsägeblatt
PL Brzeczczot do metalu
- RUS Полотно по металлу
CZ Pilový list na kovy
H Fémfűrész lap
- RO Panza fierastrau pt. metal
F lame à métal
I Lama per metallo
- E Hoja de sierra para metalo
CN 锯条

300
mm

12
mm

24
TPI



BI-METAL
M2+6150

BI-METAL
M2+Co8%

YATO	L (mm)	W (mm)	TPI	PCS packing	
YT-3460	300	12	24	5	10/200

YATO	L (mm)	W (mm)	TPI	PCS packing	
YT-3461	300	12	24	2	20/500

YATO	L (mm)	W (mm)	TPI	PCS packing	
YT-3462	300	12	24	2	20/500

- GB Jig saw blades
D Stichsägeblätter
PL Brzeczczoty do wyrzynarki
RUS Полотно для станка
CZ Pilový list do přímočaré pily
H Dekopírlap

- RO Lama fierastrau pendular
F lame pour scie sauteuse
I lame per seghetti pneumatici
E Recambio sierra de calar
CN 锯片



SLIDING
CARD



5
PCS

for / dla: YT-09955

YATO	TPI	
YT-09958	24	50/200
YT-09959	32	50/200

- GB Sabre saw blade
D Säbelsägeblatt
PL Brzeczczot do cegieł i pustaków
RUS Пильное полотно
CZ Pilový plátek do pily ocasky
H Szablyafűrészlap
RO Pânză de ferăstrău sabie
F Lames scie sabre
I Lama per mattoni e mattoni cavi
E Hoja de sierra sable
CN 硬质合金锯条

ROUGH



455
mm

2TPI



HM



YATO	L (mm)	
YT-33950	455	25/100

GB Jig saw blades
 D Stichsägeblätter
 PL Brzeczoty do wyrzynarki
 RUS Полотно для электр. станка
 CZ Pílový list do přímočaré pily
 H Dekopírlap
 RO Lama fierastru pendular
 F Lames à scie sauteuse
 I Scalpelli per il seghetto
 E Recambio sierra de calar
 CN 曲线锯条



YT-3401 YATO HCS WOOD



YATO	L (mm)	working length / długość robocza (mm)	thickness / grubość (mm)	TPI	
YT-3401	100	75	1.3	10	50/250

YT-3402 YATO HCS WOOD



YATO	L (mm)	working length / długość robocza (mm)	thickness / grubość (mm)	TPI	
YT-3402	100	75	1.2	8	50/250

YT-3403 YATO HCS WOOD



YATO	L (mm)	working length / długość robocza (mm)	thickness / grubość (mm)	TPI	
YT-3403	100	75	1.3	6	50/250

YT-3404 YATO HCS WOOD



YATO	L (mm)	working length / długość robocza (mm)	thickness / grubość (mm)	TPI	
YT-3404	100	75	1.3	10	50/250

YT-3405 YATO HCS WOOD



YATO	L (mm)	working length / długość robocza (mm)	thickness / grubość (mm)	TPI	
YT-3405	100	75	1.3	6	50/250

YT-3407 YATO HCS WOOD



YATO	L (mm)	working length / długość robocza (mm)	thickness / grubość (mm)	TPI	
YT-3407	75	50	1.0	13	50/250

YT-3408 YATO HCS WOOD



YATO	L (mm)	working length / długość robocza (mm)	thickness / grubość (mm)	TPI	
YT-3408	115	90	1.3	13-8	50/250

YT-3409 YATO HCS WOOD



YATO	L (mm)	working length / długość robocza (mm)	thickness / grubość (mm)	TPI	
YT-3409	115	90	1.3	8	50/250

YT-3410 YATO HCS WOOD



YATO	L (mm)	working length / długość robocza (mm)	thickness / grubość (mm)	TPI	
YT-3410	100	75	1.4	6	50/250

YT-3411 YATO HSS METAL



YATO	L (mm)	working length / długość robocza (mm)	thickness / grubość (mm)	TPI	
YT-3411	100	75	1.0	8	25/250

YT-3412 YATO HSS METAL



YATO	L (mm)	working length / długość robocza (mm)	thickness / grubość (mm)	TPI	
YT-3412	75	50	1.0	21	25/250

YT-3413 YATO HSS METAL



YATO	L (mm)	working length / długość robocza (mm)	thickness / grubość (mm)	TPI	
YT-3413	75	50	1.0	12	25/250

YT-3414 YATO HSS METAL



YATO	L (mm)	working length / długość robocza (mm)	thickness / grubość (mm)	TPI	
YT-3414	75	50	1.0	32	25/250

YT-3415 YATO HSS METAL



YATO	L (mm)	working length / długość robocza (mm)	thickness / grubość (mm)	TPI	
YT-3415	100	75	1.0	24-10	25/250

YT-3416 YATO HSS METAL

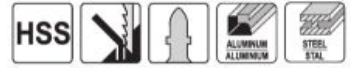

YATO	L (mm)	working length / długość robocza (mm)	thickness / grubość (mm)	TPI	
YT-3416	130	106	1.0	21	25/250

YT-3417 YATO BI-METAL UNIVERSAL



YATO	L (mm)	working length / długość robocza (mm)	thickness / grubość (mm)	TPI	
YT-3417	130	106	1.27	10-5	25/250

YT-3421 YATO HM(TC) CERAMIC



YATO	L (mm)	working length / długość robocza (mm)	thickness / grubość (mm)	TPI	
YT-3421	75	50	1.2	-	25/250

YT-3434 YATO HCS WOOD

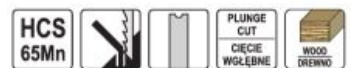

YATO	L (mm)	working length / długość robocza (mm)	thickness / grubość (mm)	TPI	
YT-3434	108	91	1.3	12-8	25/250

YT-3435 YATO BI-METAL WOOD

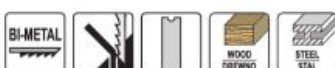

YATO	L (mm)	working length / długość robocza (mm)	thickness / grubość (mm)	TPI	
YT-3435	100	83	1.27	6	25/250

YT-3440 YATO HSS METAL



YATO	L (mm)	working length / długość robocza (mm)	thickness / grubość (mm)	TPI	
YT-3440	70	53	1.0	21	25/250

YT-3441 YATO HSS METAL



YATO	L (mm)	working length / długość robocza (mm)	thickness / grubość (mm)	TPI	
YT-3441	70	53	1.0	12	25/250

YT-3442 YATO HSS METAL



YATO	L (mm)	working length / długość robocza (mm)	thickness / grubość (mm)	TPI	
YT-3442	70	53	1.0	36	25/250

YT-3443 YATO HSS METAL



YATO	L (mm)	working length / długość robocza (mm)	thickness / grubość (mm)	TPI	
YT-3443	91.5	74.5	1.0	21-16	25/250

YT-3444 YATO BI-METAL UNIVERSAL



YATO	L (mm)	working length / długość robocza (mm)	thickness / grubość (mm)	TPI	
YT-3444	127	110	1.2	10-5	25/250

YT-3424 YATO HCS WOOD



YATO	L (mm)	working length / długość robocza (mm)	thickness / grubość (mm)	TPI	
YT-3424	100	75	1.3	10	

YT-3433 YATO HCS WOOD



YATO	L (mm)	working length / długość robocza (mm)	thickness / grubość (mm)	TPI	
YT-3433	100	75	1.3	6	

YT-3445 YATO BI-METAL WOOD



YATO	L (mm)	working length / długość robocza (mm)	thickness / grubość (mm)	TPI	
YT-3445	100	75	1.3	10	25/250
	100	75	1.3	6	
	100	75	1.27	10	
	75	50	1.0	32	
	75	57	1.0	12	

GB Half-moon saw blade for oscillating multitool HSS
 D Rundes Sägeblatt HSS für ein Multifunktionswerkzeug
 PL Brzeszczot okrągły HSS do narzędzia wielofunkcyjnego
 RUS Дисковое полотно HSS для многофункционального инструмента
 CZ Segmentový pilový list HSS pro multifunkční nářadí
 H HSS kör keresztmetszetű fűrészlap multifunkciós szerszámhoz
 RO Lamă rotundă HSS pt. unealta multifuncțională
 F lame segment HSS pour outil multifonction
 I Lama di sega circolare per lo strumento multi-funzione HSS
 E Hoja redonda HSS para herramienta multifuncional
 CN 高速钢半圆形锯片



88 mm

HSS

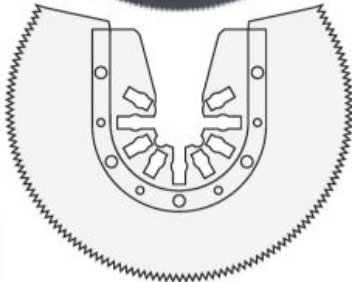

- application: wood, plastic, soft metal, plaster
- zastosowanie: drewno, plastik, miękki metal, gips



CUTTING / CIĘCIE

for / dla: YT-82220, YT-82223, YT-82818, YT-82900

YATO YT-34680 5/100

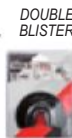

GB Half-moon saw blade for oscillating multitool HCS
 D Rundes Sägeblatt HCS für ein Multifunktionswerkzeug
 PL Brzeszczot okrągły HCS do narzędzia wielofunkcyjnego
 RUS Дисковое полотно HCS для многофункционального инструмента
 CZ Segmentový pilový list HCS pro multifunkční nářadí
 H HCS kör keresztmetszetű fűrészlap multifunkciós szerszámhoz
 RO Lamă rotundă HCS pt. unealta multifuncțională
 F lame segment HCS pour outil multifonction
 I Lama di sega circolare per lo strumento multi-funzione HCS
 E Hoja redonda HCS para herramienta multifuncional
 CN 高碳钢扇形锯片



88 mm

HCS

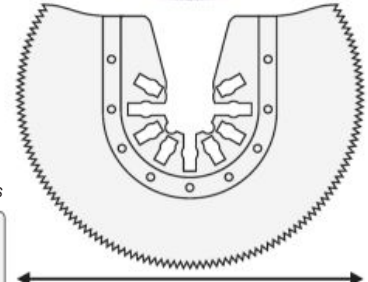

- application: wood, plastic, soft metal, plaster
- zastosowanie: drewno, plastik, miękki metal, gips

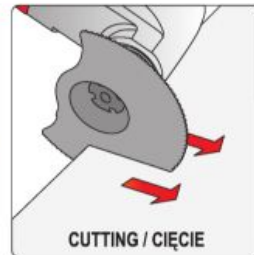

CUTTING / CIĘCIE

for / dla: YT-82220, YT-82223, YT-82818, YT-82900

YATO YT-34681 5/100

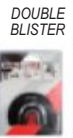

GB Brazed carbide d-shape blade for oscillating multitool HM
 D Rundes Sägeblatt HM für ein Multifunktionswerkzeug
 PL Brzeszczot okrągły HM do narzędzia wielofunkcyjnego
 RUS Дисковое полотно HM для многофункционального инструмента
 CZ Segmentový pilový list HM pro multifunkční nářadí
 H HM kör keresztmetszetű fűrészlap multifunkciós szerszámhoz
 RO Lamă rotundă HM pt. unealta multifuncțională
 F lame segment HM pour outil multifonction
 I Lama di sega circolare per lo strumento multi-funzione HM
 E Hoja redonda HM para herramienta multifuncional
 CN D形合金磨片



70 mm

HM

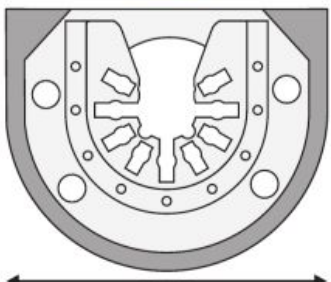
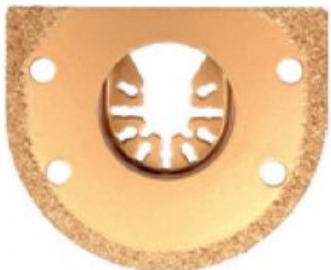

- application: concrete, ceramic materials, epoxy resin, fiberglass
- zastosowanie: beton, materiały ceramiczne, żywica epoksydowa, włókno szklane

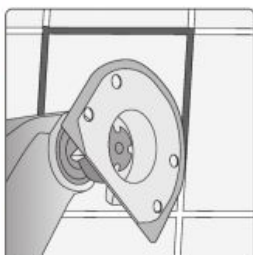

for / dla: YT-82220, YT-82223, YT-82818, YT-82900

YATO YT-34682 10/100



GB Plunge cutting saw blade for oscillating multitool BIM
 D Tiefenmesser BIM für ein Multifunktionswerkzeug
 PL Brzeszczot węgłny BIM do narzędzia wielofunkcyjnego
 RUS Сабельное полотно BIM для многофункционального инструмента
 CZ Pilový list BIM na ponorné řezy pro multifunkční nářadí
 H BIM merülő fűrészlap multifunkciós szerszámhoz
 RO Lamă de adâncime BIM pt. unealta multifuncțională
 F lame scie plongeante BIM pour outil multifonction
 I Lama per tagli dal pieno BIM
 E Hoja para cortes profundos BIM para herramienta multifuncional
 CN 双金属直锯片



10 mm

BIM

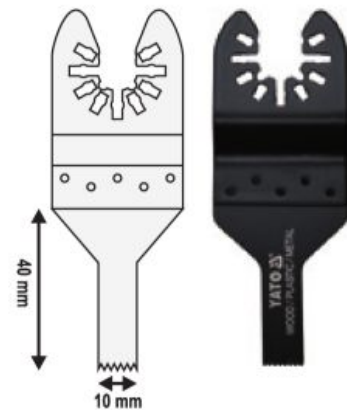

- application: wood, plastic, metal, plaster, epoxy resin
- zastosowanie: drewno, plastik, metal, gips, żywica epoksydowa



CUTTING / CIĘCIE

for / dla: YT-82220, YT-82223, YT-82818, YT-82900

YATO YT-34683 5/100



GB Plunge cutting saw blade for oscillating multitool BIM
 D Tiefenmesser BIM für ein Multifunktionswerkzeug
 PL Brzeczscot węglbny BIM do narzędzia wielofunkcyjnego
 RUS Сабельное полотно BIM для многофункционального инструмента
 CZ Pilový list BIM na ponorné řezy pro multifunkční nářadí
 H BIM merülő fűrészlap multifunkciós szerszámhoz
 RO Lamă de adâncime BIM pt. unealta multifuncțională
 F Lame scie plongeante BIM pour outil multifonction
 I Lama per tagli dal pieno BIM
 E Hoja para cortes profundos BIM para herramienta multifuncional
 CN 双金属直锯片



3
PCS
28.5
mm
BIM

- application: wood, plastic, metal, plaster, epoxy resin
- zastosowanie: drewno, plastik, metal, gips, żywica epoksydowa

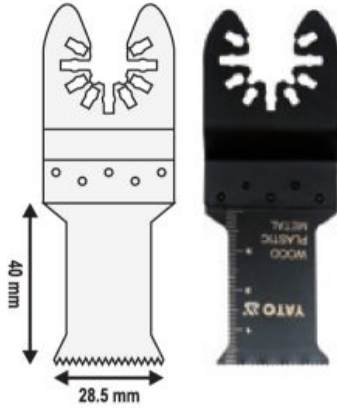

CUTTING / CIĘCIE

for / dla: YT-82220, YT-82223,
YT-82818, YT-82900

YATO
YT-34684

DOUBLE
BLISTER



5/100

GB Plunge cutting saw blade for oscillating multitool HCS
 D Tiefenmesser HCS für ein Multifunktionswerkzeug
 PL Brzeczscot węglbny HCS do narzędzia wielofunkcyjnego
 RUS Сабельное полотно HCS для многофункционального инструмента
 CZ Pilový list HCS na ponorné řezy pro multifunkční nářadí
 H HCS merülő fűrészlap multifunkciós szerszámhoz
 RO Lamă de adâncime HCS pt. unealta multifuncțională
 F Lame scie plongeante HCS pour outil multifonction
 I Lama per tagli dal pieno HCS
 E Hoja para cortes profundos HCS para herramienta multifuncional
 CN 高碳钢直锯片



3
PCS
34
mm
HCS

- application: wood, plastic, plaster
- zastosowanie: drewno, plastik, gips

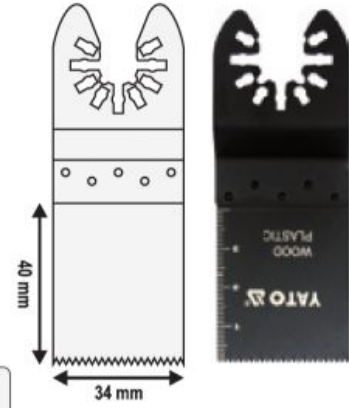

CUTTING / CIĘCIE

for / dla: YT-82220, YT-82223,
YT-82818, YT-82900

YATO
YT-34685

DOUBLE
BLISTER



5/100

GB Plunge cutting saw blade for oscillating multitool BIM
 D Tiefenmesser BIM für ein Multifunktionswerkzeug
 PL Brzeczscot węglbny BIM do narzędzia wielofunkcyjnego
 RUS Сабельное полотно BIM для многофункционального инструмента
 CZ Pilový list BIM na ponorné řezy pro multifunkční nářadí
 H BIM merülő fűrészlap multifunkciós szerszámhoz
 RO Lamă de adâncime BIM pt. unealta multifuncțională
 F Lame scie plongeante BIM pour outil multifonction
 I Lama per tagli dal pieno BIM
 E Hoja para cortes profundos BIM para herramienta multifuncional
 CN 双金属直锯片



20
mm
BIM

- application: wood, plastic, metal, plaster, epoxy resin
- zastosowanie: drewno, plastik, metal, gips, żywica epoksydowa

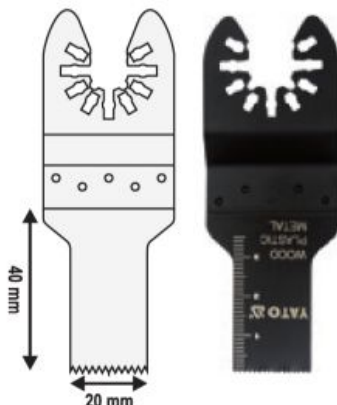

CUTTING / CIĘCIE

for / dla: YT-82220, YT-82223,
YT-82818, YT-82900

YATO
YT-34686

DOUBLE
BLISTER



5/100

GB Brazed carbide triangular rasp for oscillating multitool
 D Dreieckige Raspel für ein Multifunktionswerkzeug
 PL Tarnik trójkątny do narzędzia wielofunkcyjnego
 RUS Треугольный рашпиль для многофункционального инструмента
 CZ Trojúhelníková brusná deska pro multifunkční nářadí
 H Háromszög keresztmetszetű reszelő multifunkciós szerszámhoz
 RO Rășpel triunghiular pt. unealta multifuncțională
 F Plateau de ponçage à concretion carbure pour outil multifonction
 I Raspa in metallo duro forma triangolare multi-funzione
 E Escofina triangular para herramienta multifuncional
 CN 三角形嵌合金磨片



80
mm
HM

- application: concrete, ceramic materials
- zastosowanie: beton, materiały ceramiczne

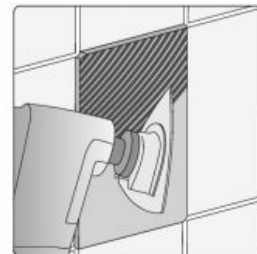
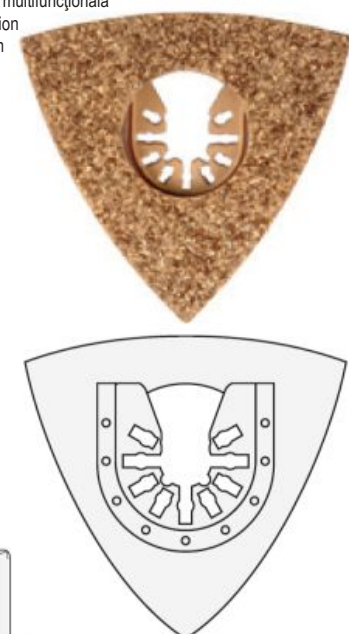

CUTTING / CIĘCIE

for / dla: YT-82220, YT-82223,
YT-82818, YT-82900

YATO
YT-34687

DOUBLE
BLISTER



5/100

GB Short scraper for oscillating multitool
D Schaber für ein Multifunktionswerkzeug
PL Skrobak do narzędzia wielofunkcyjnego
RUS Скребок для многофункционального инструмента
CZ Škrabka pro multifunkční nářadí
H Kaparó multifunkciós szerszámhoz
RO Răzuitor pt. unealta multifuncțională
F Spatule pour outil multifonction
I Raschietto oscillante multifunzione adatto
E Raspador para herramienta multifuncional
CN 弯刮刀



52 mm
HCS



52 mm

• application:
paint, adhesives,
sealing compounds

• zastosowanie:
farby, kleje, masy uszczelniające



SCRAPING
ZDRAPYWANIE

DOUBLE
BLISTER

for / dla: YT-82220, YT-82223,
YT-82818, YT-82900

YATO
YT-34688

5/100

GB Triangular eva sanding pad for oscillating multitool
D Schleiffuß für ein Multifunktionswerkzeug
PL Stopa szlifierska do narzędzia wielofunkcyjnego
RUS Шлифовальная насадка для многофункционального инструмента
CZ Brusný nástavec pro multifunkční nářadí
H Csiszoló talp multifunkciós szerszámhoz
RO Picior de sablare pt. unealta multifuncțională
F Plateau de ponçage pour outil multifonction
I Tasso di smerigliatrice multifunzionale
E Pie de rectificación para herramienta multifuncional
CN 三角砂盘



90 mm
EVA



90 mm

• application:
wood, metal, plaster

• zastosowanie:
drewno, metal, gips



SANDING / SZLIFOWANIE

DOUBLE
BLISTER

for / dla: YT-82220, YT-82223,
YT-82818, YT-82900

YATO
YT-34689

5/100

GB Triangular sand paper for oscillating multitool
D Schleifpapier für ein Multifunktionswerkzeug
PL Papier ścierny do narzędzia wielofunkcyjnego
RUS Шлифовальная бумага для многофункционального инструмента
CZ Brusné plátno pro multifunkční nářadí
H Csiszolópapír multifunkciós szerszámhoz
RO Hârtie abrazivă pt. unealta multifuncțională
F Feuilles abrasives pour outil multifonction
I Carta abrasiva per utensile multifunzione
E Papel de lija para herramienta multifuncional
CN 三角砂纸



10 mm



90 mm

• application:
wood, metal, plaster

• zastosowanie:
drewno, metal, gips



SANDING / SZLIFOWANIE

DOUBLE
BLISTER

for / dla: YT-82220, YT-82223,
YT-82818, YT-82900

YATO
YT-34690

5/100

GB Accessories set for oscillating multitool
D Zubehörsatz für ein Multifunktionswerkzeug
PL Zestaw akcesoriów do narzędzia wielofunkcyjnego
RUS Набор принадлежностей для многофункционального инструмента
CZ Souprava příslušenství pro multifunkční nářadí
H Tartozék szett multifunkciós szerszámhoz
RO Set de accesorii pt. unealta multifuncțională
F Set d'accessoires pour outil multifonction
I Set di accessori per utensile multifunzione
E Juego de accesorios para herramienta multifuncional
CN 三件套：双金属直锯片 + 高碳钢直锯片 + 高速钢半圆形锯片



3 PCS
HSS
HCS
BIM

• application:
wood, plastic,
metal, plaster,
epoxy resin

• zastosowanie:
drewno, plastik,
metal, gips,
żywica epoksydowa



CUTTING / CIĘCIE



CUTTING / CIĘCIE

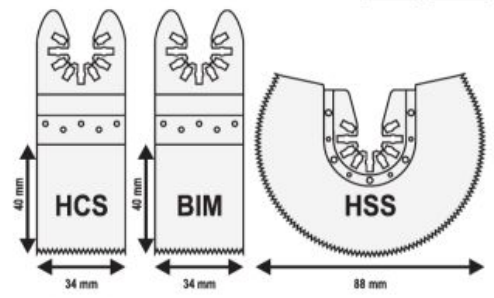

40 mm

HCS

40 mm

BIM

88 mm

HSS

34 mm

34 mm

88 mm

for / dla: YT-82220, YT-82223,
YT-82818, YT-82900

YATO
YT-34691

DOUBLE
BLISTER

5/100

GB Tube wire brush
 D Zylinder-Drahtbürste
 PL Szczotka drucziana cylindryczna
 RUS Щетка-ерш для чистки трубок
 CZ Kartáč na trubky

H Tisztító belső kefe
 RO Perie sarma de curatat tevi
 F Brosse cylindrique pour tubes en fil d'acier ondulé

I Spazzola metallica a cilindro
 E Cepillos en espiral para tubos
 CN 试管刷

SLIDING CARD



YATO	size / rozmiar (mm)	
YT-47695	20x65x200	10/80
YT-47696	26x65x200	10/80
YT-47697	32x65x200	10/80
YT-47698	38x65x200	10/80



GB Steel wire brush
 D Stahldrahtbürste

PL Szczotka drucziana
 RUS Щетка стальная

CZ Drátěný kartáč
 H Drótkefe

RO Perie de sârmă
 F Brosse de fil en laiton

I Spazzola metallica
 E Cepillo de acero

CN 钢丝刷



ZINC PLATED WIRES



YATO	rows / rzędy	
YT-6353	3	12/120
YT-6354	4	12/120
YT-6355	5	12/120
YT-6356	6	12/120

YATO	rows / rzędy	
YT-6358	4	12/72
YT-6359	5	12/72
YT-6360	6	12/72

GB Steel wire brush
 D Stahldrahtbürste
 PL Szczotka drucziana
 RUS Щетка стальная
 CZ Drátěný kartáč
 H Drótkefe
 RO Perie de sârmă

F Brosse de fil en laiton
 I Spazzola metallica
 E Cepillo de acero
 CN 钢丝刷

TIED ON CARD



YATO	rows / rzędy	L (mm)	
YT-6330	3	340	12/72

YATO	rows / rzędy	L (mm)	
YT-6331	3	340	12/72



STEEL STAL



STEEL STAL



STEEL STAL

YATO	rows / rzędy	L (mm)	
YT-6332	4	260	12/72

YATO	rows / rzędy	L (mm)	
YT-6333	4	290	12/72

YATO	rows / rzędy	L (mm)	
YT-6334	6	180x65	12/60



SS STAINLESS STEEL STAL NERDZIEWA



SS STAINLESS STEEL STAL NERDZIEWA



SS STAINLESS STEEL STAL NERDZIEWA

YATO	rows / rzędy	L (mm)	
YT-6335	3	340	12/72

YATO	rows / rzędy	L (mm)	
YT-6336	3	340	12/72

YATO	rows / rzędy	L (mm)	
YT-6337	3	180	24/144



SS STAINLESS STEEL STAL NERDZIEWA



SS STAINLESS STEEL STAL NERDZIEWA



SS STAINLESS STEEL STAL NERDZIEWA

YATO	rows / rzędy	L (mm)	
YT-6338	4	260	12/72

YATO	rows / rzędy	L (mm)	
YT-6339	4	290	12/72

YATO	rows / rzędy	L (mm)	
YT-6340	5	180	24/120



BRASS MOSIĄDZ



BRASS MOSIĄDZ



BRASS MOSIĄDZ

YATO	rows / rzędy	L (mm)	
YT-6341	3	340	12/72

YATO	rows / rzędy	L (mm)	
YT-6343	3	180	24/144

YATO	rows / rzędy	L (mm)	
YT-6344	4	260	12/72



BRASS MOSIĄDZ



BRASS MOSIĄDZ



NYLON

YATO	rows / rzędy	L (mm)	
YT-6345	4	290	12/72

YATO	rows / rzędy	L (mm)	
YT-6346	5	180	24/120

YATO	rows / rzędy	L (mm)	
YT-6349	5	180	24/120

GB Plastic handle wire brush set
 D Bürstensatz
 PL Komplet szczotek druczianych
 RUS Щетки - набор
 CZ Drátěný kartáče
 H Kefekészlet
 RO Perii

F Set de broches de fil en laiton
 I Set di spazzole metalliche
 E Juego de 3 cepillos
 CN 钢丝刷组套

SLIDING CARD



YATO	rows / rzędy	L (mm)	
YT-6351	3	180	24/144

- GB Wire brush set
D Bürsten Sortiment
PL Zestaw szczotek do gniazd wtryskiwaczy
RUS Ерши с наружной резьбой в наборе
CZ Rourové kartáče válcové
H Henger drótkefe
RO Perii cilindrice pt. curatarea gaurilor
F Brosse cylindrique
I Vetro di protezione
E Cepillos para limpieza interior
CN 件套清洁组

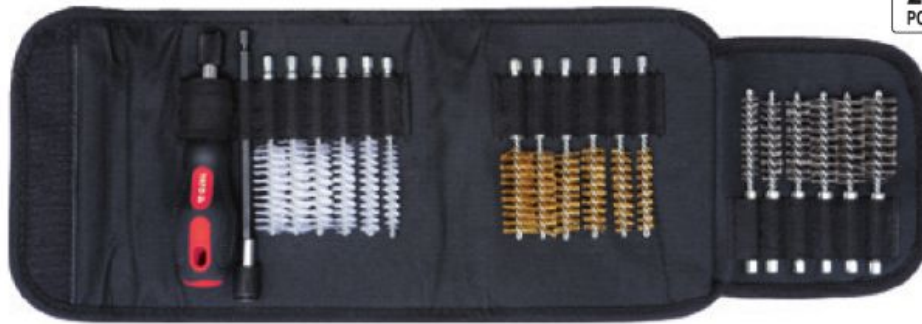

20 PCS	150 mm	1/4" 6.3mm	9,11,13 15,17,19 mm
NYLON	SS STAINLESS STEEL ĘCZ. NIEKORZYŻNA	BRASS MOSIADZ	



YATO		
YT-08195		24

- GB Copper pipe internal brush
D Kupferrohr Innenbürste
PL Szczotka wewnętrzna do rur miedzianych
RUS Щетка для внутренней очистки труб
CZ Kartáč vnitřní na měděné trubky
H Rézcső belső tisztító kefe

- RO Perii de interior pt. tevi de cupru
F Brosse aux tubes en cuivre
I Spazzola per il rame interno
E Cepillo para limpieza de tubos de cobre
CN 管子刷



- GB Copper pipe brush 2 in 1
D 2-in-1 Kupferrohrbürste für Innen- und Außenreinigung
PL Szczotka do rur miedzianych 2 w 1
RUS Щетка для внутренней и внешней зачистки медных труб
CZ Kartáč vnitřní a vnější na měděné trubky

- H Rézcső tisztító kefe 2 in 1
RO Perii pt. tevi de cupru 2 in 1
F Brosse aux tubes en cuivre
I Spazzola per il tubi di rame 2 in 1
E 2-en-1 cepillo para limpieza de tubos de cobre int. y ext
CN 2合1管子刷



SLIDING CARD



YATO	internal pipe diameter / wewnętrzna średnica rury (mm)	
YT-63701	15	12/120
YT-63702	18	12/120
YT-63703	22	12/120
YT-63704	28	12/120

YATO	external & internal pipe diameter / zewnętrzna i wewnętrzna średnica rury (mm)	
YT-63705	15; 22	50/100

- GB Cleaning pad set for copper pipes
D Reinigungsvlies-satz für Kupferrohre
PL Włóknina do czyszczenia rur miedzianych
RUS Губка абразивная
CZ Brusné rouno
H Tisztítószivacs
RO Burete abraziv
F Tampons de nettoyage
I Fibra abrasiva per la pulizia de tubo di rame
E Almojadilla abrasiva
CN 件套工业洁



COLOR SLEEVE



10 PCS	75x130 mm	FOR PIPES DO RUR Cu
METAL FREE NIE ZAWIERA METALU	DRY WORK PRACA NA SUCHO	WET WORK PRACA NA MOKRO



YATO	size / rozmiar (mm)	
YT-63740	75x130	50

- GB Cup brush with shaft
D Stahldraht-Topfbürste
PL Szczotka czolowa z trzpieniem

- RUS Щетка "чашка" со стержнем
CZ Čelní kartáč drátěný se stopkou
H Homlok drótkefe, nyéllel

- RO Perie frontală pt. bormasina
F Brosse coupe avec gouppille
I Spazzola a tazza

- E Cepillo de copa con mandril
CN 钢丝轮

SLIDING CARD



YATO	Ø (mm)	R.P.M.max.	
YT-4750	75	4500	12/96

YATO	Ø (mm)	R.P.M.max.	
YT-4751	75	4500	12/96

YATO	Ø (mm)	R.P.M.max.	
YT-4752	75	6000	12/72

- GB Cup brush with shaft set
D Drahtbürste mit Einspannschaft
PL Szczotki druciane z trzpieniem
RUS Щетки проволочные со стержнем
CZ Drátěný kartáč se stopkou
H Drótkefe, csapos
RO Perii de sârmă cu tijă
F Set de brosses coupe avec gouppille
I Spazzola metallica a disco
E Cepillos de alambre con espiga
CN 三件钢丝组套



SLIDING CARD



YATO	Ø (mm)	R.P.M.max.	
YT-4755	20	6000	12/60
	50	7500	
	50	4500	

GB Circular brush with shaft
D Stahldraht-Scheibenbürste
PL Szczotka tarczowa z trzpieniem

RUS Щетка круговая со стержнем
CZ Okružní kartáč drátěný se stopkou
H Tarcás drótkefe, nyéllel

RO Perie rotunda pt. bormasina
F Brosse circulaire avec goupille
I Spazzola a disco

E Cepillo redondo
CN 钢丝轮

SLIDING CARD



INOX
STAINLESS STEEL
ÉTEL, NIKROZEL

YATO	Ø (mm)	R.P.M.max.	Box
YT-4757	100	4500	12/96

YATO	Ø (mm)	R.P.M.max.	Box
YT-4758	100	4500	12/96

YATO	Ø (mm)	R.P.M.max.	Box
YT-4759	75	20000	10/100

GB Circular brush
D Stahldraht-Scheibenbürste
PL Szczotka tarczowa z gwintem

RUS Щетка круговая
CZ Okružní kartáč drátěný
H Tarcás drótkefe

RO Perie rotunda pt. bormasina
F Brosse circulaire avec filet
I Spazzola conica

E Cepillo redondo
CN 钢丝轮

COLOR BOX



M14



INOX
STAINLESS STEEL
ÉTEL, NIKROZEL

YATO	Ø (mm)	R.P.M.max.	Box
YT-4761	100	12500	8/64

YATO	Ø (mm)	R.P.M.max.	Box
YT-4763	100	12500	8/64

YATO	Ø (mm)	R.P.M.max.	Box
YT-4764	125	10000	8/48

GB Cup brush
D Stahldraht-Topfbürste
PL Szczotka czolowa z gwintem

RUS Щетка "чашка"
CZ Čelní kartáč drátěný
H Homlok drótkefe

RO Perie frontală
F Brosse coupe avec filet
I Spazzola conica

E Cepillo de copa
CN 钢丝轮

COLOR BOX



M14



INOX
STAINLESS STEEL
ÉTEL, NIKROZEL

YATO	Ø (mm)	R.P.M.max.	Box
YT-4766	100	8500	4/32

YATO	Ø (mm)	R.P.M.max.	Box
YT-4767	60	12500	10/80

YATO	Ø (mm)	R.P.M.max.	Box
YT-4768	75	11000	6/36

YATO	Ø (mm)	R.P.M.max.	Box
YT-4769	100	8500	4/16

GB Insulated cable knife
D Kabelmesser gerade
PL Nóż dla elektryków izolowany

RO Cutit pt. cabluri izolat
F Couteau d'électricien
I Coltello per elettricisti isolato

RUS Нож кабельный изолированный

E Cuchillo electricista aislante
CN 绝缘电工刀

CZ Izolovaný nůž
H Szerelőké

180 mm

50 mm

65 Mn

1000 V

DVE

GB Insulated dismantling knife
D Abmantelungsmesser
PL Nóż demontażowy dla elektryków

H Szerelőké
RO Cutit demontabil izolat
F Couteau d'électricien
I Coltello di smontaggio per elettricisti isolati

RUS Нож кабельный изолированный

E Cuchillo de desmontaje aislante
CN 绝缘电工刀

CZ Zahnutý nůž s vodítkem, izolovaný

155 mm

38 mm

65 Mn

1000 V

DVE



POLYBAG



1000V VDE CERTIFICATE EN 60900:2012

YATO	L (mm)	Box
YT-21210	180	6/72



POLYBAG



1000V VDE CERTIFICATE EN 60900:2012

YATO	L (mm)	Box
YT-21211	155	6/72

GB Electrician's knife
D Montagemesser
PL Nóż składany monterski
RUS Нож складной

CZ Montážní nůž
H Szerelőkés
RO Cuiț pt. decablat
F Couteau d'électricien

I Coltello
E Cuchillo de montaje
CN 电工刀

SLIDING
CARD



3CR13

HRC
42-48

85 mm

200 mm



75 mm

190 mm



YATO	L (mm)	
YT-7600	200	6/96

YATO	L (mm)	
YT-7601	190	6/96

GB Folding knife
with bits
D Klappmesser
PL Nóż składany
z bitami

RUS Нож складной
CZ Kapesní nůž
H Zsebkés
RO Briceag

F Couteau pince
multifonction
avec embouts
I Coltello pieghevole
con punte

E Navaja
CN 旋具头折叠刀

BLISTER
CARD

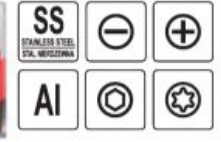

3, 4 mm;
PH1, PH2;

3, 4 mm;
T10, T20

YATO		
YT-76031		6/48

GB Folding knife
D Klappmesser
PL Nóż składany
RUS Нож складной

CZ Kapesní nůž
H Zsebkés
RO Briceag
F Couteau pliant

I Coltello
pieghevole
E Navaja
CN 折叠刀

SLIDING
CARD



SS
STAINLESS STEEL
STL. MROZOWANA



AI



YATO		
YT-76050		12/72



YATO		
YT-76051		12/120



YATO		
YT-76052		6/48

GB Multi knife
D Klappmesser
PL Narzędzie wielofunkcyjne
RUS Нож складной
CZ Kapesní nůž
H Zsebkés
RO Briceag
F Couteau pince multifonction
I Pinze universale
E Navaja
CN 多功能折叠刀

BLISTER
CARD



9
PCS

SS
STAINLESS STEEL
STL. MROZOWANA

AI



AI



YATO		
YT-76040		12/120

YATO		
YT-76041		12/48

GB Multi knife
D Klappmesser
PL Narzędzie wielofunkcyjne
RUS Нож складной

CZ Kapesní nůž
H Zsebkés
RO Briceag
F Couteau pince multifonction

I Pinze universale
E Navaja
CN 多功能折叠刀

BLISTER CARD



9 PCS

SS
STAINLESS STEEL
DIN 18240/24



AI



YATO

YT-76042



12/48

YATO

YT-76043



6/36

GB Cutter knife
D Universalmesser
PL Nożyk z ostrzem trapezowym
RUS Ножи универсальные

CZ Univerzální nůž
H Univerzális kés
RO Cutiți universal

F Couteau lames trapézoïdale
I Coltellino con lama trapezoidale

E Cutter con filo trapezoidal
CN 实用刀

SK5



x5

x5

YATO

YT-7532

(mm)
61x33x0.5



12/72

YATO

YT-7534

(mm)
61x33x0.5



12/72

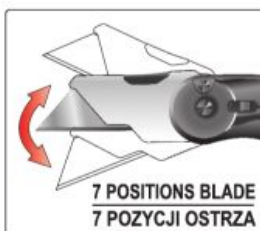

7 POSITIONS BLADE
7 POZYCJI OSTRZA

AI

LOCK
BLOKADA

SLIDING CARD



YATO

YT-76060

(mm)
61x33x0.5



6/48



x3

YATO

YT-7520

(mm)
61x33x0.5



6/48

TRY ME
DOUBLE
BLISTER



STRAP SIDE CUTTER
OBCINAK BOCZNY

1+3

Zn
TPR
ABS

AUTO
RETRACTABLE
AUTOMATYCZNE
ODCIĄGANIE OSTRZA

MULTI-STOP
3 POZYCJE
WYSUWANIA

DOUBLE
BLISTER



YATO

YT-75201

(mm)
61x33x0.5



12/144

- GB Utility knife
D Universalmesser
PL Nożyk z łamanym ostrzem
RUS Нож универсальный
CZ Nůž na tapety
H Tapétaolló
- RO Cuțitaș pt. tapet
F Cutter à lames sécables
I Taglierino
E Cuchillo para papel de empapelar
CN 美工刀



- 1+2 ABS TPR AUTO LOCK BLOKADA METAL SLIDING BAR METALOWA PRZEWADNICA SELF LOADING AUTOMATYCZNA WYMIANA OSTRZA SK5

YATO	(mm)	
YT-75001	9x0.4	12/144



- 1+3 Zn max. 20 kg BLADE PULL FORCE BEZ WYPOSAŻENIA OSTRZA AUTO LOCK BLOKADA METAL SLIDING BAR METALOWA PRZEWADNICA BLADE STABILIZATION STABILIZACJA OSTRZA SELF LOADING AUTOMATYCZNA WYMIANA OSTRZA SK5

YATO	(mm)	
YT-75811	18x0.5	12/144



- x3 AL HANDLE SK5

YATO	(mm)	
YT-7581	18x0.4	20/80



- Zn TPR ABS max. 20 kg BLADE PULL FORCE BEZ WYPOSAŻENIA OSTRZA AUTO LOCK BLOKADA METAL SLIDING BAR METALOWA PRZEWADNICA SK5

YATO	(mm)	
YT-75121	18x0.5	12/144

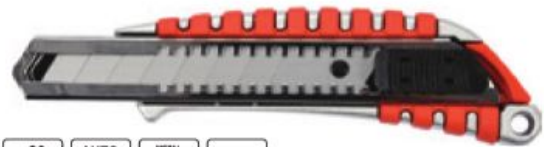

- Zn TPR max. 20 kg BLADE PULL FORCE BEZ WYPOSAŻENIA OSTRZA AUTO LOCK BLOKADA METAL SLIDING BAR METALOWA PRZEWADNICA SK5

YATO	(mm)	
YT-75122	18x0.5	12/144



SK2

YATO	(mm)	
YT-7511	9x0.4	24/288
YT-7512	18x0.5	12/96



- ABS TPR LOCK SK2

YATO	(mm)	
YT-7506	9x0.4	24/240
YT-7507	18x0.5	12/144



- ABS TPR max. 20 kg BLADE PULL FORCE BEZ WYPOSAŻENIA OSTRZA AUTO LOCK BLOKADA METAL SLIDING BAR METALOWA PRZEWADNICA SK5

YATO	(mm)	
YT-75071	18x0.5	12/144



- ABS TPR max. 20 kg BLADE PULL FORCE BEZ WYPOSAŻENIA OSTRZA AUTO LOCK BLOKADA METAL SLIDING BAR METALOWA PRZEWADNICA SK5

YATO	(mm)	
YT-75072	18x0.5	12/144



- ABS SK2

YATO	(mm)	
YT-7504	9x0.4	24/240
YT-7505	18x0.5	24/240



- ABS TPR max. 20 kg BLADE PULL FORCE BEZ WYPOSAŻENIA OSTRZA AUTO LOCK BLOKADA METAL SLIDING BAR METALOWA PRZEWADNICA SK5

YATO	(mm)	
YT-75101	25x0.7	12/144

- GB Spare blades
D Abbrechklingen
PL Ostrza zapasowe
RUS Лезвия для универсальных ножей
CZ Lomené ostří náhradní
H Törhető tartalékpenge
- RO Lame de rezervă rupte
F Lame sécables pour le cutter
I Lame di ricambio
E Filo partido de recambio
CN 美工刀刀片

PLASTIC BOX & SLIDING CARD



10 PCS

SK5	YATO	(mm)	
	YT-7530	25x0.7	6/48



SK5	YATO	(mm)	
	YT-7528	9x0.4	24/144
	YT-7529	18x0.5	24/144

SK5	YATO	(mm)	
	YT-7531	61x33x0.5	24/144



SK2	YATO	(mm)	
	YT-7524	9x0.4	24/240
	YT-7525	18x0.5	24/144



SK2	YATO	(mm)	
	YT-7527	61x33x0.5	24/144

- GB Insulated electrician scissors
 D Elektrische Schere
 PL Nożyczki dla elektryków izolowane
 RUS Ножницы диэлектрические универсальные
 CZ Elektrické nůžky
 H Univerzális olló
 RO Foarfece - electrician izolate
 F Ciseaux pour electriciens
 I Forbici per elettricisti
 E Tijeras eléctricos
 CN 绝缘电工剪



1000V VDE CERTIFICATE EN 60900:2012

YATO	L (mm)	
YT-21200	160	6/48

- GB Electrician scissors
 D Elektrische Schere
 PL Nożyczki dla elektryków
 RUS Ножницы универсальные
 CZ Elektrické nůžky
 H Univerzális olló
 RO Foarfece - electrician
 F Ciseaux pour electriciens
 I Forbici per elettricisti
 E Tijeras eléctricos
 CN 电工剪



YATO	L (mm)	
YT-1974	140	12/120

- GB Scissors
 D Haushaltsschere
 PL Nożyczki
 RUS Ножницы универсальные
 CZ Nůžky
 H Olló
- RO Foarfece
 F Ciseaux
 I Forbici
 E Tijeras
 CN 剪刀



YATO	L (mm)	
YT-19763	170	12/120
YT-19764	190	12/120
YT-19765	215	12/120
YT-19766	245	12/120
YT-19767	300	12/120

- GB Glass oil cutter
 D Glasschneider
 PL Nóż olejowy do szkła
 RUS Стеклопоз масляный
 CZ Rezák na sklo
- H Olajkés üveghez
 RO Diamant pt. taiat sticla cu ulei
 F Couteau à l'huile pour verre
 I Taglia vetro con serbatoio olio
- E Cuchillo de aceite para cristalinación
 CN 玻璃割刀



YATO	L (mm)	
YT-7560	177	6/120



YATO	L (mm)	
YT-7561	178	6/120

- GB Double edge trimmer
 D Kantentrimmer
 PL Dwustronny nóż do odcinania oklein
 RUS Двусторонний нож для мебельной пленки
 CZ Orezávací nůž na hrany lamina
 H Kétélű vágó
 RO Rindea pt. finisaje
 F Couteau reversible pour bois de placage
 I Doppio coltello
 E Cuchillo de doble filo para cortar chapas de madera
 CN 双边刨子



YATO		
YT-5710		6/48

- GB Carving knife set
 D Klingensatz
 PL Zestaw nożyków
 RUS Набор резцов
 CZ Sada nožiků
 H Késkészlet
 RO Set de cuțite estav
 F Sculpture ensemble de couteau
 I Set di coltelli
 E Uego de cuchillas
 CN 美工刀



YATO		
YT-75140		6/48

- GB Scriber for glass, ceramics and metal
 D Reißnadel für Glas, Keramik und Metall
 PL Rysik do szkła, ceramiki i metalu
 RUS Штихель для стекла, керамика и металла
- CZ Rýsovací jehla na sklo, keramiku a kov
 H Karctű üveghez, kerámiához és fémhez
 RO Ac de trasat pt. sticlă, ceramică și metal
 F Stylet verre, céramique et métal
- I Penna di vetro ceramica metallo
 E Trazador para vidrio, cerámica y metal
 CN 划线器



YATO	L (mm)	
YT-3740	140	6/240

- GB Automatic center punch
 D Automatischer Körner Einstellbare
 PL Punktak automatyczny
 RUS Автоматический кернер
 CZ Automatické důlčikem
 H Automatikus központ puncs
- RO Punctator automat
 F Pointeau automatique
 I Bulino automatico
 E Centro automático punch
 CN 自动中心冲



YATO	L (mm)	
YT-47160	125	12/72

- GB Adjustable automatic center punch
 D Einstellbare automatische Körners
 PL Punktak automatyczny regulowany
 RUS Регулируемое автоматическое кернер
 CZ Nastavitelné automatické důlčikem
 H Automatikus központ puncs
 RO Punctator ajustabil automat
 F Pointeau automatique réglable
 I Bulino automatico regolabile
 E Ajustable centro automático punch
 CN 可调中心冲



YATO	L (mm)	
YT-47161	125	12/72

- GB Steel contour gauge
D Profilmuster
PL Wzornik do kopiowania kształtów
RUS Шаблон профилей
CZ Profilová šablona
H Profilsablon
RO Șablon profil
F Jauges d'épaisseurs métriques
I Sagoma di contorno
E Plantilla de perfiles
CN 仿形规

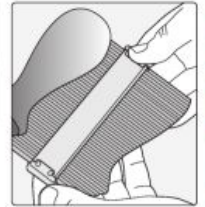

YATO	
YT-70870	12/48

- GB Profile gauge
D Profilmuster
PL Wzornik profili
RUS Шаблон профилей
CZ Profilová šablona
H Profilsablon
RO Șablon profil
F Jauges d'épaisseurs métriques
I Profilato
E Plantilla de perfiles
CN 轮廓仪



YATO	L (mm)	
YT-3735	125	24/72

YATO	L (mm)	
YT-3736	260	10/40

- GB Leather punch
D Lederlocher
PL Przebijak do skóry
RUS Круглый пробойник для кожи
CZ Průbojník na kůži
H Bőryukasztó
RO Preducele
F Perçoirs à cuir
I Punterulolo per pelle
E Perforar en piel
CN 皮带冲



YATO	Ø (mm)	
YT-35850	2	20/100
YT-35851	3	20/100
YT-35852	4	20/100
YT-35853	5	20/100
YT-35854	6	20/100
YT-35855	7	20/100

YATO	Ø (mm)	
YT-35856	8	20/100
YT-35857	9	20/100
YT-35858	10	20/100
YT-35859	11	20/100
YT-35860	12	20/100
YT-35861	13	20/100

YATO	Ø (mm)	
YT-35862	14	20/100
YT-35863	15	20/100
YT-35864	16	20/100
YT-35865	17	20/100
YT-35866	18	20/100
YT-35867	19	20/80

YATO	Ø (mm)	
YT-35868	20	20/80
YT-35869	21	20/60
YT-35870	22	20/80
YT-35871	23	10/50
YT-35872	24	20/60
YT-35873	25	20/60

- GB Punch set
D Lederlocherstet
PL Przebijaki do skóry
RUS Набор пробойников для кожи
CZ Sada průbojníků na kůži
H Bőryukasztó készlet
RO Set preducele
F Kit de perçoirs à cuir
I Set di punzoni
E Juego de perforar en piel
CN 冲孔器组套



3
PCS

4
PCS

YATO	Ø (mm)	
YT-35881	6; 8; 10	20/120

YATO	Ø (mm)	
YT-35880	2; 3; 4; 5	20/120

- GB Punch set
D Lederlocherstet
PL Przebijaki do skóry
RUS Набор пробойников для кожи
CZ Sada průbojníků na kůži
H Bőryukasztó készlet
RO Set preducele
F Kit de perçoirs à cuir
I Set di punzoni
E Juego de perforar en piel
CN 冲孔器组套



POUCH & COLOR BOX



9
PCS

15
PCS

YATO	Ø (mm)	
YT-3590	2.5; 3.0; 4.0; 5.0; 6.0; 7.0; 8.0; 9.0; 10.0	50

YATO	Ø (mm)	
YT-3591	2.0; 2.5; 3.2; 4.0; 4.8; 5.5; 6.4; 8.0; 9.5; 11.1; 12.7; 14.0; 15.8; 19.0; 22.0	10

- GB PVC pipe cutter
- D PVC Rohrabsschneider
- PL Obcinak do rur PCV
- RUS Труборез для ПВХ труб
- CZ Rezač PVC trubek
- H Csővágó olló PVC csövekhez
- RO Clește pt. tăiat țevi din PVC
- F Coupeur aux tubes
- I Taglia tubi PVC
- E Cortatubos PVC
- CN PVC 管子割刀



∅ max (mm)	PEX AL PEX	PVC PP PU PE	8Cr13 STAINLESS STEEL STAL NIERDZEWNA	HRC 54
------------	------------	--------------	---------------------------------------	--------

SLIDING CARD

YATO	max. ∅ (mm)	
YT-2230	35	6/48

- GB PVC pipe cutter
- D PVC Rohrabsschneider
- PL Obcinak do rur PCV
- RUS Труборез для ПВХ труб
- CZ Rezač PVC trubek
- H Csővágó olló PVC csövekhez
- RO Clește pt. tăiat țevi din PVC
- F Coupeur aux tubes
- I Taglia tubi PVC
- E Cortatubos PVC
- CN PVC 管子割刀



∅ max (mm)	PEX AL PEX	PVC PP PU PE	8Cr13 STAINLESS STEEL STAL NIERDZEWNA	HRC 54	RATCHET SYSTEM ZAPADKOWY	QUICK RELEASE SZYBKIE ZWALNIANIE
------------	------------	--------------	---------------------------------------	--------	--------------------------	----------------------------------

SLIDING CARD

YATO	max. ∅ (mm)	
YT-2231	42	6/48

- GB PVC pipe cutter
- D PVC Rohrabsschneider
- PL Obcinak do rur PCV
- RUS Труборез для ПВХ труб
- CZ Rezač PVC trubek
- H Csővágó olló PVC csövekhez
- RO Clește pt. tăiat țevi din PVC
- F Coupeur aux tubes
- I Taglia tubi PVC
- E Cortatubos PVC
- CN PVC 管子割刀



∅ max (mm)	PEX AL PEX	PVC PP PU PE	8Cr13 STAINLESS STEEL STAL NIERDZEWNA	HRC 56-58	RATCHET SYSTEM ZAPADKOWY	QUICK RELEASE SZYBKIE ZWALNIANIE
------------	------------	--------------	---------------------------------------	-----------	--------------------------	----------------------------------

SLIDING CARD

YATO	max. ∅ (mm)	
YT-2232	63	6/24

- GB PVC pipe cutter
- D PVC Rohrabsschneider
- PL Obcinak do rur PCV
- RUS Труборез для ПВХ труб
- CZ Rezač PVC trubek
- H Csővágó olló PVC csövekhez
- RO Clește pt. tăiat țevi din PVC
- F Coupeur aux tubes
- I Taglia tubi PVC
- E Cortatubos PVC
- CN PVC 管子割刀



SLIDING CARD

PEX AL PEX	PVC PP PU PE	8Cr13 STAINLESS STEEL STAL NIERDZEWNA	HRC 54	AI	RATCHET SYSTEM ZAPADKOWY	QUICK RELEASE SZYBKIE ZWALNIANIE
------------	--------------	---------------------------------------	--------	----	--------------------------	----------------------------------

∅ max (mm)	51
------------	----

YATO	max. ∅ (mm)	
YT-2228	51	6/24



∅ max (mm)	64
------------	----

YATO	max. ∅ (mm)	
YT-2229	64	6/24

- GB Pipe cutter
- D Rohrabsschneider
- PL Obcinak do rur
- RUS Труборез для труб
- CZ Rezač trubek
- H Csővágó olló csövekhez
- RO Clește pt. tăiat țevi
- F Coupeurs aux tubes
- I Rullo di taglio per tubi
- E Cortatubos
- CN 管子割刀

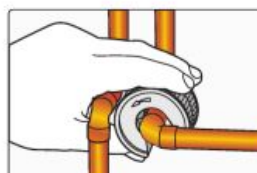

PEX	PLASTIC Al, Cu	SEALING STEEL STAL IZOPROKNA
-----	----------------	------------------------------

SLIDING CARD

YATO	∅	external diameter / średnica zewnętrzna (mm)	
YT-22353	19/32" (15 mm)	48	5/50
YT-22354	23/32" (18 mm)	59	10/50
YT-22355	7/8" (22 mm)	56	10/50

GB Pipe cutter
D Rohrabsschneider
PL Obcinak do rur
RUS Труборіз для труб

CZ Řezač trubek
H Csővágó olló
RO Clește pt. tăiat țevi

F Coupeur aux tubes
I Taglia tubi PVC
E Cortatubos
CN 管子割刀

COLOR BOX



PEX



PLASTIC
Al, Cu
Ø 1/10" - 7/8"
Ø 3-22 mm



YATO Ø
YT-22318 1/10"-7/8" (3-22 mm) 100



PLASTIC
Al, Cu
Ø 1/10" - 5/4"
Ø 3-32 mm

QUICK-ADJUSTMENT
SZYBKONASTAWNY

WITH DEBURRER
Z GRATOWNIKIEM



YATO Ø
YT-22338 1/10"-5/4" (3-32 mm) 50



PLASTIC
STEEL
Al, Cu
Ø 3/8" - 1-5/8"
Ø 10-40 mm



YATO Ø
YT-2232 3/8"-1-5/8" (10-40 mm) 20



PLASTIC
Al, Cu
Ø 1/4" - 7/4"
Ø 6-45 mm

WITH DEBURRER
Z GRATOWNIKIEM



YATO Ø
YT-2233 1/4"-7/4" (6-45 mm) 25



PLASTIC
Al, Cu
Ø 1/2" - 5/2"
Ø 14-63 mm

QUICK-ADJUSTMENT
SZYBKONASTAWNY



YATO Ø
YT-2234 1/2"-5/2" (14-63 mm) 25



PLASTIC
Al, Cu
Ø 2" - 5"
Ø 50-127 mm

QUICK-ADJUSTMENT
SZYBKONASTAWNY



YATO Ø
YT-2235 2"-5" (50-127 mm) 10

GB Replacement cutting wheel
for pipe cutters
D Ersatzschneidrad
für Rohrabsschneider
PL Zapasowe kółko tnące
do obcinaka do rur
RUS Запасной режущий
диск для труборезов
CZ Náhradní řezné kolečko
na trubky frézy

H Tartalék vágókerék cső vágó
RO Roata de schimb pt. taiere țevi
F Molette pour coupe
I Taglio ruote tubo taglierina
E Rueda de corte
de repuesto para cortatubos
CN 管子割刀刀片

2
PCS
BEARING STEEL
ITAL LÖTSTROM



DOUBLE
BLISTER

YATO	a (mm)	b (mm)	c (mm)	for/dla:	
YT-22313	18	6	4.8	YT-2233	50/300
YT-22314	26	14	7.5	YT-2232	6/108
YT-22315	18	6	4.8	YT-22338	50/300
YT-22316	27	6.3	5	YT-2234	24/288

GB Replacement cutting wheel
for pipe cutters
D Ersatzschneidrad
für Rohrabsschneider
PL Zapasowe kółko tnące
do obcinaka do rur
RUS Запасной режущий
диск для труборезов
CZ Náhradní řezné kolečko
na trubky frézy

H Tartalék vágókerék cső vágó
RO Roata de schimb pt. taiere țevi
F Molette pour coupe
I Taglio ruote tubo taglierina
E Rueda de corte
de repuesto para cortatubos
CN 管子割刀刀片

BEARING STEEL
ITAL LÖTSTROM

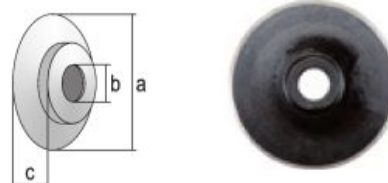

DOUBLE
BLISTER

YATO	a (mm)	b (mm)	c (mm)	for/dla:	
YT-22317	44	10.6	8	YT-2235	12/144

GB Window scraper / RO Răzuitor pt. geamuri / I Coltellino con lama trapezoidale / E Rascador de cristales
 D Fensterabstreicher / F Gratte-givre / CN 玻璃刮刀
 PL Skrobak do szyb
 RUS Скребок для стекла
 CZ Škrabák na skla
 H Kaparó üveghez

HALF
DOUBLE
BLISTER



YATO	L (mm)	
YT-7550	300	10/60



TELESCOPIC
HANDLE
390-600
mm

YATO	L (mm)	
YT-7551	390-600	10/60

GB Steel file / CZ Zámeňický pilník / I Lima per metallo
 D Werkstatt-Feile / H Lakatos reszelő / E Lima para metal
 PL Pilnik do metalu / RO Pilă de lăcătușerie / CN 锉
 RUS Напильник слесарный / F Lime à métal

#1 #2 #3 T12 STEEL 150 mm 200 mm 250 mm 300 mm



YATO	#	L (mm)	
YT-62228	1	150	20/80
YT-62229	1	200	20/80
YT-62223	1	250	20/80
YT-62231	1	300	10/40
YT-6180	2	150	20/80
YT-6185	2	200	20/80
YT-62228	2	250	20/80
YT-6190	2	300	10/40
YT-62328	3	150	20/80
YT-62329	3	200	20/80
YT-62333	3	250	20/80
YT-62331	3	300	10/40



YATO	#	L (mm)	
YT-62238	1	150	20/80
YT-62239	1	200	20/80
YT-6224	1	250	20/80
YT-62241	1	300	10/40
YT-6181	2	150	20/80
YT-6186	2	200	20/80
YT-62229	2	250	20/80
YT-6191	2	300	10/40
YT-62243	3	150	20/80
YT-62244	3	200	20/80
YT-62245	3	250	20/80
YT-62246	3	300	10/40

YATO	#	L (mm)	
YT-62248	1	150	20/80
YT-62249	1	200	20/80
YT-6225	1	250	20/80
YT-62251	1	300	10/40
YT-6182	2	150	20/80
YT-6187	2	200	20/80
YT-6230	2	250	20/80
YT-6192	2	300	10/40
YT-62338	3	150	20/80
YT-62339	3	200	20/80
YT-6234	3	250	20/80
YT-62341	3	300	10/40



YATO	#	L (mm)	
YT-62258	1	150	20/80
YT-62259	1	200	20/80
YT-6226	1	250	20/80
YT-62261	1	300	10/40
YT-6183	2	150	20/80
YT-6188	2	200	20/80
YT-6231	2	250	20/80
YT-6193	2	300	10/40
YT-62348	3	150	20/80
YT-62349	3	200	20/80
YT-6235	3	250	20/80
YT-62351	3	300	10/40

YATO	#	L (mm)	
YT-62268	1	150	20/80
YT-62269	1	200	20/80
YT-6227	1	250	20/80
YT-62271	1	300	10/40
YT-6184	2	150	20/80
YT-6189	2	200	20/80
YT-6232	2	250	20/80
YT-6194	2	300	10/40
YT-62358	3	150	20/80
YT-62359	3	200	20/80
YT-6236	3	250	20/80
YT-62361	3	300	10/40

- GB Steel file set
- D Werkstatt-Feilen
- PL Piłniki do metalu
- RUS Набор напильников слесарных
- CZ Zámečnické pilníky
- H Lakatos reszelő
- RO Pile de lăcătușerie
- F Set de limes à métal
- I Lime per metallo
- E Juego de limas para metal
- CN 钢锉组套



#1 #2 #3 250 mm T12 STEEL

3 PCS #2 #2 #2

YATO  YT-6237 10/20



5 PCS #1 #2 #1 #1 #1

YATO  YT-6238 5/10



5 PCS #3 #3 #3 #3 #3

YATO  YT-6239 5/10

- GB Needle file set
- D Nadelfeilenatz
- PL Zestaw pilników iglaków

- RUS Набор напильников надфили
- CZ Sada jehlových pilníků
- H Túreszelő készlet

- RO Set pile conice
- F Set de limes
- I Set di lime e lime ad ago

- E Juego de limas de aguja
- CN 什锦锉组套

POUCH



GCR15 BEARING STEEL



6 PCS EQUALLING PLASKI SQUARE CZWOROKĄTNY THREE-SQUARE TRÓJKĄTNY FLAT WARDING PŁASKI ZBIĘTY ROUND OKRĄGŁY HALF-ROUND PÓŁOKRĄGŁY

6 PCS EQUALLING PLASKI SQUARE CZWOROKĄTNY THREE-SQUARE TRÓJKĄTNY CROSSING SOCZEWKOWY ROUND OKRĄGŁY HALF-ROUND PÓŁOKRĄGŁY

YATO  working length / długość robocza (mm) mm 50/200

YT-6160 65 3x140

YATO  working length / długość robocza (mm) mm 25/100

YT-6161 75 4x160

YT-6162 85 5x180

GB Needle file set
D Nadelfeilsatz
PL Zestaw pilników iglaków

RUS Набор напильников надфили
CZ Sada jehlových pilníků
H Tűreszelő készlet

RO Set pile conice
F Set de limes
I Set di lime e lime ad ago

E Juego de limas de aguja
CN 什锦锉组套

POUCH



GCR15 BEARING STEEL

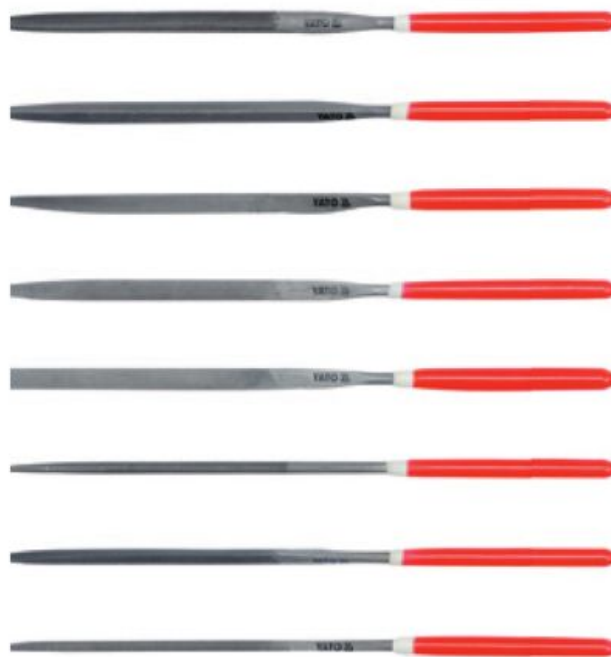

10 PCS



YATO	working length / długość robocza (mm)	mm	
YT-6163	65	3x140	25/100

10 PCS



YATO	working length / długość robocza (mm)	mm	
YT-6164	75	4x160	25/100
YT-6165	85	5x180	25/50

GB Diamond needle file
D Diamant-Nadelfeile
PL Pilnik iglak diamentowy
RUS Надфиль алмазный

CZ Diamantový jehlový pilník
H Gyémánt tűreszelő
RO Pila diamantata
F Lime diamant

I Lime ad ago diamantate
E Lima de aguja adiamantada
CN 金刚石平头扁锉

SLIDING CARD

GRIT ZIARNISTOŚĆ 150



YATO	grit / ziarnistość	coating length / długość nasypu (mm)	mm	
YT-6140	150	50	3x140	120/1200
YT-6147	150	50	4x160	80/800
YT-6152	150	70	5x180	45/450

YATO	grit / ziarnistość	coating length / długość nasypu (mm)	mm	
YT-6141	150	50	3x140	120/1200
YT-6148	150	50	4x160	80/800
YT-6153	150	70	5x180	45/450

YATO	grit / ziarnistość	coating length / długość nasypu (mm)	mm	
YT-6142	150	50	3x140	120/1200
YT-6149	150	50	4x160	80/800
YT-6154	150	70	5x180	45/450

GB Diamond needle file set
D Diamant-Nadelfeilsatz
PL Zestaw pilników diamentowych iglaków
RUS Набор надфилей алмазных
CZ Sada diamantových jehlových pilníků
H Gyémánt tűreszelő készlet

RO Set pile diamantate
F Set de limes diamant
I Set lime ad ago diamantate
E Juego de limas de aguja adiamantadas
CN 金刚石整形锉组套

POUCH

GRIT ZIARNISTOŚĆ 150

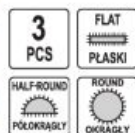

YATO	grit / ziarnistość	coating length / długość nasypu (mm)	mm	
YT-6143	150	50	3x140	40/400
YT-6150	150	50	4x160	30/300
YT-6155	150	70	5x180	15/150

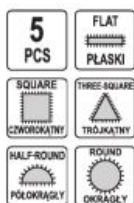

YATO	grit / ziarnistość	coating length / długość nasypu (mm)	mm	
YT-6156	150	70	5x180	10/100

GB Diamond needle file set
D Diamant-Nadelfeileinsatz
PL Zestaw pilników diamentowych iglaków
RUS Набор надфилей алмазных
CZ Sada diamentových jehlových pilníků
H Gyémánt tűreszelő készlet

RO Set pile diamantate
F Set de limes diamant
I Set lime ad ago diamantate
E Juego de limas de aguja adiamantadas
CN 金刚石整形锉组套

POUCH



10
PCS

GRIT
ZIARNISTOŚĆ
150



10



YATO	grit / ziarnistość	coating length / długość nasypu (mm)	mm	
YT-6144	150	50	3x140	12/120



YATO	grit / ziarnistość	coating length / długość nasypu (mm)	mm	
YT-6146	150	30	3x140	12/120



YATO	grit / ziarnistość	coating length / długość nasypu (mm)	mm	
YT-6145	150	25	3x140	12/120



YATO	grit / ziarnistość	coating length / długość nasypu (mm)	mm	
YT-6151	150	50	4x160	9/90

- GB Diamond sharpening file
 D Diamant-schärfen-Datei
 PL Oselka diamentowa - pilnik
 RUS Напильник алмазный
 CZ Diamantový pilník
 H Gyémánt reszelők
 RO Pila diamantata pt. ascutit
- F Fichier de diamant
 I Pietra diamentata - lima
 E Archivo de afilado de diamante
 CN 金刚石锉刀



DOUBLE BLISTER



YATO	grit / ziarnistość	L (mm)	
YT-76080	240/400	250	12/48

- GB Diamond whetstone
 D Diamant Schleifstein
 PL Oselka diamentowa - blok
 RUS Алмазный брусок
 CZ Diamond brousek
 H Kétoldalas gyémánt fenékő
 RO Piatra abraziva diamentata
 F Affiloir diamanté
 I Pietra diamentata
 E Piedra de afilar diamentada
 CN 金刚石磨刀石



DOUBLE BLISTER

YATO	grit / ziarnistość	coating length / długość nasypu (mm)	mm	
YT-76085	300	50	4x150	10/60
YT-76086	400	50	4x150	10/60
YT-76087	600	50	4x150	10/60

- GB Wood rasp
 D Holzraspel
 PL Tarnik do drewna
 RUS Рапиля для дерева
- CZ Rašple do dřeva
 H Fareszelő
 RO Raspe
 F Lime à bois
- I Lime per legno
 E Escarpelo para madera
 CN 木工挫

PLASTIC HANGER



#45	YATO	#		#45	YATO	#		#45	YATO	#	
	YT-6220	45	12/72		YT-6219	45	12/72		YT-6221	45	12/72

- GB Wood rasp set
 D Holzraspelsatz
 PL Tarniki do drewna
 RUS Рапили для дерева
 CZ Sada rašplí do dřeva
 H Fareszelő
 RO Set raspe
- F Set de limes à bois
 I Lime per legno
 E Juego de escarpelos para madera
 CN 木工挫组套



SLIDING CARD

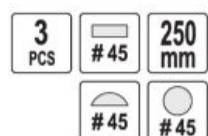

YATO	#	
YT-6222	45	5/20

- GB Rasp for plaster
 D Gipskartonplatten Rasp
 PL Tarnik do gipsu
 RUS Рапиль для гипсокартона
 CZ Rašple pro omítky
 H Reszelt vakolat
 RO Rasp pt. tencuiala
 F Râpe pour plâtre
 I Raspa per gesso
 E Eliminador de yeso
 CN 挫刨



SLIDING CARD



YATO	size / rozmiar (mm)	
YT-61678	140x40	15/60

- GB Blade for rasp
 D Sägeblattraspel
 PL Ostrze zapasowe do tarnika
 RUS Лезвие для рапиля по гипсокартону
 CZ Čepel do škrabacích
 H Penge reszelő
 RO Lama pt. rasp
 F lame râpe
 I Lama di ricambio per raspa
 E Hoja para raspar
 CN 挫刨刀片

SLIDING CARD

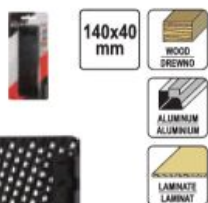

YATO	size / rozmiar (mm)	
YT-61679	140x40	10/120

for / dla: YT-61678

- GB Rasp for plaster
 D Gipskartonplatten Rasp
 PL Tarnik do gipsu
 RUS Рапиль для гипсокартона
 CZ Rašple pro omítky
- H Reszelt vakolat
 RO Rasp pt. tencuiala
 F Râpe pour plâtre
 I Raspa per gesso
 E Eliminador de yeso
 CN 挫刨

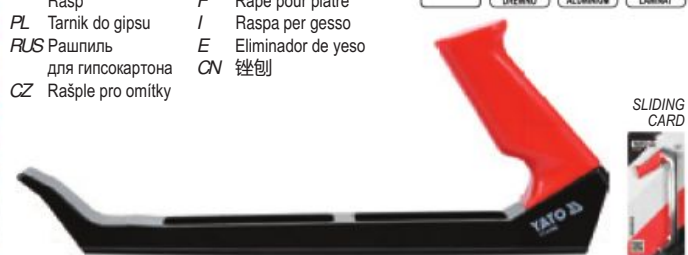

SLIDING CARD

YATO	size / rozmiar (mm)	
YT-61680	250x40	15/60

- GB Blade for rasp
 D Sägeblattraspel
 PL Ostrze zapasowe do tarnika
 RUS Лезвие для рапиля по гипсокартону
 CZ Čepel do škrabacích
 H Penge reszelő
- RO Lama pt. rasp
 F lame râpe
 I Lama di ricambio per raspa
 E Hoja para raspar
 CN 挫刨刀片

TIED ON CARD



YATO	size / rozmiar (mm)	
YT-61681	250x40	30/120

for / dla: YT-61680

- GB Rasp for plaster
 D Gipskartonplatten Rasp
 PL Tarnik do gipsu
 RUS Рапиль для гипсокартона
 CZ Rašple pro omítky
- H Reszelt vakolat
 RO Rasp pt. tencuiala
 F Râpe pour plâtre
 I Raspa per gesso
 E Eliminador de yeso
 CN 挫刨

SLIDING CARD

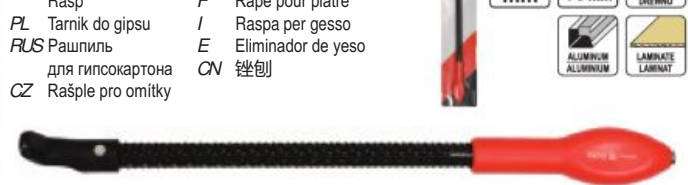

YATO	L (mm)	
YT-61690	260	15/60

- GB Blade for rasp
 D Sägeblattraspel
 PL Ostrze zapasowe do tarnika
 RUS Лезвие для рапиля по гипсокартону
 CZ Čepel do škrabacích
 H Penge reszelő
- RO Lama pt. rasp
 F lame râpe
 I Lama di ricambio per raspa
 E Hoja para raspar
 CN 挫刨刀片

SLIDING CARD



YATO	L (mm)	
YT-61691	260	10/120

for / dla: YT-61690

GB Sand paper PL Papier ścierny CZ Smirkový papír RO Hârtie abrazivă I Carta vetrata CN 砂纸
D Schleifpapier RUS Наждачная бумага H Csiszolópapír F Papier abrasif E Papel de lija



POLYBAG



- application: paint, lacquer, filler, wood
- abrasive: aluminium oxide
- bond: synthetic resin
- backing: C
- coating: semi-open

- zastosowanie: farby, lakiery, szpachle, drewno
- ścierniwo: tlenek glinu
- spoiwo: żywica syntetyczna
- podkład: C
- nasyp półotwarty

- application: paint, lacquer, filler, wood
- abrasive: aluminium oxide
- bond: synthetic resin
- backing: D
- coating: semi-open



- zastosowanie: farby, lakiery, szpachle, drewno
- ścierniwo: tlenek glinu
- spoiwo: żywica syntetyczna
- podkład: D
- nasyp półotwarty

YATO	grit / ziarnistość	size / rozmiar (mm)	PCS packing	
YT-8350	40	230x280	50	500
YT-8351	60	230x280	50	500
YT-8352	80	230x280	50	500
YT-8353	100	230x280	50	500
YT-8354	120	230x280	50	500
YT-8355	150	230x280	50	500
YT-8356	180	230x280	50	500
YT-8357	220	230x280	50	500
YT-8358	240	230x280	50	500

YATO	grit / ziarnistość	size / rozmiar	
YT-8449	40	93 mm x 5 m	12/48
YT-8450	60	93 mm x 5 m	12/48
YT-8451	80	93 mm x 5 m	12/48
YT-8452	100	93 mm x 5 m	12/48
YT-8453	120	93 mm x 5 m	12/48
YT-8454	150	93 mm x 5 m	12/48
YT-8455	180	93 mm x 5 m	12/48
YT-8456	240	93 mm x 5 m	12/48
YT-8457	320	93 mm x 5 m	12/48



POLYBAG WITH HEADER



- application: paint, lacquer, filler, wood
- abrasive: aluminium oxide
- bond: synthetic resin
- backing: D
- coating: semi-open

- zastosowanie: farby, lakiery, szpachle, drewno
- ścierniwo: tlenek glinu
- spoiwo: żywica syntetyczna
- podkład: D
- nasyp półotwarty

- application: paint, lacquer, filler, wood
- abrasive: aluminium oxide
- bond: synthetic resin
- backing: D
- coating: semi-open



- zastosowanie: farby, lakiery, szpachle, drewno
- ścierniwo: tlenek glinu
- spoiwo: żywica syntetyczna
- podkład: D
- nasyp półotwarty

YATO	grit / ziarnistość	size / rozmiar (mm)	PCS packing	
YT-8370	40	115x280	5	24/240
YT-8371	60	115x280	5	24/240
YT-8372	80	115x280	5	24/240
YT-8373	100	115x280	5	24/240
YT-8374	120	115x280	5	24/240
YT-8375	150	115x280	5	24/240
YT-8376	180	115x280	5	24/240
YT-8377	240	115x280	5	24/240
YT-8378	320	115x280	5	24/240

YATO	grit / ziarnistość	size / rozmiar	
YT-8440	40	115 mm x 5 m	12/48
YT-8441	60	115 mm x 5 m	12/48
YT-8442	80	115 mm x 5 m	12/48
YT-8443	100	115 mm x 5 m	12/48
YT-8444	120	115 mm x 5 m	12/48
YT-8445	150	115 mm x 5 m	12/48
YT-8446	180	115 mm x 5 m	12/48
YT-8447	240	115 mm x 5 m	12/48
YT-8448	320	115 mm x 5 m	12/48



POLYBAG



- application: paint, lacquer, filler, wood
- abrasive: aluminium oxide
- bond: synthetic resin
- backing: D
- coating: semi-open

- zastosowanie: farby, lakiery, szpachle, drewno
- ścierniwo: tlenek glinu
- spoiwo: żywica syntetyczna
- podkład: D
- nasyp półotwarty

- application: paint, lacquer, filler, wood
- abrasive: aluminium oxide
- bond: synthetic resin
- backing: F
- coating: closed



- zastosowanie: farby, lakiery, szpachle, drewno
- ścierniwo: tlenek glinu
- spoiwo: żywica syntetyczna
- podkład: F
- nasyp pełny

YATO	grit / ziarnistość	size / rozmiar (mm)	PCS packing	
YT-8360	40	230x280	50	500
YT-8361	60	230x280	50	500
YT-8362	80	230x280	50	500
YT-8363	100	230x280	50	500
YT-8364	120	230x280	50	500
YT-8365	150	230x280	50	500
YT-8366	180	230x280	50	500
YT-8367	240	230x280	50	500
YT-8368	320	230x280	50	500

YATO	grit / ziarnistość	size / rozmiar	
YT-8483	40	200 mm x 50 m	2
YT-8484	60	200 mm x 50 m	2
YT-8485	80	200 mm x 50 m	2
YT-8486	120	200 mm x 50 m	2

GB Sand paper *RUS* Наждачная бумага *RO* Hârtie abrazivă *E* Papel de lija *POLYBAG*
D Schleifpapier *CZ* Smirkový papír *F* Papier abrasif *CN* 砂纸



- application: paint, lacquer, filler
- abrasive: silicon carbide
- bond: synthetic resin
- backing: C
- coating: closed

YATO	grit / ziarnistość	size / rozmiar (mm)	PCS packing
YT-8400	60	230x280	50 500
YT-8401	80	230x280	50 500
YT-8402	100	230x280	50 500
YT-8403	120	230x280	50 500
YT-8404	150	230x280	50 500

YATO	grit / ziarnistość	size / rozmiar (mm)	PCS packing
YT-8405	180	230x280	50 500
YT-8406	220	230x280	50 500
YT-8407	240	230x280	50 500
YT-8408	280	230x280	50 500
YT-8409	320	230x280	50 500
YT-8410	360	230x280	50 500
YT-8411	400	230x280	50 500

YATO	grit / ziarnistość	size / rozmiar (mm)	PCS packing
YT-8412	500	230x280	50 500
YT-8413	600	230x280	50 500
YT-8414	800	230x280	50 500
YT-8415	1000	230x280	50 500
YT-8416	1200	230x280	50 500
YT-8417	1500	230x280	50 500
YT-8418	2000	230x280	50 500

GB Abrasive cloth sheet *RO* Coli panza abraziva
D Schleifgewebe blatt *F* Tissu abrasif
PL Płótno ściernie arkusz *I* Carta vetrata
RUS Шлифовальное полотно *E* Hojas de pano abrasivo
CZ Brusné plátno *CN* 砂布
H Csiszolóvászon lap



- application: metal, wood
- abrasive: aluminium oxide
- bond: semi-resin
- backing: J
- coating: close



YATO	grit / ziarnistość	size / rozmiar (mm)	PCS packing
YT-83160	36	230x280	50 250
YT-83161	40	230x280	50 250
YT-83162	60	230x280	50 250
YT-83163	80	230x280	50 250

YATO	grit / ziarnistość	size / rozmiar (mm)	PCS packing
YT-83164	100	230x280	50 250
YT-83165	120	230x280	50 500
YT-83166	150	230x280	50 500
YT-83167	180	230x280	50 500

YATO	grit / ziarnistość	size / rozmiar (mm)	PCS packing
YT-83168	220	230x280	50 500
YT-83169	240	230x280	50 500

GB Abrasive cloth roll *RUS* Рулон-шлифовальное полотно *RO* Rola panza abraziva *E* Rollo de pano abrasivo
D Schleifgewebe rolle *CZ* Brusný plátno role *F* Tissu abrasif rouleau *CN* 砂布
PL Płótno ściernie rolka *H* Csiszolóvászon tekercs *I* Carta vetrata rotolo



- application: metal, wood
- abrasive: aluminium oxide
- bond: semi-resin
- backing: J
- coating: close
- zastosowanie: metal, drewno
- ścierniwo: tlenek glinu
- spoiwo: żywica
- podkład: J
- nasyp pełny

YATO	grit / ziarnistość	size / rozmiar	PCS packing
YT-83181	40	150 mm x 30 m	2

YATO	grit / ziarnistość	size / rozmiar	PCS packing
YT-83182	50	150 mm x 50 m	2
YT-83183	60	150 mm x 50 m	2
YT-83184	80	150 mm x 50 m	2
YT-83185	100	150 mm x 50 m	2
YT-83186	120	150 mm x 50 m	2
YT-83187	150	150 mm x 50 m	2
YT-83188	180	150 mm x 50 m	2
YT-83190	240	150 mm x 50 m	2

YATO	grit / ziarnistość	size / rozmiar	PCS packing
YT-83200	24	200mm x 30 m	2
YT-83202	40	200mm x 30 m	2
YT-83203	50	200mm x 50 m	2
YT-83204	60	200mm x 50 m	2
YT-83205	80	200mm x 50 m	2
YT-83206	100	200mm x 50 m	2
YT-83207	120	200mm x 50 m	2
YT-83208	150	200mm x 50 m	2
YT-83209	180	200mm x 50 m	2
YT-83210	220	200mm x 50 m	2
YT-83211	240	200mm x 50 m	2

GB Endless sanding belt *RUS* Шлифовальные ленты *RO* Bandă de pânză *E* Pano abrasivo cinturón
D Schleifband *CZ* Brusný pás *F* Bande abrasive sans fin *CN* 砂带
PL Taśma ścierna bezkońcowa *H* Csiszoló szalag *I* Nastro abrasivo senza fine



HANGING COLOR BOX



- application: metal, wood
- abrasive: aluminium oxide
- bond: synthetic resin
- coating: close
- zastosowanie: metal, drewno
- ścierniwo: tlenek glinu
- spoiwo: żywica syntetyczna
- nasyp pełny

YATO	grit / ziarnistość	size / rozmiar (mm)	PCS packing
YT-09743	60	10x330	10 100
YT-09744	80	10x330	10 100
YT-09745	100	10x330	10 100
YT-09746	120	10x330	10 100

YATO	grit / ziarnistość	size / rozmiar (mm)	PCS packing
YT-09747	60	20x520	10 50
YT-09748	80	20x520	10 50
YT-09749	100	20x520	10 50
YT-09750	120	20x520	10 50

GB No end abrasive band
D Schleifband
PL Pas ścierny bezkońcowy

RUS Шлифлента бесконечная
CZ Brusný pás
H Csiszoló szalag

RO Curea abraziva
F Bande abrasive sans fin
I Nastro abrasivo senza fine

E Banda abrasiva sin fin
CN 砂带



- application: metal, wood
- abrasive: aluminium oxide
- bond: synthetic resin
- coating: close

- zastosowanie: metal, drewno
- ścierniwo: tlenek glinu
- spoiwo: żywica syntetyczna
- nasyp pełny

- application: metal, wood
- abrasive: aluminium oxide
- bond: synthetic resin
- coating: close

- zastosowanie: metal, drewno
- ścierniwo: tlenek glinu
- spoiwo: żywica syntetyczna
- nasyp pełny

- application: metal, wood
- abrasive: aluminium oxide
- bond: synthetic resin
- coating: close

- zastosowanie: metal, drewno
- ścierniwo: tlenek glinu
- spoiwo: żywica syntetyczna
- nasyp pełny

YATO	grit / ziarnistość	size / rozmiar (mm)	PCS packing
YT-83220	36	75x457	5 4/12
YT-83221	40	75x457	5 20/60
YT-83222	60	75x457	5 20/60
YT-83223	80	75x457	5 20/60
YT-83224	100	75x457	5 20/60
YT-83225	120	75x457	5 20/60

YATO	grit / ziarnistość	size / rozmiar (mm)	PCS packing
YT-83227	36	75x533	5 20/60
YT-83228	40	75x533	5 20/60
YT-83229	60	75x533	5 20/60
YT-83230	80	75x533	5 20/60
YT-83231	100	75x533	5 20/60
YT-83232	120	75x533	5 20/60
YT-83233	150	75x533	5 20/60

YATO	grit / ziarnistość	size / rozmiar (mm)	PCS packing
YT-83234	36	100x610	5 2/6
YT-83235	40	100x610	5 10/30
YT-83236	60	100x610	5 10/30
YT-83237	80	100x610	5 4/12
YT-83238	100	100x610	5 20/60
YT-83239	120	100x610	5 20/60
YT-83240	150	100x610	5 4/12

GB Flap disc – regular shape
D Fächerschleifscheibe - Gerade
PL Ściernica listkowa talerzowa płaska
RUS Круг лепестковый тарельчатый
CZ Lamelový brusný kotouč
H Lamellás csiszoló normál

RO Disc lamelar frontal
F Disque à lamelles abrasives plat
I Disco abrasivo per metallo
E Discos de paño abrasivo
CN 百叶轮

GB Flap disc – depressed shape
D Fächerschleifscheibe - Gewölbt
PL Ściernica listkowa talerzowa wypukła
RUS Круг лепестковый тарельчатый
CZ Lamelový brusný kotouč - vypouklý
H Lamellás csiszoló döntött

RO Disc lamelar frontal depresat
F Disque à lamelles abrasives bombé
I Disco abrasivo a centro depresso
E Discos de paño abrasivo centro embutido
CN 百叶轮

- application: metal
- abrasive: aluminium oxide
- bond: synthetic resin
- backing: fibreglass
- zastosowanie: metal
- ścierniwo: tlenek glinu
- spoiwo: żywica syntetyczna
- podkład: włókno szklane

- application: metal
- abrasive: aluminium oxide
- bond: synthetic resin
- backing: fibreglass
- zastosowanie: metal
- ścierniwo: tlenek glinu
- spoiwo: żywica syntetyczna
- podkład: włókno szklane



YATO	grit / ziarnistość	size / rozmiar (mm)	PCS
YT-83271	36	125x22.4	25/100
YT-83272	40	125x22.4	25/100
YT-83273	60	125x22.4	50/200
YT-83274	80	125x22.4	50/200
YT-83275	100	125x22.4	50/200
YT-83276	120	125x22.4	50/200

YATO	grit / ziarnistość	size / rozmiar (mm)	PCS
YT-83291	36	125x22.4	25/100
YT-83292	40	125x22.4	25/100
YT-83293	60	125x22.4	50/200
YT-83294	80	125x22.4	50/200
YT-83295	100	125x22.4	50/200
YT-83296	120	125x22.4	50/200

GB Flap wheel with shaft
D Fächerschleifmop mit Schaft
PL Ściernica listkowa trzpieniowa
RUS Круг лепестковый со шпинделем
CZ Lamelový kotouč s hřídelí
H Legyező csiszoló csapós

RO Perie abraziva circulara cu tija
F Disque à lamelles abrasives pivot
I Ruote lamellari

E Rueda laminar en tela abrasiva
CN 百叶轮

- application: metal
- abrasive: aluminium oxide
- bond: synthetic resin
- zastosowanie: metal
- ścierniwo: tlenek glinu
- spoiwo: żywica syntetyczna



- application: metal
- abrasive: aluminium oxide
- bond: synthetic resin
- zastosowanie: metal
- ścierniwo: tlenek glinu
- spoiwo: żywica syntetyczna



YATO	grit / ziarnistość	size / rozmiar (mm)	PCS
YT-83351	40	40x20x6	10/60
YT-83352	60	40x20x6	10/60
YT-83353	80	40x20x6	10/60
YT-83354	100	40x20x6	10/60
YT-83355	120	40x20x6	10/60
YT-83356	150	40x20x6	10/60

YATO	grit / ziarnistość	size / rozmiar (mm)	PCS
YT-83361	40	60x30x6	10/60
YT-83362	60	60x30x6	10/60
YT-83363	80	60x30x6	10/60
YT-83364	100	60x30x6	10/60
YT-83365	120	60x30x6	10/60
YT-83366	150	60x30x6	10/60

- application: metal
- abrasive: aluminium oxide
- bond: synthetic resin
- zastosowanie: metal
- ścierniwo: tlenek glinu
- spoiwo: żywica syntetyczna



- application: metal
- abrasive: aluminium oxide
- bond: synthetic resin
- zastosowanie: metal
- ścierniwo: tlenek glinu
- spoiwo: żywica syntetyczna



YATO	grit / ziarnistość	size / rozmiar (mm)	PCS
YT-83371	40	80x30x6	10/60
YT-83372	60	80x30x6	10/60
YT-83373	80	80x30x6	10/60
YT-83374	100	80x30x6	10/60
YT-83375	120	80x30x6	10/60
YT-83376	150	80x30x6	10/60

YATO	grit / ziarnistość	size / rozmiar (mm)	PCS
YT-83381	40	80x40x6	10/60
YT-83382	60	80x40x6	10/60
YT-83383	80	80x40x6	10/60
YT-83384	100	80x40x6	10/60
YT-83385	120	80x40x6	10/60
YT-83386	150	80x40x6	10/60

GB Flap wheel with shaft
D Fächerschleifmop mit Schaft
PL Ściernica listkowa trzpieniowa
RUS Круг лепестковый со шпинделем
CZ Lamelový kotouč s hřídelí
H Legyező csiszoló csapos

RO Perie abraziva circulara cu tija
F Disque à lamelles abrasives pivot
I Ruote lamellari
E Rueda laminar en tela abrasiva
CN 百叶轮



- application: metal
- abrasive: aluminium oxide
- bond: synthetic resin
- zastosowanie: metal
- ścierniwo: tlenek glinu
- spoiwo: żywica syntetyczna
- application: metal
- abrasive: aluminium oxide
- bond: synthetic resin
- zastosowanie: metal
- ścierniwo: tlenek glinu
- spoiwo: żywica syntetyczna
- application: metal
- abrasive: aluminium oxide
- bond: synthetic resin
- zastosowanie: metal
- ścierniwo: tlenek glinu
- spoiwo: żywica syntetyczna

YATO	grit / ziarnistość	size / rozmiar (mm)	
YT-83390	60	50x30x6	10/60
YT-83391	100	50x30x6	10/60
YT-83392	150	50x30x6	10/60
YT-83393	200	50x30x6	10/60

YATO	grit / ziarnistość	size / rozmiar (mm)	
YT-83394	60	60x50x6	10/60
YT-83395	100	60x50x6	10/60
YT-83396	150	60x50x6	10/60
YT-83397	200	60x50x6	10/60

YATO	grit / ziarnistość	size / rozmiar (mm)	
YT-83398	60	80x50x6	10/60
YT-83399	100	80x50x6	10/60
YT-83400	150	80x50x6	10/60
YT-83401	200	80x50x6	10/60

GB Abrasive disc
D Schleifpapier zum Gummiteiler
PL Krążek ścierny
RUS Круг шлифовальный
CZ Brusný kotouč
H Csiszolótárcsa
RO Disc abraziv
F Disques abrasifs avec velcro
I Disco abrasivo
E Juego de discos abrasivos
CN 圆形砂纸



GB Abrasive disc
D Schleifpapier zum Gummiteiler
PL Krążek ścierny
RUS Круг шлифовальный
CZ Brusný kotouč
H Csiszolótárcsa
RO Disc abraziv
F Disques abrasifs avec velcro
I Disco abrasivo
E Juego de discos abrasivos
CN 圆形砂纸

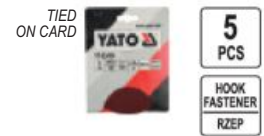

- application: metal, wood
- abrasive: aluminium oxide
- bond: synthetic resin
- backing: C
- coating: semi-open
- zastosowanie: metal, drewno
- ścierniwo: tlenek glinu
- spoiwo: żywica syntetyczna
- podkład: C
- nasyp półotwarty



- application: metal, wood
- abrasive: aluminium oxide
- bond: synthetic resin
- backing: C
- coating: semi-open
- zastosowanie: metal, drewno
- ścierniwo: tlenek glinu
- spoiwo: żywica syntetyczna
- podkład: C
- nasyp półotwarty

YATO	grit / ziarnistość	Ø (mm)	
YT-83420	36	115	50/200



YATO	grit / ziarnistość	Ø (mm)	
YT-83430	36	125	50/200
YT-83431	40	125	50/200
YT-83432	60	125	50/200
YT-83433	80	125	50/200
YT-83434	100	125	50/200
YT-83435	120	125	50/200
YT-83436	150	125	50/200
YT-83437	180	125	50/200
YT-83438	220	125	50/200

GB Abrasive disc with holes
D Schleifpapier zum Gummiteiler mit lochen
PL Krążek ścierny z otworami
RUS Круг шлифовальный перфорированный с липучкой
CZ Brusný kotouč z otvorami
H Fibertárcsa lyukakkal tépőzáras
RO Disc abraziv cu orificii
F Disques abrasifs trous avec velcro
I Disco abrasivo con fori
E Juego de discos abrasivos con agujeros
CN 圆形带孔砂纸



GB Abrasive disc with holes
D Schleifpapier zum Gummiteiler mit lochen
PL Krążek ścierny z otworami
RUS Круг шлифовальный перфорированный с липучкой
CZ Brusný kotouč z otvorami
H Fibertárcsa lyukakkal tépőzáras
RO Disc abraziv cu orificii
F Disques abrasifs trous avec velcro
I Disco abrasivo con fori
E Juego de discos abrasivos con agujeros
CN 圆形带孔砂纸

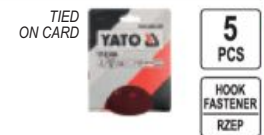

- application: metal, wood
- abrasive: aluminium oxide
- bond: synthetic resin
- backing: C
- coating: semi-open
- zastosowanie: metal, drewno
- ścierniwo: tlenek glinu
- spoiwo: żywica syntetyczna
- podkład: C
- nasyp półotwarty



- application: metal, wood
- abrasive: aluminium oxide
- bond: synthetic resin
- backing: C
- coating: semi-open
- zastosowanie: metal, drewno
- ścierniwo: tlenek glinu
- spoiwo: żywica syntetyczna
- podkład: C
- nasyp półotwarty

YATO	grit / ziarnistość	Ø (mm)	
YT-83440	36	115	50/200
YT-83441	40	115	50/200
YT-83442	60	115	50/200
YT-83443	80	115	50/200
YT-83444	100	115	50/200
YT-83445	120	115	50/200
YT-83446	150	115	50/200
YT-83447	180	115	50/200
YT-83448	220	115	50/200

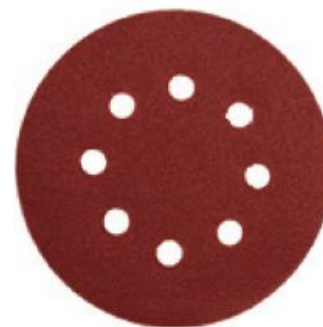

YATO	grit / ziarnistość	Ø (mm)	
YT-83451	40	125	50/200
YT-83452	60	125	50/200
YT-83453	80	125	50/200
YT-83454	100	125	50/200
YT-83455	120	125	50/200
YT-83456	150	125	50/200
YT-83457	180	125	50/200
YT-83458	220	125	50/200

GB Abrasive sheet with holes
D Schleifgewebe-scheiben mit lochen
PL Arkusz ścierny z otworami
RUS Шлифовальная перфорированная бумага для виброшлифмашинки
CZ Brusné archy z otvorami
H Csiszoló lap lyukakkal
RO Coale (foi) abrazive cu orificii
F Disques abrasifs trous avec velcro
I Disco abrasivo con fori
E Ojas abrasivas con agujeros
CN 方形带孔砂纸

TIED
ON CARD



5
PCS

HOOK
FASTENER
RZEP

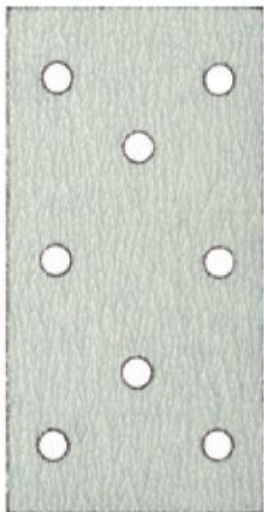

- application: paint, lacquer, filler
- abrasive: aluminium oxide
- bond: synthetic resin
- backing: C
- coating: semi-open
- zastosowanie: farby, lakiery, szpachle
- ścierniwo: tlenek glinu
- spoiwo: żywica syntetyczna
- podkład: C
- nasyp półotwarty

YATO	grit / ziarnistość	size / rozmiar (mm)	
YT-83480	40	93x180	25/100
YT-83481	60	93x180	25/100
YT-83482	80	93x180	25/100
YT-83483	100	93x180	25/100
YT-83484	120	93x180	25/100
YT-83485	150	93x180	50/200
YT-83486	180	93x180	50/200
YT-83487	220	93x180	50/200
YT-83488	240	93x180	50/200

GB Abrasive sheet with holes
D Schleifgewebe-scheiben mit lochen
PL Arkusz ścierny z otworami
RUS Шлифовальная перфорированная бумага для виброшлифмашинки
CZ Brusné archy z otvorami
H Csiszoló lap lyukakkal
RO Coale (foi) abrazive cu orificii
F Disques abrasifs trous avec velcro
I Disco abrasivo con fori
E Ojas abrasivas con agujeros
CN 方形带孔砂纸

TIED
ON CARD



5
PCS



- application: metal, wood
- abrasive: aluminium oxide
- bond: synthetic resin
- backing: C
- coating: semi-open
- zastosowanie: metal, drewno
- ścierniwo: tlenek glinu
- spoiwo: żywica syntetyczna
- podkład: C
- nasyp półotwarty

YATO	grit / ziarnistość	size / rozmiar (mm)	
YT-83490	40	93x230	25/100
YT-83491	60	93x230	25/100
YT-83492	80	93x230	25/100
YT-83493	100	93x230	25/100
YT-83494	120	93x230	25/100
YT-83495	150	93x230	25/100
YT-83496	180	93x230	25/100
YT-83497	220	93x230	25/100
YT-83498	240	93x230	25/100

10

Memo

11

Hydraulic tools Narzędzia hydrauliczne



Ratchet die stock sets
Gwintownice ręczne z zestawem głowic

204



Calibrators
Kalibratory

209



Accessories for ratchet die stock
Akcesoria do gwintownic ręcznych

204



Burners & soldering tools
Palniki i lutownice

210-211



Pipe wrenches
Klucze do rur

204-205



Pipe welders
Zgrzewarki do rur

211



Strap wrenches
Klucze do rur taśmowe

205



Pipe crimping pliers & accessories
Zaciskarki do rur i akcesoria

211



Chain pipe wrenches
Klucze do rur łańcuchowe

206



Hinged pipe vices
Imadła zaciskowe do rur

212



Water pump pliers
Szczypce nastawne

206



Thread seal strings
Nici do uszczelniania gwintów

212



Step wrenches
Klucze sztorcowe

206



Deburrers & accessories
Gratowniki i akcesoria

212



Pipe cutters
Obcinaki do rur

207-208



Pipe brushes
Szczotki do rur

213



Pipe benders
Giętarki do rur

209



Cleaning pads for pipes
Włókniny do czyszczenia rur

213



Hand flaring tools sets
Praski do rozszerzania rur

209



Tool boxes & tools in PVC trays
Skrzynki narzędziowe i zestawy narzędzi do szuflad

213-215



- GB Ratchet die stocks
 D Rohrgewinde-schneidsatz
 PL Gwintownica z zestawem glowic
 RUS Набор плашек
 CZ Sada závitníků
 H Menetfűró készlet
- RO Trusa filiere
 F Taraud manuel
 I Filiera per tubi a mano
 E Juego de roscar
 CN 管子铰板组套

BMC & COLOR SLEEVE



9Cr2



5 PCS	3/8" 10mm	1/2" 12.5mm	3/4" 19mm	1" 25mm
----------	--------------	----------------	--------------	------------

7 PCS	1/4" 6.3mm	3/8" 10mm	1/2" 12.5mm	3/4" 19mm	1" 25mm	5/4" 32mm
----------	---------------	--------------	----------------	--------------	------------	--------------

YATO	size / rozmiar	
YT-29001	3/8" (10.0 mm); 1/2" (12.5 mm); 3/4" (19.0 mm); 1" (25.0 mm)	4

YATO	size / rozmiar	
YT-2900	1/4" (6.3 mm); 3/8" (10.0 mm); 1/2" (12.5 mm); 3/4" (19.0 mm); 1" (25.0 mm); 5/4" (32.0 mm)	4

- GB Spare knives for ratchet die stock
 D Rohrgewinde-Schneidbacken
 PL Noże zapasowe do gwintownicy ręcznej
 RUS Запасные ножи дляправки трубинной резьбы
 CZ Náhradní nože do ručního závitofež
 H Tartalék kések, racsnis csőmenetvágóhoz
- RO Cutit de rezerva pt. filiera
 F Lame pour taraud à main
 I Lame di ricambio per filettatrici manuale
 E Filos de recambio para terraja de mano
 CN 板牙

4
PCS
9Cr2



POLYBAG WITH HEADER

YATO	size / rozmiar	PCS packing	
YT-2910	1/4" (6.3 mm)	4	50/200
YT-2911	3/8" (10.0 mm)	4	50/200
YT-2912	1/2" (12.5 mm)	4	50/200
YT-2913	3/4" (19.0 mm)	4	50/200
YT-2914	1" (25.0 mm)	4	50/200

- GB Spare head for ratchet die stock
 D Rohrgewinde-Schneidköpfe
 PL Glowica zapasowa do gwintownicy ręcznej
 RUS Запасная оправка для нарезания трубинной резьбы
 CZ Náhradní hlava pro ruční závitofež
 RO Cap de rezerva pt. placa filetat cu clichet
 F Mandrin porte-taraud
 I Testina ricambio per filettatrici manuale
 E Cabeza de recambio para terraja de mano
 CN 板牙头



9Cr2

COLOR BOX

YATO	size / rozmiar	
YT-2916	1/4" (6.3 mm)	10/40
YT-2917	3/8" (10.0 mm)	10/40
YT-2918	1/2" (12.5 mm)	10/40
YT-2919	3/4" (19.0 mm)	10/40
YT-2920	1" (25.0 mm)	10/40
YT-2921	5/4" (32.0 mm)	10/40

- GB Pipe wrench
 D Rohrschlüssel
 PL Klucz do rur
- RUS Ключ трубный
 CZ Klíč součásti na trubky
 H Csőkulcs
- RO Cheie reglabila pt. tevi
 F Clé aux tubes
 I Chiave per tubi
- E Llave para tubos
 CN 铝合金管钳

CrMo

HRC 55-60

Al HANDLE UCHWYT



YATO	size / rozmiar	max. pipe diameter / max. średnica rury	
YT-2482	14" (350 mm)	2" (50 mm)	6/12
YT-2483	18" (450 mm)	2.5" (63 mm)	2/10
YT-2484	24" (600 mm)	3" (75 mm)	2/6
YT-2485	36" (900 mm)	5" (125 mm)	3

HRC 55-60

Al HANDLE UCHWYT



YATO	size / rozmiar	max. pipe diameter / max. średnica rury	
YT-2222	12" (300 mm)	1" (25 mm)	6/24
YT-2223	14" (350 mm)	1.5" (38 mm)	4/16
YT-2224	18" (450 mm)	2" (50 mm)	3/12
YT-2225	24" (600 mm)	2.5" (63 mm)	3/6

HRC 55-60

OFFSET TYPE ODGIĘTA GŁOWICA



YATO	size / rozmiar	max. pipe diameter / max. średnica rury	
YT-2201	10" (250 mm)	1" (25 mm)	6/36
YT-2203	14" (350 mm)	1.5" (38 mm)	4/16
YT-2204	18" (450 mm)	2" (50 mm)	3/12
YT-2205	24" (600 mm)	2.5" (63 mm)	3/6
YT-2206	36" (900 mm)	4" (100 mm)	2/4

CrMo

HRC 55-60



YATO	size / rozmiar	max. pipe diameter / max. średnica rury	
YT-2488	10" (250 mm)	1" (25 mm)	6/18
YT-2489	12" (300 mm)	1.5" (38 mm)	6/12
YT-2490	14" (350 mm)	2" (50 mm)	2/10
YT-2491	18" (450 mm)	2.5" (63 mm)	3/6
YT-2492	24" (600 mm)	3" (75 mm)	2/4
YT-2493	36" (900 mm)	5" (125 mm)	1
YT-2494	48" (1200 mm)	6" (150 mm)	1

GB Adjustable pipe wrench
D Rohrschlüssel
PL Klucz nastawny do rur
RUS Ключ трубный переставной

CZ Nastavitelný klíč na trubky
H Állítható csőkulcs
RO Cheie reglabilă pt. țevi
F Clé serre-tube „suédois”

I Pinze regolabili per tubi
E Llave para tubos tipo Inglesa
CN 鷹嘴鉗

COLOR BOX



90°	1"	1.5"	2"
	25 mm	38 mm	50 mm
DIN 5234		CrV 6140	

YATO	max. pipe diameter / max. średnica rury	L (mm)	
YT-2210	1" (25 mm)	320	24
YT-2211	1.5" (38 mm)	420	18
YT-2212	2" (50 mm)	560	12

GB Adjustable pipe wrench
D Rohrschlüssel
PL Klucz nastawny do rur
RUS Ключ трубный переставной

CZ Nastavitelný klíč na trubky
H Állítható csőkulcs
RO Cheie reglabilă pt. țevi
F Clé serre-tube „suédois”

I Pinze regolabili per tubi
E Llave para tubos tipo Inglesa
CN 鷹嘴鉗

COLOR BOX



45°	1"	1.5"	2"
	25 mm	38 mm	50 mm
DIN 5234		CrV 6140	

YATO	max. pipe diameter / max. średnica rury	L (mm)	
YT-2213	1" (25 mm)	330	24
YT-2214	1.5" (38 mm)	415	18
YT-2215	2" (50 mm)	530	12

GB Adjustable pipe wrench
D Rohrschlüssel
PL Klucz nastawny do rur
RUS Ключ трубный переставной

CZ Nastavitelný klíč na trubky
H Állítható csőkulcs
RO Cheie reglabilă pt. țevi
F Clé serre-tube „suédois”

I Pinze regolabili per tubi
E Llave para tubos tipo Inglesa
CN 鷹嘴鉗

COLOR BOX



S	1"	1.5"	2"
	25 mm	38 mm	50 mm
DIN 5234		CrV 6140	

YATO	max. pipe diameter / max. średnica rury	L (mm)	
YT-2216	1" (25 mm)	330	24
YT-2217	1.5" (38 mm)	420	18
YT-2218	2" (50 mm)	535	12

GB Auto-adjustable pipe wrench
D Rollgabelschlüssel
PL Szybkonastawny klucz do rur
RUS Ключ разводной
CZ Nastavitelný klíč
H Állítható svédkulcs

RO Cheie reglabilă
F Clé á molette
I Chiave autoregolabile per tubi
E Llave ajustable
CN 可调式管钳

16-38 mm
5/8"-1 1/2"
300 mm
SELF-ADJUSTING SAMO-NASTAWNY
QUICK RELEASE SZYBKIE OTWIERANIE
HRC 46-52
HARDENED JAWS HARTOWANE SZCZĘKI

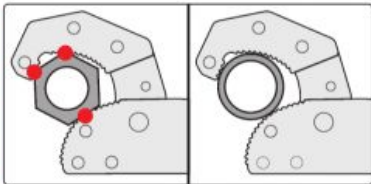

HALF DOUBLE BLISTER

YATO	L (mm)	
YT-22005	300	6/24

GB Strap wrench
D Bandschlüssel
PL Klucz taśmowy do rur
RUS Стрчковый ключ
CZ Klíč s popruhem
H Csőfogó

RO Cheie cu chinga
F Clé a sangle sanitaire
I Chiave a nastro per tubi
E Llave de correa
CN 皮带管钳

300 mm
12"
200 mm
8"
STRAP SIZE WYMIAR PASMA 825 x 28 mm
NYLON AI



for:
• chromed pipes
• PVC pipes
• oil filters

do:
• rur chromowanych
• rur PCV
• filtrów oleju



SLIDING CARD

YATO	L (mm)	max. pipe diameter / max. średnica rury	
YT-22255	300	8" (200 mm)	5/50

GB Pipe wrench - german type
D Rohrschlüssel - deutsch type
PL Klucz do rur - typ niemiecki
RUS Трубный ключ - немецкий тип
CZ Nastavitelný klíč na trubky - němčina typ

H Állítható csőkulcs - német típusú
RO Cheie reglabilă pt. țevi - tip german
F Clé serre-tube type allemand
I Chiave per tubi - tipo tedesco
E Llave para tubos tipo alemán
CN 德式管子鉗

HRC 47-53
HARDENED JAWS HARTOWANE SZCZĘKI



COLOR BOX

YATO	L (mm)	max. opening capacity / max. zakres rozwarcia szczęk (mm)	max. pipe diameter / max. średnica rury (mm)	
YT-22000	7" (175 mm)	45	20	6/60
YT-22001	9" (225 mm)	60	30	6/36
YT-22002	10.5" (275 mm)	70	35	6/24

GB Strap for pipe wrench
D Gurt für Bandschlüssel
PL Taśma zapasowa do klucza do rur
RUS Ремень для ремешковые ключи
CZ Popruh pro klíče olejových filtrů

H Szíjas az szíjas csőfogó
RO Chinga la cheie cu chingă
F Courroie pour clés a courroie
I Nastro di ricambio per chiave per tubi
E Correa a laves de correa
CN 皮带管钳配件

200 mm
8"
STRAP SIZE WYMIAR PASMA 825 x 28 mm
NYLON



for / dla: YT-22255

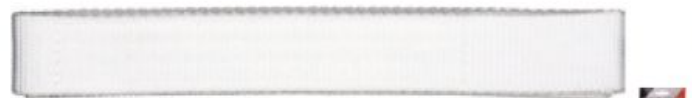

for:
• chromed pipes
• PVC pipes
• oil filters

do:
• rur chromowanych
• rur PCV
• filtrów oleju

POLYBAG WITH HEADER

YATO	L (mm)	
YT-22256		50

- GB Chain pipe wrench
- D Kettenrohrzange
- PL Klucz łańcuchowy do rur
- RUS Ключ цепной для труб
- CZ Klíč řetězový na trubky
- H Láncos csőfogó
- RO Cheie reglabila pt. tevi cu lant
- F Clé à chaîne
- I Chiave a catena per tubi
- E Llave de cadena
- CN 链条管子钳



SLIDING CARD

4" 300 mm

INDUCTION HARDENED TEETH

ADJUSTABLE WORKING RANGE

STEEL HARDENED INDUSTRY GRADE

REGUL. CRIMPLY ZÁVĚSÍ PRACÍ

YATO	L (mm)	max. pipe diameter / max. średnica rury	
YT-22260	300	4" (100 mm)	6/24

- GB Water pump pliers
- D Wasserpumpenzange
- PL Szczypce nastawne
- RUS Клещи переставные
- CZ Keleště siko
- H Vizpumpafagó
- RO Cleste papagal
- F Pince réglable
- I Pinze regolabili
- E Alicates de fontanero ajustables
- CN 水泵钳

250 mm 300 mm CrV

WORKING RANGE ADJUSTMENT REGULACJA ZAKRESU PRACY

STRENGTHENED JAWS WZMOCNIENIA KŁOPIECY



YATO	L (mm)	
YT-2090	250	6/36
YT-2091	300	6/36

- GB Water pump pliers
- D Wasserpumpenzange
- PL Szczypce nastawne
- RUS Клещи переставные
- CZ Keleště siko
- H Vizpumpafagó
- RO Cleste papagal
- F Pince réglable
- I Pinze regolabili
- E Alicates de fontanero ajustables
- CN 水泵钳

250 mm 6 mm CrV

JAW WIDTH SZEROKOŚĆ KŁOPIECY 6 mm

WORKING RANGE ADJUSTMENT REGULACJA ZAKRESU PRACY

STRENGTHENED JAWS WZMOCNIENIA KŁOPIECY



YATO	L (mm)	
YT-20911	250	10/50

- GB Water pump pliers
- D Wasserpumpenzange
- PL Szczypce nastawne
- RUS Клещи переставные
- CZ Keleště siko
- H Vizpumpafagó
- RO Cleste papagal
- F Pince réglable
- I Pinze regolabili
- E Alicates de fontanero ajustables
- CN 水泵钳

HALF DOUBLE BLISTER

250 mm

NICKEL IRON FINISH



YATO	L (mm)	
YT-2069	250	6/36

- GB Water pump pliers
- D Wasserpumpenzange
- PL Szczypce nastawne
- RUS Клещи переставные
- CZ Keleště siko
- H Vizpumpafagó
- RO Cleste papagal
- F Pince réglable
- I Pinze regolabili
- E Alicates de fontanero ajustables
- CN 水泵钳



250 mm CrV 1000 V DVE

1000V VDE CERTIFICATE EN 60900:2012

HALF DOUBLE BLISTER

YATO	L (mm)	
YT-21161	250	6/24

- GB Internal ratchet wrench
- D Innenratschenschlüssel
- PL Grzechotka wewnętrzna
- RUS Трещотка внутренняя
- CZ Radiátorový klíč s ráčnou
- H Lépcsős kulcskészlet
- racsnival
- RO Cheie robinet radiator
- F Clé de montage étagée
- I Cricchetto di tipo interno
- E Llave carraca radiadores
- CN 穿心棘轮扳手

1/2" 12.5 mm CrV 30T



for / dla: YT-03316

TIED ON CARD

YATO		
YT-03315	1/2" (12.7 mm)	6/24

- GB Step wrench
- D Stufenschlüssel
- PL Klucz stopniowy
- RUS Калибратор FORA для металлопластиковых труб
- CZ Klíč na radiátorové šroubení
- H Lépcsős radiátor kulcs
- RO Cheie in trepte pt. radiator
- F Clé de montage étagée
- I Chiave a cricco
- E Llave de radiadores
- CN 散熱六角階梯扳手

1/2" 12.5 mm 3/8" 29/68" 1/2" 21/32" 27/32"

9.6 mm 11.6 mm 12.6 mm 16.4 mm 21 mm

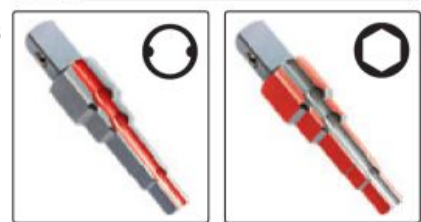

for / dla: YT-03315

POLYBAG WITH HEADER

YATO		
YT-03316	1/2" (12.7 mm)	100

- GB PVC pipe cutter
D PVC Rohrabsschneider
PL Obcinak do rur PCV
RUS Труборез для ПВХ труб
CZ Řezač PVC trubek
H Csővágó olló PVC csövekhez
RO Clește pt. tăiat țevi din PVC
F Coupeur aux tubes
I Taglia tubi PVC
E Cortatubos PVC
CN PVC 管子割刀



max (mm) **35** PEX AL PEX PVC PP PU PE 8Cr13 STAINLESS STEEL STAL NIERDZEWNA HRC 54

SLIDING CARD

YATO	max. Ø (mm)	
YT-2230	35	6/48

- GB PVC pipe cutter
D PVC Rohrabsschneider
PL Obcinak do rur PCV
RUS Труборез для ПВХ труб
CZ Řezač PVC trubek
H Csővágó olló PVC csövekhez
RO Clește pt. tăiat țevi din PVC
F Coupeur aux tubes
I Taglia tubi PVC
E Cortatubos PVC
CN PVC 管子割刀



max (mm) **42** PEX AL PEX PVC PP PU PE 8Cr13 STAINLESS STEEL STAL NIERDZEWNA HRC 54 RATCHET SYSTEM ZAPADKOWY QUICK RELEASE SZYBKIE ZWALNIANIE

SLIDING CARD

YATO	max. Ø (mm)	
YT-2231	42	6/48

- GB PVC pipe cutter
D PVC Rohrabsschneider
PL Obcinak do rur PCV
RUS Труборез для ПВХ труб
CZ Řezač PVC trubek
H Csővágó olló PVC csövekhez
RO Clește pt. tăiat țevi din PVC
F Coupeur aux tubes
I Taglia tubi PVC
E Cortatubos PVC
CN PVC 管子割刀



max (mm) **63** PEX AL PEX PVC PP PU PE 8Cr13 STAINLESS STEEL STAL NIERDZEWNA HRC 56-58 RATCHET SYSTEM ZAPADKOWY QUICK RELEASE SZYBKIE ZWALNIANIE

SLIDING CARD

YATO	max. Ø (mm)	
YT-22312	63	6/24

- GB PVC pipe cutter
D PVC Rohrabsschneider
PL Obcinak do rur PCV
RUS Труборез для ПВХ труб
CZ Řezač PVC trubek
H Csővágó olló PVC csövekhez
RO Clește pt. tăiat țevi din PVC
F Coupeur aux tubes
I Taglia tubi PVC
E Cortatubos PVC
CN PVC 管子割刀



SLIDING CARD

PEX AL PEX PVC PP PU PE 8Cr13 STAINLESS STEEL STAL NIERDZEWNA HRC 54 AI RATCHET SYSTEM ZAPADKOWY QUICK RELEASE SZYBKIE ZWALNIANIE

max (mm) **51**

YATO	max. Ø (mm)	
YT-2228	51	6/24



max (mm) **64**

YATO	max. Ø (mm)	
YT-2229	64	6/24

- GB Pipe cutter
D Rohrabsschneider
PL Obcinak do rur
RUS Труборез для труб
CZ Řezač trubek
H Csővágó olló csövekhez
RO Clește pt. tăiat țevi
F Coupeurs aux tubes
I Rullo di taglio per tubi
E Cortatubos
CN 管子割刀

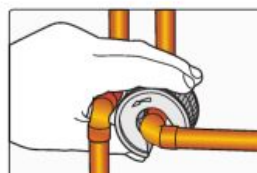

PEX PLASTIC Al, Cu BEARING STEEL STAL CIERNYKWA

SLIDING CARD

YATO	Ø	external diameter / średnica zewnętrzna (mm)	
YT-22353	19/32" (15 mm)	48	5/50
YT-22354	23/32" (18 mm)	59	10/50
YT-22355	7/8" (22 mm)	56	10/50

GB Pipe cutter CZ Řezač trubek F Coupeur aux tubes
 D Rohrschneider H Csővágó olló I Taglia tubi PVC
 PL Obcinak do rur RO Clește pt. tăiat țevi E Cortatubos
 RUS Труборіз для труб CN 管子割刀

COLOR BOX



PEX



PLASTIC Al, Cu
 Ø 1/10"-7/8"
 Ø 3-22 mm



YATO	Ø	
YT-22318	1/10"-7/8" (3-22 mm)	100



PLASTIC Al, Cu
 Ø 1/10"-5/4"
 Ø 3-32 mm

QUICK-ADJUSTMENT
 SZYBKONASTAWNY

WITH DEBURRER
 Z GRATOWNIKIEM



YATO	Ø	
YT-22338	1/10"-5/4" (3-32 mm)	50



PLASTIC Al, Cu
 Ø 3/8"-1-5/8"
 Ø 10-40 mm



YATO	Ø	
YT-2232	3/8"-1-5/8" (10-40 mm)	20



PLASTIC Al, Cu
 Ø 1/4"-7/4"
 Ø 6-45 mm

WITH DEBURRER
 Z GRATOWNIKIEM



YATO	Ø	
YT-2233	1/4"-7/4" (6-45 mm)	25



PLASTIC Al, Cu
 Ø 1/2"-5/2"
 Ø 14-63 mm



QUICK-ADJUSTMENT
 SZYBKONASTAWNY



YATO	Ø	
YT-2234	1/2"-5/2" (14-63 mm)	25



PLASTIC Al, Cu
 Ø 2"-5"
 Ø 50-127 mm

QUICK-ADJUSTMENT
 SZYBKONASTAWNY



YATO	Ø	
YT-2235	2"-5" (50-127 mm)	10

GB Replacement cutting wheel for pipe cutters
 D Ersatzschneidrad für Rohrschneider
 PL Zapasowe kółko tnące do obcinaka do rur
 RUS Запасной режущий диск для труборезов
 CZ Náhradní řezné kolečko na trubky frézy

H Tartalék vágókerék cső vágó
 RO Roata de schimb pt. taiere țevi
 F Molette pour coupe
 I Taglio ruote tubo taglierina
 E Rueda de corte de repuesto para cortatubos
 CN 管子割刀刀片

2 PCS



DOUBLE BLISTER

YATO	a (mm)	b (mm)	c (mm)	for/dla:	
YT-22313	18	6	4.8	YT-2233	50/300
YT-22314	26	14	7.5	YT-2232	6/108
YT-22315	18	6	4.8	YT-22338	50/300
YT-22316	27	6.3	5	YT-2234	24/288

GB Replacement cutting wheel for pipe cutters
 D Ersatzschneidrad für Rohrschneider
 PL Zapasowe kółko tnące do obcinaka do rur
 RUS Запасной режущий диск для труборезов
 CZ Náhradní řezné kolečko na trubky frézy

H Tartalék vágókerék cső vágó
 RO Roata de schimb pt. taiere țevi
 F Molette pour coupe
 I Taglio ruote tubo taglierina
 E Rueda de corte de repuesto para cortatubos
 CN 管子割刀刀片

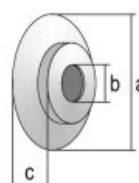

DOUBLE BLISTER

YATO	a (mm)	b (mm)	c (mm)	for/dla:	
YT-22317	44	10.6	8	YT-2235	12/144

GB Standard two handed bender
D Standard-Zweihand-Bieger
PL Giętarka do rur
RUS Стандартный двуручный трубогиб

CZ Standardní dvouruční ohýbačka
H Kétkezéses hajlító
RO Dispozitiv de indoit teava
F Cintreuse aux tubes

I Tubo manuale bender
E Curvadoras manuales de tubos
CN 弯管器

180°
Al, Cu
SOFT STEEL
MIEKKA STAL
COPPER
MOBIADZ

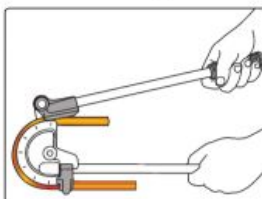
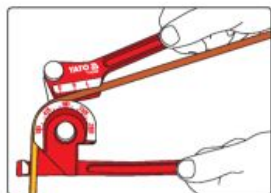

WHITE
CARTON BOX
& COLOR LABEL

YATO	∅	
YT-21840	1/4" (6.3 mm); 5/16" (8 mm); 3/8" (10 mm)	20

YATO	∅	
YT-21842	15/32" (12 mm)	20
YT-21843	9/16" (14 mm)	10
YT-21844	9/32" (15 mm)	10
YT-21845	5/8" (16 mm)	10
YT-21846	23/32" (18 mm)	10

GB Internal pipe bending spring
D Innen-Rohrbiegefeder
PL Sprężyna wewnętrzna do gięcia rur
RUS Пружина для изгиба металлопластиковых труб, внутренняя
CZ Pružina pro ohýbání trubek vnitřní

H Belső cső hajlító rugó
RO Arc indoire pt. tevi flexibile
F Ressort de cintrage intérieur
I Curvatubi molla interna
E Muelle curvado interior para tubo
CN 倪奪葉銅

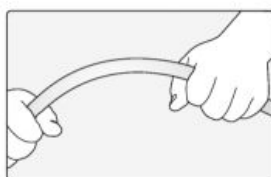

TIED
ON CARD



YATO	external pipe diameter / zewnętrzna średnica rury (mm)	
YT-21850	16	25
YT-21851	20	25
YT-21852	25-26	25

11

GB Hand flaring tools set
D Handpresse zum Aufweiten von Rohren
PL Praska do ręcznego rozszerzania rur
RUS Пресс для ручного расширения труб

CZ Přípravek na ruční rozšiřování konců trubek
H Kézi csőtágító
RO Presă manuală pt. lățirea țevilor
F Set pour étendre les tubes

I Presa per tubi
E Prensa para la elongación manual de tubos
CN 扩孔器套装

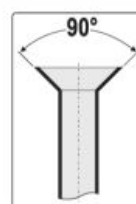

COLOR BOX



BMC & COLOR SLEEVE



2
PCS

7
PCS

YATO	∅ (mm)	
YT-2182	22; 25; 28	20

YATO	∅ (mm)	
YT-2180	3; 5; 6; 8; 10; 12; 14; 15; 16; 19	10

GB Pipe calibration tool with reamer
D Kalibrierer mit Entgrater für Mehrschichtverbundrohr
PL Kalibrator z gratownikiem
RUS Калибратор пластиковый с фаскоснимателем
CZ Kalibrator na trubky
H Ótrétegű cső kalibráló
RO Calibrator teava multistrat
F Calibreur ébavureur intérieur de tubes multicouches
I Calibratore tubo con deburrer
E Calibrador para tubos multicapa
CN 内外倒角整圆器

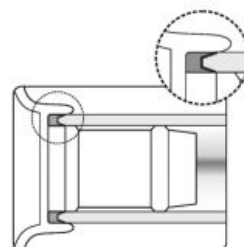

PEX AL PEX
WITH DEBURRER
Z GRATOWNIKIEM

TIED
ON CARD



YATO	pipe diameter / średnica rury (mm)	
YT-22373	16; 20; 25	200
YT-22374	16; 20; 26	200

- GB Gas torch
- D Gasbrenner
- PL Palnik gazowy
- RUS Газовая паяльная лампа
- CZ Plynový hořák
- H Gázégő
- RO Arzător de gaz
- F Bruleur à gaz
- I Saldatore bruciatore a gas
- E Soplete de gas
- CN 火焰枪



PIEZO	30 ml	60-90 min	GAS GAZ
LOCK BLOKADA	BUTANE lighter gas BUTAN (gas de aprindere)	CHILD PROTECTION (ZABRANJEN PRISTUP DECIJAM)	



1300°C

YATO	
YT-36700	10/20

DOUBLE BLISTER



- GB Soldering tool set
- D Gaslötkolben satz
- PL Lutownica gazowa z akcesoriami
- RUS Газовый паяльный набор
- CZ Plynova pajka souprava
- H Gaz forrasztópaka készletek
- RO Set ciocan de lipit cu gaz
- F Fer à souder à gaz
- I Saldatore a gas
- E Soldador a gas con accesorios
- CN 自动点火多功能瓦斯组套

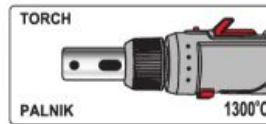
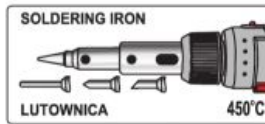

7 PCS	30-125 W	30 ml	75 min
GAS GAZ	PIEZO	LOCK BLOKADA	BUTANE lighter gas BUTAN (gas de aprindere)
PROPANE-BUTANE lighter gas PROPAN-BUTAN (gas de aprindere)	CHILD PROTECTION (ZABRANJEN PRISTUP DECIJAM)		

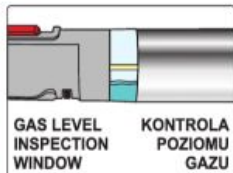

GAS LEVEL INSPECTION WINDOW
KONTROLA POZIOMU GAZU

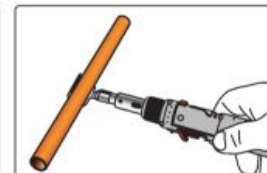

PLASTIC BOX & HANGING COLOR BOX

YATO	W
YT-36706	30-125 6

- GB Soldering tool 3 in 1
- D Gaslötkolben 3 in 1
- PL Lutownica gazowa 3 w 1
- RUS Газовый паяльник 3-в-1
- CZ Plynova pajka 3 in 1
- H Gaz-forrasztópaka 3 in 1
- RO Ciocan de lipit cu gaz 3 in 1
- F Fer à souder à gaz
- I Saldatore a gas
- E Soldador de gas 3 in 1
- CN 瓦斯焊接工具



PIEZO	30~70 W	12 ml	60 min	GAS GAZ
LOCK BLOKADA	BUTANE lighter gas BUTAN (gas de aprindere)	PROPANE-BUTANE lighter gas PROPAN-BUTAN (gas de aprindere)	CHILD PROTECTION (ZABRANJEN PRISTUP DECIJAM)	

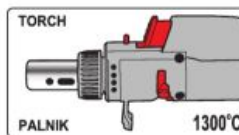
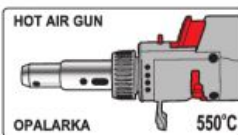
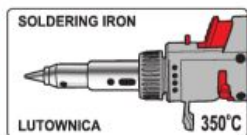

GAS LEVEL INSPECTION WINDOW
KONTROLA POZIOMU GAZU

SLIDING CARD

YATO	W
YT-36704	30-70 12/72

- GB Gas blow torch
- D Lötbrenner
- PL Palnik gazowy
- RUS Газовая горелка
- CZ Plynový hořák
- H Gázégő
- RO Arzător de gaz
- F Bruleur à gaz
- I Saldatore bruciatore a gas
- E Soplete de gas
- CN 火焰枪

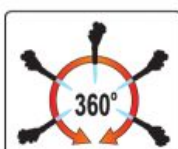

PIEZO	1.0 kW	73 g/h	GAS GAZ	BUTANE BUTAN
-------	--------	--------	---------	--------------

SLIDING CARD

YATO	kW
YT-36710	1.0 10/100

GB Gas blow torch
D Lötbrenner
PL Palnik gazowy
RUS Газовая горелка

CZ Plynový hořák
H Gázégő
RO Arzător de gaz
F Bruleur à gaz

I Saldatore bruciatore a gas
E Soplete de gas
CN 火焰枪

PIEZO 1.28 kW GAS GAZ AIR POWIETRZE LOCK BLOKADA BUTANE BUTAN

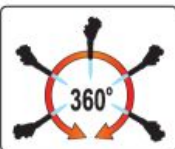

YATO kW 1.28 6/12

GB Turbo gas torch
D Turbo-Handbrenner
PL Palnik gazowy turbo
RUS Газовая горелка турбо
CZ Plynový hořák turbo
H Kézi gázégő
RO Arzător cu gaz turbo
F Bruleur à gaz turbo
I Saldatore bruciatore a gas
E Quemador de gas turbo
CN 手持式焊枪



PIEZO 2800°C 2.0 kW 142 g/h 2.59 MPa G1" F PROPAN GAS GAZ AUTO START STOP LOCK BLOKADA CONTINUOUS BURN LOCK BLOKADA PRACY GAZEM TURBO NOZZLE DYŹKA TURBO



YATO kW 2.0 20

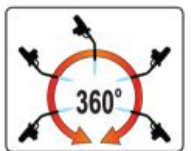

GB PVC plastic pipe welder
D Schweissgerät für thermoplastische Rohre
PL Zgrzewarka do rur termoplastycznych
RUS Сварочная машина для термопластиковых труб
CZ Svářečka na termoplastické trubky
H Hegesztő berendezés termoplasztikus csövekhez
RO Masina de sudat tevi termoplastice
F Soudeur en tuyauterie en PVC
I Polifusore saldatore per tubi
E Maquina de soldar las tubos termoplasticos
CN 热熔器



230V~50Hz 850 W 0-300°C Ø 16, 20, 25, 32 [mm] 40, 50, 63



YATO W 850 2

GB Crimping pliers for PEX-AL-PEX pipes
D Crimpzange für die Verbindungen an den Röhren
PL Praska do zaciskania złączek PEX-AL-PEX
RUS Пресс-клещи для металлопластиковых труб
CZ Lisovacé kleště pro trubky PEX-AL-PEX
H PEX-AL-PEX krimpelő eszköz
RO Clește de sertizare pt. țevi PEX-AL-PEX
F Pince des joints de raccordement des tuyaux PEX-AL-PEX
I Pressa pex tubo di piegatura
E Crimpadora para los tubos PEX-AL-PEX
CN 液压管钳

9 PCS PE-RT AL PE-RT PEX AL PEX U 16mm U 20mm U 25mm U 32mm 6t ≈60kN TH 16mm TH 20mm TH 26mm TH 32mm

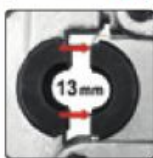

YATO 57-80 cm 2

GB Spare die for crimping pliers
 D Ersatz Matrize für Presswerkzeug
 PL Matryca zapasowa do zaciskarki
 RUS Вкладыши для пресс-инструмента
 CZ Vyměnné čelisti
 H Présfogók
 RO Capete de presare pt. inele interschimbabile

F Matrices empreinte pour pince
 I Dies ricambo
 E Que prensa de troquel para crimpadora
 CN 压管模块



POLYBAG WITH HEADER
 PE-RT AL PE-RT
 PEX AL PEX

GB Hinged pipe vice
 D Rohrschraubstock
 PL Imadło zaciskowe do rur
 RUS Тиски для труб
 CZ Upinací svěrák na trubky
 H Satu, csőszorító
 RO Menghină pt. țevi
 F Étau de serrage à tuyaux
 I Morsa stringi tubo
 E Tornillo de apriete para tubos
 CN 管子台虎钳



S55C



for / dla: YT-21735

U	YATO	size / rozmiar U (mm)	
	YT-21740	16	50
	YT-21741	20	100
	YT-21742	25	100
	YT-21743	32	100



for / dla: YT-21735

TH	YATO	size / rozmiar TH (mm)	
	YT-21744	16	50
	YT-21745	20	50
	YT-21746	26	100
	YT-21747	32	100

YATO	Ø (mm)	
YT-6510	60	4
YT-6511	76	2
YT-6512	90	2
YT-6513	110	1

GB Thread seal string
 D Gewindedichtfaden
 PL Nić do uszczelniania gwintów
 RUS Уплотнительная нить
 CZ Těsnící vlákno na závit
 H Menettömítő zsinór
 RO Snur de etansare conducte si filete
 F Tuyau étanchéité cordon
 I Filo sigillafletti
 E Hilo sellador
 CN 螺纹密封胶线

PIPE DIAMETER / ŚREDNICA RURY	CYCLE NUMBER / ILOŚĆ ZWOJÓW
1/2" (12.5 mm)	6~8
3/4" (19 mm)	7~9
1" (25 mm)	8~12
1 1/2" (38 mm)	10~15
2" (50 mm)	15~25
2 1/2" (63 mm)	20~35
3" (75 mm)	25~35
3 1/2" (88 mm)	30~40
4" (100 mm)	35~45

PLASTIC BOX

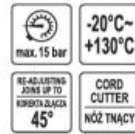

11



50m EFFICIENCY WYDAJNOŚĆ 50m x 11x12"

YATO	L (mm)	
YT-29220	50	25/100

150m EFFICIENCY WYDAJNOŚĆ 150m x 13x12"



YATO	L (mm)	
YT-29222	150	25/100

GB Universal quick deburrer
 D Universal-Schnell-Entgrater
 PL Gratownik
 RUS Универсальный быстро гратосниматель
 CZ Univerzální rychlé odhrotování
 H Univerzális gyors sorjátlanító
 RO Debavurator rapid universal
 F Ébavureur
 I Utensile di sbavatura
 E Desbarbador rápida universal
 CN 去毛刺修边器

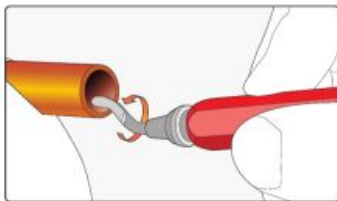

YATO	
YT-22360	50/150

HSS M2 BODY KORPUS Ø12mm

SLIDING CARD

GB Replacement blade for deburrer
 D Ersatzklinge für Entgrater
 PL Ostrza zapasowe do gratownika
 RUS Лезвие для снятия заусенцев
 CZ Náhradní čepel pro odjehlování
 H Tartalék penge sorjázásához
 RO Cutit de schimb pt. debavurare
 F Set le lames pour ébavureur
 I Set di lame per sbavatura utensile
 E Cuchilla de repuesto para desbarbar
 CN 修边器刀片

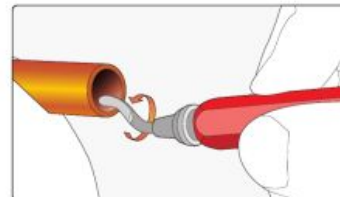

10 PCS HSS M2 UNIVERSAL SHAPE UNIVERZÁLNY KSZTÁLT



for / dla: YT-22360

YATO	
YT-22361	12/144

SLIDING CARD

- GB Copper pipe internal brush
D Kupferrohr Innenbürste
PL Szczotka wewnętrzna do rur miedzianych
RUS Щетка для внутренней очистки труб
CZ Kartač vnitřní na měděné trubky
H Rézcső belső tisztító kefe
RO Perii de interior pt. tevi de cupru

- F Brosse aux tubes en cuivre
I Spazzola per il rame interno
E Cepillo para limpieza de tubos de cobre
CN 管子刷



YATO	internal pipe diameter / wewnętrzna średnica rury (mm)	
YT-63701	15	12/120
YT-63702	18	12/120
YT-63703	22	12/120
YT-63704	28	12/120

- GB Copper pipe brush 2 in 1
D 2-in-1 Kupferrohrbürste für Innen- und Außenreinigung
PL Szczotka do rur miedzianych 2 w 1
RUS Щетка для внутренней и внешней зачистки медных труб
CZ Kartač vnitřní a vnější na měděné trubky

- H Rézcső tisztító kefe 2 in 1
RO Perii pt. tevi de cupru 2 in 1
F Brosse aux tubes en cuivre
I Spazzola per il tubi di rame 2 in 1
E 2-en-1 cepillo para limpieza de tubos de cobre int. y ext
CN 2合1管子刷



SLIDING CARD

YATO	external & internal pipe diameter / zewnętrzna i wewnętrzna średnica rury (mm)	
YT-63705	15; 22	50/100

- GB Cleaning pad set for copper pipes
D Reinigungsvlies-satz für kupferrohre
PL Włóknina do czyszczenia rur miedzianych
RUS Губка абразивная
CZ Brusné rouno
H Tisztítószivacs

- RO Burete abraziv
F Tampons de nettoyage
I Fibra abrasiva per la pulizia de tubo di rame
E Almohadilla abrasiva
CN 件套工业洁

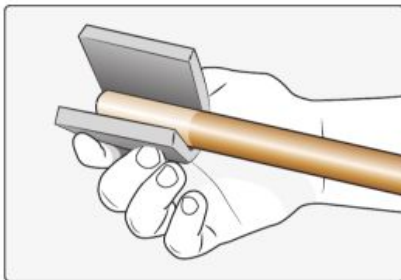

COLOR SLEEVE

YATO	size / rozmiar (mm)	
YT-63740	75x130	50

11



- GB Tool box
D Werkzeugkasten
PL Skrzynka narzędziowa
RUS Инструментальный ящик
CZ Skříňka na nářadí
H Szerszámos láda

- RO Cutie de scule
F Boîte à outils
I Cassetta degli attrezzi
E Caja de herramientas
CN 工具箱

WHITE CARTON BOX & COLOR LABEL

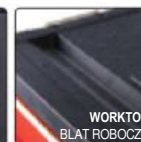

390x215x130 mm
max 10 kg



390x215x60 mm
max 5 kg

390x215x60 mm
max 5 kg

YATO	drawers / szuflady	
YT-09108	1	2

YATO	drawers / szuflady	
YT-09107	2	2

- GB Tool trolley
- D Werkzeugkasten
- PL Wózek narzędziowy 3-częściowy
- RUS Тележка инструментальная
- CZ Vozík na nářadí
- H Szerszám kocsi
- RO Troler pt. scule
- F Servante d'atelier
- I Armadio per utensili
- E Herramienta carro
- CN 工具箱



420x220x150 mm
max 20 kg

390x215x130 mm
max 10 kg

410x210x280 mm
max 15 kg

420x220x150 mm
max 20 kg

390x215x60 mm
max 5 kg

410x210x280 mm
max 15 kg



WHITE
CARTON BOX
& COLOR LABEL



YATO

YT-09102



1

YATO

YT-09101



1

- GB Tool trolley
- RUS Тележка инструментальная
- F Servante d'atelier
- D Werkzeugkasten
- CZ Vozík na nářadí
- I Armadio per utensili
- PL Wózek narzędziowy 3-częściowy z narzędziami
- H Szerszám kocsi
- E Herramienta carro
- RO Troler cu scule
- CN 工具箱

WHITE CARTON BOX & COLOR LABEL

78 PCS
3 TRAYS
WEIGHT



- 1/2" (12.7 mm): 8, 10, 12, 13, 14, 15, 16, 17, 18, 19, 20, 21, 22 mm; CrV 50BV30;
- 1/2" (12.7 mm): (127 mm); CrV 50BV30;
- 1/2" (12.7 mm): (255 mm); 72T; CrV 6140;
- 3x75, 6x100; PH0x75, PH2x100 mm; S2;
- 215 mm;
- 1/4" (6.3 mm): 3.0, 3.5, 4.0, 5.5, 6.5 mm (L=25 mm); S2;
- 1/4" (6.3 mm): PH0, PH1, PH2, PH3 (L=25 mm); S2;
- 1/4" (6.3 mm): PZ0, PZ1, PZ2, PZ3 (L=25 mm); S2;
- 1/4" (6.3 mm): T10, T15 (L=25 mm); S2;
- 1/4" (6.3 mm): 2.0, 3.0, 4.0, 5.0, 6.0 mm (L=25 mm); S2;
- 1/4" (6.3 mm): 5.0, 6.0, 7.0, 8.0(x2), 9.0, 10.0, 11.0, 12.0, 13.0 mm



- 8, 10, 12, 13, 14, 15, 16, 17, 18, 19, 21 mm; CrV
- 18 mm; SK5; 18 mm; SK5; 3 m x 16 mm



- 180 mm; 160 mm; 200 mm; LONG NOSE;
- 300 mm; 16-38 mm; 2.0, 2.5, 3.0, 4.0, 5.0, 6.0, 7.0, 8.0, 10, 12 mm; CrV 6150



YATO

YT-09104



1

Hydraulic tools Narzędzia hydrauliczne

GB Drawer insert / Tool set for plumbers
 D Schubladeneinlage / Werkzeug-Set für Klempner
 PL Wkład do szuflady / Zestaw narzędziowy dla hydraulików
 RUS Вклад к выдвижному ящику / Набор инструментов для водопроводчик
 CZ Vložka do zásuvky / Sada nářadí pro instalatér
 H Fiókbetét / Szerszámkészlet vízvezeték-szerelő

RO Adaos la sertar / Set de instrumente pt. instalator
 F Module plastique pour servante / Un ensemble d'outils pour les plombier
 I Tenone per l'armadio / Tool set per idraulici
 E Accesorio de cajón / Un conjunto de herramientas para fontanero
 CN 水管工具组套



PLASTIC TRAY
& COLOR LABEL



250 mm; 330 mm;
 250 mm; 15 m x 19 mm

250 mm; 300 mm;
 250 mm; 3-32 mm;

63 mm; 6-45 mm;
 15 m x 22 mm;

4 PCS CrV CrMo

5 PCS CrV CrMo

10 m x 12 mm

5 PCS HSS 8CrB

10 m x 12 mm;

YATO 5
 YT-55480

YATO 5
 YT-55481

YATO 5
 YT-55482

11

Memo

12

Fastening tools Narzędzia do łączenia



Hand riveters & rivet nuts
Nitownice ręczne i nitonakrętki

218-220



Pneumatic stitching & nailing machines
Zszywacze i gwoździarki pneumatyczne

225-226



Hand riveters

Nitownice ręczne..... 218

Hand riveting tools

Nitownice ręczne, dźwigniowe..... 218

Hand nut tools

Nitownice do nitonakrętek..... 219

Threaded rivet nuts

Nitonakrętki..... 220

Pneumatic staplers

Zszywacze pneumatyczne..... 225

Pneumatic nailers

Gwoździarki pneumatyczne..... 226

Staples

Zszywki..... 226

Nails

Gwoździe..... 226

Pneumatic riveters

Nitownice pneumatyczne

221



Foam guns

Pistolety do pianki

227



Pliers for hollow expansion bolts

Zaciskarki do kołków typu Molly

221-222



Caulking guns

Wyciskacze do mas

227



Screw, plug & nail sets

Zestawy wkrętów, kołków i gwoździ

222-223



Burners & soldering tools

Palniki i lutownice

228-230



Staple guns & staples

Zszywacze i zszywki

224-225



Glue guns

Pistolety do klejenia

230



Staple guns

Zszywacze..... 224

Staple removers

Rozszywacze..... 224

Staples

Zszywki..... 225

Nails

Gwoździe..... 225

Glue sticks

Wkłady klejowe

230-231



Jigs & patterns

Wzorniki i szablony

231

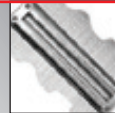

GB Hand riveter
D Blindnietzange
PL Nitownica ręczna
RUS Заклепочник
CZ Ruční nýtovačka
H Kézi pöpszegecsűzö

RO Presă de nituit manuală
F Riveteuse manuelle
I Rivettatrice manuale
E Remachadora de mano
CN 拉铆枪



x4
CrV

280 mm



DOUBLE BLISTER

YATO	Ø (mm)	L (mm)	
YT-3600	2.4; 3.2; 4.0; 4.8	280	6/24

GB Hand riveter
D Blindnietzange
PL Nitownica ręczna
RUS Заклепочник
CZ Ruční nýtovačka
H Kézi pöpszegecsűzö

RO Presă de nituit manuală
F Riveteuse manuelle
I Rivettatrice manuale
E Remachadora de mano
CN 拉铆枪



x4
20Cr

250 mm



DOUBLE BLISTER

YATO	Ø (mm)	L (mm)	
YT-36007	2.4; 3.2; 4.0; 4.8	250	6/24

GB Hand riveter
D Blindnietzange
PL Nitownica ręczna
RUS Заклепочник
CZ Ruční nýtovačka
H Kézi pöpszegecsűzö

RO Presă de nituit manuală
F Riveteuse manuelle
I Rivettatrice manuale
E Remachadora de mano
CN 拉铆枪



x4
CrMo

200 mm



COLOR BOX

YATO	Ø (mm)	L (mm)	
YT-36012	2.4; 3.2; 4.0; 4.8	200	30

GB Hand riveter
D Blindnietzange
PL Nitownica ręczna
RUS Заклепочник
CZ Ruční nýtovačka
H Kézi pöpszegecsűzö

RO Presă de nituit manuală
F Riveteuse manuelle
I Rivettatrice manuale
E Remachadora de mano
CN 拉铆枪



x4
CrV

253 mm

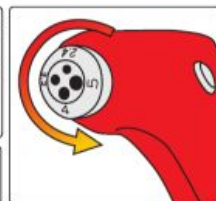

SLIDING CARD



YATO	Ø (mm)	L (mm)	
YT-36011	2.4; 3.2; 4.0; 4.8	253	12/36

GB Hand riveter
D Blindnietzange
PL Nitownica ręczna
RUS Заклепочник
CZ Ruční nýtovačka
H Kézi pöpszegecsűzö
RO Presă de nituit manuală

F Riveteuse manuelle
I Rivettatrice manuale
E Remachadora de mano
CN 拉铆枪

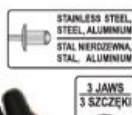

x4
CrMo

190-270 mm



COLOR BOX



YATO	Ø (mm)	L (mm)	
YT-36070	2.4; 3.2; 4.0; 4.8	190-270	20

GB Lazy tongue riveter
D Blindnietzange
PL Nitownica przemysłowa harmonijkowa czołowa
RUS Заклепочник промышленный
CZ Nýtovačka harmoniková čelná
H Harmónikás pöpszegecsűzö homlok

F Pince riveter extensible
I Rivettatrice frontale a fisarmonica industriale
E Remachadora perezoso tong
CN 重型伸缩拉铆枪



250-810 mm
x5
CrMo



COLOR BOX

YATO	Ø (mm)	L (mm)	
YT-36060	2.4; 3.2; 4.0; 4.8; 6.4	250-810	10

GB Hand riveting tool
D Blindnietzange
PL Nitownica dźwigniowa
RUS Заклепочник
CZ Nýtovačka páková
H Emeltyűs pöpszegecsűzö
RO Pcleşte pt. popnituri

F Riveteuse à levier
I Rivettatrice per rivetti a strappo
E Remachadora de palanca
CN 双把手拉铆枪



330 mm
x5
CrMo



COLOR BOX

YATO	Ø (mm)	L (mm)	
YT-3609	3.2; 4.0; 4.8; 6.0; 6.4	330	16

GB Hand riveting tool
D Blindnietzange
PL Nitownica dźwigniowa
RUS Заклепочник
CZ Nýtovačka páková
H Emeltyűs pöpszegecsűzö
RO Pcleşte pt. popnituri
F Riveteuse à levier
I Rivettatrice per rivetti a strappo
E Remachadora de palanca
CN 双把手拉铆枪



328 mm
CrMo

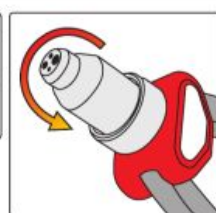

COLOR BOX

YATO	Ø (mm)	L (mm)	
YT-36092	3.2; 4.0; 4.8; 6.4	328	12

GB Hand riveting tool
D Blindnietzange
PL Nitownica dźwigniowa
RUS Заклепочник
CZ Nýtovačka páková
H Emeltyűs
RO Pclește pt. popnituri

F Riveteuse à levier
I Rivettatrice per rivetti
a strappo
E Remachadora
de palanca
CN 双把手拉铆枪



YATO	Ø (mm)	L (mm)	Box
YT-36095	2.4; 3.2; 4.0; 4.8; 6.4	380	12

GB Hand riveting tool
D Blindnietzange
PL Nitownica dźwigniowa
RUS Заклепочник
CZ Nýtovačka páková
H Emeltyűs
RO Pclește pt. popnituri

F Riveteuse à levier
I Rivettatrice per rivetti
a strappo
E Remachadora
de palanca
CN 双把手拉铆枪



YATO	Ø (mm)	L (mm)	Box
YT-36110	3.2; 4.0; 4.8; 6.0; 6.4	525	12

GB Hand nut tool
D Blindnietzange
PL Nitownica ręczna do nitonakrętek
RUS Заклепочник
CZ Nýtovačka páková
H Emeltyűs
RO Pclește pt. popnituri
F Riveteuse manuelle
aux écrous
I Rivettatrice
mano rivetto
E Remachadora
de palanca
CN 手动铆螺母枪



YATO	size / rozmiar	L (mm)	Box
YT-36140	M3; M4; M5; M6	200	20

GB Hand nut tool
D Blindnietzange
PL Nitownica ręczna
do nitonakrętek
RUS Заклепочник
CZ Nýtovačka páková
H Emeltyűs
RO Pclește pt. popnituri

F Riveteuse manuelle
aux écrous
I Rivettatrice
mano rivetto
E Remachadora
de palanca
CN 手动铆螺母枪



YATO	size / rozmiar	L (mm)	Box
YT-36112	M3; M4; M5; M6; M8	300	20

GB Hand nut tool
D Blindnietzange
PL Nitownica ręczna
do nitonakrętek
RUS Заклепочник
CZ Nýtovačka páková
H Emeltyűs
RO Pclește pt. popnituri

F Riveteuse manuelle
aux écrous
I Rivettatrice
mano rivetto
E Remachadora
de palanca
CN 手动铆螺母枪



BMC
& COLOR
SLEEVE

YATO	size / rozmiar	L (mm)	Box
YT-3612	M5; M6; M8; M10; M12	330	5

GB Hand nut tool
D Blindnietzange
PL Nitownica ręczna
do nitonakrętek
RUS Заклепочник
CZ Nýtovačka páková
H Emeltyűs
RO Pclește pt. popnituri

F Riveteuse manuelle
aux écrous
I Rivettatrice
mano rivetto
E Remachadora
de palanca
CN 手动铆螺母枪



BMC
& COLOR
BOX

YATO	size / rozmiar	L (mm)	Box
YT-36119	M5; M6; M8; M10; M12	338	6

GB Hand nut tool
D Blindnietzange
PL Nitownica ręczna
do nitonakrętek
RUS Заклепочник
CZ Nýtovačka páková
H Emeltyűs
RO Pclește pt. popnituri

F Riveteuse manuelle
aux écrous
I Rivettatrice
mano rivetto
E Remachadora
de palanca
CN 手动铆螺母枪



YATO	size / rozmiar	L (mm)	Box
YT-36127	M3; M4; M5; M6; M8; M10; M12	360	12

GB Hand nut tool
D Blindnietzange
PL Nitownica ręczna
do nitonakrętek
RUS Заклепочник
CZ Nýtovačka páková
H Emeltyűs
RO Pclește pt. popnituri

F Riveteuse manuelle
aux écrous
I Rivettatrice
mano rivetto
E Remachadora
de palanca
CN 手动铆螺母枪



BMC
& COLOR
SLEEVE

YATO	size / rozmiar	L (mm)	Box
YT-36128	M3; M4; M5; M6; M8; M10; M12	360	6

GB Hand nut tool
D Blindnietzange
PL Nitownica ręczna do nitonakrętek
RUS Заклепочник
CZ Nýtovačka ráková
H Emeltyűs
RO Pclește pt. popnituri

F Riveteuse manuelle aux écrous
I Rivetatrice mano rivetto
E Remachadora de palanca
CN 手动铆螺母枪



BMC & COLOR SLEEVE

YATO	size / rozmiar	L (mm)	
YT-36125	M3; M4; M5; M6; M8; M10; M12	420	5

GB Hand nut tool
D Blindnietzange
PL Nitownica ręczna do nitonakrętek
RUS Заклепочник
CZ Nýtovačka ráková
H Emeltyűs
RO Pclește pt. popnituri

F Riveteuse manuelle aux écrous
I Rivetatrice mano rivetto
E Remachadora de palanca
CN 手动铆螺母枪

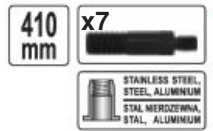

BMC & COLOR SLEEVE

YATO	size / rozmiar	L (mm)	
YT-36129	M5; M6; M8; M10; M12	410	5

GB Threaded aluminum rivet nuts
D Aluminium blindnietmutter
PL Nitonakrętki aluminiowe
RUS Алюминиевые резьбовые заклепки
CZ Nýtovací matice hlinik
H Szegecsanya aluminium

RO Piulițe nituibile
F Insert fileté aluminium
I Alluminio dadi per rivetti ciechi
E Tuercas remachadas aluminio
CN 铝制拉铆螺母

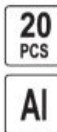

POLYBAG WITH HEADER

YATO	size / rozmiar	
YT-36451	M3	125/500
YT-36452	M4	100/400
YT-36453	M5	75/300
YT-36454	M6	50/200

GB Threaded rivet nuts
D Blindnietmutter
PL Nitonakrętki stalowe
RUS Резьбовые заклепки

CZ Nýtovací matice
H Szegecsanya
RO Nituibile
F Insert fileté

I Dadi per rivetti ciechi
E Tuercas remachadas
CN 件套铁制拉铆螺母



POLYBAG WITH HEADER

YATO	size / rozmiar	
YT-36470	M3	125/500
YT-36471	M4	100/400
YT-36472	M5	75/300
YT-36473	M6	50/200
YT-36474	M8	40/160
YT-36475	M10	25/100
YT-36476	M12	15/60

GB Threaded rivet nuts
D Blindnietmutter
PL Nitonakrętki
RUS Резьбовые заклепки

CZ Nýtovací matice
H Szegecsanya
RO Nituibile
F Insert fileté

I Dadi per rivetti ciechi
E Tuercas remachadas
CN 件套铁制拉铆螺母

PLASTIC HANGING BOX



M3x40, M4x35, M5x25, M6x25, M8x15, M10x10



M3x40, M4x35, M5x25, M6x25, M8x15, M10x10



M3x25, M4x25, M5x25, M6x25, M8x25, M10x25, M3x25, M4x25, M5x25, M6x25, M8x25, M10x25

YATO	
YT-36460	24

YATO	
YT-36481	24

YATO	
YT-36480	20

GB Pneumatic riveting machine
D Pneumatische Nietvorrichtung
PL Nitownica pneumatyczna
RUS Пневматический заклепочник
CZ Pneumatická nýtovačka
H Pneumatikus popszegecshúzó

RO Presa pneumatica pt. nituit
F Riveuse pneumatique
I Rivettatrice pneumatica
E Máquina remachadora
CN 气动拉铆枪

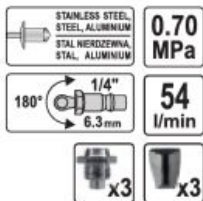

$L_{pa} = 83.6 \pm 1.9$ dB;
 $L_{wa} = 97.4 \pm 2.8$ dB;
 $a_s = 0.66 \pm 0.21$ m/s²

COLOR BOX

YATO	Ø (mm)	L (mm)	F (kg)	F (N)	
YT-36171	2.4; 3.2; 4.0; 4.8; 5.0	18	1060	10400	10

GB Pneumatic riveting machine
D Pneumatische Nietvorrichtung
PL Nitownica pneumatyczna
RUS Пневматический заклепочник
CZ Pneumatická nýtovačka
H Pneumatikus popszegecshúzó

RO Presa pneumatica pt. nituit
F Riveuse pneumatique
I Rivettatrice pneumatica
E Máquina remachadora
CN 气动拉铆枪

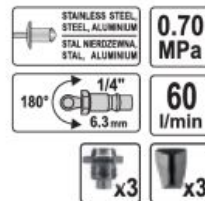

$L_{pa} = 87.2 \pm 2.3$ dB;
 $L_{wa} = 94.5 \pm 3.0$ dB;
 $a_s = 0.54 \pm 0.15$ m/s²

COLOR BOX

YATO	Ø (mm)	L (mm)	F (kg)	F (N)	
YT-36177	4.0; 4.8; 5.0; 6.4	20	1255	12300	10

GB Pneumatic riveting machine
D Pneumatische Nietvorrichtung
PL Nitownica pneumatyczna
RUS Пневматический заклепочник
CZ Pneumatická nýtovačka
H Pneumatikus popszegecshúzó

RO Presa pneumatica pt. nituit
F Riveuse pneumatique
I Rivettatrice pneumatica
E Máquina remachadora
CN 气动拉铆枪

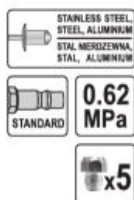

• application: industry
• przeznaczenie: przemysł

$L_{pa} = 81.2 \pm 3.0$ dB;
 $L_{wa} = 92.1 \pm 3.0$ dB;
 $a_s = 0.6 \pm 0.56$ m/s²

COLOR BOX

YATO	Ø (mm)	L (mm)	F (kg)	F (N)	
YT-3618	2.4; 3.2; 4.0; 4.8; 6.4	16	1389	13620	6

GB Pliers for hollow expansion bolts
D Maueranker-Einsetzwerkzeug
PL Zaciskarka do kołków „Molly”
RUS Клещи для дюбелей „Молли”
CZ Kotvíci kleště
H Kreater üreges fémdübel
RO Set cleste dibluri
F Pince pour chevilles creux
I Crimpatrice per pioli „Molly”
E Alicate para tacos „Molly”
CN 膨胀螺栓钳组套

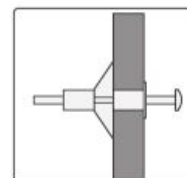

DOUBLE BLISTER

175 mm

YATO	L (mm)	
YT-51452	175	5/30

GB Pliers for hollow expansion bolts
 D Maueranker-Einsetzwerkzeug Satz
 PL Zaciskarka do kołków „Molly”
 RUS Клещи для дюбелей „Молли”
 CZ Kotvící kleště
 H Kreator üreges fémdübel

RO Set cleste dibluri
 F Pince pour chevilles creux
 I Crimpatrice per pioli „Molly”
 E Alicates para tacos „Molly”
 CN 膨胀螺栓钳组套



- 5x \varnothing 7 mm (32 mm)
- 5x \varnothing 9 mm (37 mm)
- \varnothing 4 mm (40 mm)
- \varnothing 5 mm (44 mm)

- 35x \varnothing 7 mm (32 mm)
- 10x \varnothing 9 mm (52 mm)
- 15x \varnothing 9 mm (37 mm)
- \varnothing 4 mm (40 mm)
- \varnothing 5 mm (58 mm)
- \varnothing 5 mm (44 mm)

DOUBLE BLISTER



PLASTIC BOX

10 pcs

60 pcs

YATO	
YT-51450	6/24

YATO	
YT-51451	3/12

GB Screw & plug set
 D Dübel- und Schrauben Sortiment
 PL Zestaw wkrętów i kołków rozporowych

RUS Набор крепежа шурупы и дюбеля
 CZ Set šroubů a hmoždinek
 H Csavar és tipli készlet

RO Set dibluri + holsuruburi
 F Set vis et chevilles
 I Set di viti e tasselli a espansione

E Juego de tornillos y tacos
 CN 自攻螺钉膨胀组套

PLASTIC HANGING BOX

PE



52 PCS

ZINC PLATED STAL OCYNKOWANA

WALL PLUGS / KOLKI:
 5 x 20 mm - 12 PCS, 6 x 25 mm - 8 PCS, 8 x 30 mm - 6 PCS;
 WOOD SCREWS PZ / WKRETY DO DREWNA PZ: 3.5 x 25 mm - 12 PCS,
 4 x 30 mm - 8 PCS, 5 x 30 mm - 6 PCS

104 PCS

ZINC PLATED STAL OCYNKOWANA

WALL PLUGS / KOLKI:
 5 x 25 mm - 25 PCS, 6 x 30 mm - 15 PCS, 8 x 40 mm - 8 PCS, 10 x 45 mm - 4 PCS;
 WOOD SCREWS PH / WKRETY DO DREWNA PH:
 3.5 x 25 mm - 25 PCS, 4 x 25 mm - 15 PCS, 5 x 30 mm - 8 PCS, 6 x 38 mm - 4 PCS

YATO	
YT-36505	20/60

YATO	
YT-36504	12/60



170 PCS

ZINC PLATED STAL OCYNKOWANA

WALL PLUGS / KOLKI:
 5 x 25 mm - 40 PCS, 6 x 30 mm - 25 PCS, 8 x 40 mm - 12 PCS, 10 x 45 mm - 8 PCS;
 WOOD SCREWS PZ / WKRETY DO DREWNA PZ:
 3.5 x 30 mm - 40 PCS, 4 x 40 mm - 25 PCS, 5 x 50 mm - 12 PCS, 6 x 60 mm - 8 PCS

266 PCS

4 x 20 mm - 80 PCS, 5 x 25 mm - 50 PCS, 6 x 30 mm - 60 PCS,
 7 x 35 mm - 30 PCS, 8 x 40 mm - 30 PCS, 10 x 45 mm - 12 PCS,
 12 x 60 mm - 4 PCS

YATO	
YT-36503	18/36

YATO	
YT-36502	8/16

GB Screw & plug set
D Dübel- und Schrauben Sortiment
PL Zestaw wkrętów i kołków rozporowych
RUS Набор крепежа шурупы и дюбеля

CZ Set šroubů a hmoždinek
H Csavar és tipli készlet
RO Set dibluri+holşuruburi
F Set vis et chevilles

I Set di viti e tasselli a espansione
E Juego de tornillos y tacos
CN 自攻螺钉膨胀组套

PLASTIC
HANGING BOX



ZINC
PLATED
STAL
OCYNKOWANA

PE



WALL PLUGS / KOŁKI:

5 x 20 mm - 50 PCS, 6 x 25 mm - 50 PCS,
7 x 25 mm - 40 PCS, 8 x 30 mm - 20 PCS, 10 x 38 mm - 15 PCS;
WOOD SCREWS PZ / WKRETY DO DREWNA PZ:
3.5 x 25 mm - 35 PCS, 4.0 x 25 mm - 30 PCS, 5.0 x 30 mm - 20 PCS,
5.0 x 38 mm - 15 PCS, 3.5 x 20 mm - 30 PCS, 4 x 25 mm - 25 PCS, 4 x 30 mm - 20 PCS

350
PCS

WALL PLUGS / KOŁKI:

5 x 25 mm - 90 PCS, 6 x 30 mm - 40 PCS, 8 x 38 mm - 25 PCS;
WOOD SCREWS HEX / WKRETY DO DREWNA HEX:
6 x 40 mm - 15 PCS, 6 x 50 mm - 15 PCS, 6 x 60 mm - 15 PCS;
WOOD SCREWS PZ / WKRETY DO DREWNA PZ:
3 x 19 mm - 100 PCS, 3.5 x 25 mm - 70 PCS, 4 x 30 mm - 50 PCS,
4 x 40 mm - 40 PCS, 4 x 50 mm - 30 PCS, 5 x 50 mm - 25 PCS,
5 x 60 mm - 15 PCS, 5 x 70 mm - 10 PCS, 5 x 80 mm - 10 PCS;
NUTS / NAKRĘTKI: 70 PCS

620
PCS

YATO	
YT-36501	8/16

YATO	
YT-36500	5/10

GB Hardened knurled nails assortment
D Stahlnägel geriffelt Sortiment
PL Radekowane gwoździe do betonu
RUS Гвозди оцинкованные для бетона

CZ Kalený hřebík do betonu
H Recézett szeg készlet
RO Set cuie striate
F Assortiment de clous mousés harnes

I Chiodi zigrinati per calcestruzzo
E Jogo de pregos durados com erradas
CN 竹节钉组套

106
PCS

ZINC
PLATED
STAL
OCYNKOWANA



PLASTIC
HANGING BOX



3.5 x 50 mm - 66 PCS, 3.5 x 70 mm - 40 PCS

YATO	
YT-36510	12/24

GB Screw assortment
D Spanplattenschrauben
Sortiment
PL Zestaw wkrętów

RUS Набор винтов
CZ Šrouby
H Csavar készlet
RO Set holşuruburi

F Set vis à bois
I Viti autoperforanti
E Juego de tornillos
CN 木螺钉组套

PLASTIC
HANGING BOX



ZINC
PLATED
STAL
OCYNKOWANA



WOOD SCREWS PZ / WKRETY DO DREWNA PZ:

3 x 16 mm - 35 PCS, 3.5 x 12 mm - 25 PCS, 4 x 19 mm - 25 PCS,
4 x 25 mm - 25 PCS, 4 x 30 mm - 17 PCS, 5 x 30 mm - 12 PCS,
5 x 40 mm - 10 PCS, 5 x 50 mm - 8 PCS, 3.5 x 19 mm - 20 PCS, 4 x 25 mm - 25 PCS

192
PCS

200
PCS

4.2 x 13 mm - 30 PCS, 4.2 x 16 mm - 30 PCS, 4.2 x 19 mm - 30 PCS,
4.2 x 25 mm - 30 PCS, 4.8 x 13 mm - 20 PCS, 4.8 x 16 mm - 20 PCS,
4.8 x 19 mm - 20 PCS, 4.8 x 25 mm - 20 PCS

YATO	
YT-36511	18/36

YATO	
YT-36512	12/24

GB Staple gun
D Tacker
PL Zszywacz tapicerski
RUS Стенлер
CZ Čalounická sešivačka

H Kárpitos tűzőgép
RO Capsator tapiterie
F Agrafeuse tapisier

I Cucitrice per tappezzerie
E Grapadora de tapicero
CN 打钉枪

DOUBLE BLISTER

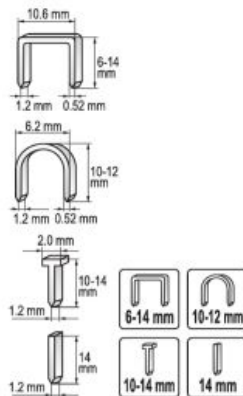

YATO YT-7000 12/24

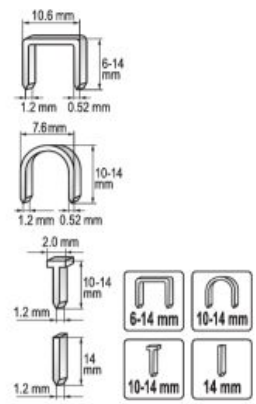

YATO YT-7001 12/24

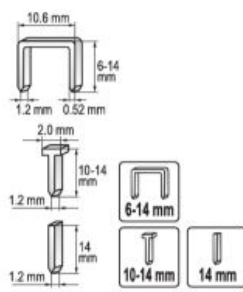

YATO YT-7003 6/24

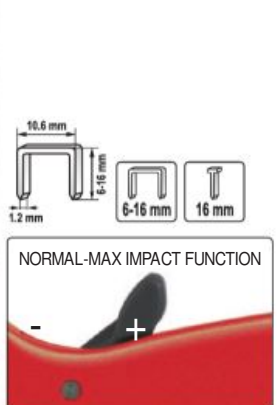

YATO staples size / rozmiar zszywki (mm) YT-7005 10.6x6.0-16.0x1.2 6/24

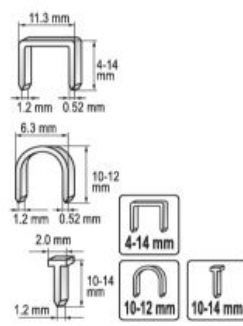

YATO YT-70020 6/24

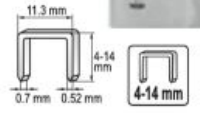
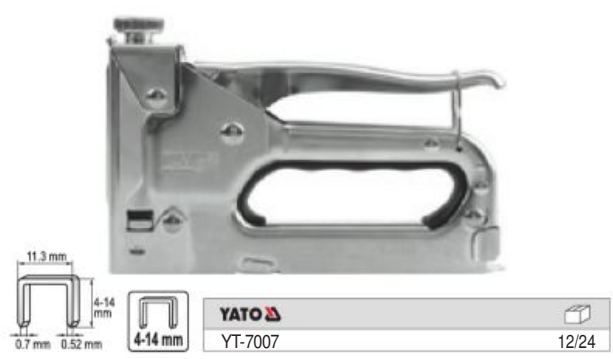

YATO YT-7007 12/24



YATO YT-70021 6/24

GB Hammer tacker
D Hammer-Tacker
PL Zszywacz młotkowy
RUS Стенлер

CZ Čalounická sešivačka
H Kárpitos tűzőgép
RO Capsator tapiterie
F Agrafeuse tapisier

I Martello cucitrice
E Grapadora de martillo
CN 钉锤

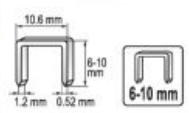

YATO YT-7004 10/20

GB Staple remover
D Klammern abwender
PL Rozszywacz
RUS Скобоудалитель
CZ Rozešivač
H Kapocskiszedő
RO Extractor capse
F Degrafeuse
I Fiocco di rimozione
E Quitagrapas
CN 起钉器



YATO YT-7011 25/100

- GB Staples
D Hefklammer
PL Zszywki
- RUS Скобы
CZ Sešivky
H Tűzőkapocs
- RO Capse tapiterie
F Agrafes
I Punti
- E Grapas
CN 码钉

HANGING
COLOR
BOX

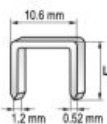

YATO L (mm)	PCS	PCS	PCS
	packing	packing	packing
YT-7022	6	1000	50/200
YT-7023	8	1000	50/200
YT-7024	10	1000	50/100
YT-7025	12	1000	50/100
YT-7026	14	1000	50/100

for / dla: YF-7000, YF-7001, YF-7003,
YF-7004, YF-7005, YF-70020, YF-70021

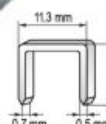

YATO L (mm)	PCS	PCS	PCS
	packing	packing	packing
YT-7051	6	1000	60/360
YT-7052	8	1000	60/300
YT-7053	10	1000	60/240
YT-7054	12	1000	50/200
YT-7055	14	1000	40/160

for / dla: YF-7006, YF-7007

- GB Nails for staple gun
D Nageln für Yato Tacker
PL Gwoździe do zszywacza
RUS Гвозди для степлера
CZ Hřebíky na sešivačku
H Szegek a tűzőgéphez
- RO Cuie pt. capsator
F Clous pour agrafeuses
I Chiodi per cucitrice
E Clavos para grapadoras
CN 直钉

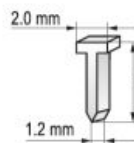

HANGING
COLOR
BOX



for / dla: YF-7000, YF-7001

YATO L (mm)	PCS	PCS	PCS
	packing	packing	packing
YT-7032	10	1000	50/200
YT-7033	12	1000	50/200
YT-7034	14	1000	50/200

- GB Pneumatic stitching machine
D Drucklufthefter
PL Zszywacz pneumatyczny
RUS Пневматический шиватель
CZ Pneumatická sešivačka
H Pneumatikus tűzőgép
RO Capsator pneumatic
F Agrafeuse pneumatique
I Cucitrice pneumatica
E Engrapadora pneumatica
CN 气动码钉枪



COLOR
BOX



L_{pA} = 88 ± 2,5 dB;
 L_{wA} = 99 ± 2,5 dB;
 a_s = 3,5 ± 1,5 m/s²

YATO	PCS
	packing
YT-09201	10

- GB Pneumatic stitching machine
D Drucklufthefter
PL Zszywacz pneumatyczny
RUS Пневматический шиватель
CZ Pneumatická sešivačka
H Pneumatikus tűzőgép
- RO Capsator pneumatic
F Agrafeuse pneumatique
I Cucitrice pneumatica
E Engrapadora pneumatica
CN 气动码钉枪



COLOR
BOX



L_{pA} = 88,6 ± 2,5 dB;
 L_{wA} = 101,6 ± 2,5 dB;
 a_s = 2,98 ± 1,5 m/s²

YATO	PCS
	packing
YT-09202	10

- GB Pneumatic stitching machine
D Drucklufthefter
PL Zszywacz pneumatyczny
RUS Пневматический шиватель
CZ Pneumatická sešivačka
H Pneumatikus tűzőgép
- RO Capsator pneumatic
F Agrafeuse pneumatique
I Cucitrice pneumatica
E Engrapadora pneumatica
CN 气动码钉枪



COLOR
BOX



L_{pA} = 87,8 ± 2,5 dB;
 L_{wA} = 100,8 ± 2,5 dB;
 a_s = 2,91 ± 1,5 m/s²

YATO	PCS
	packing
YT-09203	10

GB Pneumatic roofing coil nailer
D Pneumatischer Coilnagler für Innenausbau
PL Gwoździarka bębnowa na gwoździe papowe
RUS Пневматический нейлер для гвоздей
CZ Pneumatická hřebíkovačka na šindele
H Pneimatiskā naglošanas ierīce

RO Pistol pneumatic cu bobină pt. bătut cuipe pe acoperiș
F Cloueuse de charpente pneumatique à bandes
I Cucitrice pneumatica
E Clavadora neumática de bobina para tejados
CN 气动屋顶枪

0.7 MPa

 22-45 mm
 STANDARD

YATO
 YT-09211 3

COLOR BOX

$L_{pa} = 100,3 \pm 2,5$ dB;
 $L_{wa} = 111,3 \pm 2,5$ dB;
 $a_n = 11,3 \pm 1,5$ m/s²

GB Pneumatic roofing coil nailer
D Pneumatischer Coilnagler für Innenausbau
PL Gwoździarka bębnowa na gwoździe papowe
RUS Пневматический нейлер для гвоздей
CZ Pneumatická hřebíkovačka na šindele
H Pneimatiskā naglošanas ierīce

RO Pistol pneumatic cu bobină pt. bătut cuipe pe acoperiș
F Cloueuse de charpente pneumatique à bandes
I Cucitrice pneumatica
E Clavadora neumática de bobina para tejados
CN 气动屋顶枪

0.8 MPa

 25-57 mm
 STANDARD

YATO
 YT-09212 3

COLOR BOX

$L_{pa} = 88,6 \pm 2,5$ dB;
 $L_{wa} = 101,6 \pm 2,5$ dB;
 $a_n = 3,73 \pm 0,8$ m/s²

GB Pneumatic roofing coil nailer
D Pneumatischer Coilnagler für Innenausbau
PL Gwoździarka bębnowa na gwoździe papowe
RUS Пневматический нейлер для гвоздей
CZ Pneumatická hřebíkovačka na šindele
H Pneimatiskā naglošanas ierīce

RO Pistol pneumatic cu bobină pt. bătut cuipe pe acoperiș
F Cloueuse de charpente pneumatique à bandes
I Cucitrice pneumatica
E Clavadora neumática de bobina para tejados
CN 气动屋顶枪

0.8 MPa

 45-70 mm
 STANDARD

YATO
 YT-09213 3

COLOR BOX

$L_{pa} = 90,8 \pm 2,5$ dB;
 $L_{wa} = 103,8 \pm 2,5$ dB;
 $a_n = 4,09 \pm 0,9$ m/s²

GB Pneumatic roofing coil nailer
D Pneumatischer Coilnagler für Innenausbau
PL Gwoździarka bębnowa na gwoździe papowe
RUS Пневматический нейлер для гвоздей
CZ Pneumatická hřebíkovačka na šindele
H Pneimatiskā naglošanas ierīce

RO Pistol pneumatic cu bobină pt. bătut cuipe pe acoperiș
F Cloueuse de charpente pneumatique à bandes
I Cucitrice pneumatica
E Clavadora neumática de bobina para tejados
CN 气动屋顶枪

0.8 MPa

 50-80 mm
 STANDARD

YATO
 YT-09214 2

COLOR BOX

$L_{pa} = 92,3 \pm 2,5$ dB;
 $L_{wa} = 105,3 \pm 2,5$ dB;
 $a_n = 5,37 \pm 1,5$ m/s²

GB Staples
D Heftklammern
PL Zszywki
RUS Скобы
CZ Sešivky
H Tūzōkarpos

RO Capse tapiterie
F Agrafes
I Punti
E Grapas
CN 码钉

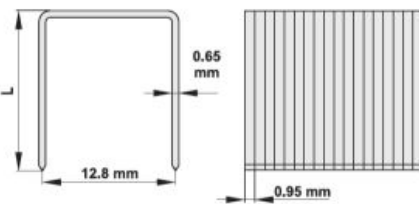

COLOR BOX

for / dla: YT-0920

YATO	L (mm)	PCS
YT-0930	8	100
YT-0931	16	50
YT-0932	25	50

GB Nails
D Nägel
PL Gwoździe
RUS Гвозди
CZ Hřebíky
H Szeg

RO Cuipe
F Clous
I Chiodi
E Clavos
CN 直钉

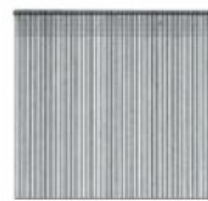
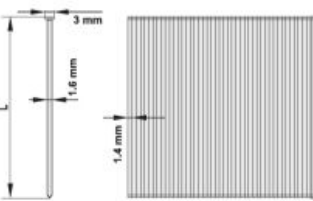

COLOR BOX

for / dla: YT-0921

YATO	L (mm)	PCS	90°
YT-0941	50	20	
YT-0942	64	20	

for / dla: YT-0922

YATO	L (mm)	PCS	34°
YT-0938	38	20	
YT-0939	50	20	
YT-0940	64	20	

for / dla: YT-0923, YT-0927

YATO	L (mm)	PCS	34°
YT-0935	50	10	
YT-0936	75	10	
YT-0937	90	10	

GB Foam gun
D Farbspritzpistole
PL Pistolet do pianki montażowej
RUS Пистолет для нанесения полиуретановой пены

CZ Pistole na montážní pěnu
H Felrakó pisztoly, poliurethán habhoz
RO Pistol pt. spumă

F Pistolet mousse expansive
I Pistola per schiuma poliuretanică

E Pistola para espuma de montaje de metal
CN 发泡枪

COLOR BOX

PTFE
COATED
POWLOKA



YATO 10/20
YT-6740

YATO 10/20
YT-6741

YATO 10/20
YT-6742



YATO 20
YT-6743

YATO 20
YT-6744

YATO 20
YT-6745

GB Caulking gun
D Kartuschenpistole
PL Wyciskacz do mas
RUS Пистолет для герметика
CZ Protlačovač na hmoty
H Masszakinyomó

RO Pistol silicon
F Pistolet à feutrer
I Pistola per silicone
E Pistola para masilla
CN 堵缝枪



300 ml

225 mm

225 mm

YATO L (mm) 10/20
YT-6751 225

YATO L (mm) 10/20
YT-6752 225

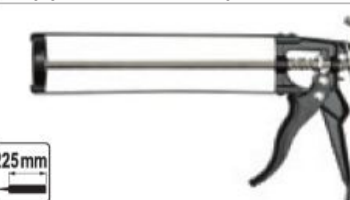

225 mm

225 mm

225 mm

YATO L (mm) 6/12
YT-6753 225

YATO L (mm) 10/20
YT-6754 225

YATO L (mm) 20/40
YT-6750 225



225 mm

216 mm
160 mm

200 mm
165 mm

YATO L (mm) 10/20
YT-6755 225

YATO L (mm) 6/12
YT-6756 215

YATO L (mm) 10/20
YT-6757 200

GB Mortar gun with nozzles kit
D Mörtelspritze
PL Wyciskacz do fugowania

RUS Пистолет для затирки швов
CZ Pistole vytlačovací
H Kinyomó pisztoly

RO Pistol pt. silicon
F Seringue mortier
I Pistola per silicone

E Pistola para calafatear mortero
CN 堵缝枪



COLOR BOX



1L
CAPACITY
POLSKA
AI

DOUBLE
BLISTER



YATO 10
YT-67580

YATO 12
YT-67583

- GB Gas torch
- D Gasbrenner
- PL Palnik gazowy
- RUS Газовая паяльная лампа
- CZ Plynový hořák
- H Gázégő
- RO Arzător de gaz
- F Bruleur à gaz
- I Saldatore bruciatore a gas
- E Soplete de gas
- CN 火焰枪



PIEZO	30 ml	60-90 min	GAS GAZ
LOCK BLOKADA	BUTANE lighter gas BUTAN (gas de aprindere)	CHILD PROTECTION (ZABRANJEN PRISTUP DECIJAM)	



1300°C

YATO	
YT-36700	10/20

DOUBLE BLISTER



- GB Soldering tool set
- D Gaslötkolben satz
- PL Lutownica gazowa z akcesoriami
- RUS Газовый паяльный набор
- CZ Plynova pajka souprava
- H Gaz forrasztópaka készletek
- RO Set ciocan de lipit cu gaz
- F Fer à souder à gaz
- I Saldatore a gas
- E Soldador a gas con accesorios
- CN 自动点火多功能瓦斯组套

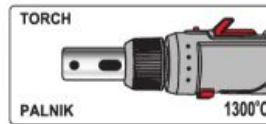
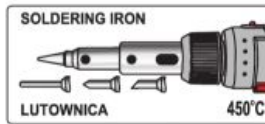

7 PCS	30-125 W	30 ml	75 min
GAS GAZ	PIEZO	LOCK BLOKADA	BUTANE lighter gas BUTAN (gas de aprindere)
PROPANE-BUTANE lighter gas PROPAN-BUTAN (gas de aprindere)	CHILD PROTECTION (ZABRANJEN PRISTUP DECIJAM)		

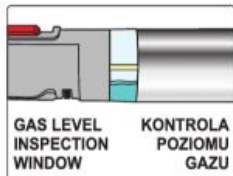

GAS LEVEL INSPECTION WINDOW
KONTROLA POZIOMU GAZU

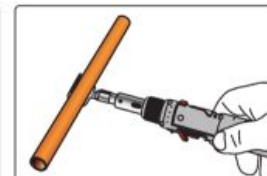

PLASTIC BOX & HANGING COLOR BOX

YATO	W
YT-36706	30-125 6

- GB Soldering tool 3 in 1
- D Gaslötkolben 3 in 1
- PL Lutownica gazowa 3 w 1
- RUS Газовый паяльник 3-в-1
- CZ Plynova pajka 3 in 1
- H Gaz-forrasztópaka 3 in 1
- RO Ciocan de lipit cu gaz 3 in 1
- F Fer à souder à gaz
- I Saldatore a gas
- E Soldador de gas 3 in 1
- CN 瓦斯焊接工具



PIEZO	30~70 W	12 ml	60 min	GAS GAZ
LOCK BLOKADA	BUTANE lighter gas BUTAN (gas de aprindere)	PROPANE-BUTANE lighter gas PROPAN-BUTAN (gas de aprindere)	CHILD PROTECTION (ZABRANJEN PRISTUP DECIJAM)	

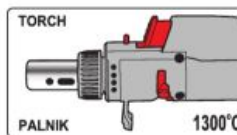
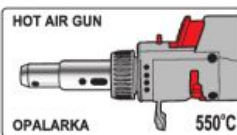
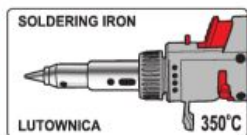

GAS LEVEL INSPECTION WINDOW
KONTROLA POZIOMU GAZU

SLIDING CARD

YATO	W
YT-36704	30-70 12/72

- GB Gas blow torch
- D Lötbrenner
- PL Palnik gazowy
- RUS Газовая горелка
- CZ Plynový hořák
- H Gázégő
- RO Arzător de gaz
- F Bruleur à gaz
- I Saldatore bruciatore a gas
- E Soplete de gas
- CN 火焰枪



1000°C

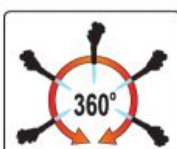

EURO TYPE EN417



PIEZO	1.0 kW	73 g/h	GAS GAZ	BUTANE BUTAN
-------	--------	--------	---------	--------------

SLIDING CARD

YATO	kW
YT-36710	1.0 10/100

GB Gas blow torch
D Lötbrenner
PL Palnik gazowy
RUS Газовая горелка

CZ Plynový hořák
H Gázégő
RO Arzător de gaz
F Bruleur à gaz

I Saldatore bruciatore a gas
E Soplete de gas
CN 火焰枪

PIEZO 1.28 kW GAS GAZ AIR POWIERZE LOCK BLOKADA BUTANE BUTAN

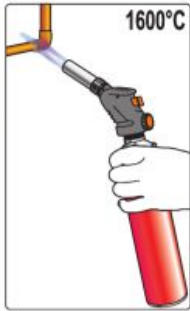

SLIDING CARD

YATO	kW	
YT-36709	1.28	6/12

GB Turbo gas torch
D Turbo-Handbrenner
PL Palnik gazowy turbo
RUS Газовая горелка турбо
CZ Plynový hořák turbo
H Kézi gázégő
RO Arzător cu gaz turbo
F Bruleur à gaz turbo
I Saldatore bruciatore a gas
E Quemador de gas turbo
CN 手持式焊枪



PIEZO 2800°C 2.0 kW 142 g/h 2.59 MPa
G1" F PROPAN GAS GAZ AUTO START STOP
LOCK BLOKADA CONTINUOUS BURN LOCK (BLOCKA PRACY GAZEM) TURBO NOZZLE (DYSZA TURBO)

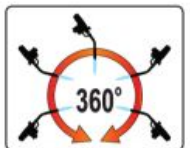

DOUBLE BLISTER

YATO	kW	
YT-36715	2.0	20

GB Soldering iron
D LötKolben
PL Lutownica oporowa

RUS Электродоупаяльник
CZ Pájka odporová
H Forrasztópáka

RO Ciocan de lipit
F Fer à souder
I Saldatore a stagno

E Soldador de resistencia
CN 电烙铁

HANGING DISPLAY COLOR BOX

230V~50Hz 400-520 °C 2-3 min



YATO	W	max. temperature of soldering tip / max. temperatura grotu (°C)	dimensions of soldering tip / wymiary grotu (mm)	
YT-8271	30	400	ø3.8 x 70	16
YT-8272	60	500	ø6.0 x 78	16
YT-8273	80	520	ø6.8 x 64	16

GB Desoldering pump
D Entlötsaugpumpe
PL Odsysacz do cyny
RUS Шприц для удаления припоя
CZ Odrájecí sací pumpa
H Onszippantó

RO Pompa fluidor
F Pompe à étain
I Pompa aspira stagno
E Bomba desoldadora
CN 全铝手动吸锡器

SLIDING CARD

PTFE TIP

GB Transformer soldering gun
D Lötpestole
PL Lutownica transformatorowa
RUS Поаяльник электрический
CZ Transformátorová páječka
H Forrasztópáka
RO Aparat de lipit leton cu transformator

F Fer à souder
I Saldatore istantaneo
E Soldador transformador
CN 电烙铁

230V~50Hz 180 W WORKING MODE TRYB PRACY S2 20% 0-600 °C LED



YATO	
YT-82742	100/400



YATO	
YT-82743	100/200



YATO	
YT-82744	50/100



WORK LIGHT OŚWIETLENIE PRACY

BMC & COLOR SLEEVE

YATO	W	temp. (°C)	
YT-8245	180	0-600	10

- GB Transformer soldering gun
- D Lötstiftle
- PL Lutownica transformatorowa
- RUS Паяльник электрический
- CZ Transformátorová páječka
- H Forrasztópáka
- RO Aparat de lipid letcon cu transformator
- F Fer à souder
- I Saldatore istantaneo
- E Soldador transformador
- CN 电烙铁

230V~50Hz 200 W LED

WORKING MODE TRIVB PRACY S2 20%

351-500°C 201-350°C 70-200°C



WORK LIGHT
OŚWIELENIE PRACY

BMC & COLOR SLEEVE

YATO	W	temp. (°C)	
YT-82451	200	70-500	10

- GB Soldering station
- D Lötstation
- PL Stacja lutownicza
- RUS Паяльная станция
- CZ Letovací stanice
- H Forrasztópáka állomás
- RO Stație de lipit
- F Station de soudage
- I Stazione digitale di saldatura
- E Estación de soldadura
- CN 数显焊台

1°C

230V~50Hz 48 W 150-450 °C

7.1 mm 65 mm LCD DISPLAY WYWIETLACZ



COLOR BOX

YATO	W	temp. (°C)	
YT-82455	48	150-450	4

- GB Electric glue gun
- D Heissklebepistole
- PL Pistolet do klejenia
- RUS Пистолет для клея
- CZ Pistolet na lepení
- H Ragasztópisztoly

- RO Pistol pt. lipit
- F Pistolet à colle
- I Pistola colla
- E Pistola de cola
- CN 热胶枪

230V~50Hz 35 (400) W 150-200 °C 15 g/min

3-6 min ∅ 11 mm



COLOR BOX

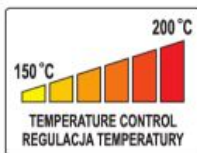

YATO	W	diameter of glue stick średnica wkładu (mm)	capacity wydajność (g/min)	
YT-82401	35 (400)	11	15	12/24

- GB Electric glue gun
- D Heissklebepistole
- PL Pistolet do klejenia
- RUS Пистолет для клея
- CZ Pistolet na lepení
- H Ragasztópisztoly

- RO Pistol pt. lipit
- F Pistolet à colle
- I Pistola colla
- E Pistola de cola
- CN 热胶枪

230V~50Hz 20 (80) W 180-200 °C 15 g/min

3-5 min 3x ∅11mm



DOUBLE BLISTER

YATO	W	diameter of glue stick średnica wkładu (mm)	capacity wydajność (g/min)	
YT-82402	20 (80)	11	15	12/48

- GB Glue sticks
- D Heissklebepatronen
- PL Wkłady klejowe
- RUS Стержин для горячей склейки
- CZ Lepící vložky

- H Ragasztótétét
- RO Mine cu clei
- F Des bâtons de colle

- I Stick di colla
- E Cartucho de cola
- CN 透明热熔胶棒

POLYBAG

1kg

WORKING TEMPERATURE TEMPERATURA PRACY 170-200°C

SOFTENING POINT TEMPERATURA MĘKNIECIA 82H-2°C

OPEN TIME CZAS OTWARCIA 20-30 s

TRANSPARENT BEZBARWNE



∅ 11 mm 200 mm

YATO	size / rozmiar (mm)	
YT-82430	∅11 / 200	120



∅ 11 mm 300 mm

YATO	size / rozmiar (mm)	
YT-82431	∅11 / 300	20

GB Glue sticks
D Heissklebpatronen
PL Wkłady klejowe

RUS Стержин для горячей склейки
CZ Lepicí vložky

H Ragasztóbetét
RO Mine cu clei
F Des bâtons de colle

I Stick di colla
E Cartucho de cola
CN 色热熔胶棒

COLOR BOX
WITH
WINDOW

5
PCS

Ø 11 mm
200 mm

WORKING TEMPERATURE
TEMPERATURA PRACY
170-200°C

SOFTENING POINT
TEMPERATURA MIĘKNIĘCIA
85+2°C

OPEN TIME
CZAS OTWARCIA
20-30 s



YATO	color / kolor	size / rozmiar (mm)	
YT-82433	●	Ø 11 / 200	40/120
YT-82434	●	Ø 11 / 200	40/120
YT-82435	●	Ø 11 / 200	40/120
YT-82436	●	Ø 11 / 200	40/120

YATO	color / kolor	size / rozmiar (mm)	
YT-82437	●	Ø 11 / 200	40/120
YT-82438	●	Ø 11 / 200	40/120
YT-82439	●	Ø 11 / 200	40/120

GB Glue sticks
D Heissklebpatronen
PL Wkłady klejowe

RUS Стержин для горячей склейки
CZ Lepicí vložky

H Ragasztóbetét
RO Mine cu clei
F Des bâtons de colle

I Stick di colla
E Cartucho de cola
CN 色热熔胶棒

COLOR BOX
WITH
WINDOW

10
PCS

Ø 7.2 mm
200 mm

WORKING TEMPERATURE
TEMPERATURA PRACY
170-200°C

SOFTENING POINT
TEMPERATURA MIĘKNIĘCIA
82+2°C

OPEN TIME
CZAS OTWARCIA
20-30 s

TRANSPARENT
BEZBARWNE



YATO	color / kolor	size / rozmiar (mm)	
YT-82440	transparent / bezbarwne	Ø 7.2 / 200	30/120

GB Glue sticks
D Heissklebpatronen
PL Wkłady klejowe
RUS Стержин для горячей склейки

CZ Lepicí vložky
H Ragasztóbetét
RO Mine cu clei
F Des bâtons de colle

I Stick di colla
E Cartucho de cola
CN 色热熔胶棒



12
PCS

Ø 7.2 mm
100 mm

WORKING TEMPERATURE
TEMPERATURA PRACY
170-200°C

SOFTENING POINT
TEMPERATURA MIĘKNIĘCIA
85+2°C

OPEN TIME
CZAS OTWARCIA
20-30 s

YATO	color / kolor	size / rozmiar (mm)	
YT-82441	●	Ø 7.2 / 100	50/200
YT-82442	●	Ø 7.2 / 100	50/200
YT-82443	●	Ø 7.2 / 100	50/200
YT-82444	●	Ø 7.2 / 100	50/200

YATO	color / kolor	size / rozmiar (mm)	
YT-82445	●	Ø 7.2 / 100	50/200
YT-82446	●	Ø 7.2 / 100	50/200
YT-82447	●	Ø 7.2 / 100	50/200

GB Kitchen worktop jig
D Frässhablone Arbeitsplatte
PL Szablon do łączenia blatów
RUS Шаблон для кухонных столешниц
CZ Šablona pro spoj kuchyňských desek
H Munkalap összemaró sablon
RO Șablon pentru frezare

F Gabarit de profilage pour plans de travail
I Sistema di giunzioni per piani da cucina
E Plantilla para el fresado de encimeras
CN 木工模板

1000x390x53
mm

700
mm
HARDENED LAMINATE
UTWARDZANY



GREY CARTON BOX & COLOR LABEL

YATO	
YT-70890	5

GB Steel contour gauge
D Profilmuster
PL Wzornik do kopiowania kształtów
RUS Шаблон профилей
CZ Profilová šablona
H Profilsablon

RO Șablon profile
F Jauges d'épaisseurs métriques
I Sagoma di contorno
E Plantilla de perfles
CN 仿形规

150 mm
46 mm

STEEL NEEDLES
STALOWE IGLY

mm
inch

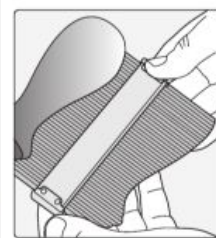

SLIDING CARD



YATO	
YT-70870	12/48

GB Profile gauge
D Profilmuster
PL Wzornik profili

RUS Шаблон профилей
CZ Profilová šablona
H Profilsablon

RO Șablon profile
F Jauges d'épaisseurs métriques

I Profilato
E Plantilla de perfles
CN 轮廓仪

SLIDING CARD

44 mm
1.5 mm



YATO	L (mm)	
YT-3735	125	24/72

YATO	L (mm)	
YT-3736	260	10/40

13

Construction tools Narzędzia budowlane



Floor laminate cutters & accessories
Gilotyny do cięcia paneli podłogowych i akcesoria



234

Roofwork tools
Narzędzia dekarские



247-248

Tile cutting machines & accessories
Przyrządy do cięcia glazury i akcesoria



234-236

Floating rules
Łaty



248

Jigs & patterns
Wzorniki i szablony



236

Knives
Noże



248-249

Scrapers
Szpachelki



237

Electric hoists
Elektryczne wciągarki linowe



249

Masonry tools
Narzędzia tynkarskie i murarskie



237-241

Extension cords
Przedłużacze elektryczne



250

Floats
Pace 237
Trowels
Kielnie 240
Plaster scrubbers
Zdzieraki do tynków 240
Mortar guns
Wyciskacze do zapraw 241

Mixers
Mieszadła



251

Pencils
Ołówki



252

Tools for drywalls
Narzędzia do płyt gipsowo-kartonowych



241-242

Carpenter's pencils
Ołówki stolarskie 252
Masonry pencils
Ołówki murarskie 252

Shears
Nożyce



243-246

- GB Floor laminate cutter
 D Laminat-Schneider
 PL Gilotyina do cięcia paneli podłogowych
 RUS Гильотина для ламината
 CZ Nůžky na laminátové plovoucí podlahy
 H Laminált padló vágógép
 RO Aparat de tăiat parchet laminat
- F Guillotine pour couper les panneaux
 I Ghigliottina per taglio dei pannelli
 E Guillotina cortapaneles
 CN 木地板切割器



12 mm max. CUTTING THICKNESS GRUBOSC CIĘCIA
 210 mm max. CUTTING LENGTH DŁUGOŚĆ CIĘCIA
 ZINC PLATED CYNKOWANA

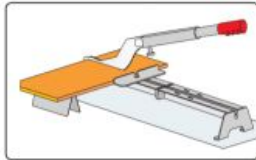
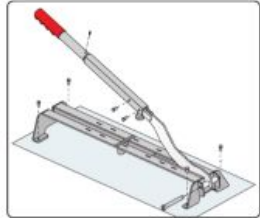

YATO		
YT-37301		2

- GB Hardwood floor positioning tool
 D Parkettzugeisen
 PL Dociągacz desek podłogowych
 RUS Струбцина отжим для монтажа ламинатных и паркетных полов
 CZ Nářadí pro montáž podlah - španovák
 H Behúzóvas profi filc alátéttel
 RO Dispozitiv fixare parchet
 F Pied de biche
 I Attrezzo di serraggio per tavole e pannelli
 E Sujetador de piso profesional
 CN 地板安装器

WHITE CARTON BOX & COLOR LABEL

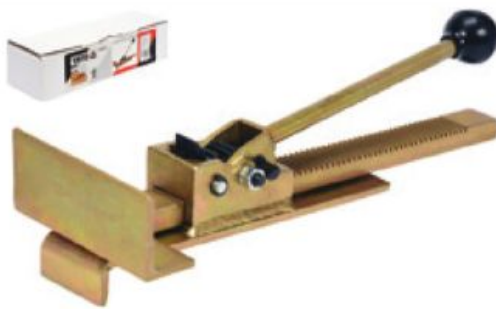

420 mm

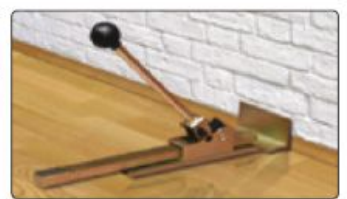

YATO	L (mm)	
YT-37317	420	6

- GB Tile cutting machine
 D Fliesenschneidmaschine
 PL Przyrząd do cięcia glazury
 RUS Плиткорез
 CZ Přístroj na řezání glazury
 H Csempevágó
- RO Instrument de tăiere a glazurei
 F Coupeuse pour la céramique
 I Ghigliottina per taglio di piastrelle
 E Cortadora de gres
 CN 瓷砖切割器

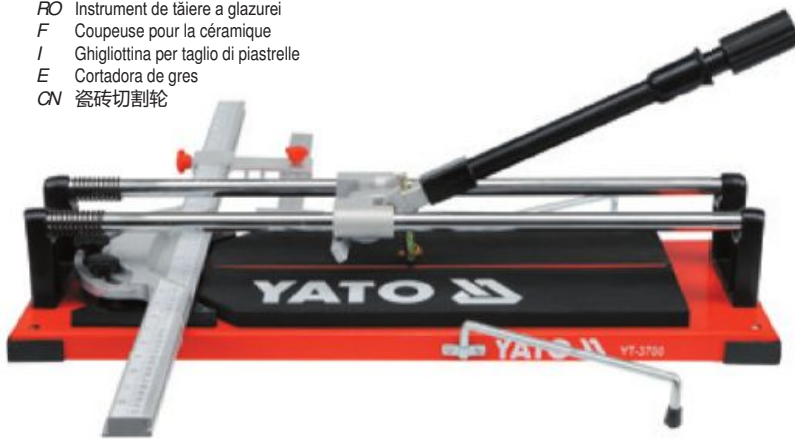

CUTTING CIĘCIE ±45°
 14 mm max. CUTTING THICKNESS GRUBOSC CIĘCIA
 22x6x2 mm
 YG6X COATED TiN POWŁOKA



YATO	L (mm)	
YT-3701	600	2

- GB Tile cutting machine
 D Fliesenschneidmaschine
 PL Przyrząd do cięcia glazury
 RUS Плиткорез
 CZ Přístroj na řezání glazury
 H Csempevágó
- RO Instrument de tăiere a glazurei
 F Coupeuse pour la céramique
 I Ghigliottina per taglio di piastrelle
 E Cortadora de gres
 CN 瓷砖切割器



CUTTING CIĘCIE 0-45°
 14 mm max. CUTTING THICKNESS GRUBOSC CIĘCIA
 12.6x3x3 mm
 YG6X COATED TiN POWŁOKA



YATO	L (mm)	
YT-3703	630	2

- GB Tile cutting wheel
 D Schneidrad
 PL Kółko tnące wymienne
- RUS Ролик для плиткореза
 CZ Výmenné kolečko
 H Cseregörgő csavarral
- RO Cuțit rolă
 F Molette coupante avec barre redondo
 I Lama di ricambio tondo
- E Recambio de cuchillo redondo
 CN 硬质合金刀片



SLIDING CARD
 YG6X COATED TiN POWŁOKA

for / dla: YT-3700, YT-3701, YT-3702

for / dla: YT-3703

YATO			YATO		
YT-3712		50/250	YT-3713		50/200

GB Tile cutting machine
D Fliesenschneidmaschine
PL Przyrząd do cięcia glazury
RUS Плиткопес
CZ Přístroj na řezání glazury
H Csempevágó
RO Instrument de tăiere a glazurei

F Coupeuse pour la céramique
I Ghigliottina per taglio di piastrelle
E Cortadora de gres
CN 瓷砖切割轮

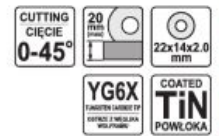

COLOR BOX



YATO	L (mm)	
YT-3705	900	1

GB Tile cutting machine
D Fliesenschneidmaschine
PL Przyrząd do cięcia glazury
RUS Плиткопес
CZ Přístroj na řezání glazury
H Csempevágó

RO Instrument de tăiere a glazurei
F Coupeuse pour la céramique
I Ghigliottina per taglio di piastrelle
E Cortadora de gres
CN 瓷砖切割轮

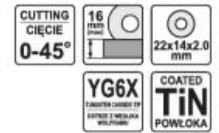

COLOR BOX



YATO	L (mm)	
YT-3706	500	2
YT-3707	600	2
YT-3708	800	2

GB Tile cutting wheel
D Schneiderrad
PL Kółko tnące wymienne

RUS Ролик для плиткореза
CZ Výměnné kolečko
H Cserégörgő csavarral

RO Cuțit rolă
F Molette coupante avec barre
I Lama di ricambio tondo

E Recambio de cuchillo redondo
CN 硬质合金刀片

SLIDING CARD



22x11x2.0 mm for / dla: YT-3704, YT-3705, YT-3706, YT-3707, YT-3708

22x14x2.0 mm for / dla: YT-3704, YT-3705, YT-3706, YT-3707, YT-3708

YATO		YATO	
YT-3714	50/200	YT-37141	50/200

GB Tile cutting machine
D Fliesenschneidmaschine
PL Przyrząd do cięcia glazury
RUS Плиткопес
CZ Přístroj na řezání glazury
H Csempevágó
RO Instrument de tăiere a glazurei
F Coupeuse pour la céramique
I Ghigliottina per taglio di piastrelle
E Cortadora de gres
CN 瓷砖切割轮



COLOR BOX



YATO	L (mm)	
YT-37034	400	4



YATO	L (mm)	
YT-37036	600	3

GB Tile cutting wheel
D Schneiderrad
PL Kółko tnące wymienne

RUS Ролик для плиткореза
CZ Výměnné kolečko
H Cserégörgő csavarral

RO Cuțit rolă
F Molette coupante avec barre
I Lama di ricambio tondo

E Recambio de cuchillo redondo
CN 硬质合金刀片

SLIDING CARD



for / dla: YT-37034, YT-37036

YATO	
YT-37038	300

GB Tile cutting pliers
D Glasurzange
PL Szczypce do cięcia i łamania glazury
RUS Кусачки для плитки
CZ Kleště do glazury
H Csempefogó

RO Cleste rupt faianta
F Pince grès mosaïque
I Tenaglia per piastrelle
E Tenazas para azulejos
CN 瓷砖钳

200 mm YG-6X



SLIDING CARD



YATO	L (mm)	
YT-37160	200	6/36

GB Tile cutting pliers
D Glasurzange
PL Szczypce do łamania glazury
RUS Кусачки для плитки
CZ Kleště do glazury
H Csempefogó

RO Cleste rupt faianta
F Pince grès mosaïque
I Tenaglia per piastrelle
E Tenazas para azulejos
CN 瓷砖钳

200 mm 2x YG-6X COATED TiN POWLOKA



SLIDING CARD



YATO	L (mm)	
YT-37161	200	6/36

GB Tile cutting pliers
D Glasurzange
PL Szczypce do glazury
RUS Кусачки для плитки
CZ Kleště do glazury
H Csempefogó
RO Cleste rupt faianta
F Pince grès mosaïque

I Tenaglia per piastrelle
E Tenazas para azulejos
CN 瓷砖钳

200 mm YG6X



SLIDING CARD



YATO	L (mm)	
YT-37164	200	6/60

GB Grout remover
D Fugenreiniger
PL Skrobak do fug
RUS Скребок для швов кладки
CZ Škrabák na spáry
H Fugakihűző

RO Răzuitoare pt. rosturi
F Grateur pour fugues
I Raschietto per fuga piastrelle
E Rascador para juntas
CN 砂浆去除器



SLIDING CARD



YATO	L (mm)	
YT-37170		10/60

GB Glaze bucket
D Fliesenwaschset
Rolleneimer
PL Wiadro glazuricze
RUS Ведро с роликами для затирки швов
CZ Malířské vědro
H Fugázó vödör
RO Galeata pt. zugravit
F Seau de peinture
I Secchio per lavaggio piastrelle
E Cubo de pintura
CN 釉桶

22L PE



YATO	l	
YT-54750	22	42

GB Steel contour gauge
D Profilmuster
PL Wzornik do kopiowania kształtów
RUS Шаблон профилей
CZ Profilová šablona
H Profilsablon

RO Șablon profil
F Jauges d'épaisseurs métriques
I Sagoma di contorno
E Plantilla de perfiles
CN 仿形规

SLIDING CARD

150 mm 46 mm STEEL NEEDLES STALOWE IGLY mm inch

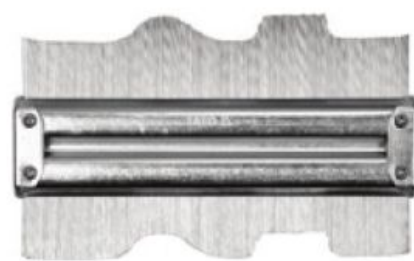
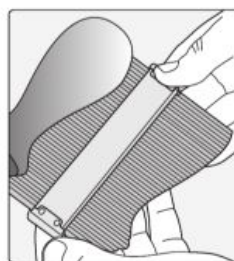

YATO	L (mm)	
YT-70870		12/48

GB Profile gauge
D Profilmuster
PL Wzornik profili

RUS Шаблон профилей
CZ Profilová šablona
H Profilsablon

RO Șablon profil
F Jauges d'épaisseurs métriques

I Profiliato
E Plantilla de perfiles
CN 轮廓仪

SLIDING CARD

44 mm 1.5 mm



YATO	L (mm)	
YT-3735	125	24/72



YATO	L (mm)	
YT-3736	260	10/40

GB Trowel for silicone
D Spachtel für Silikon
PL Szpachelka do silikonu
RUS Шпатель для силикона
CZ Špachtle na silikon

H Spachli szilikonhoz
RO Spatulă pt. silicon
F Spatule à silicone
I Spatola per silicone

E Espátula para silicona
CN 橡塑刮板



4
PCS



4
PCS



4
PCS

YATO
YT-5260 20/300

YATO
YT-5261 20/200

YATO
YT-5262 20/200

TPR

GB Silicone scraper tool kit
D Schabern zu silikonfugen satz
PL Zestaw skrobaków do fug silikonowych
RUS Набор скребками для суставов силиконовые
CZ Sada škrabky na silikonových spár
H Készlet-ből kaparók szilikon izületek

RO Set de raclete silicon articulajilor
F Jeu de grattoirs a joints en silicone
I Set di raschiatori per fughe in silicone
E Conjunto de rascadores a las juntas de silicona
CN 件套塑料美缝器组套

SLIDING CARD



ABS



2
PCS



3
PCS

YATO
YT-52630 10/60

YATO
YT-52631 10/60

GB Caulking tool set
D Fugenglätter set
PL Zestaw narzędzi do fug silikonowych
RUS Набор инструментов уплотнительных
CZ Sada nástrojů pro spoje
H Az izületek eszközök
RO Un set de instrumente pt. rosturi
F Un ensemble d'outils pour les articulations
I Set di attrezzi per fughe in silicone

E Un conjunto de herramientas para empalmes
CN 件套钢丝刷组套

4
PCS

TPR

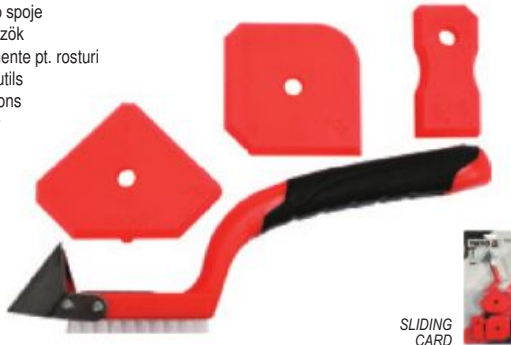

SLIDING CARD



YATO
YT-52621 12/48

GB Stucco spatulas set
D Stukkateureisen
PL Szpachelki sztukatorskie
RUS Шпатель штукатурный двухсторонний
CZ Štukatérský nástroj
H Spatulák
RO Spatula metalica
F Spatule à mouleurs
I Set di spatole per stucco
E Espátulas
CN 2件套修正刀组套

2
PCS

420

0.6mm
1.45mm

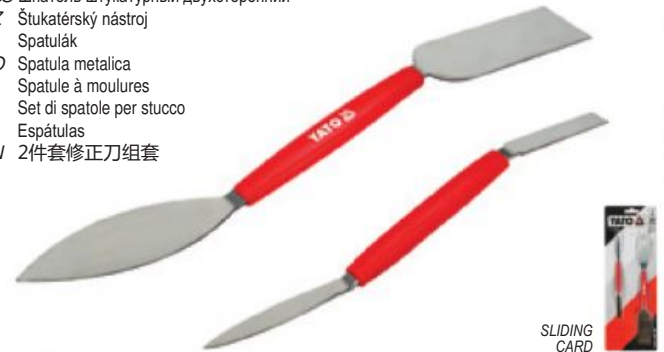

SLIDING CARD



YATO
YT-52780 6/48

GB Smooth float
D Schweizer Glättkelle
PL Paca gładka
RUS Тёрка гладкая
CZ Hladitko rovné
H Glettväs rozsdamentes
RO Gletiera

F Truelle inoxidabile
I Frattazzo liscio
E Llana para enlucido
CN 不锈钢砌墙刀

SS
STAINLESS STEEL
STAL NIERDZEWNA



• made of special cold rolled stainless steel sheet with elasticity factor up to 2000 N/mm
• części robocze ze specjalnej zimnowalcowanej blachy nierdzewnej o sprężystości do 2000 N/mm

YATO
YT-5200 mm 270x130 30

GB Float with teeth
D Zahnkelle
PL Paca zębata
RUS Тёрка с зубами
CZ Hladitko zuby
H Glettväs fogazott
RO Gletiera zimtata

F Truelle inoxidabile
I Frattazzo dentato
E Llana dentada
CN 不锈钢砌墙刀

SS
STAINLESS STEEL
STAL NIERDZEWNA



• made of special cold rolled stainless steel sheet with elasticity factor up to 2000 N/mm

• części robocze ze specjalnej zimnowalcowanej blachy nierdzewnej o sprężystości do 2000 N/mm

YATO	teeth / zęby	mm	
YT-5202	6x6	275x130	30
YT-5203	8x8	270x130	30
YT-5204	10x10	260x130	30

- GB Smooth float
D Schweizer Glättkelle
PL Paca tynkarska
RUS Тёрка гладкая
CZ Hladitko rovné
H Gletivas rozsdamentes
RO Gletiera
- F Truelle inoxidable
I Frattazzo
E Llana para enlucido
CN 不锈钢砌墙刀



• made of special cold rolled stainless steel sheet with elasticity factor up to 2000 N/mm
• części robocze ze specjalnej zimnowalcowanej blachy nierdzewnej o sprężystości do 2000 N/mm

YATO	mm	
YT-5207	380x130	10
YT-5209	480x130	10
YT-5210	580x130	10

- GB Sharp ground float
D Steinholzglätter
PL Paca ostra
RUS Стальная острая тёрка
CZ Hladitko ocelové, špičaté
H Aljzatsimitó
- RO Gletiera cu varf ascutit
F Truelle acier
I Frattazzo acuto
E Llana pontiaguda
CN 不锈钢砌墙刀



YATO	mm	
YT-5212	500	20

- GB Smooth float
D Glättkelle
PL Paca wenecka
RUS Тёрка венецианская
CZ Hladitko rovné
H Gletivas rozsdamentes
RO Gletiera
F Truelle acier
I Frattazzo
E Llana puntas redondas
CN 不锈钢砌墙刀



• made of special cold rolled stainless steel sheet with elasticity factor up to 2000 N/mm
• części robocze ze specjalnej zimnowalcowanej blachy nierdzewnej o sprężystości do 2000 N/mm

YATO	mm	
YT-5214	200x80	20

- GB Float with rubber for grouting
D Fliesen Fugbrett mit Softgummi
PL Paca z gumą do fugowania
RUS Тёрка с накладкой из губчатой резины
CZ Hladitko s gumou pro spárování
H Gumis simító fugázáshoz
- RO Gletieră din cauciuc pt. umplerea rosturilor
F Taloge avec gomme de jointeiment
I Pialletto con gomma per fughe
E Talocha con goma para juntas
CN 抹泥板



YATO	mm	
YT-51900	250x95	5

- GB Float with hydrorubber
D Fliesenwaschbrett mit Hydro-Schwamm
PL Paca z hydrogumą
RUS Тёрка с гидроумой
CZ Hladitko s hydrogumou
H Simító hidrogumival
- RO Burete hydrorubber
F Taloge avec hydrogomme
I Frattazzo con hydrogomma
E Talocha con hidrorrecubrimiento
CN 抹泥板



YATO	mm	
YT-51909	270x130	10

- GB Float with rubber
D Fliesenwaschbrett mit Zellgummiauflage
PL Paca z gumą
RUS Тёрка с резиновым покрытием
CZ Hladitko s gumou
H Gumis simító
- RO Gletieră din cauciuc
F Taloge avec couchou
I Pialletto con gomma
E Talocha con goma
CN 抹泥板



YATO	mm	
YT-51901	270x130	10

- GB Float with sponge SMPX
D Fliesenwaschbrett mit Schwamm SMPX
PL Paca z gąbką SMPX
RUS Тёрка с губкой SMPX
CZ Hladitko s houbou SMPX
H Simító szivaccsal SMPX
- RO Gletieră din spumă SMPX
F Taloge avec éponge SMPX
I Frattazzo con spugna SMPX scanalata
E Talocha con esponja renurada SMPX
CN 抹泥板



YATO	mm	
YT-51902	270x130	10

- GB Float with incised sponge SMPX
D Fliesenwaschbrett mit Schwamm SMPX Eingeschnitten
PL Paca z gąbką nacinaną SMPX
RUS Тёрка с надрезной губкой SMPX
CZ Hladitko s nařezávanou houbou SMPX
H Simító vágott szivaccsal SMPX
- RO Gletieră din burete cu model SMPX
F Taloge avec éponge entaillée SMPX
I Frattazzo con spugna SMPX scanalata
E Talocha con esponja renurada SMPX
CN 抹泥板



YATO	mm	
YT-51903	270x130	10

GB Float with thick sponge
D Fliesenwaschbrett mit dichtem Schwamm
PL Paca z gąbką gęstą
RUS Терка с плотной губкой
CZ Hladítko s hustou houbou
H Simitó súrú szivaccsal

RO Gletieră din burete dens
F Taloge avec éponge épaisse
I Frattazzo con spugna densa
E Talocha con esponja gruesa
CN 抹泥板



YATO mm
YT-51904 270x130 10

GB Float with thick and incised sponge
D Fliesenwaschbrett mit dichtem Schwamm eingeschnitten
PL Paca z gąbką gęstą nacinaną
RUS Терка с плотной нарезной губкой
CZ Hladítko s hustou narezávanou houbou
H Simitó súrú, vágott szivaccsal
CN 抹泥板

RO Gletieră din burete dens cu model
F Taloge avec éponge entaillée
I Frattazzo con spugna densa scanalata
E Talocha con esponja gruesa ranurada
CN 抹泥板



YATO mm
YT-51905 270x130 10

GB Float with gray sponge
D Fliesenwaschbrett mit feinem Schwamm grau
PL Paca z gąbką szarą
RUS Терка с серой губкой
CZ Hladítko s šedou houbou
H Simitó szürke szivaccsal

RO Gletieră din burete gri
F Taloge avec éponge grise
I Frattazzo con spugna grigia
E Talocha con esponja gris
CN 抹泥板



YATO mm
YT-51906 270x130 10

GB Float with gray sponge
D Fliesenwaschbrett mit feinem Schwamm grau
PL Paca z gąbką szarą
RUS Терка с серой губкой
CZ Hladítko s šedou houbou
H Simitó szürke szivaccsal

RO Gletieră din burete gri
F Taloge avec éponge grise
I Frattazzo con spugna grigia
E Talocha con esponja gris
CN 抹泥板



YATO mm
YT-51907 270x130 5

GB Float with porous sponge
D Fliesenwaschbrett mit porösen Schwamm
PL Paca z gąbką porowatą
RUS Терка с накладкой из микропористой резины
CZ Hladítko s pórovitou houbou

H Simitó porózus szivaccsal
RO Gletieră din burete poros
F Taloge avec éponge poreuse
I Frattazzo con spugna porosa
E Talocha con esponja porosa
CN 抹泥板



YATO mm
YT-51908 270x130 10

GB Float with felt
D Filz-Glättbrett
PL Paca z filcem
RUS Терка с накладкой из войлока
CZ Hladítko s filcem

H Simitó filccel
RO Gletieră cu păsă
F Taloge avec feutre
I Frattazzo con feltro
E Talocha con fieltro
CN 抹泥板



YATO mm
YT-51910 270x130 10

GB Plastic float
D Glättkelle PCV
PL Paca plastikowa
RUS Пластмассовая терка

CZ Plastové hladítko
H Műanyag simító
RO Gletieră din plastic
F Taloge en plastique

I Frattazzo in plastica
E Talocha en plástico
CN 抹泥板



YATO mm
YT-51911 270x130 20

GB Rasp for styrofoam
D Schleifbrett Reibebrett für Styropor
PL Tarnik do styropianu
RUS Терка для пенопласта
CZ Rašple na polystyren
H Reszelő polisztiréhez

RO Pieptene pt. polistiren expandat
F Taloge pour mousse de polystyrène
I Raspa per polistirolo
E Escofina para poliestireno
CN 多孔砂板



YATO mm
YT-51920 375x155 10

- GB Abrasive float "Rasp" type
 D Styropor-Schleibrett
 PL Pasa ścierna do styropianu
 RUS Шлифовальная тёрка "рашпиль"
 CZ Škrabák na porobeton
 H Csizsoló polystirol habhoz
 RO Gletiera abraziva
 F Flotteur abrasif à styrofoam
- I Frattazzo abrasivo
 E Liana abrasiva para polietileno
 CN 磨砂型砌墙刀



YATO	mm	
YT-5218	165x370	20

- GB Stripping knife
 D Flächenspachtel
 PL Szpachla fasadowa
 RUS Стальной шпатель
 CZ Štěrka fasádní
 H Spatulya falí (rákli)
 RO Spaclu inox
 F Spatule inoxydable
- I Spatola per facciata
 E Espátula de fachada
 CN 剥皮刀



YATO	mm	
YT-5226	250	20
YT-5228	350	20
YT-5230	500	20

• made of special cold rolled stainless steel sheet with elasticity factor up to 2000 N/mm
 • części robocze ze specjalnej zimnowalcowanej blachy nierdzewnej o sprężystości do 2000 N/mm

- GB Triangular trowel
 D Maurerkelle
 PL Kielnia trójkątna
 RUS Треугольный мастерок
 CZ Lžíce trojúhelníková
 H Kőműves kanál háromszögletű
 RO Mistrie triunghi
 F Truelle
 I Cazzuola punta triangolare
 E Paleta triangular
 CN 不锈钢砌墙刀



YATO	mm	
YT-5234	200x190	10

• made of special cold rolled stainless steel sheet with elasticity factor up to 2000 N/mm
 • części robocze ze specjalnej zimnowalcowanej blachy nierdzewnej o sprężystości do 2000 N/mm

- GB Trapezoid trowel
 D Stukkateurkelle
 PL Kielnia trapezowa
 RUS Трапецидальный мастерок
 CZ Lžíce zednická
 H Kőműves kanál rozsdamentes
 RO Mistrie
 F Truelle trapézoïdale
 I Cazzuola punta trapezio
 E Paleta trapezoidal
 CN 不锈钢砌墙刀



YATO	mm	
YT-5237	120x180x80	10

• made of special cold rolled stainless steel sheet with elasticity factor up to 2000 N/mm
 • części robocze ze specjalnej zimnowalcowanej blachy nierdzewnej o sprężystości do 2000 N/mm

- GB Trapezoid trowel
 D Stukkateurkelle
 PL Kielnia trapezowa
 RUS Трапецидальный мастерок
 CZ Lžíce zednická
 H Kőműves kanál rozsdamentes
 RO Mistrie
 F Truelle trapézoïdale
 I Cazzuola punta trapezio
 E Paleta trapezoidal
 CN 不锈钢砌墙刀



YATO	mm	
YT-5240	165x80x55	20

• made of special cold rolled stainless steel sheet with elasticity factor up to 2000 N/mm
 • części robocze ze specjalnej zimnowalcowanej blachy nierdzewnej o sprężystości do 2000 N/mm

- GB Stucco trowel
 D Gipserspachtel
 PL Kielnia „Podkowa”
 RUS Штукатурный мастерок
 CZ Lžíce vymazávací
 H Gittelő kanál rozsdamentes
 RO Mistrie
 F Truelle en stuc
 I Cazzuola punta tonda
 E Paleta para estucado
 CN 不锈钢砌墙刀



YATO	mm	
YT-5242	100x130	20
YT-5243	80x110	20

• made of special cold rolled stainless steel sheet with elasticity factor up to 2000 N/mm
 • części robocze ze specjalnej zimnowalcowanej blachy nierdzewnej o sprężystości do 2000 N/mm

- GB Stucco sharp trowel
 D Putzkelle
 PL Kielnia ostra
 RUS Кельма заостренная треугольная
 CZ Lžíce pokrývačská
 H Gittelő kanál rozsdamentes
 RO Mistrie cu cioc ascutit
 F Truelle
 I Cazzuola punta acuta
 E Paleta pontiaguda
 CN 不锈钢砌墙刀



YATO	mm	
YT-5245	135x80	20

• made of special cold rolled stainless steel sheet with elasticity factor up to 2000 N/mm
 • części robocze ze specjalnej zimnowalcowanej blachy nierdzewnej o sprężystości do 2000 N/mm

- GB Plaster scrubber
 D Alu-Rabott
 PL Zdzierak do tynków
 RUS Треугольный мастерок для каменщиков
 CZ Škrabák
 H Vakolat gyalu alu késes
 RO Gletiera abraziva
 F Enleveur du badigeon
 I Utensile per sgrossare
 E Rascador para enlucido
 CN 石膏去除器



YATO	mm	
YT-52471	248x133	10

GB Scraper for plaster and aerated blocks
D Gipsobel mit Stahlklingen
PL Zdzierak wyrównujący
RUS Выравнивающий рашпиль
CZ Vyrovnávací škrabák
H Kiegyenlítő kaparó
RO Răspel de nivelare

F Lime grosse droit
I Raschiatore livellatore
E Desbastador para nivelar la superficie
CN 干墙器



YATO mm
YT-52472 405x84 10

GB Scraper with teeth for plaster and aerated blocks

D Gipsobel mit Stahlklingen gezahnt
PL Zdzierak wyrównujący z ząbkami
RUS Выравнивающий рашпиль с зубцами
CZ Vyrovnávací škrabák se zoubky
H Kiegyenlítő kaparó fogakkal

RO Răspel cu dinți
F Lime grosse droit avec dents
I Raschiatore livellatore dentato
E Desbastador dentado para nivelar la superficie
CN 干墙器



YATO mm
YT-52473 405x84 10

GB Plaster scrubber
D Alu-Rabott
PL Zdzierak do tynków
RUS Треугольный мастерок для каменщиков
CZ Škrabák
H Vakolat gyalu alu késes
RO Gletiera abraziva
F Enleveur du badigeon
I Utensile per sgrassare
E Rascador para enlucido
CN 石膏去除器



YATO mm
YT-5247 450x90 25

AI

GB Mortar gun with nozzles kit
D Mörtelspritze
PL Wyciskacz do fugowania

RUS Пистолет для затирки швов
CZ Pistole vytačovací
H Kinyomó pisztoly

RO Pistol pt. silicon
F Seringue mortier
I Pistola per silicone

E Pistola para calafatear mortero
CN 堵缝枪



YATO
YT-67580 10



YATO
YT-67583 12

13

GB Wallboard carrier
D Plattenträger mit Tragegriff
PL Uchwyt do noszenia płyt gipsowo-kartonowych
RUS Приспособление для переноски плит
CZ Držák pro přenášení desek s rukojetí
H Jellemzők és előnyök
RO Dispositiv pt. transportat plac de gips-carton
F Porte-plaques a griffes
I Impugnatura porta lastre in cartongesso
E Empunadura porta-placas
CN 石膏板提取器

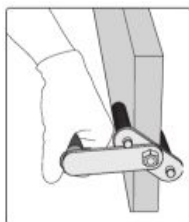

YATO
YT-37440 2/12

GB Panel carry
D Plattenträger mit Tragegriff
PL Nosido do płyt gipsowo-kartonowych
RUS Приспособление для переноски плит
CZ Držák pro přenášení desek s rukojetí
H Gipszkarton hordó
RO Dispositiv pt. transportat plac de gips-carton
F Poignée transport de plaque
I Porta lastre in cartongesso
E Porta-paneles
CN 石膏板提手



YATO max. lifting capacity / max. udźwig (kg)
YT-37444 80 12

80 kg (max)
ABS

POLYBAG

GB Drywall board lifter
D Hebel zu platten fortragen
PL Aluminiowa dźwignia do unoszenia płyt gipsowo-kartonowych
RUS Приспособление для поднятия листов гипсокартона и отделочных панелей
CZ Páka pre zdvihacie plošiny
H Gipszkarton emelő
RO Elevator de picior
F Levier a panneau
I Sollevatore in alluminio per lastre
E Levanta paneles
CN 石膏板起板器

HANGING COLOR BOX



55 mm LIFTING CAPACITY (maks. udźwig)
AI



YATO
YT-37450 10

GB Aluminium try square
 D Anschlagwinkel
 PL Kałownik do płyt gipsowo-kartonowych
 RUS Угольник столярный
 CZ Truhlářský úhelník černý
 H Asztalos derékszög, fekete
 RO Echer de tâmplărie negru
 F Équerre
 I Squadra per pannelli in gesso
 E Escuadra de aluminio
 CN T型角尺



1200 mm

+/- 0.03 mm

Al

YATO YT-70855 10

GB Edge planing machine for gypsum plate
 D Gipskartonhobel
 PL Strug do krawędzi płyt gipsowo-kartonowych
 RUS Рубанок кромочный для гипскартона
 CZ Sádrokarton hoblak
 H Élgyalu gipszkartonhoz
 RO Dispozitiv slefuit, sanfreant gips carton
 F Placoplâtre raboteuse
 I Piatta per bordi per lastre in cartongesso
 E Cepillo biselador carton yeso
 CN 塑料刨边器

9.5-15 mm

2 BLADES OSTRZA



COLOR BOX

YATO YT-76260 10/60

GB Drywall stripper
 D Streifen Schneider
 PL Obcinak dwustronny do płyt gipsowo-kartonowych
 RUS Рейсмус-резаk для гипсокартона
 CZ Řezák na sádrokarton
 H Gipszkarton-vágó
 RO Dispozitiv reglabil de taiere a placilor de gips-carton
 F Outil coupe cloison sèche
 I Taglierino reversibile per pannelli in cartongesso
 E Cortador de tiras para tablaroca
 CN 石膏板割刀

DOUBLE BLISTER



2x Ø 38 mm

DOUBLE SIDED DWUSTRONNY



YATO YT-76266 12

GB Telescopic support bar
 D Baustütze-Schnellspannstütze
 PL Podpora teleskopowa
 RUS Подъемник-распорка для гипсокартона
 CZ Tuč teleskopická rozpěrná
 H Teleszkópos támasztórúd
 RO Suport sustinere telescopic
 F Presse extensible
 I Supporto telescopico
 E Puntal expansion
 CN 伸缩顶杆



115 cm
60 cm

YATO YT-64551 6



290 cm
125 cm

YATO YT-64552 6



30kg max.

POLYBAG

GB Pliers for hollow expansion bolts
 D Maueranker-Einsetzwerkzeug
 PL Zaciskarka do kołków „Molly”
 RUS Клещи для дюбелей „Молли”
 CZ Kotvící kleště
 H Kreater üreges fémdübel
 RO Set cleste dibluri
 F Pince pour chevilles creux
 I Crimpatrice per pioli „Molly”
 E Alicata para tacos „Molly”
 CN 膨胀螺栓钳组套

175 mm



DOUBLE BLISTER

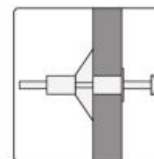

YATO YT-51452 L (mm) 175 5/30

GB Pliers for hollow expansion bolts
 D Maueranker-Einsetzwerkzeug Satz
 PL Zaciskarka do kołków „Molly”
 RUS Клещи для дюбелей „Молли”
 CZ Kotvící kleště
 H Kreater üreges fémdübel

RO Set cleste dibluri
 F Pince pour chevilles creux
 I Crimpatrice per pioli „Molly”
 E Alicata para tacos „Molly”
 CN 膨胀螺栓钳组套

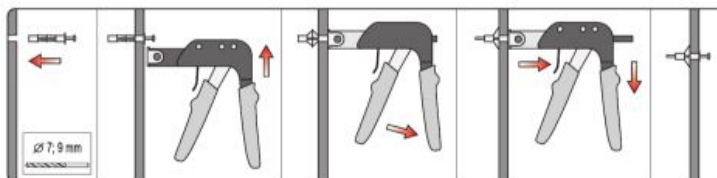

5x Ø 7 mm (32 mm)
 5x Ø 9 mm (37 mm)
 Ø 4 mm (40 mm)
 Ø 5 mm (44 mm)

10 pcs

YATO YT-51450 6/24

35x Ø 7 mm (32 mm)
 10x Ø 9 mm (52 mm)
 15x Ø 9 mm (37 mm)
 Ø 4 mm (40 mm)
 Ø 5 mm (58 mm)
 Ø 5 mm (44 mm)

DOUBLE BLISTER

60 pcs

YATO YT-51451 3/12



PLASTIC BOX

GB Tin snips
D Blechscherer
PL Nożyce do cięcia blachy

RUS Ножницы по металлу
CZ Nůžky na plech
H Lemezvágó olló

RO Foarfece pt. tablă
F Cisaille à tôle
I Cesioie per lamiere

E Tijeras para chapas
CN 铁皮剪

SLIDING
CARD



LEFT
CUT
CIECIE
LEWE

CrMo

INCREASED
CUTTING
POWER
ZWIĘKSZONA
SIŁA CIĘCIA

HRC
60-62

DIN
6438



YATO	L (mm)	cutting length (mm)	cutting capacities (mm)				6/36
			copper	cold-rolled steel	hard steel HRC35	stainless steel 304	
YT-1910	260	35	1.80	1.50	1.00	0.90	6/36

HRC
60-62

DIN
6438



YATO	L (mm)	cutting length (mm)	cutting capacities (mm)				6/36
			copper	cold-rolled steel	hard steel HRC35	stainless steel 304	
YT-1915	235	30	1.50	1.20	1.00	0.70	6/36

HRC
60-62

DIN
6438



YATO	L (mm)	cutting length (mm)	cutting capacities (mm)				6/36
			copper	cold-rolled steel	hard steel HRC35	stainless steel 304	
YT-1918	260	32	1.80	1.50	1.00	0.90	6/36

HRC
56-62

SEPARATED
EDGES
ZARÓDKOWANA
KRAWĘDZ
OSTROCY

HIGH
FREQUENCY
HARDENING
HARTOWANIE
IMPULSOWE



YATO	L (mm)	cutting length (mm)	cutting capacities (mm)				6/36
			copper	cold-rolled steel	hard steel HRC35	stainless steel 304	
YT-1960	250	40	2.00	1.50	1.00	0.80	6/36

GB Tin snips
D Blechscherer
PL Nożyce do cięcia blachy
RUS Ножницы по металлу
CZ Nůžky na plech
H Lemezvágó olló
RO Foarfece pt. tablă
F Cisaille à tôle
I Cesioie per lamiere
E Tijeras para chapas
CN 铁皮剪



LEFT
CUT
CIECIE
LEWE

HRC
60-62

CrMo

90°

SEPARATED
EDGES
ZARÓDKOWANA
KRAWĘDZ
OSTROCY



SLIDING
CARD



YATO	L (mm)	cutting length (mm)	cutting capacities (mm)				6/36
			copper	cold-rolled steel	hard steel HRC35	stainless steel 304	
YT-1913	225	30	0.78	0.53	0.46	0.36	6/36

13

GB Tin snips
D Blechscherer
PL Nożyce do cięcia blachy

RUS Ножницы по металлу
CZ Nůžky na plech
H Lemezvágó olló

RO Foarfece pt. tablă
F Cisaille à tôle
I Cesioie per lamiere

E Tijeras para chapas
CN 铁皮剪

SLIDING
CARD



STRAIGHT
CUT
CIECIE
PROSTE

CrMo

INCREASED
CUTTING
POWER
ZWIĘKSZONA
SIŁA CIĘCIA

HRC
60-62

DIN
6438



YATO	L (mm)	cutting length (mm)	cutting capacities (mm)				6/36
			copper	cold-rolled steel	hard steel HRC35	stainless steel 304	
YT-1912	260	35	1.80	1.50	1.00	0.90	6/36

HRC
60-62

DIN
6438



YATO	L (mm)	cutting length (mm)	cutting capacities (mm)				6/36
			copper	cold-rolled steel	hard steel HRC35	stainless steel 304	
YT-1922	290	75	1.10	0.94	0.70	0.53	6/36

HRC
60-62

DIN
6438



YATO	L (mm)	cutting length (mm)	cutting capacities (mm)				6/36
			copper	cold-rolled steel	hard steel HRC35	stainless steel 304	
YT-1923	230	25	2.00	1.60	1.20	1.20	6/36

HRC
56-62

SEPARATED
EDGES
ZARÓDKOWANA
KRAWĘDZ
OSTROCY

HIGH
FREQUENCY
HARDENING
HARTOWANIE
IMPULSOWE



YATO	L (mm)	cutting length (mm)	cutting capacities (mm)				6/36
			copper	cold-rolled steel	hard steel HRC35	stainless steel 304	
YT-1962	250	45	2.00	1.50	1.00	0.80	6/36

GB Tin snips
D Blechscherer
PL Nożyce do cięcia blachy

RUS Ножницы по металлу
CZ Nůžky na plech
H Lemezvágó olló

RO Foarfece pt. tablă
F Cisaille à tôle
I Cesioie per lamiere

E Tijeras para chapas
CN 铁皮剪

SLIDING CARD



RIGHT CUT
CIECIE
PRAWIE

CrMo

INCREASED CUTTING POWER
WZROKONIONA SIŁA CIĘCIA

HRC 60-62

DIN 6438



HRC 60-62

DIN 6438



YATO	L (mm)	cutting length (mm)	cutting capacities (mm)				6/36
			copper	cold-rolled steel	hard steel HRC35	stainless steel 304	
YT-1911	260	35	1.80	1.50	1.00	0.90	6/36

YATO	L (mm)	cutting length (mm)	cutting capacities (mm)				6/36
			copper	cold-rolled steel	hard steel HRC35	stainless steel 304	
YT-1916	235	30	1.50	1.20	1.00	0.70	6/36

HRC 60-62

DIN 6438



HRC 56-62

SEPARATED EDGES
ZARÓDKOWANA KRAWĘDZ
OSTRZY

HIGH FREQUENCY HARDENING
HARTOWANIE
IMPULSOWE



YATO	L (mm)	cutting length (mm)	cutting capacities (mm)				6/36
			copper	cold-rolled steel	hard steel HRC35	stainless steel 304	
YT-1919	260	32	1.80	1.50	1.00	0.90	6/36

YATO	L (mm)	cutting length (mm)	cutting capacities (mm)				6/36
			copper	cold-rolled steel	hard steel HRC35	stainless steel 304	
YT-1961	250	40	2.00	1.50	1.00	0.80	6/36

GB Tin snips
D Blechscherer
PL Nożyce do cięcia blachy
RUS Ножницы по металлу
CZ Nůžky na plech
H Lemezvágó olló

RO Foarfece pt. tablă
F Cisaille à tôle
I Cesioie per lamiere
E Tijeras para chapas
CN 铁皮剪

RIGHT CUT
CIECIE
PRAWIE

HRC 60-62

CrMo

90°

SEPARATED EDGES
ZARÓDKOWANA KRAWĘDZ
OSTRZY



SLIDING CARD



YATO	L (mm)	cutting length (mm)	cutting capacities (mm)				6/36
			copper	cold-rolled steel	hard steel HRC35	stainless steel 304	
YT-1914	225	30	0.78	0.53	0.46	0.36	6/36

13

GB Tin snips
D Blechscherer
PL Nożyce do cięcia blachy
RUS Ножницы по металлу

CZ Nůžky na plech
H Lemezvágó olló
RO Foarfece pt. tablă
F Cisaille à tôle

I Cesioie per lamiere
E Tijeras para chapas
CN 铁皮剪

SLIDING CARD



LEFT CUT
CIECIE
LEWIE

DROP FORGED
KUTE

HRC 58-61



YATO	L (mm)	cutting length (mm)	cutting capacities (mm)				6/24
			copper	cold-rolled steel	hard steel HRC35	stainless steel 304	
YT-1900	260	30	0.94	0.78	0.60	0.45	6/24

GB Tin snips
D Blechscherer
PL Nożyce do cięcia blachy
RUS Ножницы по металлу

CZ Nůžky na plech
H Lemezvágó olló
RO Foarfece pt. tablă
F Cisaille à tôle

I Cesioie per lamiere
E Tijeras para chapas
CN 铁皮剪

SLIDING CARD



RIGHT CUT
CIECIE
PRAWIE

DROP FORGED
KUTE

HRC 58-61



YATO	L (mm)	cutting length (mm)	cutting capacities (mm)				6/24
			copper	cold-rolled steel	hard steel HRC35	stainless steel 304	
YT-1901	260	30	0.94	0.78	0.60	0.45	6/24



YATO	L (mm)	cutting length (mm)	cutting capacities (mm)				6/24
			copper	cold-rolled steel	hard steel HRC35	stainless steel 304	
YT-1902	300	50	0.94	0.78	0.60	0.45	6/24

- GB Tin snips
D Blechscherer
PL Nożyce do cięcia blachy
RUS Ножницы по металлу
CZ Nůžky na plech
H Lemezvágó olló
RO Foarfece pt. tablă
F Cisaillie à tôle
I Cesiole per lamiera
E Tijeras para chapas
CN 铁皮剪

SLIDING CARD



YATO	L (mm)	cutting length (mm)	cutting capacities (mm)				6/36
			copper	cold-rolled steel	hard steel HRC35	stainless steel 304	
YT-1970	260	42	2.0	1.4	1.0	1.0	6/36

STRAIGHT CUT
CIĘCIE PROSTE
HRC 58-61
DROP FORGED KUTE

- GB Tin snips
D Blechscherer
PL Nożyce do cięcia blachy
RUS Ножницы по металлу
CZ Nůžky na plech
H Lemezvágó olló

- RO Foarfece pt. tablă
F Cisaillie à tôle
I Cesiole per lamiera
E Tijeras para chapas
CN 铁皮剪

SLIDING CARD



For cutting straight and light curves left or right



YATO	L (mm)	cutting length (mm)	cutting capacities (mm)				6/36
			copper	cold-rolled steel	hard steel HRC35	stainless steel 304	
YT-1925	225	52	0.94	0.78	0.60	0.45	6/36

HRC 58-60



YATO	L (mm)	cutting length (mm)	cutting capacities (mm)				6/36
			copper	cold-rolled steel	hard steel HRC35	stainless steel 304	
YT-1920	260	42	1.20	1.00	0.60	0.50	6/36

- GB Tin snips
D Blechscherer
PL Nożyce do cięcia blachy
RUS Ножницы по металлу
CZ Nůžky na plech
H Lemezvágó olló
RO Foarfece pt. tablă
F Cisaillie à tôle
I Cesiole per lamiera
E Tijeras para chapas
CN 铁皮剪



SLIDING CARD



For cutting straight and light curves left or right

HRC 58-61

YATO	L (mm)	cutting length (mm)	cutting capacities (mm)				6/36
			copper	cold-rolled steel	hard steel HRC35	stainless steel 304	
YT-1924	254	52	0.94	0.78	0.60	0.45	6/36

- GB Tin snips
D Blechscherer
PL Nożyce do cięcia blachy
RUS Ножницы по металлу
CZ Nůžky na plech
H Lemezvágó olló
RO Foarfece pt. tablă
F Cisaillie à tôle

- I Cesiole per lamiera
E Tijeras para chapas
CN 铁皮剪



SLIDING CARD



YATO	L (mm)	cutting length (mm)	cutting capacities (mm)				6/36
			copper	cold-rolled steel	hard steel HRC35	stainless steel 304	
YT-1963	200	40	1.5	1.0	0.6	0.6	6/36
YT-1964	250	60	1.8	1.2	0.8	0.8	6/24
YT-1965	300	75	2.0	1.4	0.8	0.8	6/12

- GB Metal sheet nibbler
D Blechnibbler
PL Nożyce matrycowe do blachy
RUS Ножницы для резки жести
CZ Nůžky na plech
H Lemezvágó olló

- RO Foarfece pt. tablă
F Grignoteuse a tole
I Cesioia roditrice per lamiera
E Tijeras para chapas
CN 法式剪



HALF DOUBLE BLISTER



- GB Spare blades for metal sheet nibbler
D Abbrechklingen für Blechnibbler
PL Ostrza zapasowe do nożyc matrycowych
RUS Лезвия для ножниц для резки жести
CZ Ostrří náhradní
H Tartalékpenge

- RO Lame de rezervă
F Lame sécables pour grignoteuse a tole
I Lame di ricambio per cesioia roditrice per lamiera
E Cuchillas de recambio
CN 法式剪备用刀片

3 PCS

Mn 65



SKIN CARD



for / dla:
YT-19260

YATO	L (mm)	6/36
YT-19260	260	6/36

YATO	10/100
YT-19261	10/100

- GB** Portable notchers
D Schere zum Ausschneiden von Ecken
PL Nożyce do wycinania naroży
RUS Ножницы для наружных углов
CZ Nůžky na vystřihování rohů
H Sarokkivágó olló
RO Foarfece pt. taierea colturilor
F Ciseaux pour le coupage des coins
I Cesioie per taglio reggetta in angoli
E Tijera para esquinas
CN 截角器

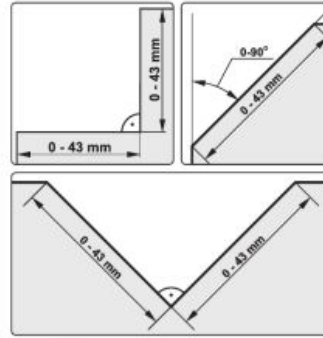

300 mm 90°



YATO	L (mm)	
YT-1939	300	15

- GB** Hand notchers
D Kerbzange
PL Nożyce dekarские do nacinania blach
RUS Ножницы v-образные
CZ Nůžky na plech vystřihování rohů
H Lemezvágó olló

- RO** Foarfece tabla taiere colturi
F Ciseaux à tôle
I Cesioie per lamiera

- E** Cizallas para techos
CN 缺口钳



230 mm 30° CrV



YATO	L (mm)	
YT-18970	230	6/36

- GB** Nail hole slot punch
D Langlochzange
PL Szczypce do sidingu do podłużnych otworów montażowych
RUS Клещи для пробивки продольных отверстий
CZ Klempříské kleště prostřihovací - oválné otvory

- H** Lyukasztó fogó vágó
RO Clește pt. perforare - găuri ovale
F Pince à poinçonner en oblong
I Pinze per pannelli profilati per fori di montaggio oblunghi

- E** Canteadeira conjugada com furador ovóide
CN 腰型打孔钳

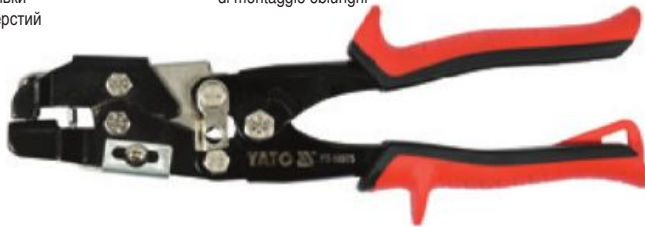

240 mm 15 x 3.5 mm CrV



YATO	L (mm)	
YT-18975	240	6/36

- GB** Snap lock punch
D Schnappverschluss-Lochtreiber
PL Zaciskacz punktowy
RUS Плоскогубцы для кровельщиков
CZ Střešní kleště

- H** Tetőfedő fogó
RO Clește pt. despiciat
F Pincés pour couvreurs

- I** Pinza a cimpare
E Punzón de cerradura de resorte
CN 记号钳



230 mm CrV



YATO	L (mm)	
YT-18977	230	6/36

- GB** Straight pliers
D Zange zum Blechbiegen
PL Kleszcze do gięcia blach
RUS Клещи с тупым ножом для жести
CZ Kleště na ohýbání plechu
H Falcfogó
RO Cleste pt. indoirea tablei
F Pince à fléchir la tôle
I Taglie per la lamiera

- E** Tenazas para doblar hojalata
CN 钣金钳



45° 55 mm



90° 55 mm



180° 55 mm

COLOR BOX



YATO	L (mm)		YATO	L (mm)		YATO	L (mm)	
YT-5416	280	10/20	YT-5417	260	10/20	YT-5415	280	10/20

GB Single seam clench
D Klemme für Einfachfalz
PL Zaciskacz rąbka pojedynczego
RUS Зажим отдельного фальца
CZ Uzavírač jednoduché drážky
H Falclezáró fogó
RO Clema pt. falt simplu
F Plieur manuel tôle (rebord singulier)
I Griffa
E Pinza para costura individual
CN 屋顶施工工具

GB Double seam clench
D Klemme für Doppelfalz
PL Zaciskacz rąbka podwójnego
RUS Зажим двойного фальца
CZ Uzavírač dvojité drážky
H Duplafalclezáró fogó
RO Clema pt. falt dublu
F Plieur manuel tôle (rebord double)
I Griffa
E Pinza para costura doble
CN 屋顶施工工具

GB Eaves turner
D Kantvorrichtung für Dachtraufe
PL Kantownik okapu
RUS Угольник навеса
CZ Ohýbačka okapnice
H Ereszperemező fogó
RO Cornier streasina
F Cintreuse d'avant-toit
I Griffa
E Volteador de alero
CN 屋顶施工工具

GB Eaves clench
D Klemme für Dachtraufe
PL Zaciskacz okapu
RUS Зажим навеса
CZ Uzavírač okapnice
H Ereszváró fogó
RO Clema pt. streasina
F Cintreuse d'avant-toit
I Griffa
E Pinza para alero
CN 屋顶施工工具



YATO	Ø (mm) pipe / rurki	mm	
YT-5400	18	480x220	5

YATO	Ø (mm) pipe / rurki	mm	
YT-5402	18	480x220	5

YATO	Ø (mm) pipe / rurki	mm	
YT-5404	18	450x200	5

YATO	Ø (mm) pipe / rurki	mm	
YT-5405	18	450x200	5

GB Drainpipe hooks bender
D Biegewerkzeug für Dachrinnenhaken
PL Zaginacz haków rynnowych
RUS Прибор для загибання крюков
для водосточных желобов
CZ Ohýbačka okapových háků
H Ereszcsatorna-tartóvas hajlító
RO Dispozitiv pt. îndoit cârlige burlan
F Cintreuse pour crochets de gouttière
I Utensile per gancio
E Herramienta para doblar
los ganchos para canalones
CN 弯管器



YATO	L (mm)	
YT-5410	680	4

GB Pipe crimper
D Rohreinziehzange mit 5 Klingen
PL Szczypce do karbowania rur
RUS Клещи „гофра”
прямые усиленные
CZ Kleště křepované
H Kreppelő kullancsok
RO Clește gofrare burlane
F Pince a gaufrer 5 lames
I Pinza per corrugare tubi
E Crimpadora de tubos
CN 波浪剪



HALF DOUBLE
BLISTER



260
mm

LOCK
SYSTEM
BLOKADY

YATO	L (mm)	
YT-22380	260	6/36

- GB Wire tying twister hook
 D Rödeldraht-Drillkurbel
 PL Klucz do wiązania drutu zbrojeniowego
 RUS Крючок для вязки арматуры
 CZ Radlovačka
 H Huzalsodró
 RO Dispozitiv pt. legat fier beton
 F Lieur
 I Gancio per legare armature
 E Gancho para amarrar alambre
 CN 钢筋钩

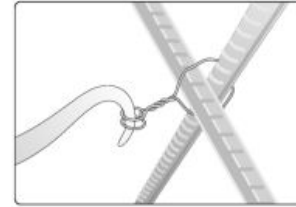

YATO	L (mm)	
YT-54230	210	10/100

210 mm

SLIDING CARD



- GB Automatic twister hook for wire tying
 D Rödeldraht-Drillkurbel
 PL Klucz automatyczny do skręcania drutu
 RUS Автоматический крюк для вязки арматуры
 CZ Spirálový vazač
 H Huzalsodró készülék
- RO Dispozitiv automat pt. legat fier beton
 F Lieur automatique
 I Torcifilo automatico
 E Gancho para amarrar alambre automatico
 CN 自动伸缩钢筋钩

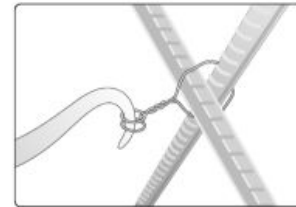

YATO	L (mm)	
YT-54233	300	10/30

300 mm

- GB Rectangular floating rule
 D Setzlatte 2 Libellen
 PL Łata murarska
 RUS Правило-уровень
- CZ Lat' zednická s libelami
 H Ólesléc, téglalap keresztmetszetű
 RO Dreptar cu 2 bule
 F Niveau à bulle
- I Livella
 E Nivel de albañil
 CN 刮板



ACCURACY
0.05"
= 1 mm/m

2 PRECISION VIALS
LIBELLE

YATO	L (mm)	
YT-3071	1500	10
YT-3072	2000	10
YT-3073	2500	10
YT-3074	3000	10

COLOR SLEEVE

13



YATO	L (mm)	
YT-3076	1500	10
YT-3077	2000	10
YT-3078	2500	10
YT-3079	3000	10

- GB Trapezoid floating rule
 D Abziehlatte mit Trapezprofil
 PL Łata tynkarska
 RUS Правило трапециевидное
- CZ Lat' mališská
 H Ólesléc, trapézoid keresztmetszetű
 RO Dreptar trapezoidal
 F Niveau à bulle
- I Livella trapezoidale
 E Nivel de albañil
 CN 梯形刮板



COLOR SLEEVE

YATO	L (mm)	
YT-3081	1500	10
YT-3082	2000	10
YT-3083	2500	10
YT-3084	3000	10

- GB Knife for roofing paper
 D Messer zum Schneiden von Pappe
 PL Nóż do cięcia papy
 RUS Нож для резки рубероида
 CZ Nůž k řezání lepenky
 H Kátrányapapírvágó olló
 RO Cutter pt. tăierea cartonului asfaltat
 F Couteau pour carton
 I Coltello per tagliare cartone bituminoso
 E Cuchilla para cortar cartón alquitranado
 CN 多功能刀



SLIDING CARD



90 mm
 SS
 STAINLESS STEEL
 ÉTEL KÉSZLETT

YATO	L (mm)	
YT-7620	230	12/60

GB Knife for mineral wool
D Messer zum Schneiden von Bausolierungen
PL Nóż do cięcia izolacji budowlanych
RUS Нож для резки строительной изоляции

CZ Nůž k řezání stavebních izolačních hmot
H Kés épületszigetelés vágásához
RO Cutter pt. tăierea izolațiilor
F Couteau pour isolants

I Coltello per tagliare l'isolamento di costruzione
E Cuchilla para cortar aislamiento de construcción
CN 多功能刀

SLIDING
CARD



YATO	L (mm)	
YT-7623	500	10/50



YATO	L (mm)	
YT-7624	480	10/50

GB Thermal knife for polystyrene foam
D Thermomesser für Styropor
PL Nóż termiczny do styropianu
RUS Термонож для пенопласта

CZ Termický nůž na pěnový polystyrén
H Polisztirol vágó hőkés
RO Cuițit termic pt. stiropian
F Couteau thermique à styrofoam

I Coltello termico per polistirolo
E Cuchilla térmica para poliestireno
CN 热切割刀

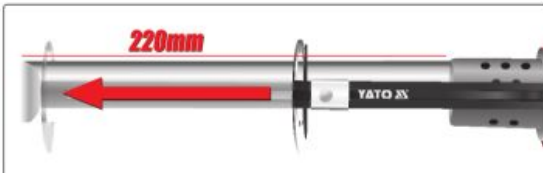
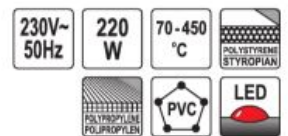

COLOR BOX



YATO	W	L (mm)	
YT-82190	220	220	10

GB Electric hoist
D Elektro-Seilwinde
PL Elektryczny wciągnik linowy
RUS Электрическая канатная лебедка
CZ Elektrický naviják kladkostroj
H Elektromos csőrőlő
RO Troliu electric cu cablu
F Treuil électrique à corde
I Verricello elettrico
E Cabria eléctrica de cuerdas
CN 电动葫芦



COLOR BOX



YATO	W	
500 W	125 kg	250 kg
YT-5901	500	2

$L_{PA} \leq 70$ dB;
 $L_{WA} \leq 85$ dB

YATO	W	
550 W	150 kg	300 kg
YT-5902	550	2

$L_{PA} \leq 70$ dB;
 $L_{WA} \leq 85$ dB

YATO	W	
900 W	250 kg	500 kg
YT-5904	900	2

$L_{PA} \leq 70$ dB;
 $L_{WA} \leq 85$ dB

YATO	W	
1050 W	300 kg	600 kg
YT-5905	1050	2

$L_{PA} \leq 70$ dB;
 $L_{WA} \leq 85$ dB

- GB Rubber protection extension cord
- D Gummiisolierte Verlängerungsschnur
- PL Przedłużacz w osłonie gumowej
- RUS Удлинитель с резиновой изоляцией
- CZ Prodlužovací kabel s gumovou izolací
- H Gumi szigetelésű hosszabbító
- RO Cablu prelungitor cauciuc
- F Rallonge électrique
- I Prolunga in gomma
- E Cable de extensión con protección de caucho
- CN 电缆延长线



CABLE 3G1.5
H05RR-F mm²
KABEL CABLE / KABEL



CABLE 3G2.5
H05RR-F mm²
KABEL CABLE / KABEL

IP44 16A
E & F TYPE / TYP E TYPE / TYP
230V~50Hz



COLOR BOX

YATO	L (m)	
YT-81021	10	8
YT-81022	20	4
YT-81023	30	4
YT-81024	40	2

YATO	L (m)	
YT-8100	20	4
YT-8101	30	2
YT-8102	40	2



CABLE 3G1.5
H07RN-F mm²
KABEL CABLE / KABEL



CABLE 3G1.5
H07RN-F mm²
KABEL CABLE / KABEL

YATO	L (m)	
YT-8111	5	16
YT-8112	10	8

YATO	L (m)	
YT-8116	10	4
YT-81162	20	4

- GB Cable reel
- D Kabeltrommel
- PL Przedłużacz zwijany
- RUS Удлинитель электрический барабанного типа
- CZ Bubnový prodlužovač
- H Kábeldob
- RO Prelungitor pe tambur
- F Rallonge électrique sur tambour enrouleur
- I Avvolgicavo con bobina
- E Cable de prolongación de tambor
- CN 电缆延长线

IP44 16A
CABLE 3G1.5
H05RR-F mm²
KABEL CABLE / KABEL
E & F TYPE / TYP E TYPE / TYP
230V~50Hz



- P_{max} = 1000 W coiled
- P_{max} = 1000 W zwinięty
- P_{max} = 3000 W uncoiled
- P_{max} = 3000 W rozwinięty

POLYBAG

YATO	L (m)	
YT-81052	20	2
YT-81053	30	2
YT-81054	40	2

- GB Cable reel
- D Kabeltrommel
- PL Przedłużacz zwijany
- RUS Удлинитель электрический барабанного типа
- CZ Bubnový prodlužovač
- H Kábeldob
- RO Prelungitor pe tambur
- F Rallonge électrique sur tambour enrouleur
- I Avvolgicavo con bobina
- E Cable de prolongación de tambor
- CN 电缆延长线

IP44 16A
CABLE 3G2.5
H05RR-F mm²
KABEL CABLE / KABEL
E & F TYPE / TYP E TYPE / TYP
230V~50Hz



- P_{max} = 1200 W coiled
- P_{max} = 1200 W zwinięty
- P_{max} = 3600 W uncoiled
- P_{max} = 3600 W rozwinięty

POLYBAG

YATO	L (m)	
YT-8106	30	1
YT-8107	40	1
YT-8108	50	1

- GB Drum power extension cord
- D Verlängerungstrommel für Kraftstrom
- PL Przedłużacz bębnowy siłowy
- RUS Силовой удлинитель барабанного типа
- CZ Prodlužovací kabel silový na bubnu
- H Háromfázisú hosszabbító dob
- RO Derulator cu tambur
- F Rallonge électrique sur tambour enrouleur
- I Avvolgicavo di forza
- E Cilindro de extensión de fuerza
- CN 电缆延长线

IP44 16A
CABLE 5G2.5
H07RN-F mm²
KABEL CABLE / KABEL
3P+N+E 3P+N+E 2x 2P+E
~400V ~230V



- ~230V; 2P+E
- P_{max} = 1200 W coiled
- P_{max} = 1200 W zwinięty
- P_{max} = 3000 W uncoiled
- P_{max} = 3000 W rozwinięty
- ~400V; 3P+N+E
- P_{max} = 3000 W coiled
- P_{max} = 3000 W zwinięty
- P_{max} = 9000 W uncoiled
- P_{max} = 9000 W rozwinięty

POLYBAG

YATO	L (m)	
YT-8120	25	1



GB Spiral bar mixer
D Rundenrührer für klebrige, geschmeidige Materialien
PL Mieszadło spiralne prętowe
RUS Краскомешалка

CZ Spirálové míchadlo drátové
H Spirális, pálcás keverő
RO Malaxor pt. vopsea
F Malaxeur spiral

I Mescolatore spirale
E Agitadore pala/cinta
CN 搅拌器



- application: powder materials, general-purpose adhesives, gypsum surface finishing mixes, epoxy grouts
- zastosowanie: materiały sypkie, gotowe zaprawy klejowe, masy szpachlowe, zaprawy do spoinowania

YATO 	Ø (mm)	L (mm)	shank / uchwyt	max. mixing capacity / max. wydajność mieszania (kg)	
YT-5490	85	410	HEX	4-9	30
YT-5491	100	600	HEX	6-16	16
YT-5492	85	450	SDS+	4-9	30
YT-5493	100	600	SDS+	6-16	16



GB Spiral mixer
D Rondenrührer für dünnflüssige Materialien
PL Mieszadło spiralne
RUS Краскомешалка

CZ Spirálové míchadlo
H Spirális keverő
RO Malaxor pt. vopsea
F Malaxeur spiral

I Mescolatore spirale
E Agitador de cinta helicoidal
CN 搅拌器



- application: emulsion paints, acrylic paints, lacquers, stains, other liquid materials
- zastosowanie: farby emulsyjne, farby akrylowe, lakiery, bejce, inne materiały płynne

YATO 	Ø (mm)	L (mm)	shank / uchwyt	max. mixing capacity / max. wydajność mieszania (kg)	
YT-5494	80	400	HEX	5-10	30
YT-5496	100	600	SDS+	15-30	20



GB Double spiral mixer
D Wendelrührer für klebrige, zähe Materialien
PL Mieszadło spiralne podwójne
RUS Краскомешалка

CZ Spirálové míchadlo dvojitě
H Dupla spirális keverő
RO Malaxor spirala dubla pt. vopsea
F Malaxeur spiral double

I Mescolatore a doppia spirale
E Agitador de cinta helicoidal doble
CN 搅拌器



- application: general-purpose adhesives, masonry mortars, jointless floors, thin-layer mineral plasters, gypsum surface finishing mixes, isolation masses
- zastosowanie: zaprawy klejowe, zaprawy murarskie, jastrych, tynki strukturalne, masy szpachlowe, masy izolacyjne

YATO 	Ø (mm)	L (mm)	shank / uchwyt	max. mixing capacity / max. wydajność mieszania (kg)	
YT-5497	70	400	HEX	5-10	20
YT-5499	100	600	HEX	10-20	16
YT-5500	120	600	HEX	15-25	14
YT-5501	100	600	SDS+	10-20	16
YT-5502	120	600	SDS+	15-25	14
YT-5503	120	600	M14	15-25	14
YT-5504	160	600	M14	20-30	8



GB Triple spiral mixer
D Wendelrührer für schwere, zähe Materialien
PL Mieszadło spiralne potrójne
RUS Краскомешалка

CZ Spirálové míchadlo trojitě
H Tripla spirális keverő
RO Malaxor spirala tripla pt. vopsea
F Malaxeur spiral triple

I Mescolatore a triplo spirale
E Agitador de cinta helicoidal triple
CN 搅拌器



- application: mortars, concrete, plasters, other semi-fluid materials with sand or gravel filling
- zastosowanie: zaprawy, beton, tynki, inne półpłynne, lepkie materiały z wypełnieniem piaskowym lub żwirowym

YATO 	Ø (mm)	L (mm)	shank / uchwyt	max. mixing capacity / max. wydajność mieszania (kg)	
YT-5505	100	600	HEX	10-20	16
YT-5506	120	600	SDS+	15-25	12
YT-5507	120	600	M14	15-25	12
YT-5508	160	600	M14	20-30	8

- | | | |
|------------------------|------------------------|------------------------|
| GB Carpenter's pencil | CZ Tesařská tužka | I Matita per falegnami |
| D Zimmermannsbleistift | H Asztalos ceruza | E Lapiz de carpintero |
| PL Ołówek stolarski | RO Creion de tâmplărie | CN 木工铅笔 |
| RUS Карандаш столярный | F Crayon menuisier | |

COLOR BOX



144 PCS HB



YATO	L (mm)	W (mm)	PCS packing	
YT-6925	245	15	144	8



YATO	L (mm)	W (mm)	PCS packing	
YT-6926	245	12	144	8

- | | | |
|------------------------|-------------------|-----------------------|
| GB Masonry pencil | CZ Tužka zednická | I Matita per muratori |
| D Maurerbleistift | H Kőműves keverő | E Lapiz de albañil |
| PL Ołówek murarski | RO Creion | CN 木工铅笔 |
| RUS Карандаш каменщика | F Crayon maçon | |

COLOR BOX



144 PCS HB

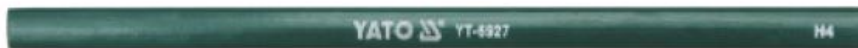

YATO	L (mm)	W (mm)	PCS packing	
YT-6927	245	12	144	8

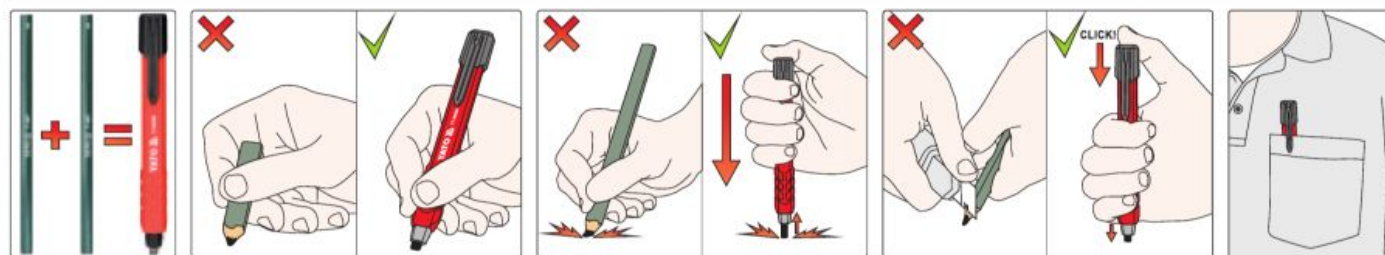

- | | | |
|--|---|--|
| GB Automatic carpenters / masonry pencil | CZ Stolařská / zednická tužka automatická | I Matita per falegnami e carpentieri |
| D Tischler- und Maurer-Druckstift | H Asztalos / kőműves töltőceruza | E Lápiz automático de carpintero / albañil |
| PL Ołówek stolarski / murarski automatyczny | RO Creion de tâmplărie / zidărie mecanic | CN 自动木工铅笔 |
| RUS Автоматический столярный карандаш / карандаш каменщика | F Crayon menuisier / maçon automatique | |

HB



YATO	
YT-69280	50/1000

13

- | | | |
|---|--|---|
| GB Automatic carpenters / masonry pencil with spare leads | RUS Автоматический столярный карандаш / карандаш каменщика + дополнительный графит | F Crayon menuisier / maçon automatique |
| D Tischler- und Maurer-Druckstift + zusätzliche Bleistiftmine | CZ Stolařská / zednická tužka automatická + náhradní tuha | I Matita per falegnami e carpentieri ricaricabile |
| PL Ołówek stolarski / murarski automatyczny + dodatkowe grafity | H Asztalos / kőműves töltőceruza + tartalék grafit | E Lápiz automático de carpintero / albañil + mina adicional |
| | RO Creion de tâmplărie / zidărie mecanic + grafit adițional | CN 自动木工铅笔组套 |

1+5 LEADS WKŁADY HB



BLISTER CARD

DISPLAY COLOR BOX

24 PCS

YATO	
YT-69281	144

- | | |
|--------------------|--------------|
| GB Lead HB | RO Grafit HB |
| D Bleistiftmine HB | F Mine HB |
| PL Grafit HB | I Grafite HB |
| RUS Графит HB | E Mina HB |
| CZ Tuha HB | CN 自动木工铅笔笔芯 |
| H Grafit HB | |

PLASTIC TUBE



5 LEADS WKŁADÓW HB



for / dla: YT-69280, YT-69281

YATO	
YT-69285	20/1000

- | | |
|--------------------|--------------|
| GB Lead H2 | RO Grafit H2 |
| D Bleistiftmine H2 | F Mine H2 |
| PL Grafit H2 | I Grafite H2 |
| RUS Графит H2 | E Mina H2 |
| CZ Tuha H2 | CN 自动木工铅笔笔芯 |
| H Grafit H2 | |

PLASTIC TUBE



5 LEADS WKŁADÓW H2



for / dla: YT-69280, YT-69281

YATO	
YT-69286	20/1000

- | | |
|--------------------|--------------|
| GB Lead HB | RO Grafit HB |
| D Bleistiftmine HB | F Mine HB |
| PL Grafit HB | I Grafite HB |
| RUS Графит HB | E Mina HB |
| CZ Tuha HB | CN 自动木工铅笔笔芯 |
| H Grafit HB | |

PLASTIC TUBE



5 LEADS WKŁADÓW HB WHITE BIAŁY



for / dla: YT-69280, YT-69281

YATO	
YT-69287	20/1000

Memo

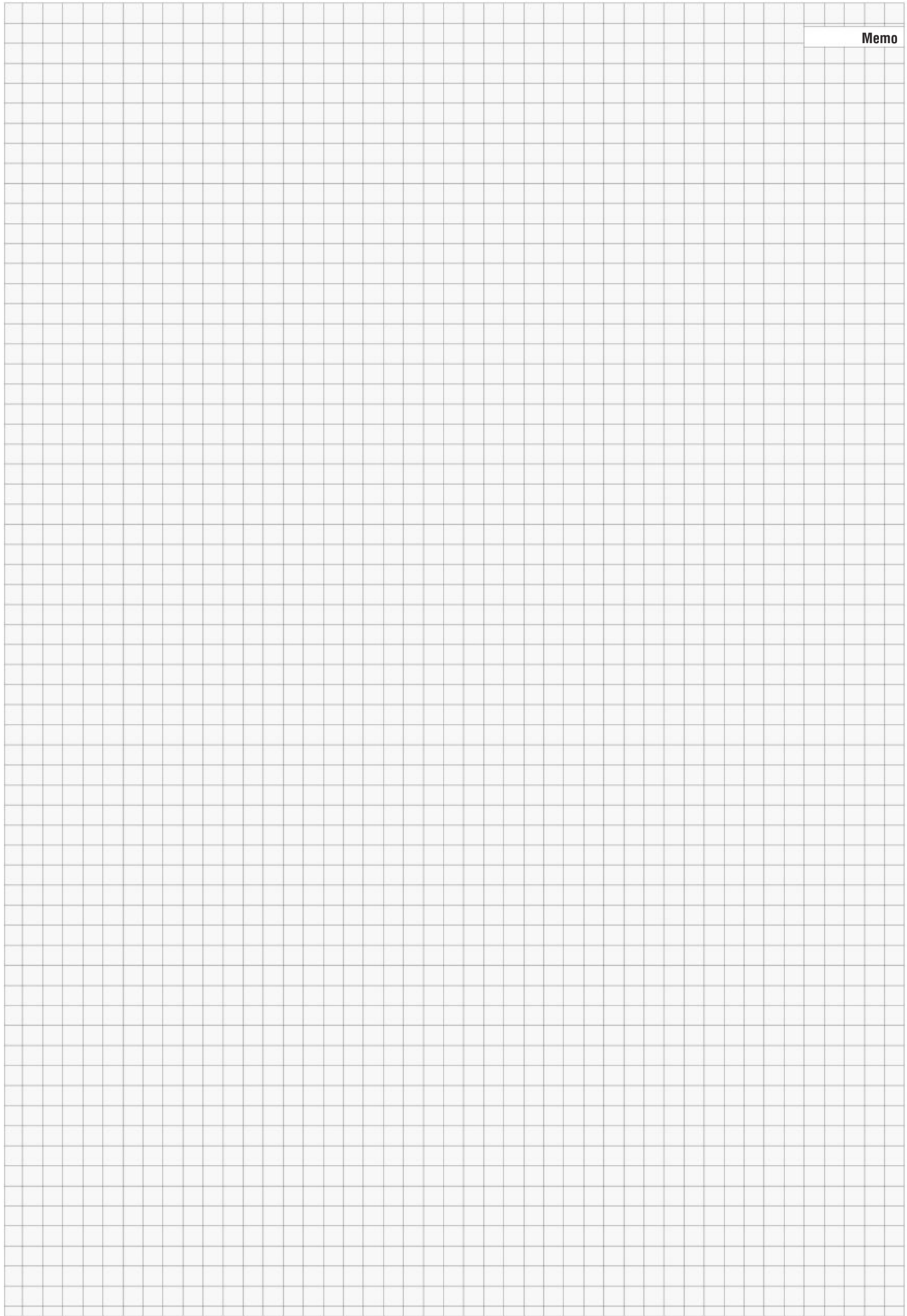

14

Measuring tools Narzędzia miernicze



Electric meters
Mierniki elektryczne

256



Micrometers
Mikrometry

260



Multimeters
Mierniki

256-257



Electronic measuring tools
Elektroniczne urządzenia pomiarowe

261-262



Hygrometers
Higrometry

257



Levels
Poziomnice

262-263



Measuring tapes
Miary zwijane

258



Feelers
Szczelinomierze

263



Rulers
Przymiary

259



Dividers & calipers
Cyrkle i macki

263-264



Steel set squares
Ekiarki metalowe

259



Protractors
Kątomierze

264



Try squares
Kątowniki stolarskie

259



Screw pitch gauges
Sprawdziany grzebieniowe do gwintów

264



Vernier calipers
Suwmiarki

260



GB Digital voltage tester
D Digitaler-Spannungsprüfer
PL Wskaźnik elektryczny
RUS Тестер напряжения цифровой

CZ Zkoušečka napětí digitální
H Digitális voltmérő
RO Tester digital pt. tensiune electrica

F Testeur de tension type tournevis
I Cerca fase digitale

E Indicador eléctrico
CN 数显测电笔



SLIDING CARD

12-250 V

50-500 Hz

TEST

LED DISPLAY WYKWIETLĄCZ

NO BATTERY NEEDED
NIE POTRZEBUJĘ BATERII

YATO

YT-2861

20/500



LED

NO BATTERY NEEDED
NIE POTRZEBUJĘ BATERII

YATO

YT-2862

20/500



LED

3x1.5 V LR41 BATTERY

YATO

YT-28630

6/120

GB Analogue battery tester
D Analoges Batterieprüfgerät
PL Tester akumulatorów analogowy
RUS Аналоговый тестер аккумуляторов
CZ Analogový tester akumulátorů
H Analóg akkuteszter
RO Tester acumulatori analog
F Testeur de charge batterie
I Tester analogico per batteria
E Tester analógico para acumuladores
CN 电池测试器

COLOR BOX



6V

12V

CCA 200-1000 A

GB Digital battery tester
D Digitales Batterieprüfgerät
PL Tester akumulatorów cyfrowy
RUS Цифровой тестер аккумуляторов
CZ Digitální tester akumulátorů
H Digitális akkuteszter
RO Tester acumulatori digital
F Testeur digital de charge batterie
I Tester digitale per batteria
E Tester digital para acumuladores
CN 电池测试器

COLOR BOX



12V

LED DISPLAY

CCA 150-1400 A

GB Battery tester
D Batterieprüfgerät
PL Tester akumulatorów
RUS Тестер аккумуляторов
CZ Tester akumulátorů
H Akkuteszter
RO Tester acumulatori
F Testeur électronique de charge batterie et alternateur
I Tester per batteria
E Tester para acumuladores
CN 电池测试器

DOUBLE BLISTER



12V

BATTERY TEST

TEST AKUMULATORA

ALTERNATOR TEST

TEST ALTERNATORA



YATO
YT-8310

10



YATO
YT-8311

10



YATO
YT-83101

12/72

GB Digital universal multimeter
D Universell digital Messgerät
PL Cyfrowy miernik uniwersalny

RUS Универсальный цифровой измеритель
CZ Digitální multimetr univerzální
H Digitális multiméter

RO Multimetru digital universal
F Multimètre numérique
I Universale tester digitale

E Manómetro digital universal
CN 数字万用表

U 0-500 mV
U 0-500 ~V
I 0-5 mA
R 0-2 MΩ
h_{FE} PNP NPN
5V P-P

U 0-600 mV
U 0-600 ~V
I 0-10 mA
R 0-2 MΩ
1.5V/9V BATTERY TEST
h_{FE} PNP NPN
DATA HOLD
LED BACKLIGHT
LCD 1999
1.5V 2x AAA

TRUE RMS
U 0-600 mV
U 0-600 ~V
I 0-20 mA
I 0-10 ~A
R 0-20 MΩ
C 0-20 mF
T -40/+1000°C
f 0-60 MHz
h_{FE} PNP NPN
DATA HOLD
AUTO POWER OFF
LED BACKLIGHT
LCD 1999
9V BF22



YATO
YT-73080

50



YATO
YT-73081

50



YATO
YT-73083

20

GB Digital universal multimeter
D Universell digital Messgerät
PL Cyfrowy miernik uniwersalny

RUS Универсальный цифровой измеритель
CZ Digitální multimetr univerzální
H Digitális multiméter

RO Multimetro digital universal
F Multimètre numérique
I Universale tester digitale

E Manómetro digital universal
CN 数字万用表

U 0-300 ~V	U 0-300 ~V	I 0-10 ~A	I 0-10 ~A	R 0-20 MΩ	C 0-1000 μF
T -20°+ +1000°C	h _{FE} PNP NPN	AUTO RANGE AUTO ZAKRES	AUTO POWER OFF WYŁĄCZANIE AUTOMATYCZNE	DATA HOLD	
LED BACKLIGHT POŚWIETLENIE	MAX VALUE DISPLAY WYKAZUJĄCE Maks. WARTOŚĆ				



YATO	
YT-73084	44

5 in 1 5 w 1	U 0-300 ~V	U 0-300 ~V	I 0-10 ~A	I 0-10 ~A	R 0-40 MΩ
C 0-100 μF	f 200 kHz	5%+95%	T -20°+ +1000°C	%RH 30%+ 90%	
3.5-100dB	40000 lx	AUTO RANGE AUTO ZAKRES	AUTO POWER OFF WYŁĄCZANIE AUTOMATYCZNE	DATA HOLD	LED BACKLIGHT POŚWIETLENIE



YATO	
YT-73087	24

TRUE RMS	U 0-600 ~V	U 0-600 ~V	I 0-10 ~A	I 0-10 ~A	R 0-60 MΩ
C 0-60 mF	0.1%+95%	T -40°+ +1370°C	f 0-60 MHz		
h _{FE} PNP NPN	DATA HOLD	AUTO RANGE AUTO ZAKRES	AUTO POWER OFF WYŁĄCZANIE AUTOMATYCZNE	LED BACKLIGHT POŚWIETLENIE	MAGNETIC SWITCH HOLES ZACZEP MAGNETYCZNY



for / dla: YT-73090

YATO	
YT-73085	20

MAX & MIN
VALUE DISPLAY
WYKAZUJĄCE
Maks. WARTOŚĆ

LCD
5999

9V
6F22

L1 L2 L3	U 0-600 ~V	U 0-600 ~V	I 0-10 ~A	I 0-10 ~A	R 0-40 MΩ
C 0-100 μF	f 100 kHz	5%+95%	T -20°+ +1000°C		
DATA HOLD	AUTO POWER OFF WYŁĄCZANIE AUTOMATYCZNE	LED BACKLIGHT POŚWIETLENIE	REL RELATIVE VALUE WARTOŚĆ RELACYJNA		



NYLON CASE
& COLOR BOX

YATO	
YT-73086	24

U 0-600 ~V	U 0-600 ~V	I 0-600 ~A	R 0-200 MΩ	T -20°+ +1000°C	
AUTO RANGE AUTO ZAKRES	AUTO POWER OFF WYŁĄCZANIE AUTOMATYCZNE	DATA HOLD	LED BACKLIGHT POŚWIETLENIE	MAX VALUE DISPLAY WYKAZUJĄCE Maks. WARTOŚĆ	



YATO	
YT-73091	20

GB Hygrometer
D Hygrometer
PL Higrometr
RUS Гигрометр
CZ Hygrometr

H Higrométer
RO Higrometru
F Hygrometre
I Igrometro

E Higrómetro
CN 湿度测试仪



6-42% WOOD DREWNO	0.2-2% WALL MASONRY ŚCIANA I MUR	7 mm MAX SENS. DEPTH Maks. GŁĘBOKOŚĆ POMIARU
-------------------------	--	---

YATO	
YT-73140	66/132



SLIDING
CARD



6-60% WOOD DREWNO	0.2-2.9% WALL I MASONRY ŚCIANA I MUR	10 mm MAX SENS. DEPTH Maks. GŁĘBOKOŚĆ POMIARU
-------------------------	--	--

YATO	
YT-73141	20/40



AUTO
POWER OFF
WYŁĄCZANIE
AUTOMATYCZNE

LCD
DISPLAY
WYKAZUJĄCE

DOUBLE
BLISTER

GB Measuring tape RUS Pылетka H Mérőszalag F Ruban à mesurer E Flexómetro
 D Rollbandmass CZ Měřicí pásmo FO Rulete din pinza I Misura di nastro CN 卷尺
 PL Miara zwijana



3m
16mm



3m
16mm

5m
25mm



DOUBLE BLISTER

3m
16mm



DOUBLE BLISTER

YATO	L (m)	size / rozmiar (mm)	
YT-7103	3	16	12/120
YT-7105	5	19	12/120

YATO	L (m)	size / rozmiar (mm)	
YT-7110	3	16	12/120
YT-7111	5	25	12/120
YT-7112	8	25	6/60

YATO	L (m)	size / rozmiar (mm)	
YT-7126	3	16	12/120
YT-7127	5	19	12/120
YT-7128	8	25	6/60



3m
16mm



YATO	L (m)	size / rozmiar (mm)	
YT-7129	3	16	12/120
YT-7130	5	19	12/120
YT-7131	8	25	6/60

YATO	L (m)	size / rozmiar (mm)	
YT-71055	3	16	12/120
YT-71056	5	19	12/120
YT-71057	5	25	12/120
YT-71058	8	25	6/60

YATO	L (m)	size / rozmiar (mm)	
YT-71060	3	16	12/120
YT-71061	5	19	12/120
YT-71063	5	25	6/60

GB Steel measuring tape F Ruban à mesurer acier
 D Rollbandmass I Misura di nastro a acciaio
 PL Taśma miernicza stalowa E Cinta de medir de acero
 RUS Мерная лента стальная CN 长钢卷尺
 CZ Měřicí pásmo ocelové
 H Acél mérőszalag
 RO Ruleta sticla

20m 13mm 30m 15mm 50m 13mm



DOUBLE BLISTER

YATO	L (m)	size / rozmiar (mm)	
YT-71580	20	13	10/40
YT-71581	30	13	10/40
YT-71582	50	13	5/20

GB Fibreglass measuring tape F Ruban à mesurer fibre-verre
 D Rollbandmass I Misura di nastro in fibra di vetro
 PL Taśma miernicza z włókna szklanego E Cinta de medir - fibra cristal
 RUS Мерная лента фибергласс CN 长纤维卷尺
 CZ Měřicí pásmo - skleněné vlákno
 H Mérőszalag - üvegszál
 RO Ruleta fibra sticla

20m 13mm 30m 15mm 50m 13mm



DOUBLE BLISTER

YATO	L (m)	size / rozmiar (mm)	
YT-71570	20	15	40
YT-71571	30	15	40
YT-71572	50	15	20

GB Fibreglass measuring tape I Misura di nastro in fibra di vetro
 D Rollbandmass E Cinta de medir - fibra cristal
 PL Taśma miernicza z włókna szklanego CN 长纤维卷尺
 RUS Мерная лента фибергласс
 CZ Měřicí pásmo - skleněné vlákno
 H Mérőszalag - üvegszál
 RO Ruleta fibra sticla
 F Ruban à mesurer fibre-verre

30m 15mm 50m 13mm



COLOR BOX

YATO	L (m)	size / rozmiar (mm)	
YT-71540	30	15	10
YT-71541	50	15	10

GB Diameter and circumference measuring tape D Umfang Bandmass
 PL Taśma stalowa do pomiaru średnicy i obwodu
 RUS Циркометр для измерения длины окружности и диаметра
 CZ Cirkometry-měřicí pásky pro obvod a průměr
 H Cirkometer szalagos mérés
 RO Banda pt. masurat circumferinte
 F Ruban à mesurer circomètre
 I Metro a nastro in acciaio per misurare diametri e circonferenze
 E Cirkometer cinta métrica
 CN 圓周尺

+/- 0.01 mm SCALE SKALA 1/16 INCH SS STAINLESS STEEL, SILK NERDZIEWA



COLOR BOX

YATO	diameter / średnica (mm)	circumference / obwód (mm)	
YT-71700	20-300	60-950	50
YT-71701	300-700	940-2200	50
YT-71702	700-1100	2190-3460	50

- GB Aluminium ruler
D Alu zeichen-massstab
PL Przymiar aluminiowy
RUS Линейка алюминиевая
CZ Měřicí lat' hliníková
H Asztalos vonalzó, alumínium

- RO Riglă tâmplar din aluminiu
F Règle aluminium
I Righello di alluminio
E Regla de aluminiu
CN 铝合金直尺

AI



YATO	L (mm)	
YT-7070	300	25/100
YT-7071	600	10/50

- GB Steel set square
D Anschlagwinkeldreieck
PL Ekiarka metalowa
RUS Угольник для плотника и столяра
CZ Úhelník
H Fém derékszög
RO Echer tamplarie
F Équerre de menuisier
I Squadra metallica
E Escuadra metallica
CN 铝合金三角尺

INOX
STAINLESS STEEL
STAL, NEKSIJERNA

AI



HANGING CARD

YATO	L (mm)	
YT-70780	170	6/72
YT-70781	270	6/36

- GB Aluminium alloy triangle
D Anschlagwinkeldreieck
PL Kałownik ciesielski do krokwi
RUS Угольник для плотника и столяра
CZ Úhelník na meranie
H Fém derékszög
RO Echer aluminiu pt. dulgherie
F Équerre triangle règle
I Squadra da carpentiere
E Escuadra metalica
CN 铝合金三角尺

AI

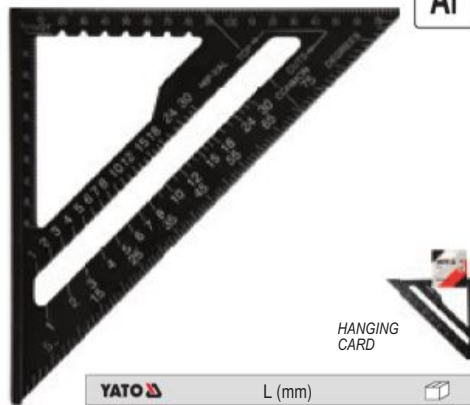

HANGING CARD

YATO	L (mm)	
YT-70786	180	8/64
YT-70787	300	6/24

- GB Folding builder's square
D Bauwinkel Klappbar
PL Kałownik budowlany składany
RUS Угольник складной строительный
CZ Skládací stávařský úhelník
H Összecsukható derékszög
RO Echer pliabil din aluminiu
F Équerre pliante
I Squadra da muratore pieghevole
E Escuadra plegable construcion
CN 折叠铝合金角尺

mm
inch

AI

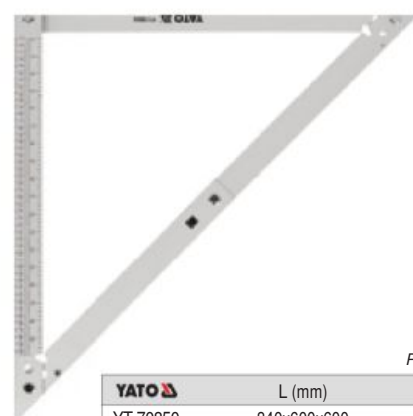

POUCH

YATO	L (mm)	
YT-70850	840x600x600	24
YT-70851	1720x1220x1220	10

- GB Aluminium try square
D Anschlagwinkel
PL Kałownik do płyt gipsowo-kartonowych
RUS Угольник столярный
CZ Truhlářský úhelník černý
H Asztalos derékszög, fekete

- RO Echer de tâmplărie negru
F Équerre
I Squadra per pannelli in gesso
E Escuadra de aluminio
CN T型角尺

1200 mm +/- 0.03 mm

AI



YATO	L (mm)	
YT-70855	1200	10

- GB Aluminium try square
D Anschlagwinkel
PL Kałownik aluminiowy
RUS Угольник столярный
CZ Truhlářský úhelník
H Asztalos derékszög

- RO Echer de tâmplărie
F Equerre en aluminium
I Angolo di alluminio
E Escuadra de aluminio
CN 铝合金角尺

AI

45° 90°

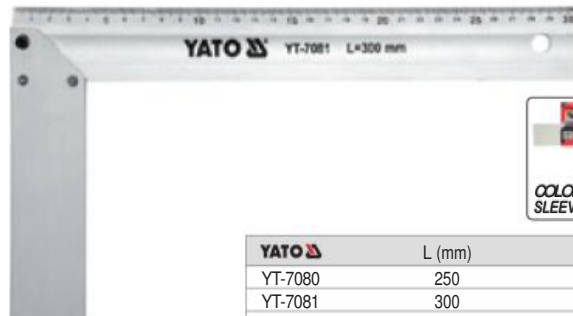

YATO	L (mm)	
YT-7080	250	6/36
YT-7081	300	6/36
YT-7082	350	6/36

- GB Try square
D Anschlagwinkel
PL Kałownik stalowy
RUS Угольник столярный
CZ Truhlářský úhelník
H Asztalos derékszög
RO Echer de tâmplărie
F Equerre
I Angolo di acciaio
E Escuadra
CN 不锈钢角尺

SS
STAINLESS STEEL
STAL, NEKSIJERNA



YATO	size / rozmiar (mm)	
YT-7083	150 x 300	25/100
YT-7084	250 x 500	10/50

GB Vernier caliper
D Messschieber
PL Suwmiarka
RUS Штангенциркуль
CZ Posuvné měřtko
H Tolómérő
RO Şubler
F Pied à coulisse
I Calibro
E Calibre
CN 游标卡尺



+/- 0.02 mm
SCALE SKALA mm inch
SS STAINLESS STEEL / STAŁA NIERDZAWNA

PLASTIC CASE & COLOR BOX

YATO	range / zakres (mm)	
YT-7200	0-150	50

GB Digital caliper
D Digital Messschieber
PL Suwmiarka elektroniczna
RUS Штангенциркуль электронный
CZ Posuvné měřtko elektronické
H Digitális tolómérő
RO Şubler electronic
F Pied à coulisse électronique
I Calibro
E Calibre electrónico
CN 数显卡尺



+/- 0.03 mm
SCALE SKALA mm inch
SS STAINLESS STEEL / STAŁA NIERDZAWNA
BATTERY SR44 1.55V

PLASTIC CASE & COLOR BOX

YATO	range / zakres (mm)	
YT-7201	0-150	10/50

GB Vernier caliper
D Messschieber
PL Suwmiarka
RUS Штангенциркуль
CZ Posuvné měřtko
H Tolómérő
RO Şubler
F Pied à coulisse
I Calibro
E Calibre
CN 游标卡尺



+/- 0.02 mm
SCALE SKALA mm inch
SS STAINLESS STEEL / STAŁA NIERDZAWNA

PLASTIC CASE & COLOR BOX

YATO	range / zakres (mm)	
YT-72003	0-200	30
YT-72004	0-300	20

GB Disc brake vernier caliper
D Scheibenbremse noniusschieber
PL Suwmiarka do tarcz hamulcowych
RUS Штангенциркуль для тормозных листов
CZ Digitální posuvné měřtko na brzdové kotouče
H Tártsafék tolómérő

RO Subler pt. masurat discuri de frana cu display digital
F Disque de frein etrier vernier
I Calibro a corsoio per dischi del freno
E Freno de disco pie de rey
CN 制动片卡尺

160 mm
0-60 mm RANGE ZAKRES
+/- 0.01 mm
SS STAINLESS STEEL / STAŁA NIERDZAWNA

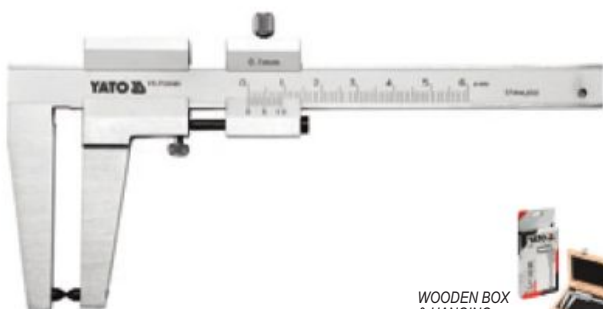

WOODEN BOX & HANGING COLOR BOX

YATO	range / zakres (mm)	
YT-72090	0-60	50

GB Disc brake digital caliper
D Digitalen Scheibenbremse
PL Suwmiarka elektroniczna do tarcz hamulcowych
RUS Штангенциркуль электронный для тормозных листов
CZ Elektronicke posuvné měřtko na brzdové kotouče
H Electronikus tártsafék tolómérő

RO Subler pt. masurat discuri de frana cu display digital
F Disque de frein etrier électronique
I Calibro a corsoio elettronico per dischi del freno
E Pie de rey digital para discos de freno
CN 制动片卡尺

180 mm
0-70 mm RANGE ZAKRES
+/- 0.03 mm
55mm JAWS SZCZĘKI
mm inch
LCD DISPLAY WYŚWIETLACZ
CR2032 3V BATTERY BATERIA
SS STAINLESS STEEL / STAŁA NIERDZAWNA



WOODEN BOX & HANGING COLOR BOX

YATO	range / zakres (mm)	
YT-72093	0-70	50

GB Micrometer
D Mikrometer
PL Mikrometr
RUS Микрометр

CZ Mikrometr
H Mikrométer
RO Micrometru
F Micromètre

I Micrometro
E Micrómetro
CN 外径千分尺

+/- 0.01 mm



PLASTIC CASE & COLOR BOX

YATO	range / zakres (mm)	
YT-72300	0-25	100
YT-72301	25-50	60
YT-72302	50-75	50
YT-72303	75-100	20

GB Micrometer with a digital display
D Mikrometer mit Digitalanzeige
PL Mikrometr z wyświetlaczem cyfrowym
RUS Микрометр с цифровым индикатором
CZ Mikrometr s digitálním displejem

H Mikrométer digitális kijelzővel
RO Micrometru cu afişaj digital
F Micromètre
I Micrometro con digitale elettronico
E Micrómetro con pantalla digital
CN 杆珩偶噤 照喜

+/- 0.01 mm
SCALE SKALA mm inch
LCD DISPLAY WYŚWIETLACZ



PLASTIC CASE & COLOR BOX

YATO	range / zakres (mm)	
YT-72305	0-25	50

- GB Stud finder
- D Entfernungsmesser
- PL Wykrywacz profili i przewodów
- RUS Цифровой детектор
- CZ Digitální detektor
- H Digitális kereső műszer
- RO Detector digital
- F Détecteur de métaux et de câbles électriques
- I Detector digitale
- E Escáner de pared
- CN 墙体探测仪



HANGING
COLOR
BOX

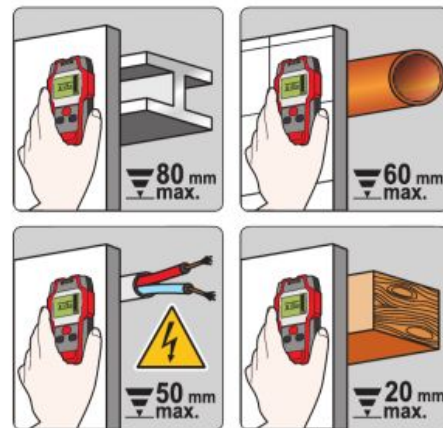

YATO

YT-73131

40

- GB Laser distance meter
- D Laserentfernungsmesser
- PL Dalmierz laserowy
- RUS Лазерный дальномер
- CZ Laserový měřič vzdálenosti
- H Lézeres távolságmérő
- RO Telemetru cu laser
- F Télémètre laser
- I Telemetro laser
- E Medidores láser de distancias
- CN 激光测距仪

COLOR
BOX

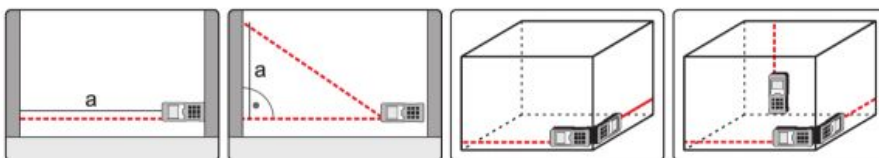

- 40 m
- 0.2-40 m
+/- 2 mm
- 20 MEMORY
PAMIĘĆ
- 10 MODES
TRYBÓW
- CONSTANT ANGLE PITCH MEASUREMENT
CIĄGŁY POMIAR KĄTÓW NACZYLIENIA
- IP65
- USB
TYPE C



YATO

YT-73126

20



Tripod not included
Statyw nie jest częścią zestawu

- 60 m
- 0.2-60 m
+/- 2 mm
- 20 MEMORY
PAMIĘĆ
- 10 MODES
TRYBÓW
- CONSTANT ANGLE PITCH MEASUREMENT
CIĄGŁY POMIAR KĄTÓW NACZYLIENIA
- IP65
- USB
TYPE C



YATO

YT-73127

20



Tripod not included
Statyw nie jest częścią zestawu

- GB Crossline laser level
- D Selbstnivellierung Laserkreuz
- PL Laser krzyżowy samopoziomujący ze spodarką
- RUS Линейный лазерный нивелир
- CZ Křížový laser
- H Keresztugaras lézeres
- RO Nivelă laser
- F Niveau cross laser
- I Laser a croce
- E Nivel láser cruzado
- CN 调平两线水平仪

- 635 Nm
LASER CLASS II
DŁUGOŚĆ FALI
- ±1.5 mm / 5 m
LASER ACCURACY
DOKŁADNOŚĆ LASERA
- 4.5V
3x
AA
- 15°C-40°C
WORK TEMPERATURE
TEMPERATURA PRACY
- IP54
- 20 m
WORKING RANGE
ZAKRES PRACY
- ±3°
SELF-LEVELING
HORIZONTAL
- 30h
WORK TIME
CZAS PRACY



YATO

YT-30425

12



NYLON CASE
& COLOR BOX

- GB 5-point laser level
- D 5- Punkt laser
- PL Laser pięciopunktowy
- RUS Лазерный нивелир
- CZ 5 bodový laser
- H Keresztugaras és 5 pontos lézer
- RO Nivelă laser în 5 puncte
- F Niveau laser 5 points
- I Laser a cinque punte
- E Nivel láser de 5 puntos - rojo
- CN 五点水平仪

- 635 Nm
LASER CLASS II
DŁUGOŚĆ FALI
- ±1.5 mm / 5 m
LASER ACCURACY
DOKŁADNOŚĆ LASERA
- 4.5V
3x
AA
- 15°C-40°C
WORK TEMPERATURE
TEMPERATURA PRACY
- IP54
- 20 m
WORKING RANGE
ZAKRES PRACY
- ±3°
SELF-LEVELING
SELF-LEVELING HORIZONTAL
- 30h
WORK TIME
CZAS PRACY



YATO

YT-30427

12



NYLON CASE
& COLOR BOX

GB Rotation self-leveling laser level / RUS Линейный нивелир / Laser rotante autolivellante
 D Selbstnivellierung Rotationslaser / CZ Rotační laser / E Láser rotativo motorizado rojo
 PL Laser rotacyjny samopoziomujący / H Forgó lézer / RO Laserul rotativ universal / F Niveau laser rotatif / CN 红光电子扫平仪



635 Nm LASER CLASS LASER CLASS II
 ± 1 mm / 1.5 m LASER ACCURACY (MAX. RANGE) CLASS II
 -10°C - 45°C WORK TEMPERATURE RANGE
 ± 5° MAXIMUM TILT (MAX. RANGE)
 10° 180° 45° 180°
 IP54
 4.8-6 V 4c 3500mAh (Ni-MH)

BMC & COLOR BOX

YATO	YT-30430	4
-------------	----------	---

GB Aluminium level / CZ Vodováha / I Livella
 D Wasserwaage / H Vizmérték / E Nivel
 PL Poziomnica aluminiowa / RO Cumpănă / CN 铝合金水平尺
 RUS Уровень / F Niveau à bulle



ACCURACY DOKŁADNOŚĆ 0.057" = 1.0 mm/m
 3 PRECISION VIALS LIBELLE
 1.5 mm ALUMINIUM HIGH QUALITY PROFILE (PROFIL WYSOKI JAKOŚCI)

SHOCK PROOF ODPORNA NA WSTRZĄSY

YATO	L (mm)	
YT-3001	400	20/60
YT-3002	600	20/60
YT-3003	800	20/60
YT-3004	1000	20/60
YT-3005	1200	20/60



ACCURACY DOKŁADNOŚĆ 0.057" = 1.0 mm/m
 3 PRECISION VIALS LIBELLE
 1.5 mm ALUMINIUM HIGH QUALITY PROFILE (PROFIL WYSOKI JAKOŚCI)

YATO	L (mm)	
YT-3022	600	20/60
YT-3023	800	20/60
YT-3024	1000	30
YT-3025	1200	30
YT-3026	1500	30



ACCURACY DOKŁADNOŚĆ 0.027" = 0.5 mm/m
 ALUMINIUM HIGH QUALITY PROFILE (PROFIL WYSOKI JAKOŚCI)
 3 PRECISION VIALS LIBELLE

YATO	L (mm)	
YT-30071	600	10/40
YT-30072	800	10/30
YT-30073	1000	10/20
YT-30074	1200	10/20



ACCURACY DOKŁADNOŚĆ 0.027" = 0.5 mm/m
 ALUMINIUM HIGH QUALITY PROFILE (PROFIL WYSOKI JAKOŚCI)
 2 PRECISION VIALS LIBELLE

YATO	L (mm)	
YT-30061	600	10/40
YT-30062	800	10/30
YT-30063	1000	10/20
YT-30064	1200	10/20

GB Trapezoidal spirit level / CZ Vodováha trapezová / I Livella trapezoidale
 D Trapezförmige Wasserwaage / H Vizmérték trapéz / E Trapezoides nivel
 PL Poziomnica trapezowa / RO Nivelă trapezoidală / CN 水平尺
 RUS Трапецидальный уровень духа / F Trapezes niveau



SHOCK PROOF ODPORNA NA WSTRZĄSY
 ALUMINIUM HIGH QUALITY PROFILE (PROFIL WYSOKI JAKOŚCI)
 ACCURACY DOKŁADNOŚĆ 0.027" = 0.5 mm/m



2 PRECISION VIALS LIBELLE

YATO	L (mm)	
YT-30370	250	60



3 PRECISION VIALS LIBELLE

YATO	L (mm)	
YT-30375	600	24

GB Electronic laser level
D Elektronische Laser Wasserwaage
PL Poziomnica elektroniczna z laserem
RUS Уровни электронные лазерные

CZ Úrovňe elektronické laser
H Elektronikus vízmérték lezerek
RO Nivelurile laser electronice
F Niveaux laser électronique

I Livella elettronica con laser
E Niveles láser electrónica
CN 数显激光水平尺

2
PRECISION
VIALS
LIBELLE

ALUMINUM
HIGH QUALITY
PROFILE
ALUMINIUM
PROFIL WYSOKA
JAKOŚĆ

ACCURACY
DOKŁADNOŚĆ
= 0.027°
= 0.5 mm/m

LASER
ACCURACY
DOKŁADNOŚĆ
LASERA
± 0.3 mm /
10 m

WIDE
TEMPERATURE
TEMPERATURA
PRACY
0°C-60°C

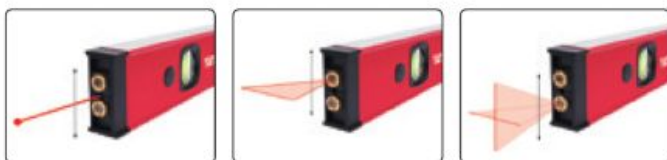

DOUBLE
BLISTER

YATO	L (mm)	
YT-30400	610	20

GB Feeler
D Fühlerlehre
PL Szczelinomierz
RUS Щупы
CZ Spároměr
H Hézagmérő

RO Lere
F Palpeur
I Spessimetro
E Calibre de furas
CN 塞尺

DOUBLE
BLISTER



100
mm

10
mm

17
GAUGES
LISTKÓW

TAPER
ZBIĘŻNY

YATO	L (mm)	width / szerokość	size / rozmiar	
YT-7220	100	10	0.02; 0.03; 0.04; 0.05; 0.06; 0.07; 0.08; 0.09; 0.10; 0.15; 0.20; 0.25; 0.30; 0.40; 0.50; 0.75; 1.00	10/200



200
mm

12.8
mm

17
GAUGES
LISTKÓW

PARALLEL
RÓWNOLEGŁY

YATO	L (mm)	width / szerokość	size / rozmiar	
YT-7221	200	12.8	0.02; 0.03; 0.04; 0.05; 0.06; 0.07; 0.08; 0.09; 0.10; 0.15; 0.20; 0.25; 0.30; 0.40; 0.50; 0.75; 1.00	10/100



100
mm

10
mm

10
GAUGES
LISTKÓW

TAPER
ZBIĘŻNY

YATO	L (mm)	width / szerokość	size / rozmiar	
YT-7222	100	10	0.05; 0.06; 0.07; 0.08; 0.09; 0.10; 0.20; 0.30; 0.40; 0.50	10/100



200
mm

12.8
mm

14
GAUGES
LISTKÓW

PARALLEL
RÓWNOLEGŁY

YATO	L (mm)	width / szerokość	size / rozmiar	
YT-7223	200	12.8	0.05; 0.06; 0.07; 0.08; 0.09; 0.10; 0.15; 0.20; 0.25; 0.30; 0.35; 0.40; 0.45; 0.50	10/100



GB Divider
D Bogenspitzzirkel
PL Cyrkiel z prowadnicą
RUS Циркуль разметочный с подвижной дугой
H Ipari körző
RO Compas de trasaj
F Compas traçoir
I Compasso con guida
E Compas con fijador
CN 制动片卡尺



150
mm

200
mm

300
mm

SLIDING
CARD

GB Spring divider
D Zirkel mit Stift
PL Cyrkiel ze sprężyną i śrubą
RUS Циркуль разметочный с винтом
CZ Kružidlo s pružinou
H Precíziós körző
RO Compas de trasaj cu reglaj
F Compas à ressort
I Compasso con molla e vite
E Compas de puntas, con muelle
CN 弹簧卡尺



150
mm

200
mm

300
mm

SLIDING
CARD

GB Outside caliper
D Greifzirkel (Außentaster)
PL Macka zewnętrzna
RUS Кронциркуль для наружных измерений
CZ Hmatadlo
H Külső jelölő
RO Calibru masurat exterior
F Compas d'épaisseur
I Comparatore a bracci tastatori per esterni
E Compas planos para exteriores
CN 外卡规



200
mm

300
mm

SLIDING
CARD

YATO	L (mm)	
YT-72100	150	50
YT-72101	200	50
YT-72102	300	100

YATO	L (mm)	
YT-72106	150	50
YT-72107	200	100
YT-72108	300	50

YATO	L (mm)	
YT-72115	200	100
YT-72116	300	100

GB Outside caliper with spring
 D Aussenzirkel
 PL Macka zewnętrzna sprężynowa
 RUS Кронциркуль для наружных измерений с винтом
 CZ Obkročné hmatadlo se stavěcím šroubem
 H Precíziós külső jelölő
 RO Calibru masurat exterior cu reglaj
 F Compas a ressort d'épaisseur
 I Comparatore a bracci tastatori per esterni a molla
 E Compas para exteriores, con muelle
 CN 弹簧外卡规



150 mm

200 mm

250 mm

SLIDING CARD

YATO	L (mm)	
YT-72120	150	50
YT-72121	200	100
YT-72122	250	100

GB Inside caliper with spring
 D Innenzirkel
 PL Macka wewnętrzna sprężynowa
 RUS Кронциркуль-нутромер для внутренних измерений с винтом
 CZ Hmatadlo vnútorné s pružinou
 H Precíziós jelölő körző
 RO Calibru masurat interior cu reglaj
 F Compas à ressort d'intérieur
 I Comparatore a bracci tastatori per interni a molla
 E Compas para interiores, con muelle
 CN 弹簧内卡规

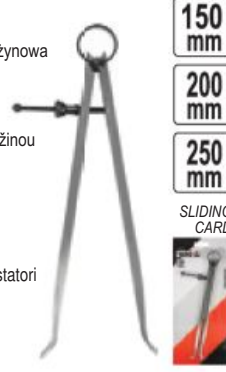

150 mm

200 mm

250 mm

SLIDING CARD

YATO	L (mm)	
YT-72125	150	100
YT-72126	200	100
YT-72127	250	100

GB Inside caliper
 D Lochzirkel
 PL Macka wewnętrzna
 RUS Кронциркуль-нутромер для внутренних измерений
 CZ Hmatadlo
 H Belső jelölő körző
 RO Calibru masurat interior
 F Compas d'intérieur
 I Comparatore a bracci tastatori per interni
 E Compas planos para interiores
 CN 制动片卡尺



150 mm

200 mm

300 mm

SLIDING CARD

YATO	L (mm)	
YT-72130	150	100
YT-72131	250	100
YT-72132	300	100

GB Protractor
 D Winkelmesser
 PL Kątomierz
 RUS Транспортёр
 CZ Protractor
 H Szögmérő
 RO Muşchi extensor
 F Rapporteur
 I Rapportatore
 E Transportador
 CN 量角器



POUCH & HANGING COLOR BOX



+/- 0.01 mm

YATO	size / rozmiar (mm)	
YT-72140	120x150	50
YT-72141	150x200	50

GB Screw pitch gauges
 D Gewinde-Messlehre
 Lehrenblätter
 PL Sprawdzian grzebieniowy do gwintów
 RUS Резьбмер
 CZ Test hřebení
 H Menetsablon
 RO Set lere filet
 F Manometre pour filetage
 I Pettine per filetti
 E Galga para roscas
 CN 讀框莫



SLIDING CARD



METRIC METRYCZNE
 0.25-6.0 mm
 60°
 24 BLADES OSTRZA

YATO	thread types / rodzaje gwintów metric / metryczne (mm)	
YT-29980	0.25; 0.3; 0.35; 0.4; 0.45; 0.5; 0.6; 0.7; 0.75; 0.8; 0.9; 1.0; 1.25; 1.5; 1.75; 2.0; 2.5; 3.0; 3.5; 4.0; 4.5; 5.0; 5.5; 6.0	30/300



WHITWORTH
 4-62
 55°
 28 BLADES OSTRZY

YATO	thread types / rodzaje gwintów Whitworth	
YT-29982	4; 4.5; 5; 6; 7; 8; 9; 10; 11; 12; 13; 14; 15; 16; 18; 20; 22; 24; 25; 26; 28; 30; 32; 36; 40; 48; 60; 62	30/300



METRIC METRYCZNE
 0.25-6.0 mm
 60°
 WHITWORTH
 4-62
 55°
 52 BLADES OSTRZA

YATO	thread types / rodzaje gwintów metric / metryczne (mm)	Whitworth	
YT-29984	0.25; 0.3; 0.35; 0.4; 0.45; 0.5; 0.6; 0.7; 0.75; 0.8; 0.9; 1.0; 1.25; 1.5; 1.75; 2.0; 2.5; 3.0; 3.5; 4.0; 4.5; 5.0; 5.5; 6.0	4; 4.5; 5; 6; 7; 8; 9; 10; 11; 12; 13; 14; 15; 16; 18; 20; 22; 24; 25; 26; 28; 30; 32; 36; 40; 48; 60; 62	20/200

Memo

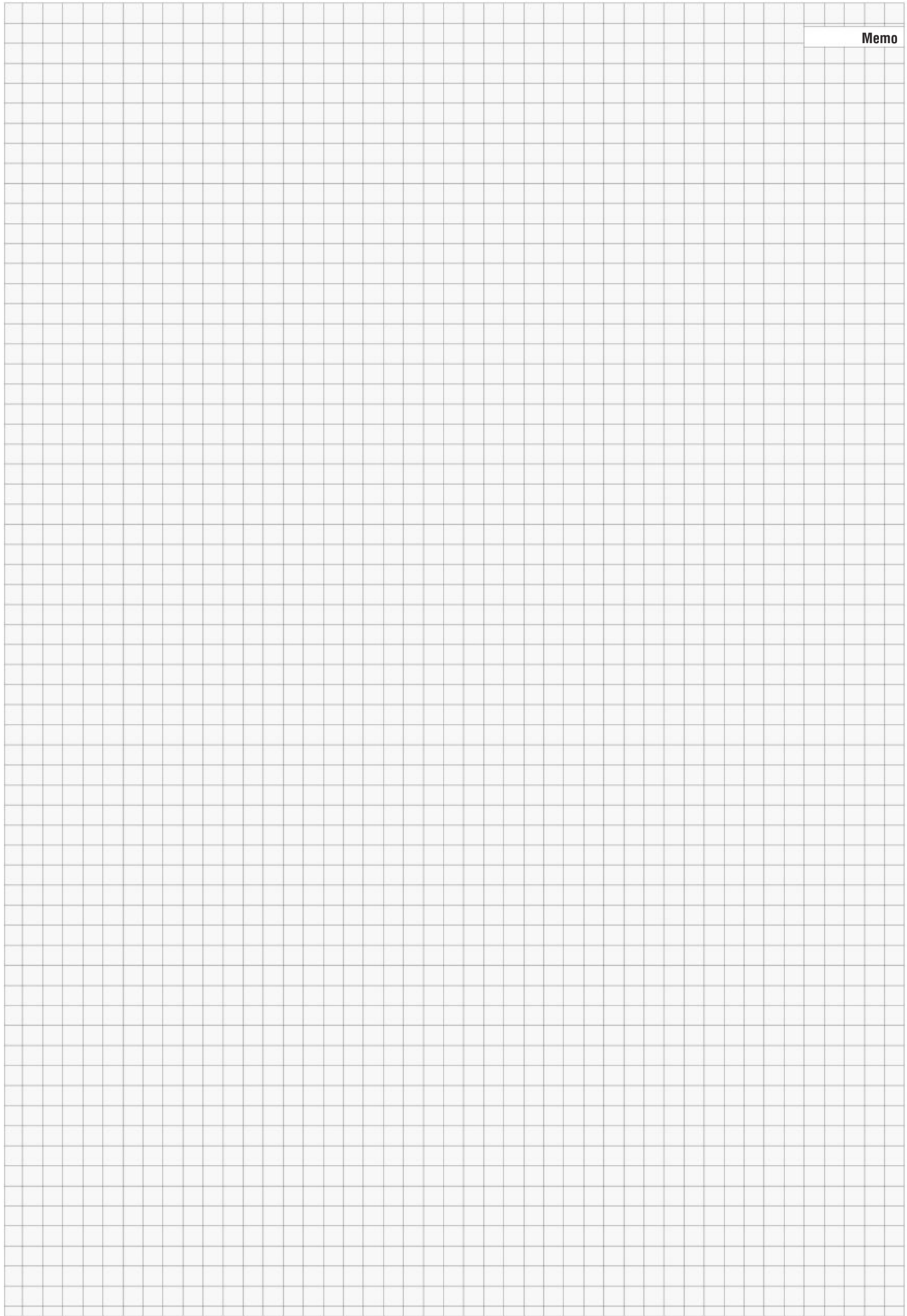

15

Pneumatic tools Narzędzia pneumatyczne



Impact wrenches
Klucze udarowe

268-271



Pneumatic accessories

Akcesoria instalacji pneumatycznej

279-282



Impact wrenches 1/2"

Klucze udarowe 1/2"

268

Impact wrenches 3/4"

Klucze udarowe 3/4"

270

Impact wrenches 1"

Klucze udarowe 1"

270

Air filters, regulators & lubricators

Filtry, reduktory i smarownice

279

Spiral hoses

Wężę spiralne

280

Reinforced hoses

Wężę zbrojone

280

Couplers

Złącza

281

Other air tools

Inne narzędzia pneumatyczne

271-277



Air grease guns

Smarownice pneumatyczne

282



Pneumatic ratchets & sets

Grzechotki pneumatyczne i zestawy

271

Pneumatic grinders & accessories

Szlifierki pneumatyczne i akcesoria

272

Pneumatic cut-off tools & discs

Przecinarki pneumatyczne i tarcze

273

Air body saws

Wyrzynarki pneumatyczne i akcesoria

274

Pneumatic shears

Nożyce pneumatyczne

275

Pneumatic drills

Wiertarki pneumatyczne

275

Pneumatic hammers & accessories

Młotki pneumatyczne i akcesoria

276

Holders for tools

Uchwyty na narzędzia

276

Tire inflating guns & heads

Pistolety do pompowania kół i głowice

277

Air brake bleeders

Urządzenia do wymiany płynu hamulcowego

277

Pneumatic riveters

Nitownice pneumatyczne

283



Pneumatic stitching & nailing machines

Zszywacze i gwoździarki pneumatyczne

283-284



Pneumatic staplers

Zszywacze pneumatyczne

283

Pneumatic nailers

Gwoździarki pneumatyczne

284

Painting equipment & accessories

Narzędzia do malowania i akcesoria

278-279

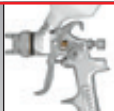

Spray guns

Pistolety lakiernicze

278

Inflating guns

Pistolety do przedmuchiwania

278

Washing guns

Pistolety do ropowania

279

Air sand blasters

Pistolety do piaskowania

279

Work benches

Stojaki lakiernicze

279

GB Impact wrench
 D Druckluft-Schlagschrauber
 PL Klucz pneumatyczny
 RUS Ударный пневматический гайковерт
 CZ Klúč pneumatický
 H Pneumatikus ütvecsavarozó
 RO Pistol pneumatic
 F Clé à choc pneumatique
 I Chiave ad impulsi pneumatica
 E Llave neumática de percusión
 CN 气动扳手

COLOR BOX



1/2" 12.5mm	TWIN HAMMER TYPE	0.63 MPa
119 l/min	550 Nm	7500 min ⁻¹
STANDARD		



TWIN HAMMER™
 mechanism
 ensuring resilience
 to damage and
 overload



$L_{wa} = 92 \pm 3$ dB;
 $L_{pa} = 103 \pm 3$ dB;
 $a_s = 5,47 \pm 1,5$ m/s²

YATO	Nm	
YT-09511	550	8

GB Impact wrench
 D Druckluft-Schlagschrauber
 PL Klucz pneumatyczny
 RUS Ударный пневматический гайковерт
 CZ Klúč pneumatický
 H Pneumatikus ütvecsavarozó
 RO Pistol pneumatic
 F Clé à choc pneumatique
 I Chiave ad impulsi pneumatica
 E Llave neumática de percusión
 CN 气动扳手

COLOR BOX



1/2" 12.5mm	TWIN HAMMER TYPE	0.63 MPa
142 l/min	570 Nm	10000 min ⁻¹
STANDARD		



TWIN HAMMER™
 mechanism
 ensuring resilience
 to damage and
 overload



$L_{wa} = 90,7 \pm 3,0$ dB;
 $L_{pa} = 101,7 \pm 3,0$ dB;
 $a_s = 3,0 \pm 1,5$ m/s²

YATO	Nm	
YT-09505	570	10

GB Impact wrench
 D Druckluft-Schlagschrauber
 PL Klucz pneumatyczny
 RUS Ударный пневматический гайковерт
 CZ Klúč pneumatický
 H Pneumatikus ütvecsavarozó
 RO Pistol pneumatic
 F Clé à choc pneumatique
 I Chiave ad impulsi pneumatica
 E Llave neumática de percusión
 CN 气动扳手

COLOR BOX



1/2" 12.5mm	SINGLE HAMMER TYPE	0.63 MPa
100 l/min	678 Nm	10000 min ⁻¹
STANDARD		



SINGLE HAMMER
 mechanism
 ensuring resilience
 to damage and
 overload

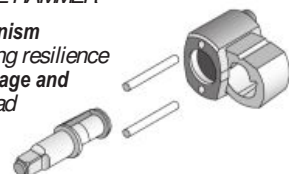

$L_{wa} = 97,4 \pm 3,0$ dB;
 $L_{pa} = 103,0 \pm 3,0$ dB;
 $a_s = 7,3 \pm 1,21$ m/s²

YATO	Nm	
YT-09512	678	10

GB Impact wrench
 D Druckluft-Schlagschrauber
 PL Klucz pneumatyczny
 RUS Ударный пневматический гайковерт
 CZ Klúč pneumatický
 H Pneumatikus ütvecsavarozó
 RO Pistol pneumatic
 F Clé à choc pneumatique
 I Chiave ad impulsi pneumatica
 E Llave neumática de percusión
 CN 气动扳手

COLOR BOX



1/2" 12.5mm	TWIN HAMMER TYPE	0.63 MPa
165 l/min	680 Nm	10000 min ⁻¹
STANDARD		



TWIN HAMMER™
 mechanism
 ensuring resilience
 to damage and
 overload





$L_{wa} = 94,0 \pm 3,0$ dB;
 $L_{pa} = 105,0 \pm 3,0$ dB;
 $a_s = 9,0 \pm 0,4$ m/s²

YATO	Nm	
YT-09513	680	10

GB Impact wrench
D Druckluft-Schlagschrauber
PL Klucz pneumatyczny
RUS Ударный пневматический гайковерт
CZ Klúč pneumatický
H Pneumatikus ütvecsavarozó
RO Pistol pneumatic
F Clé à choc pneumatique
I Chiave ad impulsi pneumatica
E Llave neumática de percusión
CN 气动扳手

COLOR BOX

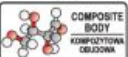



1/2" 12.5mm	TWIN HAMMER TYPE	0.63 MPa
184 l/min	680 Nm	7000max min ⁻¹
 COMPOSITE BODY KOMPETYTYWNA OBUDOWA		 STANDARD



TWIN HAMMER™
mechanism
ensuring resilience
to damage and
overload





$L_{pA} = 95,0 \pm 3,0$ dB;
 $L_{wA} = 106,0 \pm 3,0$ dB;
 $a_s = 9,1 \pm 1,5$ m/s²

YATO 	Nm	
YT-09524	680	5

GB Impact wrench
D Druckluft-Schlagschrauber
PL Klucz pneumatyczny
RUS Ударный пневматический гайковерт
CZ Klúč pneumatický
H Pneumatikus ütvecsavarozó
RO Pistol pneumatic
F Clé à choc pneumatique
I Chiave ad impulsi pneumatica
E Llave neumática de percusión
CN 气动扳手

COLOR BOX





1/2" 12.5mm	TWIN HAMMER TYPE	0.6-0.8 MPa
119 l/min	850 Nm	7000 min ⁻¹
 COMPOSITE BODY KOMPETYTYWNA OBUDOWA		 STANDARD



TWIN HAMMER™
mechanism
ensuring resilience
to damage and
overload





$L_{pA} = 92 \pm 3$ dB;
 $L_{wA} = 103 \pm 3$ dB;
 $a_s = 5,47 \pm 1,5$ m/s²

YATO 	Nm	
YT-09525	850	6

GB Impact wrench
D Druckluft-Schlagschrauber
PL Klucz pneumatyczny
RUS Ударный пневматический гайковерт
CZ Klúč pneumatický
H Pneumatikus ütvecsavarozó
RO Pistol pneumatic
F Clé à choc pneumatique
I Chiave ad impulsi pneumatica
E Llave neumática de percusión
CN 气动扳手

COLOR BOX

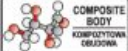

1/2" 12.5mm	TWIN HAMMER TYPE	0.63 MPa
153 l/min	1356 Nm	10000 min ⁻¹
 COMPOSITE BODY KOMPETYTYWNA OBUDOWA		 STANDARD



TWIN HAMMER™
mechanism
ensuring resilience
to damage and
overload





$L_{pA} = 93,7 \pm 3,1$ dB;
 $L_{wA} = 104,7 \pm 3,1$ dB;
 $a_s = 4,4 \pm 0,4$ m/s²

YATO 	Nm	
YT-0953	1356	10

GB Impact wrench
D Druckluft-Schlagschrauber
PL Klucz pneumatyczny
RUS Ударный пневматический гайковерт
CZ Klúč pneumatický
H Pneumatikus ütvecsavarozó
RO Pistol pneumatic
F Clé à choc pneumatique
I Chiave ad impulsi pneumatica
E Llave neumática de percusión
CN 气动扳手

COLOR BOX

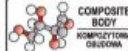



1/2" 12.5mm	TWIN HAMMER TYPE	0.63 MPa
153 l/min	1150 Nm	10000 min ⁻¹
 COMPOSITE BODY KOMPETYTYWNA OBUDOWA		 STANDARD

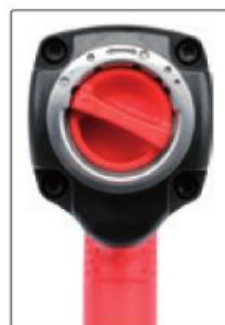

TWIN HAMMER™
mechanism
ensuring resilience
to damage and
overload



$L_{pA} = 93,7 \pm 3,1$ dB;
 $L_{wA} = 104,7 \pm 3,1$ dB;
 $a_s = 4,4 \pm 0,4$ m/s²

YATO 	Nm	
YT-09540	1150	10

GB Impact wrench
 D Druckluft-Schlagschrauber
 PL Klucz pneumatyczny
 RUS Ударный пневматический гайковерт
 CZ Klíč pneumatický
 H Pneumatikus ütvecsavarozó
 RO Pistol pneumatic
 F Clé à choc pneumatique
 I Chiave ad impulsi pneumatica
 E Llave neumática de percusión
 CN 气动扳手

COLOR BOX



3/4" 19 mm	TWIN HAMMER TYPE	0.63 MPa
660 l/min	1300 Nm	5000 min ⁻¹
		3/8" 10 mm



TWIN HAMMER™
 mechanism ensuring resilience to damage and overload



$L_{wA} = 92 \pm 3$ dB;
 $L_{wB} = 103 \pm 3$ dB;
 $a_p = 5,47 \pm 1,5$ m/s²

YATO	Nm	
YT-09564	1300	4

GB Impact wrench
 D Druckluft-Schlagschrauber
 PL Klucz pneumatyczny
 RUS Ударный пневматический гайковерт
 CZ Klíč pneumatický
 H Pneumatikus ütvecsavarozó
 RO Pistol pneumatic
 F Clé à choc pneumatique
 I Chiave ad impulsi pneumatica
 E Llave neumática de percusión
 CN 气动扳手

COLOR BOX



3/4" 19 mm	TWIN HAMMER TYPE	0.63 MPa
198 l/min	1630 Nm	5500 min ⁻¹
		3/8" 10 mm



TWIN HAMMER™
 mechanism ensuring resilience to damage and overload



$L_{wA} = 100,6 \pm 3,0$ dB;
 $L_{wB} = 111,6 \pm 3,0$ dB;
 $a_p = 10,21 \pm 1,5$ m/s²

YATO	Nm	
YT-09571	1630	6

GB Pneumatic wrench
 D Druckluft-Schlüssel
 PL Klucz pneumatyczny
 RUS Пневматический ключ
 CZ Pneumatický utahovák
 H Pneumatikus kulcs
 RO Cheie pneumatica

F Clé à choc pneumatique
 I Chiave ad impulsi pneumatica
 E Llave neumática
 CN 气动扳手

PINLESS HAMMER™
 closed hammer cage mechanism prevents breakage from hammer pin damage



- application: automotive service stations, trucks
- strong, uniform impact
- przeznaczenie: serwis, samochody ciężarowe
- silny, jednolity uder



$L_{wA} = 94,1 \pm 2,8$ dB;
 $L_{wB} = 104,8 \pm 2,8$ dB;
 $a_p = 14,53 \pm 1,93$ m/s²

YATO	Nm	
YT-0959	2600	2

1" 25 mm	PINLESS HAMMER TYPE
0.63 MPa	560 l/min
2600 Nm	4000 min ⁻¹
1/2" 12.5 mm	

BMC & COLOR SLEEVE



GB Pneumatic wrench
 D Druckluft-Schlüssel
 PL Klucz pneumatyczny
 RUS Пневматический ключ
 CZ Pneumatický utahovák
 H Pneumatikus kulcs

RO Cheie pneumatica
 F Clé à choc pneumatique
 I Chiave ad impulsi pneumatica
 E Llave neumática
 CN 气动扳手

PINLESS HAMMER™
 closed hammer cage mechanism prevents breakage from hammer pin damage



- application: automotive service stations, trucks
- strong, uniform impact
- przeznaczenie: serwis, samochody ciężarowe
- silny, jednolity uder



$L_{wA} = 97,2 \pm 2,0$ dB;
 $L_{wB} = 107,7 \pm 2,8$ dB;
 $a_p = 23,28 \pm 4,76$ m/s²

YATO	Nm	
YT-0960	2600	2

1" 25 mm	PINLESS HAMMER TYPE
0.63 MPa	560 l/min
2600 Nm	4000 min ⁻¹
1/2" 12.5 mm	

BMC & COLOR SLEEVE



GB Pneumatic wrench
D Druckluft-Schlüssel
PL Klucz pneumatyczny
RUS Пневматический ключ
CZ Pneumatiký utahovák
H Pneumatikus kulcs
RO Cheie pneumatica
F Clé à choc pneumatique
I Chiave ad impulsi pneumatica
E Llave neumática
CN 气动扳手



COLOR BOX



1" 25mm	TWIN HAMMER TYPE	0.63 MPa	255 l/min
8.3kg ULTRA LIGHT	2700 Nm	4800 min ⁻¹	1/2" 12.5mm
COMPOSITE BODY KOMPONENTOWA OBUDOWA			

- application: industry, service stations, tire service stations, truck service
- the lightest 1" impact wrench with torque of 2700 Nm
- magnesium alloy and composite housing
- low vibration
- low air consumption

- przeznaczenie: przemysł, serwisy mobilne i stacjonarne, serwisy opon oraz pojazdów ciężarowych
- najlżejszy klucz pneumatyczny w klasie 1" o mocy 2700 Nm
- obudowa ze stopów magnezu i kompozytu
- niski poziom wibracji
- małe zużycie powietrza

$L_{pa} = 93.6 \pm 3.0$ dB;
 $L_{wa} = 104.6 \pm 3.0$ dB;
 $a_w = 5.0 \pm 1.5 / 8.6 \pm 1.5$ m/s²

YATO	Nm	
YT-09611	2700	2

GB Pneumatic wrench
D Druckluft-Schlüssel
PL Klucz pneumatyczny
RUS Пневматический ключ
CZ Pneumatiký utahovák
H Pneumatikus kulcs

RO Cheie pneumatica
F Clé à choc pneumatique
I Chiave ad impulsi pneumatica
E Llave neumática
CN 气动扳手



PINLESS HAMMER™

closed hammer cage mechanism prevents breakage from hammer pin damage



BMC & COLOR SLEEVE



$L_{pa} = 97.1 \pm 3.0$ dB;
 $L_{wa} = 108.1 \pm 3.0$ dB;
 $a_w = 13.750 \pm 1.5$ m/s²

YATO	Nm	
YT-09615	3200	1

GB Ratchet air wrench
D Druckluft-Ratschenschrauber
PL Grzechotka pneumatyczna
RUS Пневмотрещотка
CZ Utahovák vzduchový
H Préslevegős behajtó szerszám
RO Antrenor pneumatic
F Clé à cliquet pneumatique

I Chiave a cricchetto pneumatica
E Carraca neumática
CN 气动棘轮扳手

1/4" 6.3mm	0.63 MPa	113 l/min	27 Nm
180 min ⁻¹	360° KROTKI AFIŚCIE ODBIJANIE SIŁY PRĘDKOŚCI	SPEED REGULATOR REGULACJA PRĘDKOŚCI	0.5kg ULTRA LIGHT ULTRALICHTY
COMPOSITE BODY KOMPONENTOWA OBUDOWA			



$L_{pa} = 96 \pm 3$ dB;
 $L_{wa} = 107 \pm 3$ dB;
 $a_w = 3.1 \pm 1.5$ m/s²

COLOR BOX

ULTRA LIGHT

YATO	Nm	
YT-09795	27	20

GB Ratchet air wrench
D Druckluft-Ratschenschrauber
PL Grzechotka pneumatyczna
RUS Пневмотрещотка
CZ Utahovák vzduchový
H Préslevegős behajtó szerszám
RO Antrenor pneumatic
F Clé à cliquet pneumatique

I Chiave a cricchetto pneumatica
E Carraca neumática
CN 气动棘轮扳手

1/2" 12.5mm	0.63 MPa	142 l/min	80 Nm
160 min ⁻¹	360° KROTKI AFIŚCIE ODBIJANIE SIŁY PRĘDKOŚCI	SPEED REGULATOR REGULACJA PRĘDKOŚCI	1.4kg ULTRA LIGHT ULTRALICHTY
COMPOSITE BODY KOMPONENTOWA OBUDOWA			



$L_{pa} = 94 \pm 3$ dB;
 $L_{wa} = 105 \pm 3$ dB;
 $a_w = 2.6 \pm 1.5$ m/s²

COLOR BOX

ULTRA LIGHT

YATO	Nm	
YT-09803	80	12

GB Ratchet air wrench
D Druckluft-Ratschenschrauber
PL Grzechotka pneumatyczna
RUS Пневмотрещотка
CZ Utahovák vzduchový
H Préslevegős behajtó szerszám

RO Antrenor pneumatic
F Clé à cliquet pneumatique
I Chiave a cricchetto pneumatica
E Carraca neumática
CN 气动棘轮扳手

1/2" 12.5mm	0.62 MPa	120 l/min	80 Nm
160 min ⁻¹	STANDARD		



$L_{pa} = 87.6 \pm 1.9$ dB;
 $L_{wa} = 97.7 \pm 2.7$ dB;
 $a_w = 14.83 \pm 1.96$ m/s²

COLOR BOX

YATO	Nm	
YT-0981	80	20

GB Ratchet air wrench
D Druckluft-Ratschenschrauber
PL Grzechotka pneumatyczna
RUS Пневмотрещотка
CZ Utahovák vzduchový
H Préslevegős behajtó szerszám

RO Antrenor pneumatic
F Clé à cliquet pneumatique
I Chiave a cricchetto pneumatica
E Carraca neumática
CN 气动棘轮扳手

1/2" 12.5mm	0.62 MPa	110 l/min	68 Nm
160 min ⁻¹	STANDARD		



$L_{pa} = 93.1 \pm 1.9$ dB;
 $L_{wa} = 104.4 \pm 2.7$ dB;
 $a_w = 19.98 \pm 2.47$ m/s²

COLOR BOX

YATO	Nm	
YT-0980	68	20

- GB Ratchet wrench kit
- D Druckluft-Ratschenschrauber mit Zubehör
- PL Zestaw z grzechotką pneumatyczną
- RUS Пневмотрещетка в наборе
- CZ Klíč ráčnový pneumatický s příslušenstvím
- H Pneumatikus racsnikulcs készlet
- RO Cheie pneumatica cu accesorii
- F Clé à cliquet pneumatique
- I Chiave a cricchetto pneumatica
- E Juego con carraca neumática
- CN 气动棘轮扳手组套

1/2" 12.5mm	OILER POT	0.62 MPa	110 l/min
68 Nm	160 min ⁻¹	STANDARD	CrV



L_{PA} = 93,1 ± 1,9 dB;
L_{WA} = 104,4 ± 2,7 dB;
a_v = 19,98 ± 2,47 m/s²

- 1/2" (12.7 mm), L=75 mm;
- 6 mm x 1/2" (12.7 mm);
- 1/2" (12.7 mm);
- H4, H5, H6, H7, H8;
- T20, T25, T27, T30, T40;
- 5.5, 6.5, 8.0 mm;
- PH2, PH3, PH4;
- 10, 11, 12, 13, 14, 17, 19 mm

BMC & COLOR SLEEVE



YATO	Nm	
YT-0982	68	4

- GB Air grinder
- D Druckluft einhandschleifer
- PL Szlifierka pneumatyczna prosta
- RUS Шлифмашина пневматическая
- CZ Bruska přímá pneumatická
- H Pneumatikus egyenescsiszoló
- RO Polizor pneumatic
- F Mini ponceuse pneumatique
- I Smergliatrice dritta pneumatica
- E Lijadora neumática recta
- CN 气动修磨机

0.62 MPa	160 l/min
20000 min ⁻¹	3 6 mm
STANDARD	



COLOR BOX



L_{PA} = 100,7 ± 2,4 dB;
L_{WA} = 106,2 ± 3,7 dB;
a_v = 2,83 ± 0,93 m/s²

YATO		
YT-0965	68	25

- GB Air grinder
- D Druckluft einhandschleifer
- PL Szlifierka pneumatyczna prosta
- RUS Шлифмашина пневматическая
- CZ Bruska přímá pneumatická
- H Pneumatikus egyenescsiszoló
- RO Polizor pneumatic
- F Mini ponceuse pneumatique
- I Smergliatrice dritta pneumatica
- E Lijadora neumática recta
- CN 气动修磨机

0.63 MPa	113 l/min	ADJUSTABLE SPEED REGULATOR REGULACJA PRĘDKOŚCI
25000 min ⁻¹	6 mm	COMPOSITE BODY KOMPETYTYWNA OBLUSZONA
REAR AIR EXHAUST CAN BE ROTATED 360° MOŻLIWOŚĆ USTAWIENIA WYDMUCHU POWIETRZA O 360°		
STANDARD		



COLOR BOX



L_{PA} = 88,0 ± 3,0 dB;
L_{WA} = 99,0 ± 3,0 dB;
a_v = 2,9 ± 1,5 m/s²

YATO		
YT-09632	68	20

- GB Air grinder
- D Druckluft einhandschleifer
- PL Szlifierka pneumatyczna prosta
- RUS Шлифмашина пневматическая
- CZ Bruska přímá pneumatická
- H Pneumatikus egyenescsiszoló
- RO Polizor pneumatic
- F Mini ponceuse pneumatique
- I Smergliatrice dritta pneumatica
- E Lijadora neumática recta
- CN 气动修磨机

0.63 MPa	113 l/min	25000 min ⁻¹	6 mm
360°	SPEED REGULATOR REGULACJA PRĘDKOŚCI	0.33kg	ULTRA LIGHT ULTRALEKKI
COMPOSITE BODY KOMPETYTYWNA OBLUSZONA			STANDARD



COLOR BOX



L_{PA} = 97,0 ± 3,0 dB;
L_{WA} = 108,0 ± 3,0 dB;
a_v = 0,9 ± 1,5 m/s²

ULTRA LIGHT

YATO		
YT-09633	68	40

15

- GB Pneumatic angle grinder
- D Ruckluft-Winkelschleifer
- PL Szlifierka kątowna pneumatyczna
- RUS Пневматическая угловая шлифовальная машина
- CZ Pneumatické úhlovou brusku
- H Pneumatikus sarokcsiszoló

- RO Polizor unghiular pneumatic
- F Pneumatique meuleuse d'angle
- I Smergliatrice angolare pneumatica
- E Amoladora angular neumática
- CN 气动角磨

0.63 MPa	141 l/min
11000 min ⁻¹	125mm
M10	STANDARD



COLOR BOX



L_{PA} = 87 ± 3 dB;
L_{WA} = 98 ± 3 dB;
a_v = 3,4 ± 1,5 m/s²

YATO		
YT-09675	68	8

- GB Pneumatic angle grinder
- D Ruckluft-Winkelschleifer
- PL Szlifierka kątowna pneumatyczna
- RUS Пневматическая угловая шлифовальная машина
- CZ Pneumatické úhlovou brusku
- H Pneumatikus sarokcsiszoló
- RO Polizor unghiular pneumatic
- F Pneumatique meuleuse d'angle

- I Smergliatrice angolare pneumatica
- E Amoladora angular neumática
- CN 气动角磨

0.63 MPa	113 l/min	20000 min ⁻¹
6 mm	360°	SPEED REGULATOR REGULACJA PRĘDKOŚCI
0.48kg	ULTRA LIGHT ULTRALEKKI	COMPOSITE BODY KOMPETYTYWNA OBLUSZONA
STANDARD		



COLOR BOX



L_{PA} = 92,0 ± 3,0 dB;
L_{WA} = 103,0 ± 3,0 dB;
a_v = 1,4 ± 1,5 m/s²

ULTRA LIGHT

YATO		
YT-09676	68	30

- GB Air sander
D Druckluft-Excenterschleifer
PL Szlifierka pneumatyczna mimośrodowa
RUS Шлифмашинка эксцентриковая пневматическая
CZ Bruska pneumatická
H Pneumatikus polírozó
RO Masina de slefuit pneumatica
F Ponceuse pneumatique
I Smerigliatrice orbitale pneumatica
E Lijadora neumática excéntrica
CN 气动砂磨机

0.63 MPa	113 l/min	20000 min ⁻¹	50 mm	2.5 mm
SPEED REGULATOR REGULACJA PRĘDKOŚCI		0.65 kg	COMPOSITE BODY KOMPONOWANA OBLOWA	
ULTRA LIGHT ULTRALEKKI		ECCENTRIC		STANDARD



L_{pa} = 87 ± 3 dB;
L_{wa} = 98 ± 3 dB;
a_w = 2.3 ± 2.5 m/s²

ULTRA LIGHT

COLOR BOX

YATO YT-09730 20

- GB Air sander
D Druckluft-Excenterschleifer
PL Szlifierka pneumatyczna mimośrodowa
RUS Шлифмашинка эксцентриковая пневматическая
CZ Bruska pneumatická
H Pneumatikus polírozó
RO Masina de slefuit pneumatica
F Ponceuse pneumatique
I Smerigliatrice orbitale pneumatica
E Lijadora neumática excéntrica
CN 气动砂磨机

0.62 MPa	230 l/min	9000 min ⁻¹	150 mm
ECCENTRIC		STANDARD	



L_{pa} = 88.4 ± 2.1 dB;
L_{wa} = 96.2 ± 3.0 dB;
a_w = 3.81 ± 0.87 m/s²

YATO YT-0967 10

- GB Air sander
D Druckluft-Excenterschleifer
PL Szlifierka pneumatyczna mimośrodowa
RUS Шлифмашинка эксцентриковая пневматическая
CZ Bruska pneumatická
H Pneumatikus polírozó
RO Masina de slefuit pneumatica
F Ponceuse pneumatique
I Smerigliatrice orbitale pneumatica
E Lijadora neumática excéntrica
CN 气动砂磨机

0.63 MPa	84 l/min	10500 min ⁻¹	150 mm
ECCENTRIC		VACUUM SYSTEM SYSTEM ODPILANIA	STANDARD



L_{pa} = 90 ± 3 dB;
L_{wa} = 101 ± 3 dB;
a_w = 4.4 ± 2.5 m/s²



COLOR BOX

YATO YT-09740 10

- GB Air sander
D Druckluft-Excenterschleifer
PL Szlifierka pneumatyczna mimośrodowa
RUS Шлифмашинка эксцентриковая пневматическая
CZ Bruska pneumatická
H Pneumatikus polírozó
RO Masina de slefuit pneumatica
F Ponceuse pneumatique
I Smerigliatrice orbitale pneumatica
E Lijadora neumática excéntrica
CN 气动砂磨机

0.63 MPa	84 l/min	12000 min ⁻¹	150 mm
ECCENTRIC		360° POWER AIR EXHAUST	ULTRA LIGHT ULTRALEKKI
STANDARD		STANDARD	



L_{pa} = 90 ± 3 dB;
L_{wa} = 101 ± 3 dB;
a_w = 4.4 ± 2.5 m/s²

YATO YT-09739 10

- GB Air belt sander
D Pneumatische Bandschleifer
PL Pneumatyczna szlifierka taśmowa
RUS Пневматический шлифовальный
CZ Pneumatická pásová bruska
H Pneumatikus szalagcsiszoló
RO Polizor pneumatic cu banda
F Ponceuse à bandes pneumatique
I Nastro per levigatrice pneumatica
E Lijadora de banda neumática
CN 气动砂带机

REGULOWANA GŁOWICA	170 l/min	0.63 MPa	20000 min ⁻¹
EASY BELT REPLACEMENT ŁATWA WYMIANA PASA		STANDARD	



includes belts: /
w zestawie pasy:
P60, P80, P120

L_{pa} = 93 ± 3 dB;
L_{wa} = 104 ± 3 dB;
a_w = 4.8 ± 1.5 m/s²

YATO belt size / rozmiar pasa (mm) YT-09741 10x330 10

- GB Air belt sander
D Pneumatische Bandschleifer
PL Pneumatyczna szlifierka taśmowa
RUS Пневматический шлифовальный
CZ Pneumatická pásová bruska
H Pneumatikus szalagcsiszoló
RO Polizor pneumatic cu banda
F Ponceuse à bandes pneumatique
I Nastro per levigatrice pneumatica
E Lijadora de banda neumática
CN 气动砂带机

REGULOWANA GŁOWICA	200 l/min	0.63 MPa	20000 min ⁻¹
EASY BELT REPLACEMENT ŁATWA WYMIANA PASA		STANDARD	



includes belts: /
w zestawie pasy:
P60, P80, P120

L_{pa} = 93 ± 3 dB;
L_{wa} = 104 ± 3 dB;
a_w = 4.8 ± 1.5 m/s²

YATO belt size / rozmiar pasa (mm) YT-09742 20x520 10

GB Endless sanding belt
D Schleifband
PL Taśma ścierna bezkońcowa

RUS Шлифовальные ленты
CZ Brusný pás
H Csiszoló szalag

RO Bandă de pânză
F Bande abrasives sans fin
I Nastro abrasivo senza fine

E Pano abrasivo cinturón
CN 砂带

HANGING
COLOR BOX



- application: metal, wood
- abrasive: aluminium oxide
- bond: synthetic resin
- coating: close
- zastosowanie: metal, drewno
- ścierniwo: tlenek glinu
- spojwo: żywica syntetyczna
- nasyp pełny

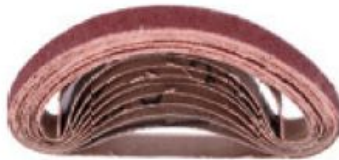

- application: metal, wood
- abrasive: aluminium oxide
- bond: synthetic resin
- coating: close
- zastosowanie: metal, drewno
- ścierniwo: tlenek glinu
- spojwo: żywica syntetyczna
- nasyp pełny

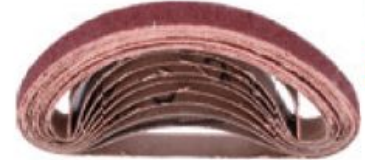

YATO	grit / ziarnistość	size / rozmiar (mm)	PCS packing	
YT-09743	60	10x330	10	100
YT-09744	80	10x330	10	100
YT-09745	100	10x330	10	100
YT-09746	120	10x330	10	100

YATO	grit / ziarnistość	size / rozmiar (mm)	PCS packing	
YT-09747	60	20x520	10	50
YT-09748	80	20x520	10	50
YT-09749	100	20x520	10	50
YT-09750	120	20x520	10	50

GB Air cut-off tool
D Druckluft-Schneidmaschine
PL Przecinarka pneumatyczna
RUS Резак пневматический
CZ Příčná bruska pneumatická
H Pneumatikus sarokcsiszoló

RO Masina de taiat cu aer comprimat
F Coupeuse pneumatique
I Fresa pneumática
E Cortadora neumática
CN 气动切割工具

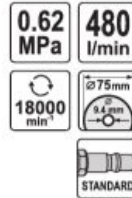

L_{pa} = 97,1 ± 2,4 dB;
L_{wa} = 103,1 ± 3,6 dB;
a₁ = 1,54 ± 0,51 m/s²

COLOR BOX



YATO
YT-0993 20

GB Air cut-off tool
D Druckluft-Schneidmaschine
PL Przecinarka pneumatyczna
RUS Резак пневматический
CZ Příčná bruska pneumatická
H Pneumatikus sarokcsiszoló

RO Masina de taiat cu aer comprimat
F Coupeuse pneumatique
I Fresa pneumática
E Cortadora neumática
CN 气动切割工具



L_{pa} = 77,0 ± 3,0 dB;
L_{wa} = 88,0 ± 3,0 dB;
a₁ = 2,38 ± 1,5 m/s²

COLOR BOX



YATO
YT-09715 10

GB Air cut-off tool
D Druckluft-Schneidmaschine
PL Przecinarka pneumatyczna
RUS Резак пневматический
CZ Příčná bruska pneumatická
H Pneumatikus sarokcsiszoló

RO Masina de taiat cu aer comprimat
F Coupeuse pneumatique
I Fresa pneumática
E Cortadora neumática
CN 气动切割工具



L_{pa} = 90,0 ± 3,0 dB;
L_{wa} = 101,0 ± 3,0 dB;
a₁ = 1,2 ± 1,5 m/s²

ULTRA LIGHT

COLOR BOX



YATO
YT-09717 20

GB Metal cutting disc
D Metall-Trennscheibe
PL Tarcza do cięcia metalu
RUS Круги отрезные по металлу
CZ Souprava kotoučů pro řezání kovu
H Vágókorong fémhez

RO Set de pânze de taiat metal
F Set de disques
I Disco per taglio metallo
E Disco cortador para metal
CN 金属切割片组套



BLISTER CARD

YATO
YT-0994 12/48

for / dla: YT-0993

GB Air body saw
D Luft Körper Säge
PL Wyrzynarka pneumatyczna
RUS Пила пневматическая сабельная
CZ Pilka pneumatická na plech

H Pneumatikus kardfűrész
RO Fierastrau pneumatic
F Scie sabre pneumatique
I Sega da traforo
E Sierra neumática
CN 气锯



L_{pa} = 78 ± 3 dB;
L_{wa} = 89 ± 3 dB;
a₁ = 23 ± 1,5 m/s²

COLOR BOX



YATO
YT-09955 20

GB Jig saw blades
D Sticksägeblätter
PL Brzeszczyty do wyrzynarki
RUS Полотно для станка
CZ Pilový list do přímočaré pily
H Dekopírtap

RO Lama fierastrau pendular
F lame pour scie sauteuse
I lame per seghetti pneumatici
E Recambio sierra de calar
CN 锯片



SLIDING CARD



for / dla: YT-09955

YATO	TPI	
YT-09958	24	50/200
YT-09959	32	50/200

GB Air shears pistol type
D Pneumatische Schere
PL Nożyce pneumatyczne
kątowe
RUS Пневматические
ножницы угловые
CZ Pneumatické nůžky na plech

H Pneumatikus ollók
RO Foarfeca pneumatica
F Cisailles pneumatiques
I Cesoia pneumatica angolare
E Tijera neumática
CN 气动剪刀



$L_{pA} = 80 \pm 3$ dB;
 $L_{wA} = 91 \pm 3$ dB;
 $a_s = 6.5 \pm 1.5$ m/s²

COLOR
BOX

YATO
YT-09944 10

GB Air shears
D Pneumatische Schere
PL Nożyce pneumatyczne
proste
RUS Пневматические
ножницы прямые
CZ Pneumatické nůžky na plech

H Pneumatikus ollók
RO Foarfeca pneumatica
F Cisailles pneumatiques
I Cesoia pneumatica dritta
E Tijera neumática
CN 气动剪刀

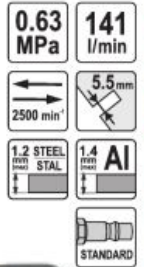

$L_{pA} = 90 \pm 3$ dB;
 $L_{wA} = 101 \pm 3$ dB;
 $a_s = 4.6 \pm 1.5$ m/s²

COLOR
BOX

YATO
YT-09945 15

GB Reversible air drill
D Druckluft-Bohrmaschine
mit Stahl-Zahnkranzfutter
PL Wiertarka pneumatyczna
RUS Пневматическая дрель
CZ Vrtačka ruční vzduchová
H Pneumatikus fúró

RO Masina de gaurit
pneumatica mandrina
F Perceuse pneumatique
I Fresa pneumatica
E Taladradora neumática
CN 双向气钻



$L_{pA} = 87.2 \pm 1.4$ dB;
 $L_{wA} = 99.7 \pm 2.9$ dB;
 $a_s = 3.88 \pm 1.04$ m/s²

COLOR
BOX

YATO
YT-0970 20

GB Reversible air drill
D Druckluft-Bohrmaschine
mit Stahl-Zahnkranzfutter
PL Wiertarka pneumatyczna
RUS Пневматическая дрель
CZ Vrtačka ruční vzduchová
H Pneumatikus fúró

RO Masina de gaurit
pneumatica mandrina
F Perceuse pneumatique
I Fresa pneumatica
E Taladradora neumática
CN 双向气钻



$L_{pA} = 89.7 \pm 3.0$ dB;
 $L_{wA} = 100.7 \pm 3.0$ dB;
 $a_s = 0.89 \pm 1.5$ m/s²

COLOR
BOX

YATO
YT-09702 12

GB Reversible air drill
D Druckluft-Bohrmaschine
mit Stahl-Zahnkranzfutter
PL Wiertarka pneumatyczna
RUS Пневматическая дрель
CZ Vrtačka ruční vzduchová
H Pneumatikus fúró

RO Masina de gaurit
pneumatica mandrina
F Perceuse pneumatique
I Fresa pneumatica
E Taladradora neumática
CN 双向气钻

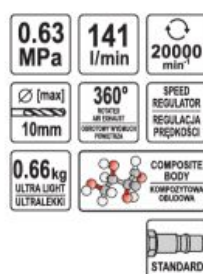

$L_{pA} = 92.0 \pm 3.0$ dB;
 $L_{wA} = 103.0 \pm 3.0$ dB;
 $a_s = 6.2 \pm 1.5$ m/s²

COLOR
BOX

YATO
YT-09695 20

ULTRA LIGHT

GB Reversible air drill
D Druckluft-Bohrmaschine
mit Stahl-Zahnkranzfutter
PL Wiertarka pneumatyczna
RUS Пневматическая дрель
CZ Vrtačka ruční vzduchová
H Pneumatikus fúró

RO Masina de gaurit
pneumatica mandrina
F Perceuse pneumatique
I Fresa pneumatica
E Taladradora neumática
CN 双向气钻

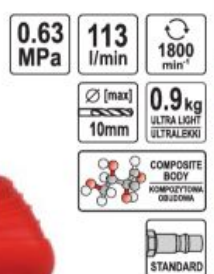

$L_{pA} = 98.0 \pm 3.0$ dB;
 $L_{wA} = 109.0 \pm 3.0$ dB;
 $a_s = 2.8 \pm 1.5$ m/s²

COLOR
BOX

YATO
YT-09703 10

ULTRA LIGHT

GB Air hammer
D Druckluft-Schlaghammer
PL Młotek pneumatyczny
RUS Зубило пневматическое
CZ Sekáč vzduchový
H Pneumatikus vésőkészlet pisztollyal

RO Ciocan pneumatic
F Marteau pneumatique
I Martello pneumatica
E Martillo neumático
CN 气锤

0.62 MPa
113 l/min
3200 min⁻¹
STANDARD

GB Air hammer
D Druckluft-Schlaghammer
PL Młotek pneumatyczny
RUS Зубило пневматическое
CZ Sekáč vzduchový
H Pneumatikus vésőkészlet pisztollyal

RO Ciocan pneumatic
F Marteau pneumatique
I Martello pneumatica
E Martillo neumático
CN 气锤

0.63 MPa
113 l/min
4500 min⁻¹
0.95 kg
ULTRA LIGHT
ULTRALEKKI
COMPOSITE BODY
KOMPOZITONAL TESTŐZŐTÁR



COLOR BOX

YATO 10
YT-0990

L_{WA} = 96,3 ± 1,3 dB;
L_{PA} = 107,7 ± 2,5 dB;
a_w = 32,62 ± 9,10 m/s²



COLOR BOX

YATO 10
YT-09904

L_{WA} = 95 ± 3 dB;
L_{PA} = 106 ± 3 dB;
a_w = 20 ± 4,5 m/s²

ULTRA LIGHT

GB Air needle scaler
D Luft-Nadel-Scaler
PL Pneumatyczny młotek igłowy
RUS Пневматический игольчатый отбойник
CZ Vzduchový jehlový škrabák
H Pneumatikus tűs rozsdaleverő pisztollyal
RO Pistol pneumatic de curățat cu ace
F Dérouilleur décapeur pneumatique
I Scrostatore pneumatico ad aghi
E Limpiador de agujas neumáticas
CN 气动除锈器



COLOR BOX

YATO 8
YT-09910

19 NEEDLES
19 IGHÉL
0.63 MPa
113 l/min
4500 min⁻¹
STANDARD

L_{WA} = 100 ± 3 dB;
L_{PA} = 111 ± 3 dB;
a_w = 13 ± 1,5 m/s²

15

GB Shank chisel for air hammer
D Lufthammer Meißel-set
PL Dłuta do młotka pneumatycznego
RUS Комплект зубил для пневматического молотка
CZ Dláta pro pneumatické kladivo
H Véső készlet pneumatikus véső kalapáchoz
RO Set dalti pt. ciocan

pneumatic
F Ensemble marteau burineur
I Set di scalpelli per martelli pneumatici
E Juego de martillos para martillos neumáticos
CN 气动铲刀

4 PCS
120 mm
ROUND
OKRĄGLE



POLYBAG WITH HEADER



for / dla: YT-0990, 81133

YATO 50
YT-09901

GB Magnetic holder for tools
D Magnethalter für Schlagschrauber
PL Uchwyt magnetyczny na narzędzia
RUS Магнитный держатель для ударного гайковерта
CZ Magnetický držák nářadí
H Mágneses tartó
RO Suport magnetic pt. scule pneumatice
F Support magnétique pour outils pneumatiques
I Fissaggio magnetico per chiave ad impulsi pneumatica
E Soporte magnético para llave de impacto
CN 磁性喷枪架

15 kg max.
MAGNETIC



COLOR BOX

YATO 5/10
YT-08707

- GB Tire-inflating gun
D Reifenfüller
PL Pistolet do pompowania kół
RUS Пистолет для накачивания колёс
CZ Pistolet na čerpání z manometrem
H Gumiabroncs pumpáló
RO Pistol cu manometru pt. pompat

- F Pistolet pour gonflage de pneus avec manomètre
I Pistola per gonfiaggio gomme
E Pistola de bombeo con manometro
CN 轮胎气压表



$L_{pA} = 89 \pm 2.5$ dB;
 $L_{wA} = 100 \pm 2.5$ dB;
 $a_w = < 2.5$ m/s²

YATO
YT-23701 20

- GB Tire-inflating gun
D Reifenfüller
PL Pistolet do pompowania kół
RUS Пистолет для накачивания колёс
CZ Pistolet na čerpání z manometrem
H Gumiabroncs pumpáló
RO Pistol cu manometru pt. pompat
F Pistolet pour gonflage de pneus avec manomètre
I Pistola per gonfiaggio gomme
E Pistola de bombeo con manometro
CN 轮胎气压表



$L_{pA} = 89$ dB;
 $L_{wA} = 100$ dB;
 $a_w = < 2.5$ m/s²

YATO
YT-2370 8/40

- GB Tire-inflating gun
D Reifenfüller
PL Pistolet do pompowania kół
RUS Пистолет для накачивания колёс
CZ Pistolet na čerpání z manometrem
H Gumiabroncs pumpáló
RO Pistol cu manometru pt. pompat
F Pistolet pour gonflage de pneus avec manomètre
I Pistola per gonfiaggio gomme
E Pistola de bombeo con manometro
CN 轮胎气压表



$L_{pA} = 89 \pm 2.5$ dB;
 $L_{wA} = 100 \pm 2.5$ dB;
 $a_w = \leq 2.5$ m/s²

YATO
YT-23703 20

- GB Tire-inflating gun
D Reifenfüller
PL Pistolet do pompowania kół
RUS Пистолет для накачивания колёс
CZ Pistolet na čerpání z manometrem
H Gumiabroncs pumpáló
RO Pistol cu manometru pt. pompat
F Pistolet pour gonflage de pneus avec manomètre

- I Pistola per gonfiaggio gomme
E Pistola de bombeo con manometro
CN 轮胎气压表



$L_{pA} = 89 \pm 2.5$ dB;
 $L_{wA} = 100 \pm 2.5$ dB;
 $a_w = \leq 2.5$ m/s²

YATO
YT-23702 10/40

- GB Inflating head
D Klemmripfel (universal)
PL Głowica do pompowania
RUS Универсальная головка
CZ Hlava na čerpání
H Pumpafej
RO Cap pt. pompat
F Mandrin de pompe
I Testa per il pompaggio
E Cabeza de bombeo
CN 充气头



YATO	Ø (mm)	
YT-2371	6	50/300
YT-2372	8	50/300

- GB Air breake bleeder
D Druckluft-Bremsenlüfter
PL Urządzenie pneumatyczne do wymiany płynu hamulcowego
RUS Устройство для замены тормозной жидкости
CZ Sada na odvzdušnění brzdové soustavy a hydraulické spojky
H Pneumatikus eszköz a fékfolyadék cseréjére
RO Aparat de schimb lichid frână
F Purger de frein et d'embrayage pneumatique
I Strumento per la sostituzione del liquido freni
E Sangrado del freno de aire comprimido
CN 气动刹车油更换机



11 ADAPTERS / 11 ADAPTERÓW



$L_{pA} = \leq 70$ dB;
 $L_{wA} = \leq 85$ dB;
 $a_w = \leq 2.5$ m/s²

GREY CARTON BOX & COLOR LABEL



YATO
YT-06845 1

GB Spray gun with fluid cup
 D Lackierpistole mit Fliessbecher
 PL Pistolet natryskowy
 RUS Пистолет - распылитель с верхним бачком

CZ Pistole na lakování z nádrží
 H Festékszóró pisztoly alsó- és felsőtartályos
 RO Pistol de vopsit cu rezervor inferior
 F Pistolet à peinture

I Pistola vernice
 E Pistola de barniz
 CN 喷枪



1.4 mm
 410 l/min
 0.30 MPa
 0.6 l
 HVLP

L_{pk} = 74 dB;
 L_{mk} = 85 dB;
 a_w = < 2,5 m/s²



1.5 mm
 410 l/min
 0.30 MPa
 0.6 l
 HVLP

L_{pk} = 76 dB;
 L_{mk} = 87 dB;
 a_w = < 2,5 m/s²



1.8 mm
 380 l/min
 0.40 MPa
 1.0 l

L_{pk} = 79 dB;
 L_{mk} = 90 dB;
 a_w = < 2,5 m/s²



0.8 mm
 220 l/min
 0.30 MPa
 0.1 l
 HVLP

L_{pk} = 67 dB;
 L_{mk} = 78 dB;
 a_w = < 2,5 m/s²

YATO 20 YT-2340

YATO 20 YT-2341

YATO 10 YT-2346

YATO 20 YT-2357

GB Inflating gun with extension
 D Gebläsepistole mit Verlängerung
 PL Pistolet do przedmuchiwania z przedłużką
 RUS Пистолет для продувки с удлинителем
 CZ Pistole na profukování dlouhá
 H Rövid előléfűvő pisztoly
 RO Pistol lung pt. suflat
 F Pistolet pour purger
 I Pistola professionale
 E Pistola de soplado
 CN 长杆充气枪

1/4" 6.3mm
 0.8 MPa (max.)
 AI
 25 mm 215 mm
 STANDARD

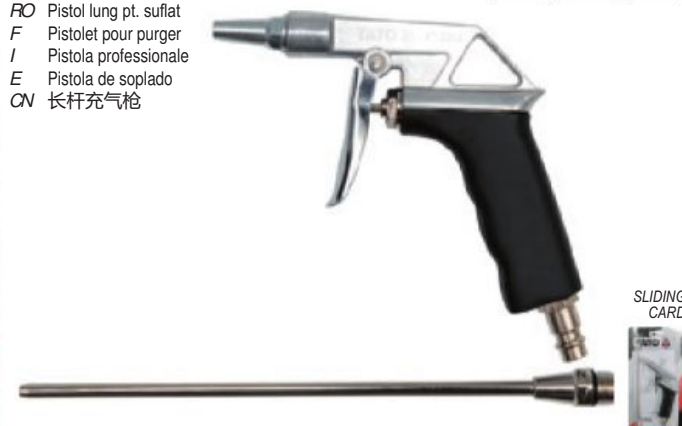

L_{pk} = 91 dB;
 L_{mk} = 102 dB;
 a_w = < 2,5 m/s²

YATO 20/40 YT-2373

GB Inflating gun with extension
 D Gebläsepistole mit Verlängerung
 PL Pistolet do przedmuchiwania z przedłużką
 RUS Пистолет для продувки с удлинителем
 CZ Pistole na profukování dlouhá
 H Rövid előléfűvő pisztoly
 RO Pistol lung pt. suflat
 F Pistolet pour purger
 I Pistola professionale
 E Pistola de soplado
 CN 长杆充气枪

0.8 MPa (max.)
 BRASS MOSIADZ
 PP
 110 mm
 STANDARD



L_{pk} = 89 dB;
 L_{mk} = 100 dB;
 a_w = < 2,5 m/s²

YATO 20/40 YT-23731

15

GB Inflating gun with extension
 D Gebläsepistole mit Verlängerung
 PL Pistolet do przedmuchiwania z przedłużką
 RUS Пистолет для продувки с удлинителем
 CZ Pistole na profukování dlouhá
 H Rövid előléfűvő pisztoly
 RO Pistol lung pt. suflat
 F Pistolet pour purger
 I Pistola professionale
 E Pistola de soplado
 CN 长杆充气枪



0.8 MPa (max.)
 320 mm
 PP
 BRASS MOSIADZ
 STANDARD

L_{pk} = 89 ± 2,5 dB;
 L_{mk} = 100 ± 2,5 dB;
 a_w = < 2,5 m/s²



YATO 30/60 YT-23732

GB Inflating gun with extension
 D Gebläsepistole mit Verlängerung
 PL Pistolet do przedmuchiwania z przedłużką
 RUS Пистолет для продувки с удлинителем
 CZ Pistole na profukování dlouhá
 H Rövid előléfűvő pisztoly
 RO Pistol lung pt. suflat

F Pistolet pour purger
 I Pistola professionale
 E Pistola de soplado
 CN 长杆充气枪

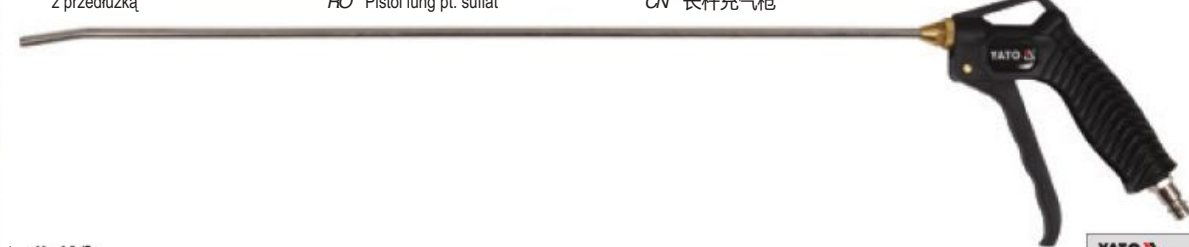

0.8 MPa (max.)
 520 mm
 PP
 BRASS MOSIADZ
 STANDARD

L_{pk} = 89 ± 2,5 dB;
 L_{mk} = 100 ± 2,5 dB;
 a_w = < 2,5 m/s²



YATO 30/60 YT-23733

GB Washing gun
D Waschpistole
PL Pistolet do rogowania
RUS Пистолет для нефтеставания
CZ Pistole na rogování + nádrž
H Olajópisztoly + tartály

RO Pistol (dozator) cu rezervor pt. motorină
F Pistolet à l'huile
I Pistola di lavaggio con nafta
E Pistola de petrolcar
CN 喷水枪

0.85l
130 l/min
AI
0.80 MPa



L_{WA} = 92 dB;
L_{WA} = 103 dB;
a_a = < 2.5 m/s²

YATO
YT-2374 2/12

GB Air sand blaster
D Pistole zum Sandstrahlen
PL Pistolet do piaskowania z wężem
RUS Пескоструйный пистолет
CZ Pískovací pistole s hadicí
H Homokszóró pisztoly tömlővel
RO Pistol de sablat

F Pistolet de sablage avec tuyau
I Pistola sabbiatrica
E Pistola para limpeza con chorro de arena con manguera
CN 吹气枪

1/4"
6.3mm
1m HOSE WAZ
AI

160 l/min
0.80 MPa



L_{WA} = 90 dB;
L_{WA} = 101 dB;
a_a = < 2.03 m/s²

YATO
YT-2375 10

SLIDING CARD



GB Gun suitable for sand-blasting
D Sandstrahlpistole
PL Pistolet do piaskowania ze zbiornikiem
RUS Пескоструйный пистолет
CZ Pískovací pistole se zásobníkem
H Homokszóró pisztoly tartállyal
RO Pistol de sablat
F Pistolet de sablage avec réservoir
I Pistola sabbiatrica con serbatoio
E Pistola para limpeza con chorro de arena con recip
CN 喷枪

1.0l
160 l/min
0.80 MPa
AI



L_{WA} = 91 dB;
L_{WA} = 102 dB;
a_a = < 2.03 m/s²

YATO
YT-2376 20

GB Work bench
D Lackierständer, verstellbar
PL Stojak lakierniczy rozstawny
RUS Раздвижная лакировочная стойка
CZ Stojan lakýrnický rozkládací
H Kinyitható lakkozó állvány
RO Suport extensibil pt. lacuit
F Support à peindre
I Supporto pieghevole
E Montante plegable para barnizar
CN 工作台

10 kg max
85 cm
50 cm

150 kg max
45 cm
100 cm



YATO
YT-5555 1

GB Mini filter
D Filter
PL Filtr
RUS Мини-фильтр
CZ Filtr
H Szűrő
RO Minifiltru
F Vidange mini
I Filtro
E Filtro
CN 微型过滤器

1.4 MPa (max.)
8 cm³
1/4"
6.3mm



YATO
YT-2380 25/50

GB Pressure reducing valve with manometer
D Druckminderer mit Manometer
PL Reduktor ciśnienia z manometrem
RUS Клапан уменьшения давления с манометром
CZ Redukční ventil s manometrem
H Nyomáscsökkentő szelep nyomásmérővel
RO Valva cu reductiepresiune + manometru
F Réducteur avec manomètre
I Regolatore di pressione con manometro
E Reductor + manometro
CN 带表调压减压阀

1.2 MPa (max.)
1/4"
6.3mm



YATO
YT-2381 25/50

GB Filter - reducer
D Druckfilter
PL - Druckminderer
PL Filtr - reduktor
RUS Фильтр - редуктор
CZ Filtr derukční ventil
H Szűrő - nyomásszabályzó
RO Filtru cu reductor
F Réducteur avec filtre et manomètre
I Filtro regolatore
E Reductor + filtro
CN 过滤器

0.93 MPa (max.)
15 cm³
60°C max.
1/4"
6.3mm



YATO
YT-2382 25/50

- GB Filter - reducer
- D Druckfilter - Druckminderer
- PL Filtr - reduktor
- RUS Фильтр - редуктор
- CZ Filtr derukční ventil
- H Szűrő - nyomásszabályzó
- RO Filtru cu reductor
- F Réducteur avec filtre et manomètre
- I Filtro regolatore
- E Reductor + filtro
- CN 过滤器



- 0.93 MPa (max.)
- 90 cm³
- 60°C max.
- 1/2"
- 12.5mm

YATO YT-2383 25/50

- GB Air filter regulator and lubricator
- D Druckfilter - Druckminderer + Entöler
- PL Zespół filtrujący reduktor + smarownica
- RUS Фильтр-редуктор
- CZ Redukční ventil s odlučovačem oleje
- H Levegőelőkészítő
- RO Filtru cu reductor
- F Filtre régulateur lubrificateur pour air comprimé
- I Filtro regolatore lubrificatore
- E Juego de filtro reductor + engrasador
- CN 气动三联件



- 0.93 MPa (max.)
- 25 cm³ FILTER
- 15 cm³ LUBRICANT CUP SMAROWNICA
- 60°C max.
- 1/4"
- 6.3mm

YATO YT-2384 25/50

- GB Air filter regulator and lubricator
- D Druckfilter - Druckminderer + Entöler
- PL Zespół filtrujący reduktor + smarownica
- RUS Фильтр-редуктор
- CZ Redukční ventil s odlučovačem oleje
- H Levegőelőkészítő
- RO Filtru cu reductor
- F Filtre régulateur lubrificateur pour air comprimé
- I Filtro regolatore lubrificatore
- E Juego de filtro reductor + engrasador
- CN 气动三联件



- 0.93 MPa (max.)
- 90 cm³ FILTER
- 60 cm³ LUBRICANT CUP SMAROWNICA
- 60°C max.
- 1/4"
- 6.3mm

YATO YT-2385 25

- GB Spiral tube with quick coupling
- D Spiralschlauch mit Schnellkupplung
- PL Wąż spiralny z szybkozłączem
- RUS Шланг спиральный с быстрым соединением
- CZ Spirálová vzduchová hadice
- H Levegős spiráltömlő gyorscsatlakozóval
- RO Tub spiralat cu cuplare rapida
- F Tuyau spirale en polyurethane
- I Tubo a spirale con rapido
- E Manguera espiral
- CN PU气管



- PU
- 1.2 MPa (max)
- STANDARD

YATO	Ø (mm)	L (mm)	
YT-24201	5.5x8	5	50
YT-24202	5.5x8	10	25
YT-24203	5.5x8	15	25
YT-24204	6.5x10	5	50
YT-24205	6.5x10	10	25
YT-24206	6.5x10	15	25
YT-24207	8x12	5	50
YT-24208	8x12	10	25
YT-24209	8x12	15	20

- GB Air hose with quick coupler
- D Luftschlauch mit Schnellkupplung
- PL Wąż techniczny zbrojony z szybkozłączami
- RUS Шланг пневматический с быстроразъемным соединением
- CZ Hadice vzduchová s rychlospojkami
- H Levegőtömlő apa csatlakozóval
- RO Furtun aer comprimat cuple rapide
- F Le tuyau d'air avec raccords rapides
- I Rinforzato tecnico tubo flessibile con rapido
- E Manguera de aire del con los acopladores rápidos
- CN PVC气管



- PVC
- 2.0 MPa (max)
- STANDARD

YATO	Ø (mm)	L (mm)	
YT-24220	8	10	10
YT-24221	8	20	8
YT-24224	10	10	10
YT-24225	10	20	8

15

- GB Air hose reel
- D Luftschlauch am Haspel
- PL Wąż pneumatyczny na zwijaku
- RUS Шланг пневматический на катушке
- CZ Naviják se vzduchovou hadicí
- H Levegő tömlő dob es
- RO Furtun de aer tumbur
- F Bobine de tuyau d'air et de
- I Tubo pneumatico sull'avvolgitore
- E Carrete de manguera de aire
- CN 气动软管卷盘



- 15m
- Ø 10 mm
- 2.0 MPa (max)
- PVC
- STANDARD

EASILY MOUNTS TO WORKBENCH OR WALL
LATWY MONTAŻ DO STOLU ROBOCZEGO LUB ŚCIANY

INCLUDES 4 ANCHORS
ZAWIERA 4 KOTWY

YATO YT-24240 2

- GB Air hose reel
- D Luftschlauch am Haspel
- PL Wąż pneumatyczny na zwijaku
- RUS Шланг пневматический на катушке
- CZ Naviják se vzduchovou hadicí
- H Levegő tömlő dob es
- RO Furtun de aer tumbur
- F Bobine de tuyau d'air et de
- I Tubo pneumatico sull'avvolgitore
- E Carrete de manguera de aire
- CN 气动软管卷盘



- 15m
- Ø 9.5 mm
- 2.0 MPa (max)
- PVC + NBR HYBRID
- STANDARD

EASILY MOUNTS TO WORKBENCH OR WALL
LATWY MONTAŻ DO STOLU ROBOCZEGO LUB ŚCIANY

INCLUDES 4 ANCHORS
ZAWIERA 4 KOTWY

YATO YT-24241 2

GB Air hose reel
D Luftschauch am Haspel
PL Waż pneumatyczny na zwijaku
RUS Шланг пневматический на катушке
CZ Naviják se vzduchovou hadicí
H Levegő tömlő dob es

RO Furtun de aer tumbur
F Bobine de tuyau d'air et de
I Tubo pneumatico sull'avvolgitore
E Carrete de manguera de aire
CN 气动软管卷盘



EASILY MOUNTS TO WORKBENCH OR WALL
ŁATWY MONTAŻ DO STOŁU ROBOCZEGO LUB ŚCIANY
INCLUDES 4 ANCHORS
ZAWIERA 4 KOTWY



YATO YT-24242 4

GB Air hose reel
D Luftschauch am Haspel
PL Waż pneumatyczny na zwijaku
RUS Шланг пневматический на катушке
CZ Naviják se vzduchovou hadicí
H Levegő tömlő dob es

RO Furtun de aer tumbur
F Bobine de tuyau d'air et de
I Tubo pneumatico sull'avvolgitore
E Carrete de manguera de aire
CN 气动软管卷盘



EASILY MOUNTS TO WORKBENCH OR WALL
ŁATWY MONTAŻ DO STOŁU ROBOCZEGO LUB ŚCIANY
INCLUDES 4 ANCHORS
ZAWIERA 4 KOTWY



YATO YT-24243 4

GB Quick coupler
D Schnellkupplung
PL Szybkozłącze

RUS Быстрое соединение
CZ Rychlospojka
H Gyorscsatlakozó

RO Mufa rapida pt. pistol pneumatic
F Raccord rapide
I Attacco rapido

E Conexión de la entrada de aire
CN 快速接头

SLIDING CARD

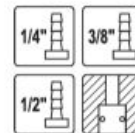
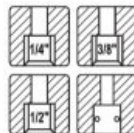
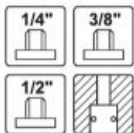

YATO	size / rozmiar	
YT-2390	1/4" (6.3 mm)	50/250
YT-2391	3/8" (10.0 mm)	50/250
YT-2392	1/2" (12.5 mm)	50/250

YATO	size / rozmiar	
YT-2393	1/4" (6.3 mm)	50/250
YT-2394	3/8" (10.0 mm)	50/250
YT-2395	1/2" (12.5 mm)	50/250

YATO	size / rozmiar	
YT-2396	1/4" (6.3 mm)	50/250
YT-2397	3/8" (10.0 mm)	50/250
YT-2398	1/2" (12.5 mm)	50/250

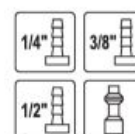
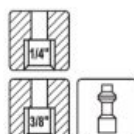
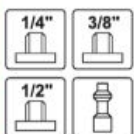

YATO	size / rozmiar	
YT-2399	1/4" (6.3 mm)	50/250
YT-2401	3/8" (10.0 mm)	50/250
YT-2402	1/2" (12.5 mm)	50/250

YATO	size / rozmiar	
YT-2403	1/4" (6.3 mm)	50/250
YT-2404	3/8" (10.0 mm)	50/250

YATO	size / rozmiar	
YT-2405	1/4" (6.3 mm)	50/250
YT-2406	3/8" (10.0 mm)	50/250
YT-2407	1/2" (12.5 mm)	50/250

GB Quick coupler
D Schnellkupplung
PL Szybkozłącze

RUS Быстрое соединение
CZ Rychlospojka
H Gyorscsatlakozó

RO Mufa rapida pt. pistol pneumatic
F Raccord rapide
I Attacco rapido

E Conexión de la entrada de aire
CN 快速接头

DOUBLE BLISTER

2 PCS
STANDARD



YATO YT-24100 6/60

YATO YT-24101 6/60



YATO YT-24102 6/60

YATO YT-24103 6/60

- GB 2 way quick coupler
- D Zwei-wege schnelkupplung
- PL Szybkozłącze podwójne
- RUS Двусторонняя быстроразъемные соединения
- CZ Two-way rychlospojky
- H Levegőelosztó kettes gyorscsatlakozás
- RO Distribuitoare cuple rapide
- F Dérivation type y en cuivre
- I Raccordo ottone con vie
- E Manera 2 manguera de aire pase de acoplamiento rápido
- CN 三通万用插嘴



SLIDING CARD



YATO
YT-24091 25/50

- GB Quick coupler
- D Schnellkupplung
- PL Szybkozłącze
- RUS Быстрое соединение
- CZ Rychlospojka
- H Gyorscsatlakozó
- RO Mufta rapida pt. pistol pneumatic
- F Raccord rapide
- I Attacco rapido
- E Conexión de la entrada de aire
- CN 快速接头



YATO
YT-24092 50/100



YATO
YT-24093 50/100



YATO
YT-24094 50/100



YATO
YT-24095 50/100

- GB Air grease gun
- D Druckluft-Fettpresse
- PL Smarownica pneumatyczna
- RUS Шприц для нагнетания густой смазки пневматический
- CZ Mazací lis pneumatický
- H Pneumatikus zsírzó
- RO Pistol pt. gresat pneumatic
- F Pistolet de graissage pneumatique
- I Pneumatica per ingrassaggio
- E Pistola engrasadora neumática
- CN 气动黄油枪



OUT: 30-40 MPa



IN: 0.2-0.8 MPa

COLOR BOX



YATO
YT-07055 10

$L_{pa} = 93 \pm 3$ dB;
 $L_{wa} = 104 \pm 3$ dB;
 $a_s = \leq 2.5$ m/s²

- GB Air grease gun
- D Druckluft-Fettpresse
- PL Smarownica pneumatyczna
- RUS Шприц для нагнетания густой смазки пневматический
- CZ Mazací lis pneumatický
- H Pneumatikus zsírzó
- RO Pistol pt. gresat pneumatic
- F Pistolet de graissage pneumatique
- I Pneumatica per ingrassaggio
- E Pistola engrasadora neumática
- CN 气动黄油枪



OUT: 6-28 MPa



IN: 0.2-0.63 MPa

COLOR BOX



YATO
YT-07057 10

$L_{pa} = \leq 70$ dB;
 $L_{wa} = \leq 80$ dB;
 $a_s = \leq 2.5$ m/s²



YATO
YT-07067 1

GREY CARTON BOX & COLOR LABEL



$L_{pa} = 97 \pm 3$ dB;
 $L_{wa} = 108 \pm 3$ dB

GB Pneumatic riveting machine
D Pneumatische Nietvorrichtung
PL Nitownica pneumatyczna
RUS Пневматический заклепочник
CZ Pneumatická nýtovačka
H Pneumatikus popszegecshúzó

RO Presa pneumatica pt. nituit
F Riveuse pneumatique
I Rivettatrice pneumatica
E Máquina remachadora
CN 气动拉铆枪



$L_{pA} = 83.6 \pm 1.9$ dB;
 $L_{pM} = 97.4 \pm 2.8$ dB;
 $a_s = 0.66 \pm 0.21$ m/s²

COLOR BOX

YATO	Ø (mm)	L (mm)	F (kg)	F (N)	
YT-36171	2.4; 3.2; 4.0; 4.8; 5.0	18	1060	10400	10

GB Pneumatic riveting machine
D Pneumatische Nietvorrichtung
PL Nitownica pneumatyczna
RUS Пневматический заклепочник
CZ Pneumatická nýtovačka
H Pneumatikus popszegecshúzó

RO Presa pneumatica pt. nituit
F Riveuse pneumatique
I Rivettatrice pneumatica
E Máquina remachadora
CN 气动拉铆枪

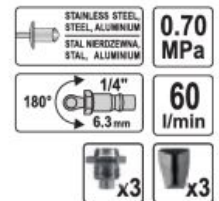

$L_{pA} = 87.2 \pm 2.3$ dB;
 $L_{pM} = 94.5 \pm 3.0$ dB;
 $a_s = 0.54 \pm 0.15$ m/s²

COLOR BOX

YATO	Ø (mm)	L (mm)	F (kg)	F (N)	
YT-36177	4.0; 4.8; 5.0; 6.4	20	1255	12300	10

GB Pneumatic riveting machine
D Pneumatische Nietvorrichtung
PL Nitownica pneumatyczna
RUS Пневматический заклепочник
CZ Pneumatická nýtovačka
H Pneumatikus popszegecshúzó

RO Presa pneumatica pt. nituit
F Riveuse pneumatique
I Rivettatrice pneumatica
E Máquina remachadora
CN 气动拉铆枪



• application: industry
• przeznaczenie: przemysł

$L_{pA} = 81.2 \pm 3.0$ dB;
 $L_{pM} = 92.1 \pm 3.0$ dB;
 $a_s = 0.6 \pm 0.56$ m/s²

COLOR BOX

YATO	Ø (mm)	L (mm)	F (kg)	F (N)	
YT-3618	2.4; 3.2; 4.0; 4.8; 6.4	16	1389	13620	6

GB Pneumatic stitching machine
D Druckluftheft
PL Zszywacz pneumatyczny
RUS Пневматический сшиватель
CZ Pneumatická sešivačka
H Pneumatikus tűzőgép

RO Capsator pneumatic
F Agrafeuse pneumatique
I Cucitrice pneumatica
E Engrapadora pneumatica
CN 气动码钉枪

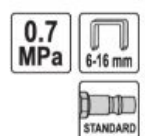

$L_{pA} = 88 \pm 2.5$ dB;
 $L_{pM} = 99 \pm 2.5$ dB;
 $a_s = 3.5 \pm 1.5$ m/s²

COLOR BOX

YATO	
YT-09201	10

GB Pneumatic stitching machine
D Drucklufthefter
PL Zszywacz pneumatyczny
RUS Пневматический шиватель
CZ Pneumatická sešivačka
H Pneumatikus tűzőgép

RO Capsator pneumatic
F Agrafeuse pneumatique
I Cucitrice pneumatica
E Engrapadora pneumática
CN 气动码钉枪



COLOR BOX



$L_{pa} = 88,6 \pm 2,5$ dB;
 $L_{ma} = 101,6 \pm 2,5$ dB;
 $a_s = 2,98 \pm 1,5$ m/s²

YATO	
YT-09202	10

GB Pneumatic stitching machine
D Drucklufthefter
PL Zszywacz pneumatyczny
RUS Пневматический шиватель
CZ Pneumatická sešivačka
H Pneumatikus tűzőgép

RO Capsator pneumatic
F Agrafeuse pneumatique
I Cucitrice pneumatica
E Engrapadora pneumática
CN 气动码钉枪

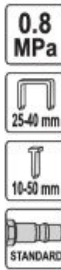

COLOR BOX



$L_{pa} = 87,8 \pm 2,5$ dB;
 $L_{ma} = 100,8 \pm 2,5$ dB;
 $a_s = 2,91 \pm 1,5$ m/s²

YATO	
YT-09203	10

GB Pneumatic roofing coil nailer
D Pneumatischer Coilnagler für Innenausbau
PL Gwoździarka bębnowa na gwoździe papowe
RUS Пневматический нейлер для гвоздей
CZ Pneumatická hřebíkovačka na šindele
H Pneimatiskā naglošanas ierīce

RO Pistol pneumatic cu bobină pt. bătut cuie pe acoperiș
F Cloueuse de charpente pneumatique à bandes
I Cucitrice pneumatica
E Clavadora neumática de bobina para tejados
CN 气动屋顶枪



COLOR BOX



$L_{pa} = 100,3 \pm 2,5$ dB;
 $L_{ma} = 111,3 \pm 2,5$ dB;
 $a_s = 11,3 \pm 1,5$ m/s²

YATO	
YT-09211	3

GB Pneumatic roofing coil nailer
D Pneumatischer Coilnagler für Innenausbau
PL Gwoździarka bębnowa na gwoździe papowe
RUS Пневматический нейлер для гвоздей
CZ Pneumatická hřebíkovačka na šindele
H Pneimatiskā naglošanas ierīce

RO Pistol pneumatic cu bobină pt. bătut cuie pe acoperiș
F Cloueuse de charpente pneumatique à bandes
I Cucitrice pneumatica
E Clavadora neumática de bobina para tejados
CN 气动屋顶枪

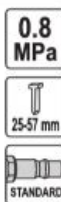

COLOR BOX



$L_{pa} = 88,6 \pm 2,5$ dB;
 $L_{ma} = 101,6 \pm 2,5$ dB;
 $a_s = 3,73 \pm 0,8$ m/s²

YATO	
YT-09212	3

GB Pneumatic roofing coil nailer
D Pneumatischer Coilnagler für Innenausbau
PL Gwoździarka bębnowa na gwoździe papowe
RUS Пневматический нейлер для гвоздей
CZ Pneumatická hřebíkovačka na šindele
H Pneimatiskā naglošanas ierīce

RO Pistol pneumatic cu bobină pt. bătut cuie pe acoperiș
F Cloueuse de charpente pneumatique à bandes
I Cucitrice pneumatica
E Clavadora neumática de bobina para tejados
CN 气动屋顶枪



COLOR BOX



$L_{pa} = 90,8 \pm 2,5$ dB;
 $L_{ma} = 103,8 \pm 2,5$ dB;
 $a_s = 4,09 \pm 0,9$ m/s²

YATO	
YT-09213	3

GB Pneumatic roofing coil nailer
D Pneumatischer Coilnagler für Innenausbau
PL Gwoździarka bębnowa na gwoździe papowe
RUS Пневматический нейлер для гвоздей
CZ Pneumatická hřebíkovačka na šindele
H Pneimatiskā naglošanas ierīce

RO Pistol pneumatic cu bobină pt. bătut cuie pe acoperiș
F Cloueuse de charpente pneumatique à bandes
I Cucitrice pneumatica
E Clavadora neumática de bobina para tejados
CN 气动屋顶枪



COLOR BOX



$L_{pa} = 92,3 \pm 2,5$ dB;
 $L_{ma} = 105,3 \pm 2,5$ dB;
 $a_s = 5,37 \pm 1,5$ m/s²

YATO	
YT-09214	2



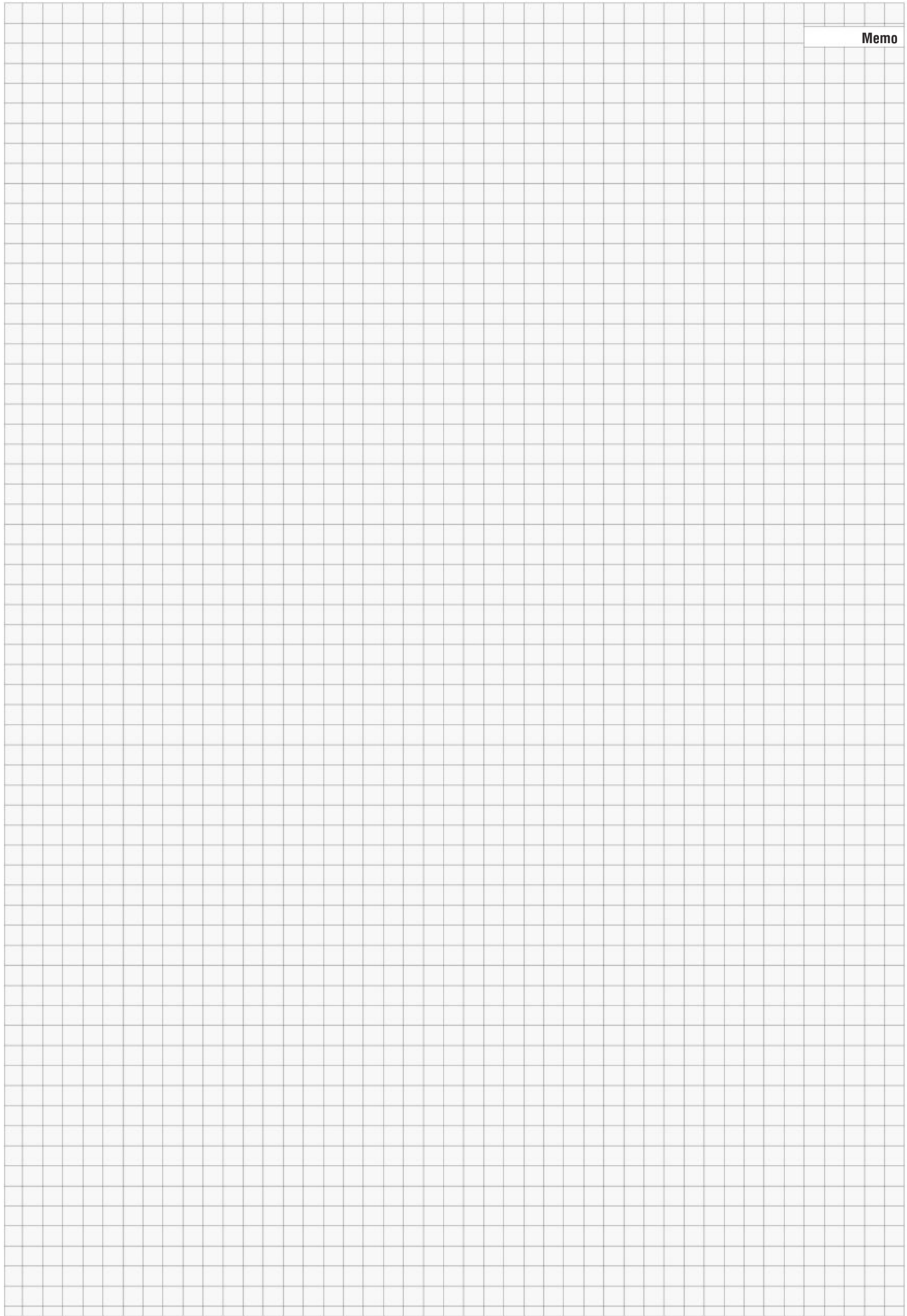









Memo



16

Special automotive tools & equipment
Narzędzia i wyposażenie
warsztatu samochodowego



Cabinets Szafki		Engine repair and diagnostic tools Narzędzia do diagnostyki i naprawy silników	334
289-308		Spark plug sockets Klucze do świec	348
Roller cabinets with tools insert Szafki serwisowe z narzędziami	289	Brake system tools Narzędzia do obsługi układu hamulcowego	
Tool cabinets Szafki serwisowe	295	349-354	
Workbenches Stoły warsztatowe	298	Suspension system tools Narzędzia do obsługi podwozia	
Tools in PVC trays Zestawy narzędzi do szuflad	299	354-358	
Accessories for tool cabinets & workbenches Akcesoria do szafek i stołów	305		
Hermetic tool boxes Walizki narzędziowe hermetyczne		Spring clamps & accessories Ściągacze do sprężyn i akcesoria	354
308		Shock absorber nut sets Zestawy nasadek do amortyzatorów	355
Tool boxes Skrzynki narzędziowe		Tire valve stem inserter Przeciągacze do zaworów gumowych	355
309-310		Wheel balance pliers Szczypce do wyważania kół	356
Lubrication system tools Narzędzia do obsługi układu smarowania		Deep thin wall impact sockets 1/2" Udarowe klucze nasadowe 1/2" do felg aluminiowych	356
310-316		Valve core torque tools Klucze dynamometryczne do zaworków gumowych i metalowych	356
Oil filter wrenches & sets Klucze do filtra oleju i zestawy	310	Wheel wrenches Klucze do kół	356
Oil drain plug sockets Klucze do spustu oleju	312	Impact wrenches Klucze udarowe	357
Grease guns & accessories Smarownice ręczne, pneumatyczne i akcesoria	313	Tire levels Łyżki do opon	358
Oil cans Oliwiarki	316	Workshop tools Narzędzia warsztatowe	
Oil and fuel pumps Pompy do oleju oraz paliwa	316	358-369	
Pullers Ściągacze		Inspection tools Narzędzia inspekcyjne	358
317-327		Magnetic pick up tools Chwytki magnetyczne	358
Pullers Ściągacze	317	Magnetic trays Tacki magnetyczne	359
Roller stud extractor sets Zestawy ściągaczy do szpilek	322	Tweezers Pęsety	359
Upholstery removers Ściągacze do tapicerki	327	Workshop creepers Leżanki warsztatowe	360
Car window tools Narzędzia do szyb samochodowych		LED workshop lightning Oświetlenie warsztatowe LED	360
327-329		Flashlights Latarki	366
Fuel feel pipe pliers Szczypce motoryzacyjne		Voltage testers Próbniki napięcia	367
329-333		Number & letter stamps Znaczniki cyfrowe i literowe	368
Engine repair tools Narzędzia do obsługi silnika		Thread repair sets & accessories Zestawy do naprawy gwintów i akcesoria	368
333-348		Tire pressure gauges Mierniki ciśnienia	368
Piston ring compressors Zaciskacze do pierścieni	333	Pumps Pompy	369
Honing machines & accessories Honownice i akcesoria	334	Air wedges Poduszki montażowe	369
Funnels, oil drainer & drainer pans Lejki, miski i zlewarki do oleju		369-370	
Bottle & floor jacks Dźwigniki słupkowe i podnośniki		371-373	



Vehicle ramps & jack stands
Najazdy i podstawki pod samochód

373



Electric hoists
Elektryczne wciągarki linowe

377



Battery chargers, jump starters, power inverters & battery testers
Prostowniki, urządzenia rozruchowe, przetwornice napięcia i testety akumulatorów

373-376



Hand pullers
Wciągarki linowe, ręczne

378



Refractometers
Refraktometry

376



Transmission jacks
Podnośniki skrzyni biegów

378



Chain blocks
Wciągarki łańcuchowe

377



Shop cranes & shop presses
Żurawie i prasy warsztatowe

378-379



Lever blocks
Wciągarki łańcuchowe dźwigniowe

377



Workshop standardized parts
Normalia motoryzacyjne

380-388



GB Service tool cabinet with tools
D Serviceschrank mit Werkzeugen
PL Szafka serwisowa z narzędziami
RUS Сервисный шкаф с инструментами
CZ Servisní skříňka s nářadím
H Szervizszekrény szerszámmal

RO Dulap echipat cu scule
F Servante d'atelier - set d'outils
I Armadio per utensili
E Armario para herramientas de servicio
CN 工具车托盘组套

GREY
CARTON BOX
& COLOR LABEL



DRAWER / SZUFLADA 1

DRAWER / SZUFLADA 2

DRAWER / SZUFLADA 3



8, 9, 10, 11, 12, 13, 14, 15, 16, 17, 18, 19, 21 mm; CrV;
8x10, 11x12, 13x14, 15x17 mm; CrV 6140;
1/2" (12.7 mm) (F) x 3/8" (9.5 mm) (M); CrV 50BV30;
3/8" (9.5 mm); 63-120 mm; CrV; #;
200 mm; 140 mm;
190-770 mm; 100 mm;
6-24 V; 1.5 V; 9 LED

1/2" (12.7 mm); 20, 22, 24 mm (L=38 mm); 27, 30, 32 mm (L=42 mm); 3/8" (9.5 mm); 9, 10, 11, 12, 13, 14, 15, 16 mm (L=28 mm); 17, 18, 19 mm (L=30 mm); 1/4" (6.3 mm); 4, 5, 6, 7, 8, 9, 10, 11, 12, 13 mm (L=25 mm); CrV 50BV30; 1/4" (6.3 mm); 8, 10, 11, 12 (L=50 mm); CrV 50BV30; 1/2" (12.7 mm); 10, 12, 13, 14, 17, 19 mm (L=78 mm); 12 pt; CrV 50BV30; 1/2" (12.7 mm); 17, 19, 21 mm (L=39 mm); CrMo SCM-440; 3/8" (9.5 mm); E10, E12, E14, E16, E18 (L=28 mm); 1/4" (6.3 mm); E4, E5, E6, E7, E8 (25 mm); CrV 6150; 1/2" (12.7 mm); (127, 254 mm); 3/8" (9.5 mm); (76, 152.4 mm); 1/4" (6.3 mm); (50.8 mm); CrV 50BV30; 3/8" (9.5 mm) (F) x 1/2" (12.7 mm) (M); CrV 50BV30; 1/2" (12.7 mm); 3/8" (9.5 mm); 1/4" (6.3 mm); CrV 50BV30; 3/8" (9.5 mm); 16, 21 mm; CrV 50BV30; 3/8" (9.5 mm); 14 mm; 12 pt; CrV; 1/2" (12.7 mm); (255 mm); 3/8" (9.5 mm); (200 mm); 1/4" (6.3 mm); (155 mm); 72T; CrV 6140; 1/4" (6.3 mm); (150 mm); CrV 50BV30; 3/8" (9.5 mm) x 5/16" (7.9 mm); CrV 6140; 1/4" (6.3 mm) x 1/4" (6.3 mm); CrV 6140; 5/16" (7.9 mm); 5.5, 6.5 mm (L=70 mm); 1/4" (6.3 mm); 4, 5, 6 mm (L=25 mm); AISI S2; 5/16" (7.9 mm); PH1 x2, PH2 x2, PH3 (L=70 mm); 1/4" (6.3 mm); PH1x2, PH2x2, PH3 (L=25 mm); AISI S2; 1/4" (6.3 mm); T10, T15, T20, T25, T27, T30, T40 (L=70 mm); AISI S2; 5/16" (7.9 mm); T20, T30, T40, T45, T50, T55, T60 (L=70 mm); AISI S2; 5/16" (7.9 mm); 4, 5, 6, 7, 8 mm (L=70 mm); 1/4" (6.3 mm); 3, 4, 5, 6, 7 mm (L=25 mm); AISI S2; 5/16" (7.9 mm); M5, M6, M8, M10, M12 (L=70 mm); AISI S2

6x38, 3x75 mm; S2; PH0x75, PH2x38 mm; S2;
6x100 mm; CrV 6150; PH2x100 mm; CrV 6150;
180mm; CrV50; 160mm; CrV50; 150mm;
160 mm LONG NOSE; CrV 6150;
180 mm; CrV 50; EXTERNAL STRAIGHT / PROSTE ZEWNETRZNE;
180 mm; CrV 50; INTERNAL STRAIGHT / PROSTE WEWNETRZNE;
180 mm; CrV 50; EXTERNAL BENT / WYGIĘTE ZEWNETRZNE;
180 mm; CrV 50; INTERNAL BENT / WYGIĘTE WEWNETRZNE;
180; CrMo;
1.5, 2, 2.5, 3, 4, 5, 6, 8, 10 mm; CrV 6150

YATO	drawers / szuflady	
YT-55280	3	1

GB Service tool cabinet with tools
 D Serviceschrank mit Werkzeugen
 PL Szafka serwisowa z narzędziami
 RUS Сервисный шкаф с инструментами
 CZ Servisní skříňka s náradím
 H Szervizszekrény szerszámmal

RO Dulap echipat cu scule
 F Servante d'atelier - set d'outils
 I Armadio per utensili
 E Armario para herramientas de servicio
 CN 工具车托盘组套

WHITE
 CARTON BOX
 & COLOR LABEL



165 PCS 13 TRAY WK/LAD	958x766 x465 mm	7x	BALL BEARING ŁOŻYSKA KULKOWE	35kg 35kg
DRAWERS LOCKING BLOKADA SZUFLAD	CENTRAL LOCK CENTRALNY ZAMEK	NON SLIP WORKTOP BLAT ANTYPOŚLIZGOWY	WHEEL Ø 125 KOŁY	BRAKE HAMULEC
3x	UNIVERSAL PERFORMANCE UNIWERSALNA PERFORACJA	DOUBLE WALLS PODWÓJNE ŚCIANY	CORNER BUMPERS NAROŻNE ODBOJNIKI	



13 interchangeable trays with YATO tools
13 wymiennych modułów z narzędziami YATO

DRAWER / SZUFLADA 1

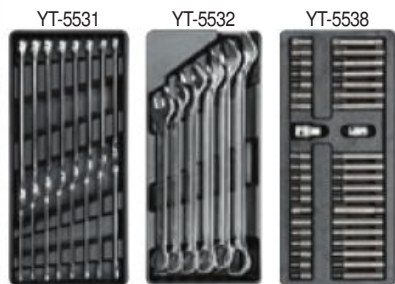

DRAWER / SZUFLADA 2

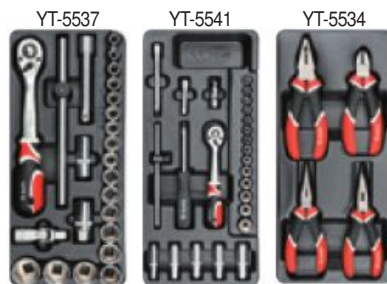

DRAWER / SZUFLADA 3

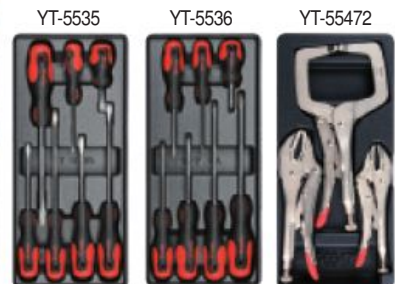

DRAWER / SZUFLADA 4



DRAWER / SZUFLADA 5



DRAWER / SZUFLADA 1

○ □ □ H4, H5, H6, H7, H8, H10, H12 (L=30 mm); H4, H5, H6, H7, H8, H10, H12 (L=75 mm); AISI S2; ○ □ M5, M6, M8, M10, M12 (L=30 mm); M5, M6, M8, M10, M12 (L=75 mm); AISI S2; ○ □ T20, T25, T30, T40, T45, T50, T55 (L=30 mm); T20, T25, T30, T40, T45, T50, T55 (L=75 mm); AISI S2; □ □ 1/2" (12.7 mm), 3/8" (9.5 mm); ○ □ 6, 7, 8, 9, 10, 11, 12, 13, 14, 15, 16, 17, 18, 19, 20, 21 mm; CrV; ○ □ 22, 24, 27, 28, 30, 32 mm; CrV

DRAWER / SZUFLADA 2

□ □ 1/2" (12.7 mm); 10, 11, 12, 13, 14, 15, 16, 17, 18, 19, 20, 21, 22, 23, 24, 27, 30, 32 mm; CrV 50BV30; ○ □ 1/2" (12.7 mm); (255 mm); 72T; CrV 6140; ○ □ 1/2" (12.7 mm); 16; 21 mm; CrV 50BV30; ○ □ 1/2" (12.7 mm); (127 mm); CrV 50BV30; ○ □ 1/2" (12.7 mm); CrV 50BV30; ○ □ 1/4" (6.3 mm); 3.5, 4.0, 4.5, 5.0, 5.5, 6.0, 7.0, 8.0, 9.0, 10.0, 11.0, 12.0, 13.0, 14.0 mm; CrV 50BV30; ○ □ 1/4" (6.3 mm); 8, 10, 11, 12, 13 mm; CrV 50BV30; ○ □ 1/4" (6.3 mm); (50.8, 101.6 mm); CrV 6140; ○ □ 1/4" (6.3 mm); CrV 50BV30; ○ □ 1/4" (6.3 mm); (155 mm); 72T; CrV 6140; ○ □ 1/4" (6.3 mm); (150 mm); CrV 50BV30; ○ □ 180 mm; 1/4" (6.3 mm); (152.4 mm); CrV 50BV30; ○ □ 160 mm; 160 mm LONG NOSE; ○ □ 160 mm BENT NOSE

DRAWER / SZUFLADA 3

○ □ 3x75, 5x100, 5x150, 6x38, 6x100, 6x150, 8x150 mm; CrMo; ○ □ PH0x100, PH1x75, PH1x100, PH2x38, PH2x100, PH2x150, PH3x150 mm; CrMo; ○ □ 180, 250 mm; ○ □ 280 mm

DRAWER / SZUFLADA 4

○ □ 3/4" (19.0 mm); 21, 22, 24, 27, 28, 29, 30, 32, 34, 36, 41, 46, 50, 55 mm; CrV 50BV30; ○ □ 3/4" (19.0 mm); (200 mm); CrV 6140; ○ □ 3/4" (19.0 mm); CrV 50BV30; ○ □ 3/4" (19.0 mm); (500 mm); 72T; CrV 6140; ○ □ 3/4" (19.0 mm); (500 mm); CrV 50BV30

DRAWER / SZUFLADA 5

○ □ □ 1/2" (12.7 mm) x 5/16" (7.9 mm); ○ □ PH3 (L=35 mm); PH1, PH2, PH3 (L=75 mm); ○ □ 8 mm (L=35 mm); 8 mm (L=75 mm); ○ □ 12-38 mm; ○ □ 3" (75 mm); ○ □ 82 mm; ○ □ 200 mm; ○ □ 135 mm; ○ □ 300, 400, 500 mm

YATO	drawers / szuflady	
YT-55293	7	1

GB Service tool cabinet with tools
D Serviceschrank mit Werkzeugen
PL Szafka serwisowa z narzędziami
RUS Сервисный шкаф с инструментами
CZ Servisní skříňka s nářadím
H Szervizszekrény szerszámmal

RO Dulap echipat cu scule
F Servante d'atelier - set d'outils
I Armadio per utensili
E Armario para herramientas de servicio
CN 工具车托盘组套

WHITE
CARTON BOX
& COLOR LABEL



177 PCS
12 TRAY WKŁAD

958x766
x465 mm

6x

BALL BEARING
ŁOŻYSKA KULKOWE

DRAWERS LOCKING
BLOKADA SZUFLAD

NON SLIP
POLYPROPYLENE
WORKTOP
ANTIPOŚLIZGOWY
POLIPROPYLENOWY
BLAT

UNIVERSAL PERFORATION
UNIWERSALNA PERFORACJA

DOUBLE WALLS
PODWÓJNE ŚCIANY

2x1

CORNER BUMPERS
NARÓŻNE ODBOJNIKI



12 interchangeable trays with YATO tools
12 wymiennych modułów z narzędziami YATO

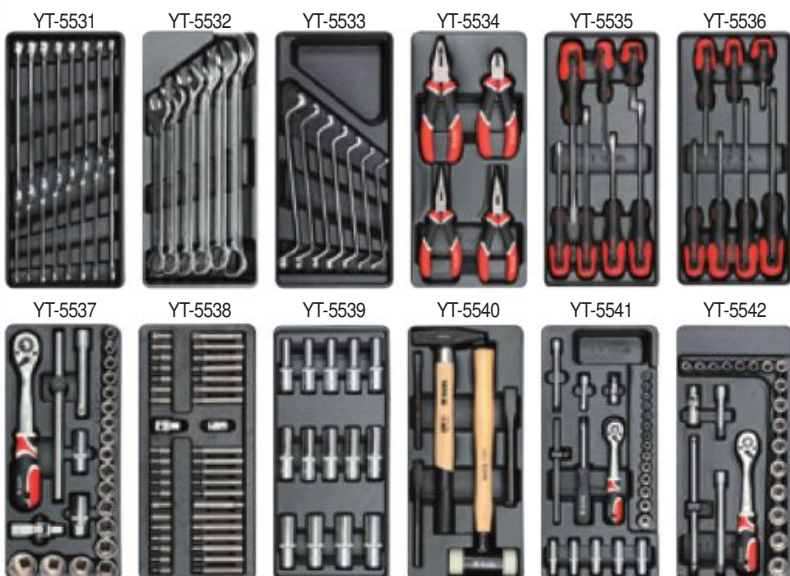

DRAWER / SZUFLADA 1

22, 24, 27, 28, 30, 32 mm; CrV; 6, 7, 8, 9, 10, 11, 12, 13, 14, 15, 16, 17, 18, 19, 20, 21 mm; CrV; 10x11, 12x13, 14x15, 16x17, 18x19 mm; CrV

DRAWER / SZUFLADA 2

3x75, 5x100, 5x150, 6x38, 6x100, 6x150, 8x150 mm; CrMo; PH0x100, PH1x75, PH1x100, PH2x38, PH2x100, PH2x150, PH3x150 mm; CrMo; 180 mm; 160 mm; 160 mm LONG NOSE; 160 mm BENT NOSE

DRAWER / SZUFLADA 3

1/2" (12.7 mm): 10, 11, 12, 13, 14, 15, 16, 17, 18, 19, 20, 21, 22, 23, 24, 27, 30, 32 mm; CrV 50BV30; 1/2" (12.7 mm): (127 mm); CrV 50BV30; 1/2" (12.7 mm); CrV 50BV30; 1/2" (12.7 mm); (255 mm); 72T; CrV 6140; 1/2" (12.7 mm); (255 mm); CrV 50BV30; 1/2" (12.7 mm): 16; 21 mm; CrV 50BV30; H4, H5, H6, H7, H8, H10, H12 (L=30 mm); H4, H5, H6, H7, H8, H10, H12 (L=75 mm); AISI S2; M5, M6, M8, M10, M12 (L=30 mm); M5, M6, M8, M10, M12 (L=75 mm); AISI S2; T20, T25, T30, T40, T45, T50, T55 (L=30 mm); T20, T25, T30, T40, T45, T50, T55 (L=75 mm); AISI S2; 1/2" (12.7 mm), 3/8" (9.5 mm); 1/2" (12.7 mm): 8, 9, 10, 11, 12, 13, 14, 15, 16, 17, 18, 19, 20, 21 mm (L=76 mm); CrV 50BV30

DRAWER / SZUFLADA 4

300 g (L=300 mm); 40 mm (L=350 mm); 10x8x142 mm, 12x10x152 mm, 16x13x172 mm; 3/8" (9.5 mm): 6, 7, 8, 9, 10, 11, 12, 13, 14, 15, 16, 17, 18, 19, 20, 21, 22 mm; CrV 50BV30; 3/8" (9.5 mm); (76, 152.4 mm); CrV 50BV30; 3/8" (9.5 mm); CrV 50BV30; 3/8" (9.5 mm); (200 mm); 72T; CrV 6140; 3/8" (9.5 mm); (198 mm); CrV 50BV30; 1/4" (6.3 mm): 3.5, 4, 4.5, 5, 5.5, 6, 7, 8, 9, 10, 11, 12, 13, 14 mm; CrV 50BV30; 1/4" (6.3 mm): 8, 10, 11, 12, 13 mm; CrV 50BV30; 1/4" (6.3 mm); (50.8, 101.6 mm); CrV 6140; 1/4" (6.3 mm); CrV 50BV30; 1/4" (6.3 mm); (155 mm); 72T; CrV 6140; 1/4" (6.3 mm); (150 mm); CrV 50BV30; 1/4" (6.3 mm); (152.4 mm); CrV 50BV30

YATO	drawers / szuflady	
YT-5530	6	1

GB Service tool cabinet with tools
 D Serviceschrank mit Werkzeugen
 PL Szafka serwisowa z narzędziami
 RUS Сервисный шкаф с инструментами
 CZ Servisní skříňka s náradím
 H Szervizszekrény szerszámmal

RO Dulap echipat cu scule
 F Servante d'atelier - set d'outils
 I Armadio per utensili
 E Armario para herramientas de servicio
 CN 工具车托盘组套

WHITE
 CARTON BOX
 & COLOR LABEL



177 PCS 12 TRAY WKŁAD	975x765 x465 mm	6x BALL BEARING ŁOŻYSKA KULKOWE	25kg 35kg
DRAWERS LOCKING BLOKADA SZUFLAD	NON SLIP POLYPROPYLENE WORKTOP ANTIPOŚLIZGOWY POLIPROPYLENOWY BLAT	125 mm Ø	2x BRAKE HAMULCE
UNIVERSAL PERFORATION UNIWEERSALNA PERFORACJA	DOUBLE WALLS PODWÓJNE ŚCIANY	2x CORNER BUMPERS NARÓŻNE ODBOJNIKI	



12 interchangeable trays with YATO tools
12 wymiennych modułów z narzędziami YATO

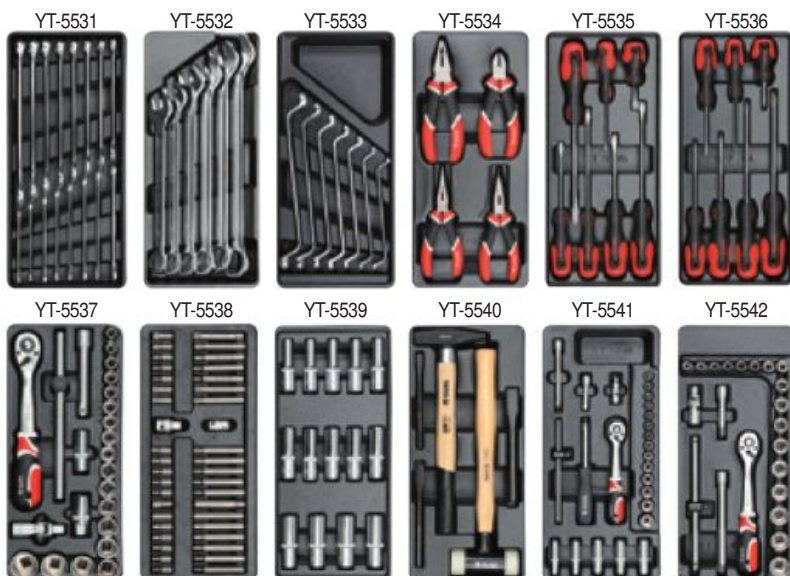

DRAWER / SZUFLADA 1

22, 24, 27, 28, 30, 32 mm; CrV; 6, 7, 8, 9, 10, 11, 12, 13, 14, 15, 16, 17, 18, 19, 20, 21 mm; CrV; 6x7, 8x9, 10x11, 12x13, 14x15, 16x17, 18x19 mm; CrV

DRAWER / SZUFLADA 2

3x75, 5x100, 5x150, 6x38, 6x100, 6x150, 8x150 mm; CrMo; PH0x100, PH1x75, PH1x100, PH2x38, PH2x100, PH2x150, PH3x150 mm; CrMo; 180 mm; 160 mm; 160 mm LONG NOSE; 160 mm BENT NOSE

DRAWER / SZUFLADA 3

1/2" (12.7 mm); 10, 11, 12, 13, 14, 15, 16, 17, 18, 19, 20, 21, 22, 23, 24, 27, 30, 32 mm; CrV 50BV30; 1/2" (12.7 mm); 1/2" (12.7 mm); CrV 50BV30; 1/2" (12.7 mm); 255 mm; 72T; CrV 6140; 1/2" (12.7 mm); 255 mm; CrV 50BV30; 1/2" (12.7 mm); 16; 21 mm; CrV 50BV30; H4, H5, H6, H7, H8, H10, H12 (L=30 mm); H4, H5, H6, H7, H8, H10, H12 (L=75 mm); AISI S2; M5, M6, M8, M10, M12 (L=30 mm); M5, M6, M8, M10, M12 (L=75 mm); AISI S2; T20, T25, T30, T40, T45, T50, T55 (L=30 mm); T20, T25, T30, T40, T45, T50, T55 (L=75 mm); AISI S2; 1/2" (12.7 mm); 3/8" (9.5 mm); 1/2" (12.7 mm); 8, 9, 10, 11, 12, 13, 14, 15, 16, 17, 18, 19, 20, 21 mm (L=76 mm); CrV 50BV30

DRAWER / SZUFLADA 4

300 g (L=300 mm); 40 mm (L=350 mm); 10x8x142 mm; 12x10x152 mm; 16x13x172 mm; 3/8" (9.5 mm); 6, 7, 8, 9, 10, 11, 12, 13, 14, 15, 16, 17, 18, 19, 20, 21, 22 mm; CrV 50BV30; 3/8" (9.5 mm); 76, 152.4 mm; CrV 50BV30; 3/8" (9.5 mm); CrV 50BV30; 3/8" (9.5 mm); 200 mm; 72T; CrV 6140; 3/8" (9.5 mm); 198 mm; CrV 50BV30; 1/4" (6.3 mm); 3.5, 4, 4.5, 5, 5.5, 6, 7, 8, 9, 10, 11, 12, 13, 14 mm; CrV 50BV30; 1/4" (6.3 mm); 8, 10, 11, 12, 13 mm; CrV 50BV30; 1/4" (6.3 mm); 50.8, 101.6 mm; CrV 6140; 1/4" (6.3 mm); CrV 50BV30; 1/4" (6.3 mm); 155 mm; 72T; CrV 6140; 1/4" (6.3 mm); 150 mm; CrV 50BV30; 1/4" (6.3 mm); 152.4 mm; CrV 50BV30

YATO drawers / szuflady	
YT-55300	6 1

GB Service tool cabinet with tools
D Serviceschrank mit Werkzeugen
PL Szafka serwisowa z narzędziami
RUS Сервисный шкаф с инструментами
CZ Servisní skříňka s nářadím
H Szervizszekrény szerszámmal

RO Dulap echipat cu scule
F Servante d'atelier - set d'outils
I Armadio per utensili
E Armario para herramientas de servicio
CN 工具车托盘组套

WHITE
CARTON BOX
& COLOR LABEL



185 PCS 12 TRAYS WKLADOW	970x770 x470 mm	6x	BALL BEARING ŁOŻYSKA KULKOWE	25kg 25kg 35kg
DRAWERS LOCKING BLOKADA SZUFLAD	NON SLIP POLYPROPYLENE WORKTOP ANTIPOŚLIZGOWY POLIPROPYLENOWY BLAT	WHEELS 125 mm	BRAKE HAMULEC	
UNIVERSAL PERFORATION UNIERSALNA PERFORACJA	DOUBLE WALLS PODWÓJNE SCIANY	2x1	CORNER BUMPERS NARÓZNE ODBOJNIKI	



12 interchangeable trays with YATO tools
12 wymiennych modułów z narzędziami YATO

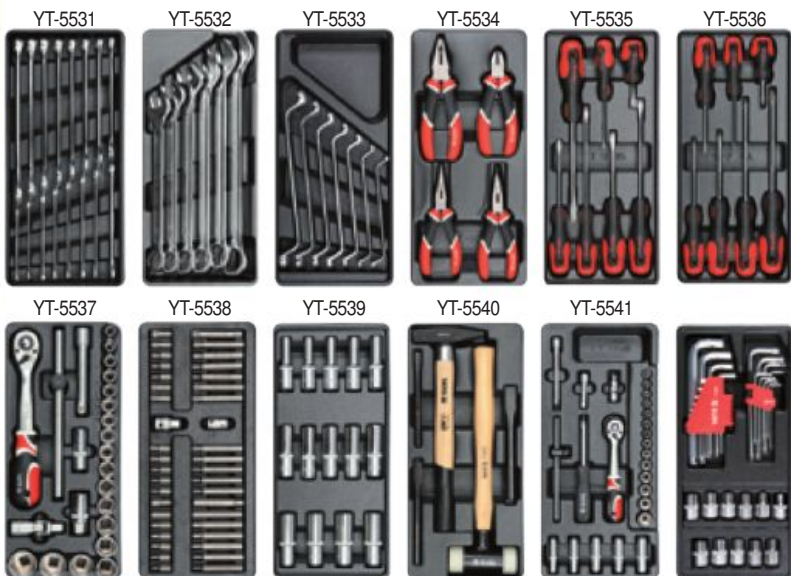

DRAWER / SZUFLADA 1

22, 24, 27, 28, 30, 32 mm; CrV; 6, 7, 8, 9, 10, 11, 12, 13, 14, 15, 16, 17, 18, 19, 20, 21 mm; CrV; 6x7, 8x9, 10x11, 12x13, 14x15, 16x17, 18x19 mm; CrV

DRAWER / SZUFLADA 2

3x75, 5x100, 5x150, 6x38, 6x100, 6x150, 8x150 mm; CrMo; PH0x100, PH1x75, PH1x100, PH2x38, PH2x100, PH2x150, PH3x150 mm; CrMo; 180 mm; 160 mm; 160 mm LONG NOSE; 160 mm BENT NOSE

DRAWER / SZUFLADA 3

1/2" (12.7 mm): 10, 11, 12, 13, 14, 15, 16, 17, 18, 19, 20, 21, 22, 23, 24, 27, 30, 32 mm; CrV 50BV30; 1/2" (12.7 mm); (127 mm); CrV 50BV30; 1/2" (12.7 mm); CrV 50BV30; 1/2" (12.7 mm); (255 mm); Z2T; CrV 6140; 1/2" (12.7 mm); CrV 50BV30; 1/2" (12.7 mm); 16; 21 mm; CrV 50BV30; H4, H5, H6, H7, H8, H10, H12 (L=30 mm); H4, H5, H6, H7, H8, H10, H12 (L=75 mm); AISI S2; M5, M6, M8, M10, M12 (L=30 mm); M5, M6, M8, M10, M12 (L=75 mm); AISI S2; T20, T25, T30, T40, T45, T50, T55 (L=30 mm); T20, T25, T30, T40, T45, T50, T55 (L=75 mm); AISI S2; 1/2" (12.7 mm), 3/8" (9.5 mm); 1/2" (12.7 mm): 8, 9, 10, 11, 12, 13, 14, 15, 16, 17, 18, 19, 20, 21 mm (L=76 mm); CrV 50BV30

DRAWER / SZUFLADA 4

300 g (L=300 mm); 40 mm (L=350 mm); 10x8x142 mm, 12x10x152 mm, 16x13x170 mm; 1/4" (6.3 mm): 3.5, 4, 4.5, 5, 5.5, 6, 7, 8, 9, 10, 11, 12, 13, 14 mm; CrV 50BV30; 1/4" (6.3 mm): 8, 10, 11, 12, 13 mm; CrV 50BV30; 1/4" (6.3 mm): (50.8, 101.6 mm); CrV 6140; 1/4" (6.3 mm); CrV 50BV30; 1/4" (6.3 mm); (155 mm); Z2T; CrV 6140; 1/4" (6.3 mm); (150 mm); CrV 50BV30; 1/4" (6.3 mm); (152.4 mm); CrV 50BV30; 1/2" (12.5 mm): E10, E12, E14, E16, E18, E20; 1/4" (6.3 mm): E4, E5, E6, E7, E8; 2, 2.5, 3, 4, 5, 6, 7, 8, 10, 12 mm; T10, T15, T20, T25, T27, T30, T40, T45, T50

YATO	drawers / szuflady	
YT-55307	6	1

GB Service tool cabinet with tools
 D Serviceschrank mit Werkzeugen
 PL Szafka serwisowa z narzędziami
 RUS Сервисный шкаф с инструментами
 CZ Servisní skříňka s nářadím
 H Szervizszekrény szerszámmal

RO Dulap echipat cu scule
 F Servante d'atelier - set d'outils
 I Armadio per utensili
 E Armario para herramientas de servicio
 CN 工具车托盘组套

WHITE
 CARTON BOX
 & COLOR LABEL



211 PCS 5 TRAY WKŁAD	980x770 x465 mm	7x	BALL BEARING ŁOŻYSKA KULKOWE	30kg / 35kg
DRAWERS LOCKING BLOKADA SZUFLAD	NON SLIP POLYPROPYLENE WORKTOP ANTIPOŚLIŚCZOWY POLIPROPYLENOWY BLAT	WHEELS 125 mm	BRAKE HAMULEC	
3x	UNIVERSAL PERFORMANCE UNIERSALNA PERFORACJA	DOUBLE WALLS PODWÓJNE ŚCIANY	CORNER BUMPERS NARÓŻNE ODBOJNIKI	



DRAWER / SZUFLADA 1

1/2" (12.7 mm): 8, 9, 10, 11, 12, 13, 14, 15, 16, 17, 18, 19, 20, 21, 22, 24 (L=38 mm); 27, 30, 32 mm (L=42 mm); 1/4" (6.3 mm): 4, 4.5, 5, 5.5, 6, 7, 8, 9, 10, 11, 12, 13 (L=25 mm); CrV 50BV30; 1/2" (12.7 mm): 10, 13, 14, 15, 17, 19, 21 mm (L=76 mm); 1/4" (6.3 mm): 6, 7, 8, 9, 10, 11, 12, 13 (L=50 mm); CrV 50BV30; 1/2" (12.7 mm): E10, E11, E12, E14, E16, 1/4" (6.3 mm): E4, E5, E6, E7, E8; CrV 50BV30; 1/2" (12.7 mm): (127, 254 mm); 1/4" (6.3 mm): (50.8, 101.6 mm); CrV 50BV30; 1/2" (12.7 mm): CrV 50BV30; 1/2" (12.7 mm): 16, 21 mm; CrV 50BV30; 1/2" (12.7 mm): (255 mm); 1/4" (6.3 mm): (152.4 mm); CrV 50BV30; 1/2" (12.7 mm): (255 mm); 1/4" (6.3 mm): (155 mm); CrV 6140; 1/4" (6.3 mm): (150 mm); CrV 50BV30; 1/4" (6.3 mm): 4, 5.5, 6.5 mm; AISI S2 / CrV 6150; 1/4" (6.3 mm): PH1 (x2), PH2 (x2), PH3; AISI S2 / CrV 6150; 1/4" (6.3 mm): PZ1, PZ2, PZ3; AISI S2 / CrV 6150; 1/4" (6.3 mm): T8, T10, T15, T20, T25, T30, T40; AISI S2 / CrV 6150; 1/4" (6.3 mm): 3, 4, 5, 6, 7, 8 mm; AISI S2 / CrV 6150

DRAWER / SZUFLADA 2

200 mm; CrV; 3-6 mm (L=52 mm), Ø 6-8 (L=58 mm), Ø 8-11 (L=66 mm), Ø 11-14 (L=75 mm), Ø 14-18 (L=80 mm), Ø 18-25 (L=88 mm); 8, 9, 10, 11, 12, 13, 14, 15, 16, 17, 18, 19, 21, 22, 24 mm; CrV; T10, T15, T20, T25, T27, T30, T40, T45, T50; CrV 6150; 2, 2.5, 3, 4, 5, 6, 7, 8, 10, 12 mm; CrV 6150

DRAWER / SZUFLADA 3

6.0x38, 2.0x75, 3.0x75, 4.0x100, 5.0x100, 6.0x100 mm; PH0x100, PH1x100, PH2x38, PH2x150, PH3x150 mm; T7x75, T8x75, T9x75, T10x100, T15x100, T20x100, T25x100, T27x100 mm; S2; 6.0x150 mm; PH2x150 mm; CrV 6150

DRAWER / SZUFLADA 4

180 mm; 160 mm; 200 mm; 250 mm; 400 g; 340 g; 12.5x152, 16.0x172 mm; CrV 6150; 3.0x150, 4.0x150, 5.0x150, 6.0x150, 8.0x150 mm; CrV 6150; 8.0x112 mm; CrV 6150

DRAWER / SZUFLADA 5

M3x0.5 (x3), M4x0.7 (x3), M5x0.8 (x3), M6x1.0 (x3), M7x1.0 (x3), M8x1.25 (x3), M10x1.5 (x3), M12x1.75 (x3); HSS M2; M3, M4x0.7, M5x0.8, M6x1.0, M7x1.0, M8x1.25, M10x1.5, M12x1.75; HSS M2; M7-M9; M3-M12; #2, 200 mm; #2, 200 mm; #2, 200 mm; 300 mm; LED; 3 m x 16 mm; 0-150 mm

YATO	drawers / szuflady	
YT-55290	7	1

DRAWER / SZUFLADA 1

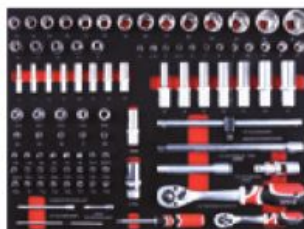

DRAWER / SZUFLADA 2



DRAWER / SZUFLADA 3

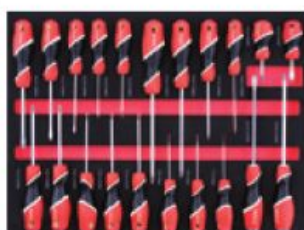

DRAWER / SZUFLADA 4



DRAWER / SZUFLADA 5



CREATE YOUR WORKPLACE - STWÓRZ SWOJĄ MIĘSCĘ PRACY

YT-09061



YT-08921

YT-09152



YT-08922



YT-08920

- GB Tool chest
- D Werkzeugkasten
- PL Szafka warsztatowa
- RUS Портативный ящик для инструментов
- CZ Přenosná skříňka na nářadí
- H Hordozható szerszámós láda
- RO Cabinet pt. scule
- F Servante d'atelier
- I Banco da lavoro armadio
- E Cajonera portátil
- CN 駝檢斬



690x465
x400 mm



NON SLIP
ABS
WORKTOP
ANTYPOŚLIZGOWY
BLAT
Z TWORZYWA ABS



UNIVERSAL
PERFORATION
UNIWERSALNA
PERFORACJA

DRAWERS
LOCKING
BLOKADA
SZUFLAD

CENTRAL
LOCK
CENTRALNY
ZAMEK

2x



DOUBLE
WALLS
PODWÓJNE
SCIĄNY

CORNER BUMPERS
NARÓŻNE ODBOJNIKI



WHITE
CARTON BOX
& COLOR LABEL

YATO	drawers / szuflady	
YT-09152	4	1

- GB Tool chest
- D Werkzeugkasten
- PL Szafka warsztatowa
- RUS Портативный ящик для инструментов
- CZ Přenosná skříňka na nářadí
- H Hordozható szerszámós láda
- RO Cabinet pt. scule
- F Servante d'atelier
- I Banco da lavoro armadio
- E Cajonera portátil
- CN 駝檢斬



690x465
x535 mm



NON SLIP
ABS
WORKTOP
ANTYPOŚLIZGOWY
BLAT
Z TWORZYWA ABS



UNIVERSAL
PERFORATION
UNIWERSALNA
PERFORACJA

DRAWERS
LOCKING
BLOKADA
SZUFLAD

CENTRAL
LOCK
CENTRALNY
ZAMEK

2x



DOUBLE
WALLS
PODWÓJNE
SCIĄNY

CORNER BUMPERS
NARÓŻNE ODBOJNIKI



WHITE
CARTON BOX
& COLOR LABEL

YATO	drawers / szuflady	
YT-09155	6	1

GB Roller cabinet
 D Werkstattrollwagen
 PL Szafka serwisowa
 RUS Инструментальный кабинет
 CZ Dilenská skříňka
 H Szervíz - szekrény
 RO Dulap de scule
 F Servante d'atelier
 I Armadio per utensili
 E Armario en ruedas
 CN 工具车

1000x1130 x570 mm	6+1	BALL BEARING ŁOŻYSKA KULKOWE	UNIVERSAL PERFORATION UNIWERSALNA PERFORACJA
OIL PROOF STEEL WORKTOP OLEJODOPORNY STALOWY BLAT	DRAWERS LOCKING BLOKADA SZUFLAD	DOUBLE WALLS PODWÓJNE SCIĄNY	CORNER BUMPERS NAROŻNE ODBOJNIKI
WHEEL Ø 160 mm	BRAKE HAMULEC	2x	



WHITE
CARTON BOX
& COLOR LABEL

YATO	drawers / szuflady	
YT-09002	6+1	1

GB Roller cabinet
 D Werkstattrollwagen
 PL Szafka serwisowa
 RUS Инструментальный кабинет
 CZ Dilenská skříňka
 H Szervíz - szekrény
 RO Dulap de scule
 F Servante d'atelier
 I Armadio per utensili
 E Armario en ruedas
 CN 工具车

1000x1130 x570 mm	12x	BALL BEARING ŁOŻYSKA KULKOWE	UNIVERSAL PERFORATION UNIWERSALNA PERFORACJA
OIL PROOF STEEL WORKTOP OLEJODOPORNY STALOWY BLAT	DRAWERS LOCKING BLOKADA SZUFLAD	DOUBLE WALLS PODWÓJNE SCIĄNY	CORNER BUMPERS NAROŻNE ODBOJNIKI
WHEEL Ø 160 mm	BRAKE HAMULEC	2x	



WHITE
CARTON BOX
& COLOR LABEL

YATO	drawers / szuflady	
YT-09003	12	1

GB Roller cabinet
 D Werkstattrollwagen
 PL Szafka serwisowa
 RUS Инструментальный кабинет
 CZ Dilenská skříňka
 H Szervíz - szekrény
 RO Dulap de scule
 F Servante d'atelier
 I Armadio per utensili
 E Armario en ruedas
 CN 工具车

995x680 x458mm	6x	DRAWERS LOCKING BLOKADA SZUFLAD	CENTRAL LOCK CENTRALNY ZAMEK	NON SLIP POLYPROPYLENE WORKTOP ANTIPOŚLIZKI POLIPROPYLENOWY BLAT
300 kg max.	BALL BEARING ŁOŻYSKA KULKOWE	WHEEL Ø 127 mm →1" (25.4 mm)	2x BRAKE HAMULCE	2x



WHITE
CARTON BOX
& COLOR LABEL

YATO	drawers / szuflady	
YT-0913	6	1

GB Roller cabinet
 D Werkstattrollwagen
 PL Szafka serwisowa
 RUS Инструментальный кабинет
 CZ Dilenská skříňka
 H Szervíz - szekrény
 RO Dulap de scule
 F Servante d'atelier
 I Armadio per utensili
 E Armario en ruedas
 CN 工具车

995x680 x458mm	7x	DRAWERS LOCKING BLOKADA SZUFLAD	CENTRAL LOCK CENTRALNY ZAMEK	NON SLIP POLYPROPYLENE WORKTOP ANTIPOŚLIZKI POLIPROPYLENOWY BLAT
300 kg max.	BALL BEARING ŁOŻYSKA KULKOWE	WHEEL Ø 127 mm →1" (25.4 mm)	2x BRAKE HAMULCE	2x



WHITE
CARTON BOX
& COLOR LABEL

YATO	drawers / szuflady	
YT-0914	7	1

- GB Roller cabinet
- D Werkstattrollwagen
- PL Szafka serwisowa
- RUS Инструментальный кабинет
- CZ Dílenská skříňka
- H Szerviz - szekrény
- RO Dulap de scule
- F Servante d'atelier
- I Armadio per utensili
- E Armario en ruedas
- CN 工具车



958x766 x465 mm	6x	NON SLIP POLYPROPYLENE WORKTOP ANTYPOŚLIZGOWY POLIPROPYLENOWY BLAT	25kg 35kg 35kg	CORNER BUMPERS NARÓŻNE ODBOJNIKI
DRAWERS LOCKING BLOKADA SZUFLAD	UNIVERSAL PERFORATION UNIERSALNA PERFORACJA	BALL BEARING ŁOŻYSKA KULKOWE	DOUBLE WALLS PODWÓJNE SCIANY	WHEELS 125 mm
				2x BRAKE HAMULCE

WHITE
CARTON BOX
& COLOR LABEL



YATO	drawers / szuflady	
YT-0902	6	1

- GB Roller cabinet
- D Werkstattrollwagen
- PL Szafka serwisowa
- RUS Инструментальный кабинет
- CZ Dílenská skříňka
- H Szerviz - szekrény
- RO Dulap de scule
- F Servante d'atelier
- I Armadio per utensili
- E Armario en ruedas
- CN 工具车



975x765 x465 mm	6x	NON SLIP POLYPROPYLENE WORKTOP ANTYPOŚLIZGOWY POLIPROPYLENOWY BLAT	25kg 35kg 35kg	CORNER BUMPERS NARÓŻNE ODBOJNIKI
2x T	DRAWERS LOCKING BLOKADA SZUFLAD	UNIVERSAL PERFORATION UNIERSALNA PERFORACJA	BALL BEARING ŁOŻYSKA KULKOWE	DOUBLE WALLS PODWÓJNE SCIANY
				WHEELS 125 mm
				2x BRAKE HAMULCE

WHITE
CARTON BOX
& COLOR LABEL



YATO	drawers / szuflady	
YT-55299	6	1

- GB Roller cabinet
- D Werkstattrollwagen
- PL Szafka serwisowa
- RUS Инструментальный кабинет
- CZ Dílenská skříňka
- H Szerviz - szekrény
- RO Dulap de scule
- F Servante d'atelier
- I Armadio per utensili
- E Armario en ruedas
- CN 工具车



932x665 x453 mm	7x	NON SLIP POLYPROPYLENE WORKTOP ANTYPOŚLIZGOWY POLIPROPYLENOWY BLAT	25kg 35kg 35kg	BALL BEARING ŁOŻYSKA KULKOWE
2x T	CENTRAL LOCK CENTRALNY ZAMEK	UNIVERSAL PERFORATION UNIERSALNA PERFORACJA	DOUBLE WALLS PODWÓJNE SCIANY	WHEELS 125 mm
				2x BRAKE HAMULCE

WHITE
CARTON BOX
& COLOR LABEL



YATO	drawers / szuflady	
YT-09000	7	1

- GB Roller cabinet
- D Werkstatttrollwagen
- PL Szafka serwisowa
- RUS Инструментальный кабинет
- CZ Dilenská skříňka
- H Szerviz - szekrény
- RO Dulap de scule
- F Servante d'atelier
- I Armadio per utensili
- E Armario en ruedas
- CN 工具车

995x950 x550 mm	7x	BALL BEARING ŁOŻYSKA KULKOWE	NON SLIP POLYPROPYLENE WORKTOP ANTIPOŚLIZGOWY POLIPROPILENOWY BLAT
DRAWERS LOCKING BLOKFLADA SZUFLAD	CENTRAL LOCK CENTRALNY ZAMEK	WHEELS 127 mm Ø 127 mm → 1" (25.4 mm)	2x BRAKE HAMULCE
UNIVERSAL PERFORATION UNIWERSALNA PERFORACJA			
DOUBLE WALLS PODWÓJNE SCIANY			
CORNER BUMPERS NAROŻNE ODOJNIKI			



WHITE
CARTON BOX
& COLOR LABEL



YATO drawers / szuflady
YT-09008 7 1

- GB Workshop trolley
- D Werkstatt-
Servicewagen
- PL Wózek warsztatowy
- RUS Сервисная тележка
- CZ Dilenský policový vozík
- H Műhelykocsi
- RO Carucior pt. scule
- F Chariot d'atelier
- I Carrello da officina
- E Carro para taller
- CN 3抽屉工具车

795x790 x370 mm	3x TRAY PÓLKA	130 kg (max)
BALL BEARING ŁOŻYSKA KULKOWE	WHEELS 100 mm Ø	2x BRAKE HAMULCE



WHITE
CARTON BOX
& COLOR LABEL



YATO trays / półki
YT-55210 3 1

- GB Shutter cabinet
- D Werkstatt Hängeschrank
- PL Szafka wisząca
- RUS Шкафчик
для инструмента
настенный
- CZ Zavěsná skříňka
- H Szerszámtároló
- RO Raft de scule
- F Placard d'atelier
- I Scaffale
- E Armario colgante
- CN 橙籃掛



1500x605 x185 mm	CENTRAL LOCK CENTRALNY ZAMEK
UNIVERSAL PERFORATION UNIWERSALNA PERFORACJA	

WHITE
CARTON BOX
& COLOR LABEL



YATO size / rozmiar (mm)
YT-09061 1500x605x185 1

16

- GB Workbench
- D Werkbank
- PL Stół warsztatowy
- RUS Верстак
- CZ Pracovní stůl
- H Munkapad
- RO Banc de lucru
- F Table d'atelier
- I Banco da lavoro
- E Banco de trabajo
- CN 工作台



1500x780 x830 mm	NON SLIP ABS WORKTOP ANTIPOŚLIZGOWY BLAT Z TWORZYWA ABS
---------------------	--

WHITE
CARTON BOX
& COLOR LABEL



YATO size / rozmiar (mm)
YT-08920 1500x780x830 1

- GB** Drawer insert / Combination spanners
D Schubladeneinlage / Schrauben- und Ringschlüssel
PL Wkład do szuflady / Klucze płasko-oczkowe
RUS Вклад к выдвижному ящику / Плоско-закрытый накладной ключ
CZ Vložka do zásuvky / Klíče ploché-očkové
H Fiókbetét / Csillag - villás kulcsok
RO Adaos la sertar / Chei plane - inelare
F Module plastique pour servante avec clés mixtes
I Tenone per l'armadio chiavi
E Accesorio de cajón / Llave española de muletilla
CN 两用扳手托盘组套



CrV



6
PCS

22, 24, 27, 28, 30, 32 mm; CrV



- GB** Drawer insert / Bi-hexagonal ring spanner
D Schubladeneinlage / Doppelringschlüssel
PL Wkład do szuflady / Klucze oczkowe odgięte
RUS Вклад к выдвижному ящику / Ключи накладной изогнутый
CZ Vložka do zásuvky / Klíče očkové ohnuté
H Fiókbetét / Hajlítottszárú csillagkulcs
RO Adaos la sertar / Chei inelaro-curbatá
F Module plastique pour servante clés contre-coudées
I Tenone per l'armadio chiavi
E Accesorio de cajón / Llave de estrella
CN 双头高颈梅花扳手托盘组套



CrV



4
PCS

21x23, 24x27, 25x28, 30x32 mm; CrV



16
PCS

6, 7, 8, 9, 10, 11, 12, 13, 14, 15, 16, 17, 18, 19, 20, 21 mm; CrV

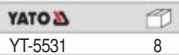

7
PCS

6x7, 8x9, 10x11, 12x13, 14x15, 16x17, 18x19 mm; CrV



- GB** Drawer insert / L-type socket wrench
D Schubladeneinlage / Steckschlüssel gebogen
PL Wkład do szuflady / Klucz nasadowy typ „L”
RUS Вклад к выдвижному ящику / Ключ торцевой L-типа
CZ Vložka do zásuvky / Nástrčný klíč fajfkový
H Fiókbetét / Kulcs, dugó-pipa
RO Adaos la sertar / Cheie tubulara cu cot tip „L”
F Module plastique pour servante / Clé a douille de type „L”
I Tenone per l'armadio / Chiave a tubo tipo „L”
E Accesorio de cajón / Llave de vaso „L”
CN L型套筒扳手托盘组套



CrV



7, 8, 9, 10, 11, 12, 13, 14, 17, 19 mm

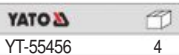

- GB** Drawer insert / Pliers
D Schubladeneinlage / Zangen
PL Wkład do szuflady / Szczypce
RUS Вклад к выдвижному ящику / Клещи
CZ Vložka do zásuvky / Kleště
H Fiókbetét / Fogó készlet
RO Adaos la sertar / Clește
F Module plastique pour servante avec pinces
I Tenone per l'armadio / Pinze
E Accesorio de cajón / Pinzas
CN 钳子托盘组套



4
PCS



180 mm; 160 mm LONG NOSE;
160 mm; 160 mm BENT NOSE



- GB** Drawer insert / Pliers
D Schubladeneinlage / Zangen
PL Wkład do szuflady / Szczypce
RUS Вклад к выдвижному ящику / Клещи
CZ Vložka do zásuvky / Kleště
H Fiókbetét / Zégerfogó készlet
RO Adaos la sertar / Clește
F Module plastique pour servante avec pinces
I Tenone per l'armadio / Pinze
E Accesorio de cajón / Pinzas
CN 挡圈钳托盘组套



4
PCS



180 mm EXTERNAL STRAIGHT; 180 mm INTERNAL STRAIGHT;
180 mm EXTERNAL BENT; 180 mm INTERNAL BENT



GB Drawer insert / Pliers
 D Schubladeneinlage / Zangen
 PL Wkład do szuflady / Szczypce
 RUS Вклад к выдвижному ящику / Клещи
 CZ Vložka do zásuvky / Kleště
 H Fiókbetét / Fogók
 RO Adaos la sertar / Clește
 F Module plastique pour servante avec pinces
 I Tenone per l'armadio / Pinze
 E Accesorio de cajón / Pinzas
 CN 钳子托盘组套

PLASTIC TRAY & COLOR LABEL

3 PCS

CrMo

CrV



180 mm; 250 mm; 250 mm

YATO
 YT-55463 8

GB Drawer insert / Pliers
 D Schubladeneinlage / Zangen
 PL Wkład do szuflady / Szczypce
 RUS Вклад к выдвижному ящику / Клещи
 CZ Vložka do zásuvky / Kleště
 H Fiókbetét / Fogók
 RO Adaos la sertar / Clește
 F Module plastique pour servante avec pinces
 I Tenone per l'armadio / Pinze
 E Accesorio de cajón / Pinzas
 CN 钳子托盘组套

PLASTIC TRAY & COLOR LABEL

3 PCS

CrMo

CrV



180 mm; 250 mm; 280 mm

YATO
 YT-55472 8

GB Drawer insert / Pliers
 D Schubladeneinlage / Zangen
 PL Wkład do szuflady / Szczypce
 RUS Вклад к выдвижному ящику / Клещи
 CZ Vložka do zásuvky / Kleště
 H Fiókbetét / Fogók
 RO Adaos la sertar / Clește
 F Module plastique pour servante avec pinces
 I Tenone per l'armadio / Pinze
 E Accesorio de cajón / Pinzas
 CN 钳子托盘组套

PLASTIC TRAY & COLOR LABEL

3 PCS

CrMo

CrV



250 mm; 125 mm; 300 mm

YATO
 YT-55473 8

GB Drawer insert / Tool set for plumbers
 D Schubladeneinlage / Werkzeug-Set für Klempner
 PL Wkład do szuflady / Zestaw narzędziowy dla hydraulików
 RUS Вклад к выдвижному ящику / Набор инструментов для водопроводчик
 CZ Vložka do zásuvky / Sada nářadí pro instalatér
 H Fiókbetét / Szerszámkészlet vízvezeték-szerelő
 RO Adaos la sertar / Set de instrumente pt. instalator
 F Module plastique pour servante / Un ensemble d'outils pour les plombier
 I Tenone per l'armadio / Tool set per idraulici
 E Accesorio de cajón / Un conjunto de herramientas para fontanero
 CN 水管工具组套

PLASTIC TRAY & COLOR LABEL

4 PCS

CrV

CrMo



250 mm; 330 mm;
 250 mm; 15 m x 19 mm

YATO
 YT-55480 5

GB Drawer insert / Tool set for plumbers
 D Schubladeneinlage / Werkzeug-Set für Klempner
 PL Wkład do szuflady / Zestaw narzędziowy dla hydraulików
 RUS Вклад к выдвижному ящику / Набор инструментов для водопроводчик
 CZ Vložka do zásuvky / Sada nářadí pro instalatér
 H Fiókbetét / Szerszámkészlet vízvezeték-szerelő
 RO Adaos la sertar / Set de instrumente pt. instalator
 F Module plastique pour servante / Un ensemble d'outils pour les plombier
 I Tenone per l'armadio / Tool set per idraulici
 E Accesorio de cajón / Un conjunto de herramientas para fontanero
 CN 水管工具组套

PLASTIC TRAY & COLOR LABEL

5 PCS

CrV

CrMo



250 mm; 250 mm;
 300 mm; 3-32 mm; 10 m x 12 mm

YATO
 YT-55481 5

GB Drawer insert / Tool set for plumbers
 D Schubladeneinlage / Werkzeug-Set für Klempner
 PL Wkład do szuflady / Zestaw narzędziowy dla hydraulików
 RUS Вклад к выдвижному ящику / Набор инструментов для водопроводчик
 CZ Vložka do zásuvky / Sada nářadí pro instalatér
 H Fiókbetét / Szerszámkészlet vízvezeték-szerelő
 RO Adaos la sertar / Set de instrumente pt. instalator
 F Module plastique pour servante / Un ensemble d'outils pour les plombier
 I Tenone per l'armadio / Tool set per idraulici
 E Accesorio de cajón / Un conjunto de herramientas para fontanero
 CN 水管工具组套

PLASTIC TRAY & COLOR LABEL

5 PCS

HSS

8CrB



63 mm;
 6-45 mm; 15 m x 22 mm; 10 m x 12 mm

YATO
 YT-55482 5

- GB Drawer insert / Pliers and adjustable wrenches
D Schubladeneinlage / Zangen und rollgabelschlüssel
PL Wkład do szuflady / Szczypce i klucze nastawne
RUS Вклад к выдвижному ящику / Клещи и ключ разводной
CZ Vložka do zásuvky / Kleště, nastavitelný klíč
H Fiókbetét / Fogók és állítható svédkulcs
RO Adaos la sertar / Clește și cheie reglabilă
F Module plastique pour servante / Pincés et clé a molette
I Tenone per l'armadio / Pinze
E Accesorio de cajón / Pinzas y llave ajustable
CN 活络扳手大力钳托盘组套

PLASTIC TRAY & COLOR LABEL



4
PCS

CrMo



YATO

YT-55444

8

- GB Drawer insert / Pliers
D Schubladeneinlage / Zangen
PL Wkład do szuflady / Szczypce
RUS Вклад к выдвижному ящику / Клещи
CZ Vložka do zásuvky / Kleště
H Fiókbetét / Fogók
RO Adaos la sertar / Clește
F Module plastique pour servante avec pincés
I Tenone per l'armadio / Pinze
E Accesorio de cajón / Pinzas
CN 钳子托盘组套

PLASTIC TRAY & COLOR LABEL



4
PCS

CrV

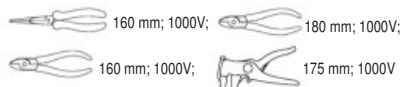

YATO

YT-55464

8

- GB Drawer insert / Slotted screwdrivers
D Schubladeneinlage / Flachschauber
PL Wkład do szuflady / Wkrętaki płaskie
RUS Вклад к выдвижному ящику / Плоские отвертки
CZ Vložka do zásuvky / Šroubováky ploché
H Fiókbetét / Lapos csavarhűzők
RO Adaos la sertar / Șurubelnițe plane
F Module plastique pour servante avec trounevis
I Tenone per l'armadio / Set di cacciaviti piatti
E Accesorio de cajón / Desarmadores planos
CN 一字螺丝批托盘组套

PLASTIC TRAY & COLOR LABEL

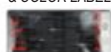

7
PCS

CrMo

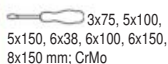
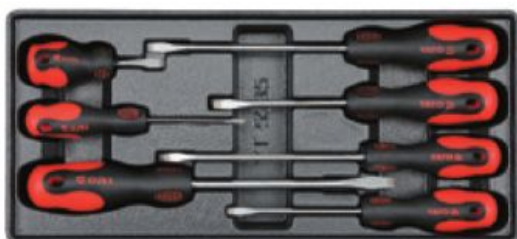

YATO

YT-5535

8

- GB Drawer insert / Phillips screwdrivers
D Schubladeneinlage / Kreuzschlitzschrauber
PL Wkład do szuflady / Wkrętaki krzyżakowe
RUS Вклад к выдвижному ящику / Крестовидные отвертки
CZ Vložka do zásuvky / Šroubováky křížové
H Fiókbetét / Kereszt csavarhűzők
RO Adaos la sertar / Șurubelnițe în cruce
F Module plastique pour servante avec trounevis
I Tenone per l'armadio / Set di cacciaviti a croce
E Accesorio de cajón / Desarmadores de cruz
CN 十字螺丝批托盘组套

PLASTIC TRAY & COLOR LABEL

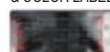

7
PCS

CrMo

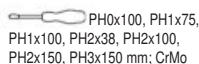

YATO

YT-5536

8

- GB Drawer insert / Screwdriver set
D Schubladeneinlage / Schraubendrehersatz
PL Wkład do szuflady / Komplet wkrętaków
RUS Вклад к выдвижному ящику / Набор отверток
CZ Vložka do zásuvky / Zámečnické šroubováky
H Fiókbetét / Csavarhűző készlet
RO Adaos la sertar / Șurubelniță de lăcătușerie
F Module plastique pour servante avec trounevis
I Tenone per l'armadio / Set di cacciaviti
E Accesorio de cajón / Juego de destornilladores
CN 螺丝批托盘组套

PLASTIC TRAY & COLOR LABEL



13
PCS

S2

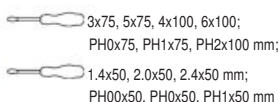

YATO

YT-55455

8

- GB Drawer insert / Go-through screwdrivers
D Schubladeneinlage / Schlagschrauber
PL Wkład do szuflady / Wkrętaki do pobijania
RUS Вклад к выдвижному ящику / Отвертка-било
CZ Vložka do zásuvky / Šroubovák s úderným koncem
H Fiókbetét / Úthető csavarhűző
RO Adaos la sertar / Șurubelniță pt. fixare
F Module plastique pour servante / Allez - par tournevis
I Tenone per l'armadio / Set di cacciaviti
E Accesorio de cajón / Destornillador para dar golpes
CN 穿心螺丝批托盘组套

PLASTIC TRAY & COLOR LABEL



4
PCS

CrV



YATO

YT-55469

8

GB Drawer insert / Screwdriver set
D Schubladeneinlage / Schraubendrehersatz
PL Wkład do szuflady / Komplet wkrętek
RUS Вклад к выдвижному ящику / Набор отвёрток
CZ Vložka do zásuvky / Zámečnické šroubováky
H Fiókbetét / Szigetelt csavarhúzó
RO Adaos la sertar / Șurubelnițe de lăcătușerie
F Module plastique pour servante avec trounevis
I Tenone per l'armadio / Set di cacciaviti
E Accesorio de cajón / Juego de destornilladores
CN 绝缘螺丝批托盘组套

PLASTIC TRAY & COLOR LABEL



8
PCS

S2



3x75, 4x100, 5.5x125, 6.5x150, PH1x80, PH2x100, PH3x150 mm; 1000V;
 4x190 mm; 250V

YATO



YT-55462 8

GB Drawer insert / Tool set
D Schubladeneinlage / Sechskant-Steckschlüssel-Satz
PL Wkład do szuflady / Zestaw narzędziowy
RUS Вклад к выдвижному ящику / Набор инструмента
CZ Vložka do zásuvky / Sada nástrčných klíčů a ráčny
H Fiókbetét / Dugókulcs készlet racsnis hajtókarral
RO Adaos la sertar / Rotrușa chei tubulare cu antrenor
F Module plastique pour servante / Coffret d'outillage
I Tenone per l'armadio / Set di utensilii
E Accesorio de cajón / Juego de herramientas
CN 套筒扳手组套

PLASTIC TRAY & COLOR LABEL



4
PCS

CrV



3/4" (19.0 mm); (200 mm); CrV 6140;
 3/4" (19.0 mm); CrV 50BV30;
 3/4" (19.0 mm); (500 mm); 72T; CrV 6140;
 3/4" (19.0 mm); (500 mm); CrV 50BV30

YATO



YT-55458 4

GB Drawer insert / Socket set
D Schubladeneinlage / Steckschlüsselsatz
PL Wkład do szuflady / Zestaw kluczy nasadowych
RUS Вклад к выдвижному ящику / Торцовые ключи
CZ Vložka do zásuvky / Klíče nástrčné
H Fiókbetét / Dugókulcsok
RO Adaos la sertar / Duză cheie
F Module plastique pour servante avec set d'outillages
I Tenone per l'armadio chiave a bussola
E Accesorio de cajón / Llaves de cubo
CN 套筒托盘组套

PLASTIC TRAY & COLOR LABEL



22
PCS



3/8" (9.5 mm); 6, 7, 8, 9, 10, 11, 12, 13, 14, 15, 16, 17, 18, 19, 20, 21, 22 mm; CrV 50BV30;
 3/8" (9.5 mm); (76, 152.4 mm); CrV 50BV30;
 3/8" (9.5 mm); CrV 50BV30;
 3/8" (9.5 mm); (200 mm); 72T; CrV 6140;
 3/8" (9.5 mm); (198 mm); CrV 50BV30

YATO



YT-5542 8

GB Drawer insert / Socket set
D Schubladeneinlage / Steckschlüsselsatz
PL Wkład do szuflady / Zestaw kluczy nasadowych
RUS Вклад к выдвижному ящику / Торцовые ключи
CZ Vložka do zásuvky / Klíče nástrčné
H Fiókbetét / Dugókulcsok
RO Adaos la sertar / Duză cheie
F Module plastique pour servante avec set d'outillages
I Tenone per l'armadio chiave a bussola
E Accesorio de cajón / Llaves de cubo
CN 套筒托盘组套

PLASTIC TRAY & COLOR LABEL



25
PCS



1/4" (6.3 mm); 3.5, 4, 4.5, 5, 5.5, 6, 7, 8, 9, 10, 11, 12, 13, 14 mm; CrV 50BV30;
 1/4" (6.3 mm); 8, 10, 11, 12, 13 mm; CrV 50BV30;
 1/4" (6.3 mm); (50.8, 101.6 mm); CrV 6140;
 1/4" (6.3 mm); CrV 50BV30;
 1/4" (6.3 mm); (155 mm); 72T; CrV 6140;
 1/4" (6.3 mm); (150 mm); CrV 50BV30;
 1/4" (6.3 mm); (152.4 mm); CrV 50BV30

YATO



YT-5541 8

GB Drawer insert / Socket set
D Schubladeneinlage / Steckschlüsselsatz
PL Wkład do szuflady / Zestaw kluczy nasadowych
RUS Вклад к выдвижному ящику / Торцовые ключи
CZ Vložka do zásuvky / Klíče nástrčné
H Fiókbetét / Dugókulcsok
RO Adaos la sertar / Duză cheie
F Module plastique pour servante avec set d'outillages
I Tenone per l'armadio chiave a bussola
E Accesorio de cajón / Llaves de cubo
CN 套筒托盘组套

PLASTIC TRAY & COLOR LABEL



24
PCS



1/2" (12.7 mm); 10, 11, 12, 13, 14, 15, 16, 17, 18, 19, 20, 21, 22, 23, 24, 27, 30, 32 mm; CrV 50BV30;
 1/2" (12.7 mm); (127 mm); CrV 50BV30;
 1/2" (12.7 mm); CrV 50BV30;
 1/2" (12.7 mm); (255 mm); 72T; CrV 6140;
 1/2" (12.7 mm); (255 mm); CrV 50BV30;
 1/2" (12.7 mm); 16; 21 mm; CrV 50BV30

YATO



YT-5537 4

GB Drawer insert / Screwdriver bits
D Schubladeneinlage / Endstücke für Schraubenzieher
PL Wkład do szuflady / Końcówki śrubokrętowe
RUS Вклад к выдвижному ящику / Насадки для отвёрток
CZ Vložka do zásuvky / Šroubovací nástavce
H Fiókbetét / Csavarhúzó bitek
RO Adaos la sertar / Terminații pt. șurubelnițe
F Module plastique pour servante avec set d'embouts
I Tenone per l'armadio chiave punti di avvitamento
E Accesorio de cajón / Puntas para desarmadores
CN 旋具头托盘组套

PLASTIC TRAY & COLOR LABEL



40
PCS



H4, H5, H6, H7, H8, H10, H12 (L=30 mm); H4, H5, H6, H7, H8, H10, H12 (L=75 mm); AISI S2; M5, M6, M8, M10, M12 (L=30 mm); M5, M6, M8, M10, M12 (L=75 mm); AISI S2; T20, T25, T30, T40, T45, T50, T55 (L=30 mm); T20, T25, T30, T40, T45, T50, T55 (L=75 mm); AISI S2; 1/2" (12.7 mm), 3/8" (9.5 mm)

YATO



YT-5538 8

- GB** Drawer insert / Socket set
D Schubladeneinlage / Steckschlüsselsatz
PL Wkład do szuflady / Zestaw kluczy nasadowych
RUS Вклад к выдвижному ящику / Торцовые ключи
CZ Vložka do zásuvky / Klíče nástrčné
H Fiókbetét / Dugókulcs készlet
RO Adaos la sertar / Duza cheie
F Module plastique pour servante avec set d'outillages
I Tenone per l'armadio chiave a bussola
E Accesorio de cajón / Llaves de cubo
CN 套筒托盘组套



3/4" (19.0 mm): 19, 21, 22, 24, 27, 28, 30, 32, 34, 36, 41, 46, 50, 55 mm



- GB** Drawer insert / Deep sockets
D Schubladeneinlage / Tiefe Steckschlüssel
PL Wkład do szuflady / Klucze nasadowe długie
RUS Вклад к выдвижному ящику / Торцовые глубокие ключи
CZ Vložka do zásuvky / Klíče nástrčné hluboké
H Fiókbetét / Hosszú dugókulcsok
RO Adaos la sertar / Prize de curent adânci
F Module plastique pour servante avec set de douilles
I Tenone per l'armadio chiave a bussola lunghe
E Accesorio de cajón / Llaves de cubo profundo
CN 六角长套筒托盘组套



1/2" (12.7 mm): 8, 9, 10, 11, 12, 13, 14, 15, 16, 17, 18, 19, 20, 21 mm (L=76 mm); CrV 50BV30



- GB** Drawer insert / Tool set
D Schubladeneinlage / Sechskant-Steckschlüssel-Satz
PL Wkład do szuflady / Zestaw narzędziowy
RUS Вклад к выдвижному ящику / Набор инструмента
CZ Vložka do zásuvky / Sada nástrčných klíčů a ráčny
H Fiókbetét / Dugókulcs készlet
RO Adaos la sertar / Rotrusa chei tubulare cu antrenor
F Module plastique pour servante / Coffret d'outilage
I Tenone per l'armadio / Set di utensili
E Accesorio de cajón / Juego de herramientas
CN 套筒扳手组套



1/2" (12.7 mm): E10, E12, E14, E16, E18, E20 (L=38 mm); CrV 50BV30;
M5, M6, M8, M10, M12 (L=30 mm); AISI S2;
1/2" (12.7 mm): 10 mm; CrV 6150;
2, 2.5, 3, 4, 5, 6, 7, 8, 10, 12 mm; CrV 6150;
T10, T15, T20, T25, T27, T30, T40, T45, T50; CrV 6150



- GB** Drawer insert / Hammers and chisels
D Schubladeneinlage / Hämmer und Meißel
PL Wkład do szuflady / Młotki i przecinaki
RUS Вклад к выдвижному ящику / Молотки и зубила
CZ Vložka do zásuvky / Kladiva, dláta a sekáče
H Fiókbetét / Kalapácsok és hidegvágók
RO Adaos la sertar / Ciocane și dălji
F Module plastique pour servante avec marteaux et burins
I Tenone per l'armadio martelli e scalpelli
E Accesorio de cajón / Martillos y cinceles
CN 锤头凿子托盘组套



300 g (L=300 mm);
40 mm (L=350 mm);
10x8x142 mm,
12x10x152 mm, 16x13x172 mm



- GB** Drawer insert / Measuring tools
D Schubladeneinlage / Messwerkzeuge
PL Wkład do szuflady / Narzędzia miernicze
RUS Вклад к выдвижному ящику / Измерительные приборы
CZ Vložka do zásuvky / Měření
H Fiókbetét / Mérőeszközök
RO Adaos la sertar / Instrumente de măsură
F Module plastique pour servante / Outils de mesurage
I Tenone per l'armadio / Strumenti di misura
E Accesorio de cajón / Instrumentos de medición
CN 量具托盘组套



300 mm; 0-150 mm;
2 m;
3m x 16 mm; 0.02-1.00 mm



- GB** Drawer insert / Steel file set
D Schubladeneinlage / Werkstatt-feilen
PL Wkład do szuflady / Pilniki do metalu
RUS Вклад к выдвижному ящику / Набор напильников слесарных
CZ Vložka do zásuvky / Zámeňické pilníky
H Fiókbetét / Lakatos reszelő
RO Adaos la sertar / Pile de lăcătușerie
F Module plastique pour servante / Fichier steel ensemble
I Tenone per l'armadio / File di metallo
E Accesorio de cajón / Juego de limas para metal
CN 锉刀托盘组套



#2 = 200 mm;
#2 = 200 mm;
#2 = 200 mm;
#2 = 200 mm;
#2 = 200 mm





GB Drawer insert / Hand riveter with rivets
D Schubladeneinlage / Blindnietzange
PL Wkład do szuflady / Nitownica ręczna z głowicą obrotową
RUS Вклад к выдвижному ящику / Заклепочник
CZ Vložka do zásuvky / Ruční nýtovačka
H Fiókbetét / Kézi popzegecshezűzű
RO Adaos la sertar / Pcleşte pt. popnituri
F Module plastique pour servante / Riveteuse a main
I Tenone per l'armadio / Rivettatrice manuale girevole
E Accesorio de cajón / Remachadora de mano
CN 手动铆钉枪及铆钉托盘组套

PLASTIC TRAY & COLOR LABEL

6 PCS
CrMo



 2.4, 3.2, 4.0, 4.8 mm;
 9.6x3.2, 9.6x4.0, 12.7x4.0, 9.6x4.8, 12.7x4.8 mm





YATO

 YT-55466 8

GB Drawer insert / Tool set
D Schubladeneinlage / Sechskant-Steckschlüssel-Satz
PL Wkład do szuflady / Zestaw narzędziowy
RUS Вклад к выдвижному ящику / Набор инструмента
CZ Vložka do zásuvky / Sada nástrčných klíčů a ráčny
H Fiókbetét / Dugókulcs készlet racsnis hajtókarral
RO Adaos la sertar / Rotrusa chei tubulare cu antrenor
F Module plastique pour servante / Coffret d'outillage
I Tenone per l'armadio / Set di utensilii
E Accesorio de cajón / Juego de herramientas
CN 套筒扳手套套

PLASTIC TRAY & COLOR LABEL

6 PCS
CrMo
CrV



 1"(25 mm), L=330 mm;
 250 mm;
 2.4, 3.2, 4.0, 4.8 mm;
 9.6x3.2, 9.6x4.0, 12.7x4.8 mm

YATO



 YT-55478 8

GB Drawer insert / Automotive workshop tools
D Schubladeneinlage / Kfz-werkzeuge
PL Wkład do szuflady / Zestaw narzędzi warsztatowych
RUS Вклад к выдвижному ящику / Автомобильные инструменты
CZ Vložka do zásuvky / Auto nářadí
H Fiókbetét / Autóipari szerszámok
RO Adaos la sertar / Scule auto
F Module plastique pour servante / Outils de réparation automobile
I Tenone per l'armadio / Set attrezzi officina
E Accesorio de cajón / Herramientas de automoción
CN 轮胎修理工具托盘组套

PLASTIC TRAY & COLOR LABEL

5 PCS
CrV



 200 mm;  135 mm;
 300, 400, 500 mm







YATO

 YT-55477 4

GB Drawer insert / Automotive workshop tools
D Schubladeneinlage / Kfz-werkzeuge
PL Wkład do szuflady / Zestaw narzędzi warsztatowych
RUS Вклад к выдвижному ящику / Автомобильные инструменты
CZ Vložka do zásuvky / Auto nářadí
H Fiókbetét / Autóipari szerszámok
RO Adaos la sertar / Scule auto
F Module plastique pour servante / Outils de réparation automobile
I Tenone per l'armadio / Set attrezzi officina
E Accesorio de cajón / Herramientas de automoción
CN 轮胎修理工具托盘组套

PLASTIC TRAY & COLOR LABEL

10 PCS
CrV



 1/2" (12.7 mm) x 5/16" (7.9 mm);
 PH3 (L=35 mm); PH1, PH2, PH3 (L=75 mm);
 8 mm (L=35 mm); 8 mm (L=75 mm);
 12-38 mm;  3" (75 mm);  82 mm

YATO





 YT-55476 4

GB Drawer insert / Tool set
D Schubladeneinlage / Sechskant-Steckschlüssel-Satz
PL Wkład do szuflady / Zestaw narzędziowy
RUS Вклад к выдвижному ящику / Набор инструмента
CZ Vložka do zásuvky / Sada nástrčných klíčů a ráčny
H Fiókbetét / Dugókulcs készlet racsnis hajtókarral
RO Adaos la sertar / Rotrusa chei tubulare cu antrenor
F Module plastique pour servante / Coffret d'outillage
I Tenone per l'armadio / Set di utensilii
E Accesorio de cajón / Juego de herramientas
CN 套筒扳手套套

PLASTIC TRAY & COLOR LABEL

23 PCS



 140 mm;  200 mm;
 19 mm x 20 mm;  4x190 mm; 250 V;
 1.0, 1.5, 2.0, 2.5, 3.0, 3.5, 4.0, 4.5, 5.0, 5.5, 6.0, 6.5, 7.0, 7.5, 8.0, 8.5, 9.0, 9.5, 10.0 mm

YATO





 YT-55471 8

GB Drawer insert / Taps and die set
D Schubladeneinlage / Gewindeschneidwerkzeug-satz
PL Wkład do szuflady / Zestaw narzynek i gwintowników
RUS Вклад к выдвижному ящику / Набор плашек и метчиков
CZ Vložka do zásuvky / Souprava závitníků a kruhových závitových čelistů
H Fiókbetét / Menetfűró és menetvágó készlet
RO Adaos la sertar / Set de tarozi și filiere
F Module plastique pour servante / Pince a riveter avec embouts
I Tenone per l'armadio / Set di filiera a maschi
E Accesorio de cajón / Juego de machos de roscar y cojinetes
CN 丝锥板牙托盘组套

PLASTIC TRAY & COLOR LABEL

35 PCS
HCS



 3x: M3x0.5, M4x0.7, M5x0.8, M6x1.0, M7x1.0, M8x1.25, M10x1.5, M12x1.75;  M3x0.5, M4x0.7, M5x0.8, M6x1.0, M7x1.0, M8x1.25, M10x1.5, M12x1.75;  0.5 - 1.75 mm; 27G; 28G;
 M7-M9;  M3-M12

YATO

 YT-55465 8

- GB Drawer insert
D Schubladeneinlage
PL Wkład do szuflady
RUS Вклад к выдвижному ящику
CZ Vložka do zásuvky
H Fiókbetét
- RO Adaos la sertar
F Module plastique pour servante
I Tenone per l'armadio
E Accesorio de cajón
CN 吸塑盒



for / dla: YT-5531

YATO	
YT-55311	5/30



for / dla: YT-5532

YATO	
YT-55321	5/30



for / dla: YT-5533

YATO	
YT-55331	5/30

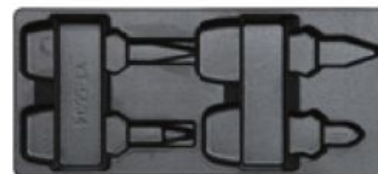

for / dla: YT-5534

YATO	
YT-55341	5/30

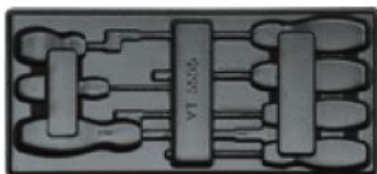

for / dla: YT-5535

YATO	
YT-55351	5/30



for / dla: YT-5536

YATO	
YT-55361	5/30



for / dla: YT-5537

YATO	
YT-55371	5/30



for / dla: YT-5538

YATO	
YT-55381	5/30



for / dla: YT-5539

YATO	
YT-55391	5/30



for / dla: YT-5540

YATO	
YT-55401	5/30



for / dla: YT-5541

YATO	
YT-55411	5/30



for / dla: YT-5542

YATO	
YT-55421	5/30



for / dla: YT-55454

YATO	
YT-55479	5/30

- GB Legs for workbench, long
D Beine für Werkbank, lange
PL Nogi do stołu warsztatowego, długie
RUS Ножки для верстака, длинные
CZ Nohy k pracovnímu stolu, dlouhé
H Lábak munkapadhoz
RO Picioare pt. banc de lucru, lungi
F Jambes pour table d'atelier
I Gambe del tavolo piedi del banco da lavoro
E Patas para banco de trabajo, largas
CN 工作台长桌腿



2
PCS
140
cm

for / dla: YT-08920

YATO	size / rozmiar (cm)	
YT-08921	140	2

WHITE
CARTON BOX
& COLOR LABEL



- GB Holders for workshop box
D Halterungen für die Montage eines Werkstattschranks
PL Uchwyty do montażu szafki warsztatowej
RUS Крепеж для рабочего шкафа
CZ Montážní držáky dílenské skřínky
H Műhelyszekrény tartó
RO Suporturi pt. montarea dulapului de atelier
F Porte-placard d'atelier
I Staffa di montaggio per armadio portautensili
E Elementos de fijación para instalación de cajón de taller
CN 工具柜安装挂板



2
PCS
500x100
x350 mm

for / dla: YT-08920, YT-09152

YATO	size / rozmiar (mm)	
YT-08922	500x100x350	2

WHITE
CARTON BOX
& COLOR LABEL



- GB Connection steel pipes set
 D Anschluss Stahlrohre Gesetzt
 PL Rury montażowe
 RUS Стальная труба монтаж
 CZ Ocelové trubky
 H Acélcsővek
 RO Tevi din oțel
 F Tuyaux en acier
 I Set di montaggio per tabella utensili
 E Tubos de acero
 CN 工具柜连接杆



POLYBAG

2
PCS
48.5
x \varnothing 2.8 cm

for / dla:
 YT-09152
 YT-09155
 +
 YT-0902
 YT-0903
 YT-0904



YATO	size / rozmiar (cm)	
YT-09071	48.5 x \varnothing 2.8	20

- GB Double project center backwall
 D Werkzeugwand
 PL Tablica narzędziowa
 RUS Доска инструмент
 CZ Držáky na nářadí
 H Szerszámartató fal akasztókkal
 RO Suport perete scule
 F Mur d'outil
 I La tabella utensili
 E Panel de herramientas
 CN 工具车双挂板



POLYBAG

2
PCS
65.2 x 61
x 5.5 cm

for / dla:
 YT-0902 YT-55290
 YT-0903 YT-55292
 YT-09031 YT-55293
 YT-0904 YT-5530



YATO	size / rozmiar (cm)	
YT-09072	65.2x61x5.5	2

- GB Compartmented shelf and paper roll holder
 D Werkstattwagenab-lage mit Papierrollehalter
 PL Półka z uchwytem na papier
 RUS Полка с держателем для бумаги
 CZ Police s úchytem na papír
 H Kiegészítő polc és papírrölni tartó funkcióval
 RO Compartiment pt. dulap si suport hartie
 F Support rouleau papier
 I Mensola portarotoli carta
 E Estante con sujetapapel
 CN 托架



for / dla: YT-0902, YT-0903, YT-0904, YT-0905

YATO	size / rozmiar (mm)	
YT-0907	305x305x145	4

- GB Dustbin
 D Abfalleimer
 PL Pojemnik na odpady
 RUS Мусорный ящик
 CZ Zásobník na odpad
 H Szemétkosár
 RO Lada de gunoi
 F Poubelle
 I Contenitore di rifiuti
 E Cubo de basura
 CN 废品箱



for / dla: YT-0902, YT-0903, YT-0904, YT-0905

YATO	size / rozmiar (mm)	
YT-0908	300x300x190	4

- GB Separate board for drawer
 D Trennsteg für Werkstatt-Wagen-Schublade
 PL Przegroda do szafki
 RUS Перегородки для ящика
 CZ Půlhrádka do police
 H Több rekeszes tálcá
 RO Sertar separat de masura mica
 F Cloison tiroir court
 I Separatore per armadio
 E Separador para armario
 CN 抽屉分隔板



for / dla: YT-0902, YT-0903, YT-0904, YT-0905

YATO	size / rozmiar (mm)	
YT-0910	391x58x4	24
YT-0911	391x128x4	24



GB Tool box
D Werkzeugkasten
PL Skrzynka narzędziowa
RUS Инструментальный ящик
CZ Skříňka na nářadí
H Szerszámós láda

RO Cutie de scule
F Boîte à outils
I Cassetta degli attrezzi
E Caja de herramientas
CN 工具箱

WHITE
CARTON BOX
& COLOR LABEL

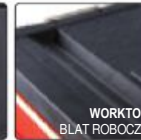

390x215x130 mm
max 10 kg



390x215x60 mm
max 5 kg

390x215x60 mm
max 5 kg

YATO	drawers / szuflady	
YT-09108	1	2

YATO	drawers / szuflady	
YT-09107	2	2

GB Tool trolley
D Werkzeugkasten
PL Wózek narzędziowy 3-częściowy
RUS Тележка инструментальная
CZ Vozík na nářadí
H Szerszám kocsi
RO Troler pt. scule
F Servante d'atelier
I Armadio per utensili
E Herramienta carro
CN 工具箱



WHITE
CARTON BOX
& COLOR LABEL

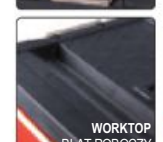

420x220x150 mm
max 20 kg

390x215x130 mm
max 10 kg

410x210x280 mm
max 15 kg

420x220x150 mm
max 20 kg

390x215x60 mm
max 5 kg

390x215x60 mm
max 5 kg

410x210x280 mm
max 15 kg



WORKTOP
BLAT ROBOCZY

MODULES
PROTECTION

ZABEZPIECZENIE
MODUŁÓW

RUBBER CORNER
GUMOWY NAROŻNIK

YATO		
YT-09102	1	1

YATO		
YT-09101	1	1

- | | | |
|-----------------------------|-------------------------------------|-------------------------------|
| GB Tool trolley | RUS Тележка инструментальная | F Servante d'atelier |
| D Werkzeugkasten | инструментальная | I Armadio per utensili |
| PL Wózek narzędziowy | CZ Vozík na nářadí | E Herramienta carro |
| 3-częściowy | H Szerszám kocsi | CN 工具箱 |
| z narzędziami | RO Troler cu scule | |

WHITE CARTON BOX & COLOR LABEL

78 PCS
3 STAGES
WŁADY



- 1/2" (12.7 mm): 8, 10, 12, 13, 14, 15, 16, 17, 18, 19, 20, 21, 22 mm; CrV 50BV30;
- 1/2" (12.7 mm): (127 mm); CRV 50BV30;
- 1/2" (12.7 mm): (255 mm); 72T; CRV 6140;
- 3x75, 6x100; PH0x75, PH2x100 mm; S2; 215 mm;
- 1/4" (6.3 mm): 3.0, 3.5, 4.0, 5.5, 6.5 mm (L=25 mm); S2;
- 1/4" (6.3 mm): PH0, PH1, PH2, PH3 (L=25 mm); S2;
- 1/4" (6.3 mm): PZ0, PZ1, PZ2, PZ3 (L=25 mm); S2;
- 1/4" (6.3 mm): T10, T15 (L=25 mm); S2;
- 1/4" (6.3 mm): 2.0, 3.0, 4.0, 5.0, 6.0 mm (L=25 mm); S2;
- 1/4" (6.3 mm): 5.0, 6.0, 7.0, 8.0(x2), 9.0, 10.0, 11.0, 12.0, 13.0 mm



- 8, 10, 12, 13, 14, 15, 16, 17, 18, 19, 21 mm; CrV
- 18 mm; SK5; 18 mm; SK5; 3 m x 16 mm



- 180 mm; 160 mm; 200 mm; LONG NOSE;
- 300 mm; 16-38 mm; 2, 2.5, 3.0, 4.0, 5.0, 6.0, 7.0, 8.0, 10, 12 mm; CrV 6150



YATO YT-09104 1

- | | |
|--|---|
| GB Hermetic toolbox | RUS Герметический инструмент чемодан |
| D Hermetisch Werkzeugkoffer | инструмент чемодан |
| PL Walizka narzędziowa hermetyczna | инструмент чемодан |
| CZ Kufř na nářadí | инструмент чемодан |
| H Szerszámosláda | инструмент чемодан |
| RO Cutie scule ermetica | инструмент чемодан |
| F Boîte à outils hermétique | инструмент чемодан |
| I Valigetta portautensili a tenuta stagna | инструмент чемодан |
| E Caja de herramientas hermetica | инструмент чемодан |
| CN 安全箱 | инструмент чемодан |



- DECOMPRESSION VALVE INCLUDED
DAMPING ZONE/DECOMPRESSION
- WATER PROOF
ODPORNA NA WODĘ
- SHOCK PROOF
ODPORNA NA WSTRZĄSY
- PP**
- IP55**
- FOAM INSERT
WKŁAD GĄBKOWY



YATO size / rozmiar (mm) 12	YATO size / rozmiar (mm) 8	
YT-08900 232x192x111	YT-08901 270x246x124	



YATO size / rozmiar (mm) 4	YATO size / rozmiar (mm) 2	YATO size / rozmiar (mm) 2
YT-08902 339x295x152	YT-08903 406x330x174	YT-08904 470x357x176



YATO size / rozmiar (mm) 1	YATO size / rozmiar (mm) 2	YATO size / rozmiar (mm) 2
YT-08905 559x351x229	YT-08906 569x425x215	YT-08907 430x244x341

GB Cantilever tool box
D Werkzeugkoffer
PL Skrzynka narzędziowa
RUS Инструментальный ящик

CZ Nástrojová skříňka
H Szerszámosláda
RO Cutie pt. scule
F Boîte à outils

I Cassetta degli attrezzi
E Caja de herramientas
CN 工具箱

WHITE
CARTON
BOX
& COLOR
LABEL



YATO	size / rozmiar (mm)	
YT-0882	360x150x115	4

YATO	size / rozmiar (mm)	
YT-0883	428x180x180	1

YATO	size / rozmiar (mm)	
YT-0884	460x200x180	1



YATO	size / rozmiar (mm)	
YT-0885	460x200x225	1

YATO	size / rozmiar (mm)	
YT-0886	510x220x240	1

GB Cantilever tool box
D Werkzeugkoffer
PL Skrzynka narzędziowa
RUS Инструментальный ящик

CZ Nástrojová skříňka
H Szerszámosláda
RO Cutie pt. scule
F Boîte à outils

I Cassetta degli attrezzi
E Caja de herramientas
CN 工具箱

WHITE
CARTON
BOX
& COLOR
LABEL



2x



3x



4x

YATO	drawers / szuflady	size / rozmiar (mm)	
YT-08872	2	218x255x520	1

YATO	drawers / szuflady	size / rozmiar (mm)	
YT-08873	3	218x300x520	1

YATO	drawers / szuflady	size / rozmiar (mm)	
YT-08874	4	218x360x520	1

GB Tool box with tools
D Werkzeugkoffer
PL Skrzynka z narzędziami
RUS Инструментальный ящик
CZ Nástrojová skříňka
H Szerszámosláda

RO Cutie pt. scule
F Boîte d'outils
I Cassetta degli attrezzi
E Caja de herramientas
CN 工具组套

WHITE
CARTON
BOX
& COLOR
LABEL



62 PCS	1/2" 12.5mm	CrV 50BV30	CrV 6150	CrV 6140	72T	AS-DRIVE	⊖	⊕
-----------	----------------	---------------	-------------	-------------	-----	----------	---	---

- 1/2" (12.7 mm): 10, 11, 12, 13, 14, 15, 16, 17, 18, 19, 20, 21, 22, 23, 24 mm (L=38 mm); 27, 30, 32 mm (L=42 mm); CrV 50BV30;
- 1/2" (12.7 mm): (76, 127, 254 mm); CrV 50BV30;
- 1/2" (12.7 mm); CrV 50BV30;
- 1/2" (12.7 mm): 21 mm; CrV 50BV30;
- 1/2" (12.7 mm); (255 mm); CrV 50BV30;
- 1/2" (12.7 mm); 72T; CrV 6140;
- 1/2" (12.7 mm); (450 mm); CrV 50BV30;
- 6, 7, 8, 9, 10, 11, 12, 13, 14, 15, 16, 17, 18, 19, 20, 21, 22, 24 mm; CrV;
- 6x100, 6x150, 8x200 mm; CrV 6150;
- PH2x100, PH3x150, PH3x200 mm; CrV 6150;
- 180 mm; CrV;
- 160 mm; CrV;
- 160 mm; CrV;
- 1.5, 2, 2.5, 3, 4, 5, 6, 8, 10 mm; CrV 6150



YATO	size / rozmiar (mm)	
YT-3895	475x230x365	1

GB Tool box with tools *RUS* Инструментальный ящик *RO* Cutie pt. scule *E* Caja de herramientas
D Werkzeugkoffer *CZ* Nástrojová skřínka *F* Boîte d'outils *CN* 工具组套
PL Skrzynka z narzędziami *H* Szerszámoszláda *I* Cassetta degli attrezzi



80 PCS	1/2" 12.5mm	1/4" 6.3mm	CrV 50BV30	CrV 6140
S2	72T	AS-DRIVE	⊖	⊕



- 1/2" (12.7 mm): 10, 11, 12, 13, 14, 15, 17, 19 mm (L=38 mm);
- 1/4" (6.3 mm): 5, 6, 7, 8, 9, 10, 11, 12, 13 mm (L=25 mm); CrV 50BV30;
- 1/2" (12.7 mm): 21 mm; CrV 50BV30;
- 1/2" (12.7 mm); (255 mm); 72T; CrV 6140;
- 1/4" (6.3 mm); (150 mm); CrV 50BV30;
- 1/4" (6.3 mm) x 1/4" (6.3 mm); CrV 50BV30;
- 1/4" (6.3 mm): 3 (x2), 4 (x2), 5 (x2), 5.5 (x2), 6 (x2) mm (L=25 mm); AISI S2;
- 1/4" (6.3 mm): PH0, PH1 (x2), PH2 (x2), PH3 (L=25 mm); AISI S2;
- 1/4" (6.3 mm): PZ0, PZ1 (x2), PZ2 (L=25 mm); AISI S2;
- 6, 7, 8, 9, 10, 11, 12, 13, 14, 15, 17, 19 mm; CrV;
- 5x75 mm, 6x100 mm, 8x150 mm, PH1x75 mm, PH2x100 mm; S2;
- 180 mm; CrV; 160 mm; CrV; 160 mm; CrV;
- 250 mm; 300 g; 18 mm; SK2; 18x0.5 mm; SK2;
- 1.5, 2, 2.5, 3, 4, 5, 5.5, 6 mm; T10, T15, T20, T25, T27, T30, T40; CrV



YATO	size / rozmiar (mm)	
YT-38951	460x220x245	1

GB Oil filter wrench
D Ölfilterschlüssel
PL Klucz do filtra oleju
RUS Ключ к масляному фильтру
CZ Klíč na olejový filtr
H Olajsűrő leszedő
RO Cheie pt. filtru de ulei
F Clé au filtre d'huile
I Chiave per filtro olio
E Llave para el filtro de aceite
CN 滤清器扳手



SLIDING CARD



YATO	Ø (mm)	
YT-0820	60-73	12/48
YT-0821	73-85	12/48
YT-0822	85-95	12/48
YT-0823	95-111	12/48

GB Belt oil wrench
D Ölfilterschlüssel mit Riemen
PL Klucz taśmowy do filtrów oleju
RUS Ключ тросовый для масляных фильтров
CZ Klíč na olejové filtry
H Olajsűrő leszedő
RO Cheie filtru cu banda
F Clé au filtre d'huile
I Chiave a nastro per filtro olio
E Llave de cinta para filtros de aceite
CN 皮带钳扳手



BLISTER CARD



YATO	Ø (mm)	
YT-0824	80-160	6/60
YT-0825	100-200	5/20

GB Oil filter wrench
D Ölfilterschlüssel
PL Klucz do filtra oleju
RUS Съёмник масляных фильтров
CZ Klíč na filtr oleju řetězový
H Olajsűrő leszedő, 3 körmős
RO Cheie filtru ulei cu lanț
F Clé au filtre d'huile
I Chiave per filtro olio
E Llave do filtro de cadenta
CN 滤清器扳手



COLOR BOX



63-120 mm	3/8" 10.0 mm	1/2" 12.5 mm
2.5-4"	HRC 40-50	CrV

YATO	
YT-0826	12/36

- GB Cap type oil filter wrench set
- D Steckschlüsselsatz für den Ölfilter
- PL Zestaw kluczy nasadowych do filtra oleju
- RUS Набор торцовых ключей к масляному фильтру
- CZ Sada miskovitých klíčů na olejové filtry
- H Dugókulcs készlet olajsűrőhöz
- RO Set de chei tubulare pt. filtru de ulei
- F Set d'embouts aux filtres d'huile
- I Set di chiavi filtro olio
- E Juego de llaves de tubo para el filtro de aceite
- CN 碗型滤清器扳手组套



15
PCS

FIBRE
REINFORCED
POLYMER

3/8"
10mm

BMC
& COLOR
SLEEVE



YATO	O	
YT-0595	3/8" (9.5 mm)	5

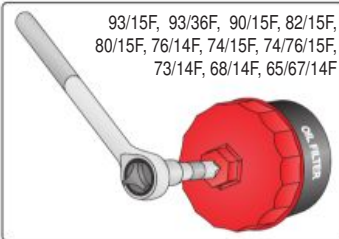

93/15F, 93/36F, 90/15F, 82/15F,
80/15F, 76/14F, 74/15F, 74/76/15F,
73/14F, 68/14F, 65/67/14F

- GB Cap type oil filter wrench set
- D Steckschlüsselsatz für den Ölfilter
- PL Zestaw kluczy nasadowych do filtra oleju
- RUS Набор торцовых ключей к масляному фильтру
- CZ Sada miskovitých klíčů na olejové filtry
- H Dugókulcs készlet olajsűrőhöz

- RO Set de chei tubulare pt. filtru de ulei
- F Set d'embouts aux filtres d'huile
- I Set di chiavi filtro olio
- E Juego de llaves de tubo para el filtro de aceite
- CN 碗型滤清器扳手组套

13 PCS	3/8" 10mm	1/2" 12.5mm	65-120 mm
------------------	---------------------	-----------------------	---------------------



BMC
& COLOR
SLEEVE

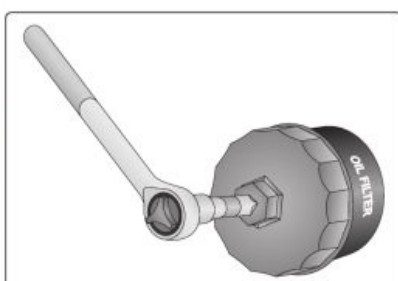

YATO	number	size	layers	grooves	faces	car models	
	number	rozmiar	warstwy	bruzdy	powierzchnie	modele samochodu	
	66/6	SW66	1	6		Fiat Punto 1.2, Renault Clio 1.2, Rapid, Twingo	
	76/8	SW76	1	8		Fiat, Lancia	
	76/12	SW76	1		12	Fiat, Mercedes, Renault	
	86/16	SW86	1		16	Volvo	
	86/18	SW86	1		18	VW Golf, Audi A6 TDI, Peugeot, Citroen	
	92/10	SW92	1		10	Fiat	
	93/45	SW93	1	45		VW, Audi TDI	
	96/18	SW96	1	18		Audi A4, A6 TDI, VQ Passat TDI, Renault Laguna	
	106/15	SW106	1		15	Fiat Ducato	
	108/15	SW108	1		15	Volvo	
	108/18	SW108	1	18		Renault Espace, Laguna, Safrane, Traffic	

- GB Cap type oil filter wrench set
- D Steckschlüsselsatz für den Ölfilter
- PL Zestaw kluczy nasadowych do filtra oleju
- RUS Набор торцовых ключей к масляному фильтру
- CZ Sada miskovitých klíčů na olejové filtry
- H Dugókulcs készlet olajsűrőhöz

- RO Set de chei tubulare pt. filtru de ulei
- F Set d'embouts aux filtres d'huile
- I Set di chiavi filtro olio
- E Juego de llaves de tubo para el filtro de aceite
- CN 碗型滤清器扳手组套

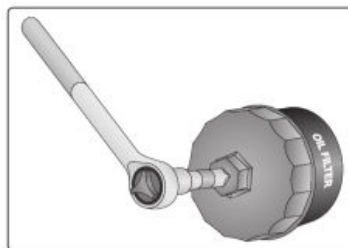

30 PCS 3/8" 10mm

BMC & COLOR SLEEVE



YATO number	size	layers	grooves	faces	car models
number	rozmiar	warstwy	bruzdy	powierzchnie	modele samochodow
66/6	SW66	1	6		Fiat Punto 1.2, Renault Clio 1.2, Rapid, Twingo
65/14	SW65	1		14	Daihatsu, Toyota, Nissan, Fiat
65/67	SW65-67	1		14	Daihatsu, Toyota
68/14	SW68	1		14	Mazda, Ford, Subaru
73/14	SW73	1		14	Toyota, Lexus
74/15	SW74	1		15	Audi, Rover, Chrysler
74/76	SW74-76	2		15	Ford, Opel, VW, Audi, Mercedes
75/77	SW75-77	2		15	VW, Audi, Isuzu, Mercedes
76/12	SW76	1		12	Fiat, Mercedes, Renault
76/14	SW76	1		14	VW, Porsche, Mercedes, BMW, Audi, Opel
76/30	SW76	1	30		Ford
76/8	SW76	1	8		Fiat, Lancia
78/15	SW78	1		15	Nissan, Ford, Toyota
80/15	SW80	1		15	Nissan, Honda, Opel, Mazda
80/82	SW80-82	2		15	Subaru, Toyota, Honda, Nissan
86/16	SW86	1		16	Volvo
86/18	SW86	1		18	VW Golf, Audi A6 TDI, Peugeot, Citroen
90/15	SW90	1		15	Honda, Mitsubishi, Isuzu
92/10	SW92	1		10	Fiat
93/15	SW93	1		15	Mazda, Volvo, Mitsubishi, Nissan, Honda
93/36	SW93	1	36		Ford
93/45	SW93	1	45		VW, Audi TDI
95/15	SW95	1		15	Toyota, Alfa Romeo, Ford
96/18	SW96	1		18	Audi A4, A6 TDI, VQ Passat TDI, Renault Laguna
100/15	SW100	1		15	Isuzu, Mitsubishi
106/15	SW106	1		15	Fiat Ducato
108/15	SW108	1		15	Volvo
108/18	SW108	1	18		Renault Espace, Laguna, Safrane, Traffic

- GB Oil filter sockets
- D Aufsätze für die Ölfilter
- PL Zestaw nasadek do filtrów oleju
- RUS Набор насадок к масляным фильтрам
- CZ Sada nástavců na olejové filtry
- H Olajsűrő leszedő készlet
- RO Set de cartușe pt. filtre de ulei
- F Set d'embouts aux filtres d'huile
- I Set di chiavi filtro olio
- E Juego de tapones para los filtros de aceite
- CN 滤油器套筒组套



4 PCS 3/8" 10mm 27 32 36 38 mm

CrV AS-DRIVE

BMC & COLOR SLEEVE



YATO YT-0598 3/8" (9.5 mm) 20

- GB Oil drain plug set
- D Ölablassschrauben Schlüsselsatz
- PL Komplet kluczy do korków oleju
- RUS Комплект ключей для сливной пробки
- CZ Klíče nástrčné na zátky olejových van motorů
- H Olajleeresztő kulcs készlet

- RO Set bituri pt. bujon ulei
- F Ensemble de clés de bouchon de vidange d'huile
- I Set di chiavi a bussola
- E Juego de llaves para tapones de aceite
- CN 排油塞旋具组套

18 PCS 3/8" 10mm

7 8 10 11 12 13 14 mm

8, 10 mm

8 9 10 12 14 17 mm

5/16" 3/8" 10 mm

CrV

- GB Oil drain plug set
- D Ölablassschrauben Schlüsselsatz
- PL Komplet kluczy do korków oleju
- RUS Комплект ключей для сливной пробки
- CZ Klíče nástrčné na zátky olejových van motorů

- H Olajleeresztő kulcskészlet
- RO Set bituri pt. bujon ulei
- F Set de clés à vindage d'huile
- I Set di chiavi per tappi olio
- E Juego de llaves para tapones de aceite
- CN 排油塞旋具组套

12 PCS 3/8" 10mm

(mm) 3/8" 3/8" 8 9 10 12 14 17



- 7, 8, 10, 11, 12, 13, 14 mm;
- 8, 9, 10, 12, 14, 17 mm;
- 5/16" (8 mm), 3/8" (10 mm);
- △ 10 mm; 10 mm;
- 160 mm

BMC & COLOR SLEEVE



YATO YT-0599 3/8" (9.5 mm) 10



BMC & COLOR SLEEVE



YATO YT-0600 10

GB Oil pan thread repair set
D Reparatursatz für Verschlußstopfen von Ölwanne
PL Zestaw naprawczy korków do miski olejowej
RUS Набор для ремонта масляных пробок
CZ Souprava na opravu vypořustěch šroubů olejových van
H Olajteknő-csavar javítókészlet

RO Set pt. reparare dopuri baie de ulei
F Kit réparation de bouchons de carter d'huile
I Set per riparazione dei tappi della coppa del olio
E Juego de reparación para los tapones del cárter de aceite
CN 螺纹修复组套

M13		M13		13 mm	
		5 pcs		10 pcs	
M15		M15		15 mm	
		5 pcs		10 pcs	
M17		M17		17 mm	
		5 pcs		10 pcs	
M20		M20		20 mm	
		5 pcs		10 pcs	



64
PCS

CrMo

BMC & COLOR SLEEVE



YATO
YT-1757 5

GB Grease gun
D Handhebel-Fettpresse
PL Smarownica ręczna
RUS Шприц для масляной смазки
CZ Páková maznice

H Karos zsírzó
RO Masina de gresat cu furturn rigid
F Pistolet de graissage manuel
I Lubrificatore manuale
E Pistola de engrase
CN 大容量黄油枪

COLOR BOX



P max. 70 MPa P 31 MPa AI

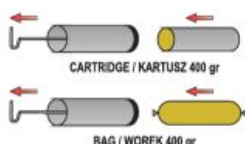

500
cm³

YATO
YT-0700 20

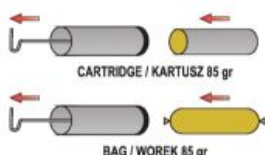

120
cm³

YATO
YT-0701 30



400
cm³

YATO
YT-0705 20

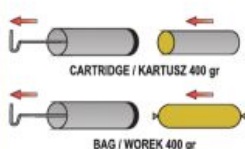

600
cm³

YATO
YT-07044 12

GB Grease gun
D Handhebel-Fettpresse
PL Smarownica ręczna
RUS Шприц для масляной смазки
CZ Páková maznice
H Karos zsírzó
RO Masina de gresat cu furturn rigid

F Pistolet de graissage manuel
I Lubrificatore manuale
E Pistola de engrase
CN 大容量黄油枪

COLOR BOX



P (MPa) 27-41 AI



600
cm³

YATO
YT-07042 6/12



800
cm³

YATO
YT-07043 4/8

- GB Two-way operation grease gun
- D Handhebel-Fettpresse
- PL Smarownica ręczna, wzmocniona
- RUS Шприц для масляной смазки
- CZ Páková maznice
- H Karos zsírító
- RO Masina de gresat cu furton rigid
- F Pistolet de graissage manuel
- I Lubrificatore manuale
- E Pistola de engrase
- CN 大容量黄油枪



500 cm³ P max. 70 MPa AI P 42 MPa

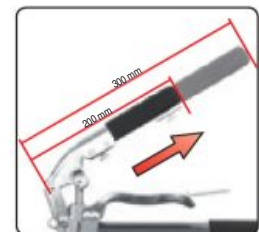

YATO
YT-0704 12



HIGH PRESSURE 69 MPa	WYSOKIE CIŚNIENIE 69 MPa	LOW PRESSURE 6.9 MPa	NISKIE CIŚNIENIE 6.9 MPa
LOW VOLUME 14 g / 40 STROKE	NISKA WYDAJNOŚĆ 14 g / 40 CYKLI	HIGH VOLUME 100 g / 40 STROKE	WYSOKA WYDAJNOŚĆ 100 g / 40 CYKLI

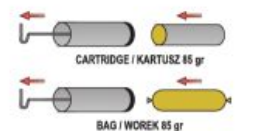

YATO
YT-07041 10

- GB Air grease gun
- D Druckluft-Fettpresse
- PL Smarownica pneumatyczna
- RUS Шприц для нагнетания
густой смазки пневматический
- CZ Mazací lis pneumatický
- H Pneumatikus zsírító
- RO Pistol pt. gresat pneumatic
- F Pistolet de graissage pneumatique
- I Pneumatica per ingrassaggio
- E Pistola engrasadora neumática
- CN 气动黄油枪



IN: 0.2-0.8 MPa

OUT: 30-40 MPa

400 cm³ 28 l/min STANDARD



L_{WA} = 93 ± 3 dB;
L_{PA} = 104 ± 3 dB;
a₁ = ≤ 2.5 m/s²

YATO
YT-07055 10

- GB Air grease gun
- D Druckluft-Fettpresse
- PL Smarownica pneumatyczna
- RUS Шприц для нагнетания
густой смазки пневматический
- CZ Mazací lis pneumatický
- H Pneumatikus zsírító
- RO Pistol pt. gresat pneumatic
- F Pistolet de graissage pneumatique
- I Pneumatica per ingrassaggio
- E Pistola engrasadora neumática
- CN 气动黄油枪



IN: 0.2-0.63 MPa

OUT: 6-28 MPa

0.63 MPa 400 cm³ 220 l/min STANDARD



L_{WA} = ≤ 70 dB;
L_{PA} = ≤ 80 dB;
a₁ = ≤ 2.5 m/s²

YATO
YT-07057 10

- GB Oil transfer pump
- D Öl-Umfüllpumpe
- PL Pompa transferowa do oleju
- RUS Шприц для перекачки масел
- CZ Ruční olejová
pumpa
- H Olajpumpa
- RO Pompa de ulei de mana
- F Pompe pour huile
- CN 输油泵
- E Bomba manual
de trasvase dual



500 cm³ P max. 70 MPa P 31 MPa



YATO
YT-0707 20

- GB Oil drainer
- D Öl-Absaugpumpe
- PL Odsysarka ręczna do oleju
- RUS Ручной шприц для откачки масла
- CZ Ruční odsávačka oleje
- H Kézi olajszivattyú
- RO Pompa de ulei
- F Seringue à huile
- I Lubrificatore manuale per aspirazione olio
- E Bomba manual de trasvase
- CN 输油泵



COLOR BOX



500 cm ³	P max. 70 MPa	P 31 MPa
------------------------	---------------------	----------------

YATO	
YT-0708	20

- GB Grease pump
- D Manuelle fettpumpe
- PL Smarownica ręczna
- RUS Шприц для смазки
- CZ Maznice ruční
- H Kézi zsíró pumpa
- RO Grăsimă manuală pompa
- F Pistolet de graissage manuel
- I Pompa manuali per grasso
- E Grasa manual de la bomba
- CN 黄油泵



GREY CARTON BOX & COLOR LABEL

13.8
MPa
(max)

1.5m
HOSE
WAZ

- GB Pneumatic grease injector
- D Druckluft-Fettpresse
- PL Towotnica smarownica pneumatyczna
- RUS Пневматический нагнетатель смазки
- CZ Pneumatické čerpadlo maziv
- H Pneumatikus zsír szivattyú
- RO Pompa de unsoare pneumatică
- F Pompe à graisse pneumatique
- I Pneumatica per ingrassaggio
- E Bomba de engrase neumática lubricar
- CN 注油器

12l	0.6-0.8 MPa	40 MPa (max)
4m HOSE WAZ	50:1 RATIO SPREZANIE	



GREY
CARTON BOX
& COLOR
LABEL



L_{PA} = 97 ± 3 dB;
L_{WA} = 108 ± 3 dB

YATO	
YT-07067	1

4kg

YATO	capacity / wydajność (kg)	
YT-07061	4	1

8kg

YATO	capacity / wydajność (kg)	
YT-07063	8	1

- GB Flexible tube for grease gun
- D Schlauch für Fettpresse
- PL Wąż do towotnicy
- RUS Шприц для перекачки масел
- CZ Hadička na maznice na šmir
- H Tömlő a zsíróhoz
- RO Furtun flexibil pt. pistol de gresat
- F Tuyau pour pistolet de graissage
- I Tubo flessibile per pompa grasso
- E Manguera para engrasador
- CN 手动黄油枪软管



SLIDING
CARD



YATO	L (mm)	
YT-0709	300	12/144
YT-0710	500	12/144

GB Oiler with a flexible applicator
 D Ölfkanne mit elastischem Applikator
 PL Oliwiarka z elastycznym aplikatorem
 RUS Масленка с гибким аппликатором
 CZ Olejníčka s ohebným aplikátorem
 H Hajlékony csövű olajozó
 RO Gresor cu aplicator flexibil
 F Burette à huile
 I Lubrificante con canna flessibile
 E Aceitera con aplicador flexible
 CN 油壺



IMPACT RESISTANT
ODPORNE NA UDZIERZENIA

YATO	cm ³	
YT-0690	220	10/120
YT-0691	270	10/120



YATO	cm ³	
YT-06912	200	10/120



IMPACT RESISTANT
ODPORNE NA UDZIERZENIA

YATO	cm ³	
YT-06913	300	10/120



IMPACT RESISTANT
ODPORNE NA UDZIERZENIA

YATO	cm ³	
YT-06914	500	10/80

GB Oil pump
 D Öl-Umfüllpumpe
 PL Pompa tłokowa do oleju
 RUS Шприц ручной заливной
 CZ Ruční olejová pumpa
 H Olajpumpa
 RO Pompa de ulei de mana
 F Pompe pour huile
 I Pompa manuale travaso fusti olio
 E Bomba manual para aceite
 CN 手摇泵

16-18 l/min
 Δh 45-90 cm
 55 min (max)
 0.3 l CYCLE
 FOR OIL DO OLEJU
 AI



YATO	
YT-0712	10

GB Aluminium rotary oil pump
 D Aluminium-Kurbelpumpe
 PL Aluminiowa pompa do oleju
 RUS Алюминиевый ручной боковой насос
 CZ Hliník rotační čerpadlo
 H Alumínium rotációs szivattyú
 RO Aluminiu pompă rotativă
 F Pompe manuelle pour huile
 I Pompa a mano per olio
 E Aluminio bomba rotary
 CN 铝合金手摇油泵

21 l/min
 Δh 500 cm
 Δh 300 cm
 3xPIPE 3xRURA
 FOR OIL DO OLEJU
 AI



YATO	
YT-07115	10

GB High value rotary barrel pump
 D Kurbelpumpe für Benzinfässer
 PL Wysokowydajna pompa rotacyjna do paliwa
 RUS Насос топливный ротационный
 CZ Čerpadlo palivové rotační
 H Kézi pumpa hordóhoz (forgatható)
 RO Pompa rotativa pt. combustibil
 F Pompe rotative à combustible
 I Pompa rotativa travaso gasolio
 E Bomba de combustible rotatoria
 CN 手摇泵

FOR FUEL, DIESEL, OIL
 DO PALIW I OLEJU
 1.0 l CYCLE
 100 l/min
 2.4 m
 180 μm
 Δh 100 cm
 AI



YATO	
YT-0715	4

- GB Two arms jaw puller
D Abzieher-2-armig
PL Ściągacz dwuramienny
RUS Съёмник для подшипников
CZ Stahovák
H Csapágyelhúzó
RO Extractor rulmenti
- F Extracteur
I Estrattore
E Extractor
CN 两爪拉马

COLOR BOX



CrV



10 mm 4" 100mm

10 mm 3" 75mm

YATO	size / rozmiar	max. Ø (mm)	max. force / max. sila nacisku (t)	CrV
YT-2514	4" / 100 mm	60	1.2	6/60

YATO	size / rozmiar	max. Ø (mm)	max. force / max. sila nacisku (t)	CrV
YT-2515	3" / 75 mm	75	1.1	6/60



12 mm 4" 100mm



17 mm 6" 150mm



22 mm 8" 200mm

YATO	size / rozmiar	max. Ø (mm)	max. force / max. sila nacisku (t)	CrV
YT-2516	4" / 100 mm	100	1.4	12/48

YATO	size / rozmiar	max. Ø (mm)	max. force / max. sila nacisku (t)	CrV
YT-2517	6" / 150 mm	120	6	10/20

YATO	size / rozmiar	max. Ø (mm)	max. force / max. sila nacisku (t)	CrV
YT-2518	8" / 200 mm	180	9	6

- GB Three arms jaw puller
D Abzieher-3-armig
PL Ściągacz trójramienny
RUS Съёмник для подшипников
CZ Stahovák třiramenný
H Csapágyelhúzó
RO Extractor rulmenti cu trei brate
- F Extracteur
I Estrattore
E Extractor detres patas
CN 三爪拉马

COLOR BOX



CrV



10 mm 3" 75mm

12 mm 4" 100mm



17 mm 6" 150mm



22 mm 8" 200mm



22 mm 12" 300mm

YATO	size / rozmiar	max. Ø (mm)	max. force / max. sila nacisku (t)	CrV
YT-2521	6" / 150 mm	130	5	12

YATO	size / rozmiar	max. Ø (mm)	max. force / max. sila nacisku (t)	CrV
YT-2522	8" / 200 mm	180	9	4

YATO	size / rozmiar	max. Ø (mm)	max. force / max. sila nacisku (t)	CrV
YT-2523	12" / 300 mm	180	11	2

- GB Three arms jaw puller
D Abzieher-3-armig
PL Ściągacz trójramienny
RUS Съёмник для подшипников
CZ Stahovák třiramenný
H Csapágyelhúzó
RO Extractor rulmenti cu trei brate
- F Extracteur
I Estrattore
E Extractor detres patas
CN 三爪拉马

COLOR BOX



CrV

14 mm 3" 75mm

YATO	size / rozmiar	Ø (mm)	CrV
YT-2511	3" / 75 mm	50-150	20

15 mm 4" 100mm

YATO	size / rozmiar	Ø (mm)	CrV
YT-2512	4" / 100 mm	60-200	20

19 mm 6" 150mm

YATO	size / rozmiar	Ø (mm)	CrV
YT-2513	6" / 150 mm	80-300	10



- GB Two leg puller for battery terminals and widescreen wiper arms

- D Abzieher für Scheibenwischer / Wischerarm Spezial-Abzieher Polklemmen
PL Ściągacz dwuramienny do klem i ramion wycieraczek
RUS Съёмник стеклоочистителя терминал батареи дворники
CZ Stahovák na svorky akumulátorů a ramen stěračů
H Akkusaru és ablaktörlőkar-lehúzó
RO Extractor brat stergator, cleme baterie
F Extracteur d'essuie glaces et cosse de batterie
I Estrattore 2 griffe
E Extractor tirador exterior para brazo del limpiaparabrisas / terminal de batería
CN 电瓶接头拉马

COLOR BOX



5-30 mm

ADJUSTABLE NASTAWNY



YATO	Ø (mm)	CrV
YT-25145	5-30	48

- GB Universal puller set
- D Abziehvorrichtung für Lager
- PL Ściągacz do łożysk w miejscach trudnodostępnych
- RUS Съёмник подшипников в труднодоступных местах
- CZ Sada na stahování ložisek na obtížně dostupných místech
- H Csapágyelhúzó
- RO Trăgător pt. rulmenți în locuri greu accesibile
- F Extracteur aux roulements
- I Set di estrattori universali
- E Extractor de rodamientos en lugares de difícil acceso
- CN 多功能拉拔器

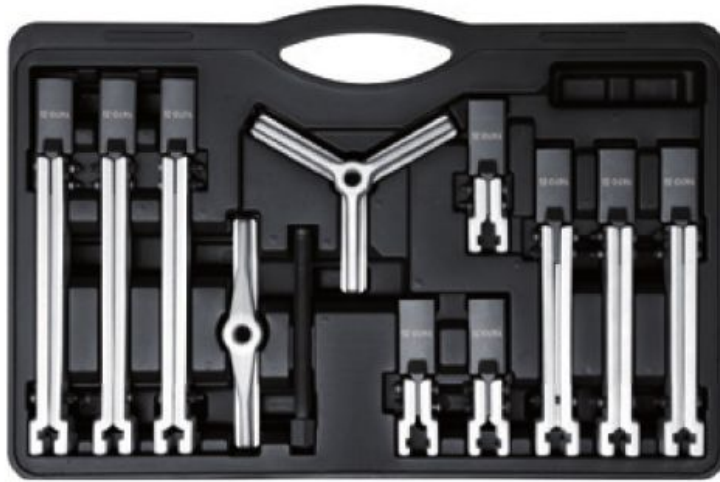
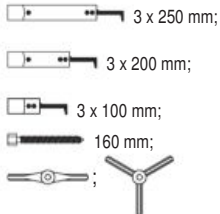

12
PCS
DROP
FORGED
KUTE

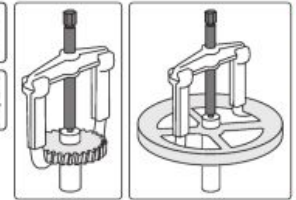

YATO	
YT-25105	2

- GB Pilot bearing puller
- D Abzieher für Innenlager
- PL Ściągacz do łożysk wewnętrznych
- RUS Съёмник внутренних подшипников
- CZ Stahovák na ložiska vnitřní
- H Csapágyelhúzó
- RO Clește interior pt. extras rulmenți
- F Extracteur intérieur aux roulements
- I Estrattore cuscinetti
- E Extractor de cojinetes inter.
- CN 轴承拉马



13-38
mm
CrV
6150



YATO	Ø (mm)	
YT-2510	13-38	20

- GB Universal wheel hub puller
- D Scheiben- und Trommelbremsen Abzieher
- PL Ściągacz uniwersalny do tarcz i bębnow
- RUS Универсальный съёмник ступицы и полуоси
- CZ Stahovák na brzdové bubny
- H Univerzális féktárcsa és fékdob lehúzó

- RO Trusa universală pt. transmisie cardanică
- F Extracteur universel pour les disques et les tambours
- I Estrattore a vite universale
- E Extractor universal de discos y tambores
- CN 万用轮毂拉马

CrV
90-140 mm
130-180 mm



YATO	L (mm)	
YT-0602	200	6

- GB Separator and hydraulic cylinder turnbuckle
- D Separator und Abziehvorrichtung mit Hydraulikservomotor
- PL Separator i ściągacz z silownikiem hydraulicznym
- RUS Сепаратор и съёмник с сервомотором
- CZ Oddělovač a stahovák s hydraulickým válcem
- H Csapágyelhúzó és körmös csapágyelhúzó hidraulikus kézpumpával
- RO Separator și ancoră cu servomotor hidraulic
- F Séparateur avec actionneur hydraulique
- I Separatore frizione cilindro idraulico
- E Separador y tensor de tornillo con cilindro hidráulico
- CN 液压分离器组合



75-105 mm
86-100 mm
50 kN
HYDRAULIC CYLINDER SILOWNIK HYDRAULICZNY
HRC 38-45
DROP FORGED KUTE
CrV



YATO	F (kN)	
YT-0609	50	2

- GB Twin leg puller with jaw hook
- D Doppel Abzieher mit Haken
- PL Ściągacz uniwersalny dwuramienny
- RUS Съёмник универсальный
- CZ Stahovák dvouarmenný univerzální
- H Csapágyelhúzó készlet
- RO Carlig cu falci pt. extras cu picor dublu
- F Extracteur universel à deux bras
- I Estrattore universale a due bracci
- E Extractor de cuatro patas
- CN 单边两爪拉马

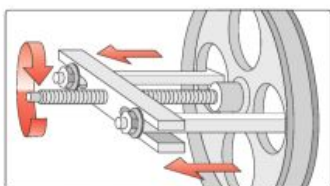
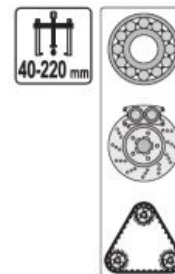

COLOR BOX

YATO	
YT-0640	10

- GB Gear puller set
- D Lagerabzieher, Trennmesser
- PL Ściągacz dwuramienny i separator
- RUS Съёмник универсальный с сепаратором
- CZ Stahovák dvouarmenný
- H Csapágyelhúzó készlet
- RO Set angrenaj pt. extras
- F Extracteur 2 bras + separateur
- I Estrattore a due bracci a separatore
- E Kit de extractor
- CN 齿轮拉拔器



BMC & COLOR BOX

YATO	
YT-0641	4

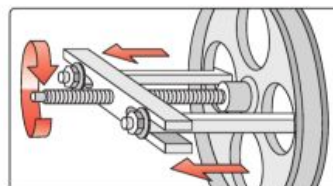
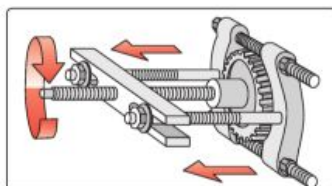
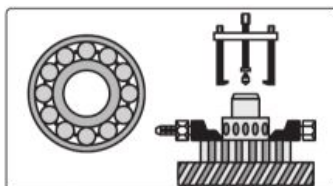
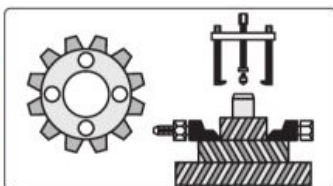

- GB Slide hammer gear / bearing puller set
- D Träge Abziehvorrichtung für Lager
- PL Ściągacz bezwładnościowy do łożysk
- RUS Набор съёмников с обратным молотком
- CZ Rázový stahovák s kluzným kladivem na ložiska
- H Csúszósúlyos csapágyelhúzó készlet
- RO Set ciocan culisant extractor de rulmenti
- F Extracteur de roulements à inertie
- I Set estrattori interni / esterni
- E Extractor de inercia para cojinetes
- CN 滑锤轴承拉拔器组套

5 PCS

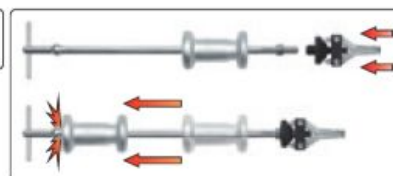

BMC & COLOR SLEEVE

YATO	
YT-2540	2

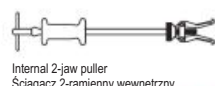
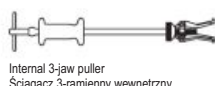

External 3-jaw puller
Ściągacz 3-ramienny zewnętrzny

External 2-jaw puller
Ściągacz 2-ramienny zewnętrzny

Internal 3-jaw puller
Ściągacz 3-ramienny wewnętrzny

Internal 2-jaw puller
Ściągacz 2-ramienny wewnętrzny

- GB** Slide hammer set
D Träge Abziehvorrichtung für Naben und Lager
PL Ściągacz bezwładnościowy do piast i łożysk
RUS Набор съемников с обратным молотком
CZ Rázový stahovák s kluzným kladivem na náboje a ložiska
H Csúszósúlyos kerékagy - és csapágyelhúzó készlet

- RO** Set ciocan culisant extractor de rulmenti și bușe
F Extracteur de roulements et moyeux à inertie
I Set estrattori per cuscinetti interno
E Extractor de inercia para cubos y cojinetes
CN 滑锤轴承拉拔器组套

16
PCS

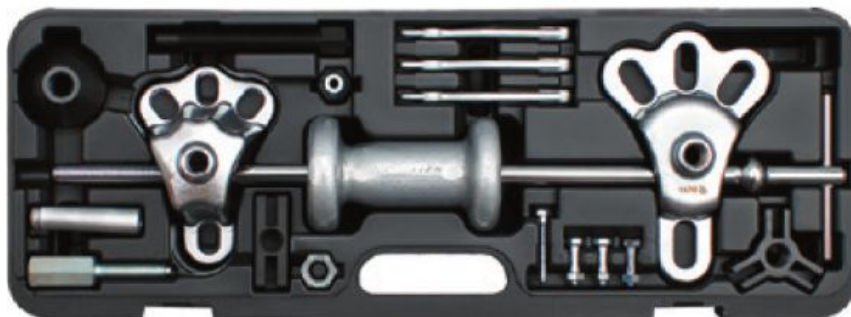
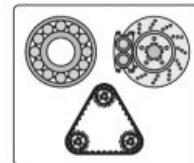
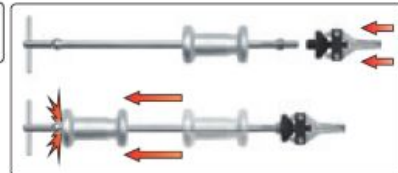

- | | | | | | | | | | | | |
|---|---|-----------------------------------|--|---|---|---|---------------------------------------|-----------------------------|---------------------------|----------------|-------------|
| Bar
Trzonek | Hammer
Miot | 2x Axle puller
2x Ściągacz osi | Grip wrench
adaptor
Prześciółka
do klucza | Nut
Kołnierz | 2-jaw head
Głowica
2-zaczkowa | 3-jaw head
Głowica
3-zaczkowa | 3x Nut & bolt
3x Nakrętka i śruba | Attachment
Gniazdo śruby | Leg
Ramię
ściągacza | Screw
Śruba | Hook
Hak |
| External 3-jaw puller
Ściągacz 3-ramienny zewnętrzny | External 2-jaw puller
Ściągacz 2-ramienny zewnętrzny | Puller hook
Hak | Dent puller
Ściągacz blacharski | Internal 3-jaw puller
Ściągacz 3-ramienny wewnętrzny | Internal 2-jaw puller
Ściągacz 2-ramienny wewnętrzny | Rear axle puller
Ściągacz tylnej osi | Grip wrench adaptor
Adapter klucza | | | | |

BMC
& COLOR
SLEEVE



YATO	
YT-25391	2

- GB** Front wheel bearing adapter set
D Radlagerabzieher werkzeugsatz vorderachse
PL Ściągacz łożysk piasty przedniej
RUS Набор для снятия переднего подшипника переднеприводных автомобилей
CZ Sada na demontáž ložisek přední nápravy
H Csapágyelhúzó adapter készlet első futóműhöz
RO Set schimbat rulment roata fata
F Extracteur de moyeux
I Set estrattori per cuscinetti ruota anteriore adattatore universale
E Extractor de cojinetes para cubos de rueda delanteros
CN 轴承拆装组套

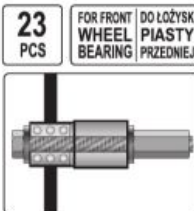
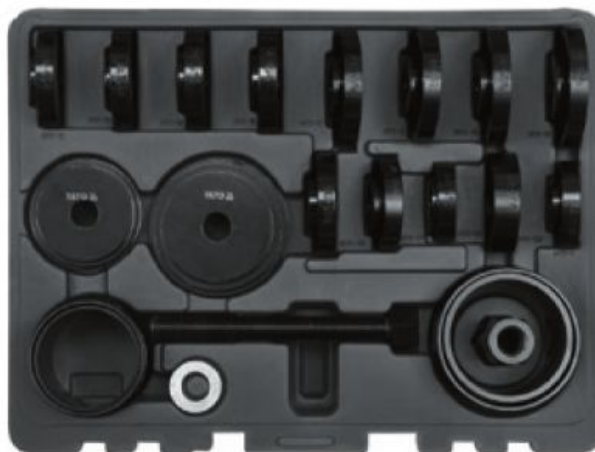

YATO	
YT-2541	2

- GB** Small mouth pull clamp
D Selbstklemmende Blechschele
PL Klamra blacharska samozaciskowa
RUS Скрепa самозажимная для жестяных работ
CZ Karosářská svěrka samosvorná k tahání

- H** Önszorító húzóató pofa, egyenes
RO Clemă pt. tablă cu strângere automată
F Boucle pour tôle auto-serrant

- I** Grappa
E Grapa de hojalateria autoprensora
CN 宽型张引夹

5t 125 mm 42x20mm JAWS SZCZEKI AUTO-TIGHTEN SAMO-ZACISKOWA

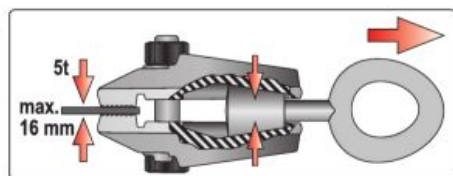

COLOR
BOX



YATO	L (mm)	
YT-2542	125	12

- GB** Box clamp
D Selbstklemmende Blechschele vom Typ „C“
PL Klamra blacharska samozaciskowa typu „C“
RUS Скрепa самозажимная для жестяных работ типа „C“
CZ Karosářská svěrka samosvorná k tahání typ „C“
H Önszorító húzóató pofa, öblös
RO Clemă pt. tablă cu strângere automată de tip „C“
F Boucle pour tôle auto-serrant

- I** Grappa tipo „C“
E Grapa de hojalateria autoprensora tipo „C“
CN 宽型张引夹

3t 142 mm 35x15mm JAWS SZCZEKI TYPE C AUTO-TIGHTEN SAMO-ZACISKOWA

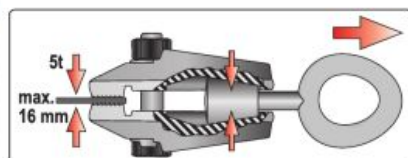

COLOR
BOX



YATO	L (mm)	
YT-2543	142	10

GB Twist socket set
D Schraubendrehersatz
PL Zestaw wykrętek do śrub
RUS Инструмент для удаления сломанных винтов

CZ Sada vytahováku stržených šroubů
H Törtcsavar kisedő készlet
RO Set de chei pt. șuruburi

F Set d'extracteurs aux vis
I Set estrattori per dadi
E Juego de destornilladores
CN 螺栓取出器组套

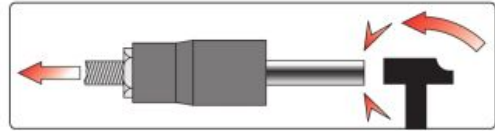

10
PCS
3/8"
10mm



BMC
& COLOR BOX



3/8" (9.5 mm): 9, 10, 11, 12,
13, 14, 15, 16, 17, 19 mm

METAL CASE
& COLOR SLEEVE



CrMo
HRC 52-55

YATO
YT-0603 20

20

YATO
YT-06031 20

20

GB Screw extractor set & HSS drill bits
D Schraubenauszehrsatz & HSS Bohrer
PL Wykrętki do zerwaných śrub i wiertła do metalu HSS
RUS Экстракторы и сверла по металлу HSS
CZ Vrtáky do přetržených šroubů & vrtáky na kov HSS
H Törtcsavar kisedő készlet + fúrószáraz fémhez HSS
RO Capete pt. deșurubat șuruburi rupte & burghie pt. metal HSS
F Set d'extracteurs aux vis
I Estrattori di vite HSS
E Destornillador para tornillos arrancados & HSS brocas
CN 断丝取出器组套



PLASTIC CASE
& COLOR BOX



12
PCS HSS
M3-M24

YATO	Ø (mm)	M	Length [mm]	Box
YT-0591	1.4-3.6	3-6	1.8	40
	2.1-4.9	6-8	2.6	
	3.1-6.5	8-11	3.7	
	4.8-8.8	11-14	5.5	
	6.2-11.0	14-18	7.0	
	9.4-15.0	18-24	10.3	

GB Universal extractor set
D Gewindeausdreh-Satz
PL Uniwersalny zestaw do wykręcania
RUS Набор инструментов для поврежденных болтов и гаек
CZ Nástrojová sada pro poškozené šrouby a matice
H Szerszámkészlet sérült csavarokhoz és anyákhoz
RO Set extractoare suruburi si piulite
F Establecer extractoare suruburi si piulite
I Set universale di cacciaviti
E Extracteurs establecer vis et écrous
CN 螺丝, 螺杆, 螺母取出器组套



17
PCS 1/2" 12.5mm 3/8" 10mm CrMo 42 CrV 50BV30

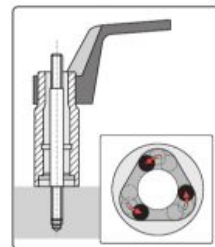

BMC
& COLOR SLEEVE



YATO
YT-06033 10

3/8" (9.5 mm): 9, 10, 11, 12, 13, 14, 16 (L=28); 19 mm (L=30) CrMo 42;
1/2" (12.5 mm): 6, 8 (L=60 mm); 10, 12 mm (L=70 mm); CrV 50BV30;
M3-M6, M6-M8, M8-M11, M11-M14, M14-M18; CrMo 42

GB Screw extractor set
D Schraubenauszehrsatz
PL Wykrętki do zerwaných śrub
RUS Набор для извлечения обломанных болтов
CZ Vrtáky do přetržených šroubů
H Törtcsavar kisedő készlet
RO Capete pt. deșurubat șuruburi rupte
F Set d'extracteurs aux vis
I Estrattori di viti
E Destornillador para tornillos arrancados
CN 断丝取出器组套



PLASTIC BOX
& SLIDING CARD



6
PCS

YATO	Ø (mm)	L (mm)	Box
YT-0590	3-6	52	12/48
	6-8	58	
	8-11	66	
	11-14	75	
	14-18	80	
	18-25	88	

- | | | |
|---|---|---|
| GB Bolt extractor set | CZ Souprava na demontáž závrtných šroubů | I Set bussole estrattore per brugola |
| D Satz von Ausziehvorrichtungen für Stifte | H Csavarkihajító készlet | E Juego de extractores de alfileres |
| PL Zestaw wykrętaaków do szpilek | RO Set de șurubelnțe pt. tije | CN 断丝取出器组套 |
| RUS Набор экстракторов для шпилек | F Set d'extracteurs aux épingles | |



STEEL 8660
HRC 49-52

LEFT

6
PCS
3/8"
10mm



YATO	Ø (mm)	
YT-0623	2; 3; 4; 6; 8; 10	50

5
PCS
1/2"
12.5mm



YATO	Ø (mm)	
YT-0624	8; 10; 12; 14; 16	20

- | | |
|--|------------------|
| GB Heavy duty nut splitter | 4
PCS |
| D Meißelsatz für Schraubenmutter | CrV |
| PL Zestaw przecinaków do nakrętek | HRC 40-45 |
| RUS Набор зубил для гаек | |
| CZ Souprava sekáčů na matice | |
| H Csavaranya-vágó | |
| RO Set retezatoare capace | |
| F Set de burins | |
| I Set estrattore dado | |
| E Juego de tajaderas para tuercas | |
| CN 螺母破拆组套 | |

5/16" - 1/2" (9 - 12 mm);
1/2" - 5/8" (12 - 16 mm);
5/8" - 7/8" (16 - 22 mm);
7/8" - 1-1/16" (22 - 27 mm)



YATO		
YT-0585		10

- | | |
|--|-----------------|
| GB Roller stud extractor set | 4
PCS |
| D Stehbolzenlösersatz | CrV |
| PL Komplet wykrętaaków do szpilek | 50BV30 |
| RUS Набор ключей для снятия штифтов | |
| CZ Sada stahovadel na špendlíky | |
| H Komplet tükkihúzó | |
| RO Set de dispozitive pt. demontat șuruburi rupte | |
| F Set d'extracteurs de goupilles | |
| I Estrattori a rulli per viti prigioniere | |
| E Juego de extractores de agujas | |
| CN 断丝取出器组套 | |

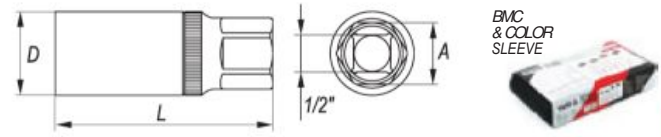

YATO	● (mm)	D (mm)	L (mm)	A (mm)	
YT-0620	6	24	60	21	6/24
	8				
	10	28	70		
	12				

- | | |
|---|------------------------------|
| GB Stud extractor | 1/2"
12.5mm |
| D Stehbolzenausdreher | 8.5-19
mm |
| PL Wykrętaak do śrub szpilek i nakrętek | |
| RUS Шпильковерт универсальный | |
| CZ Klíč na povolení závrtných šroubů | |
| H Sérültféjű csavar kiszedő | |
| RO Extractor pt. suruburi | |
| F Extracteur de goujon, écrou ou boulon arrondis | |
| I Stud estratore | |
| E Extractor de esparragos | |
| CN 断螺丝取出器 | |



YATO		
YT-06251		10/30

- | | |
|---|------------------------------|
| GB Stud extractor | FOR IMPACT TOOLS |
| D Stehbolzenausdreher | DO NARZĘDZI UDAROWYCH |
| PL Wykrętaak do śrub szpilek i nakrętek | 3 JAWIS 3 SZCZĘKI |
| RUS Шпильковерт универсальный | 6-11
mm |
| CZ Klíč na povolení závrtných šroubů | 24
mm |
| H Sérültféjű csavar kiszedő | 3/8" |
| RO Extractor pt. suruburi | CrMo |
| F Extracteur de goujon, écrou ou boulon arrondis | HRC40-45 |
| I Stud estratore | |
| E Extractor de esparragos | |
| CN 断螺丝取出器 | |



FOR IMPACT TOOLS
DO NARZĘDZI UDAROWYCH

3 JAWIS 3 SZCZĘKI

6-11
mm

24
mm

3/8"

CrMo
HRC40-45



YATO		
YT-06255		6/36

- GB Tie rod end lifter
D Universal-Kugelgelenk-Abzieher
PL Ściągacz do sworzni kulistych
RUS Съёмник шаровых опор
CZ Stahovák kulových čepů řízení
H Gömbfej kinyomó
RO Extractor pt. articulatii sferice
F Extracteur de rotue
I Estrattore per snodi sferici
E Extractor de pernos esféricos
CN 球头拉拔器



100 mm 20-60 mm

YATO	(mm)	L (mm)	Ø (mm)	
YT-06122	19	100	20	20

COLOR BOX



135 mm

YATO	(mm)	L (mm)	Ø (mm)	
YT-0612	19	135	17.5	9/18



265 mm 275 mm

YATO	(mm)	L (mm)	Ø (mm)	
YT-0613	16	265	17	20
YT-0614	16	275	20	20

- GB Rod end remover
D Lenkstangeabzieher
PL Ściągacz do drążków kierowniczych
RUS Съёмник рулевых тяг
CZ Přípravek na demontáž kulových čepů řízení
H Gömbfej kiütő

- RO Tija pt. indepartat
F Extracteur pour rotules de direction
I Estrattori perni e tiranti sterzo
E Extractor de barras de acoplamiento
CN 拉拔器

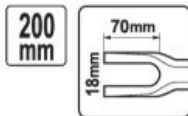

COLOR BOX

YATO	L (mm)	
YT-0615	200	18/36

- GB Inner tie rod tool
D Spurstangengelenk Lösewerkzeug
PL Klucz do drążków kierowniczych
RUS Ключ для шарнира рулевой рейки
CZ Přípravek na axiální táhla
H Csukló szerelő
RO Cheia de la tija de cravată
F Clé pour pour rotules de direction
I Chiave per il tirante
E Extractor mecanismo de dirección
CN 大机枪扳手

Ø mm 35-42



COLOR BOX



YATO	
YT-06160	25

- GB Track rod end remover & installer set
D Schlüsselsatz für Zahnstangenlenkung
PL Zestaw kluczy do drążków kierowniczych
RUS Набор ключей для рулевых тяг
CZ Sada klíčů pro hřeben řízení
H Kormányrúd telepítő készlet-eltávolító

- RO Set montare-demontare bieleta
F Clé pour rotules de direction
I Set di chiavi suggerimenti smontaggio tiranti sterzo
E Herramienta de llaves para barras de dirección
CN 件套轴接头工具组

4 PCS
Ø mm 30-45



Ø 30-35mm, 35-40mm, 40-45mm

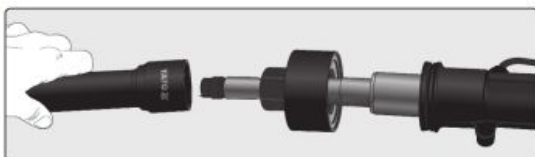

BMC & COLOR SLEEVE



YATO	
YT-06155	2

- GB Tie rod / ball joint tool kit
D Werkzeugsatz für Bremssattel
PL Ściągacze do drążków
RUS Съёмник штанг
CZ Stahováky táhel řízení
H Rúdlehűző
RO Ancore pt. tije
F Set d'extracteurs pour rotules de direction
I Set tiranti per estrattore
E Tensores para palancas
CN 球头拉拔器组套

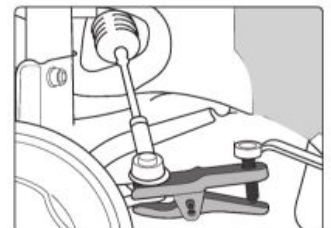

6 PCS



BMC & COLOR SLEEVE



YATO	
YT-06157	4

- GB Tie rod / ball joint tool kit
- D Werkzeugsatz für Bremssattel
- PL Ściągacze do drążków
- RUS Съемник штанг
- CZ Stahováký táhel řízení
- H Rútlehúzó
- RO Ancore pt. tije
- F Set de leviers à tête réglable
- I Set di estrattori perni e tiranti sterzo
- E Tensores para palancas
- CN 球头拉拔器组套

for / dla: YT-0990

5
PCS



BMC & COLOR BOX

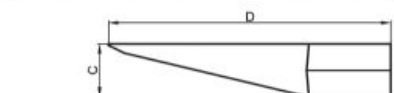
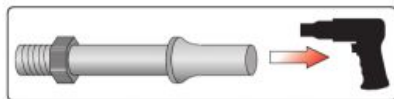
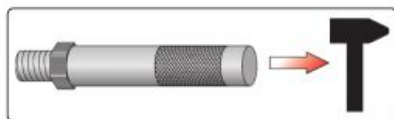

1/2"-12 UNC-2B

YATO		A (mm)	B (mm)	C (mm)	D (mm)	
YT-0616	I	18.2	65.0	24.0	123.9	10
	II	25.2	67.8			
	III	30.2	56.3			

- GB Seal puller
- D Dichtungs-Abziehwerkzeug
- PL Ściągacz do uszczelek
- RUS Съемник прокладок
- CZ Škrabka na těsnění
- H Tömítéslehúzó
- RO Ancoră pt. garnituri
- F Outil pour extraire les joints
- I Estrattore per guarnizioni
- E Tensor para juntas
- CN 密封圈拉拔器



max. 85mm

SLIDING CARD

YATO	L (mm)	
YT-0642	200	12/48

- GB Bearing race and seal driver set
- D Presssatz für sicherungsringe, lager, etc.
- PL Zestaw do osadzania łożysk i uszczelniaczy
- RUS Втулка и набор сальниковых уплотнителей для автомобиля
- CZ Sada na montáž gufer
- H Csapágó, szimering, persely ki- és beütő készlet
- RO Set pt. înlocuit rulment, simering
- F Set de simerings
- I Set di tamponi per cuscinetti e guarnizioni
- E Jugeo de conductores del anillo y del sello de rodadura
- CN 斜型培令套安装器



10
PCS

AI

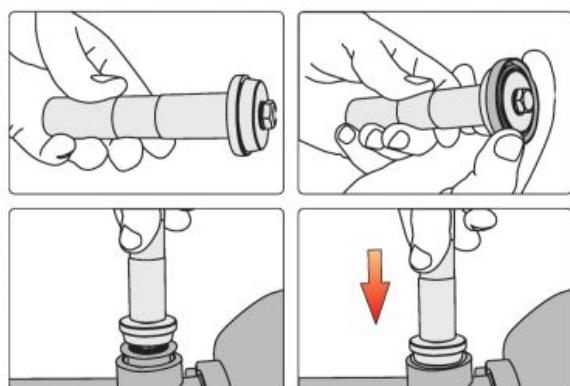

BMC & COLOR SLEEVE



YATO	No.	∅ (mm)	
YT-0638	01	40	5/10
	02	44	
	03	50	
	04	59	
	05	63	
	06	65	
	07	72	
	08	76	
	09	81	

- GB** Car radio removal tool set
D Autoradio Demontage Werkzeugsatz
PL Zestaw do demontażu radioodbiorników samochodowych
RUS Набор для разборки авто-ресиверов
CZ Sada k demontáži autorádií
H Autórádió kiszerező készlet
RO Trusa de scule pt. indepartat radio
F Set d'outils pour dépose autoradio
I Set estrattori per autoradio
E Juego para el desmontaje de autorradio
CN 收音机拆卸组套

- 2 radio removal U-hook (Ford, VW, Audi, Grundig, Blaupunkt)
- 1 special pentagon wrench (BMW)
- 4 radio removal keys (VW, Audi, Becker, Mercedes)
- 2 radio removal keys (Mercedes, Porsche, Becker)
- 2 radio removal keys (VW)
- 1 allen hex wrench (BMW, Opel)
- 2 radio removal keys (new Becker)
- 2 radio removal keys (new Skoda)
- 2 radio removal keys U-hook (new Blaupunkt)
- 2 radio removal keys (Fiat Brava)
- 2 radio removal U-hook (Opel Doppel-Kugel-Inbus)
- 6 radio removal keys (Mercedes-Benz, BMW)
- 2 radio removal keys (Kenwood II 1998-2001)
- 2 radio removal keys (Sony II since 2002)
- 2 radio removal keys (Kenwood III since 2002)
- 2 radio removal keys (Pioneer, JVC)
- 2 radio removal keys (Sony I until 2001)
- 2 radio removal keys (Panasonic)
- 2 radio removal keys (Kenwood I until 1998)
- 2 radio removal keys (Kenwood mask)
- 2 radio removal keys (new Clarion)
- 2 radio removal keys (old Clarion)
- 2 radio removal keys (Panasonic 2006)
- 2 radio removal keys (Sony IDIC 2005)



52
PCS

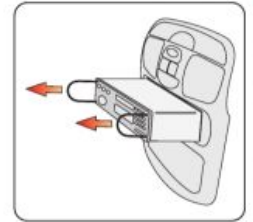
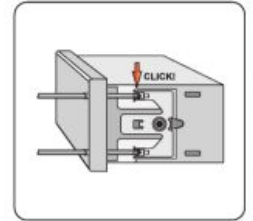

BMC
& COLOR
SLEEVE



YATO
YT-0838 10

- GB** Emergency automotive lock-out tool set
D Werkzeugsatz zum Öffnen der Autotür im Notfall
PL Zestaw do awaryjnego otwierania drzwi samochodowych
RUS Набор для аварийного відкриття автомобільних дверей
CZ Souprava k nouzovému otevření dveří automobilů
H Személygépkocsi ajtó vésznyitó készlet
RO Set pt. deschiderea de avarie a ușilor de mașină
F Set ouverture de porte fermée
I Set estrattori per apertura automotore
E Juego de herramientas para abrir las puertas de coche en casos de urgencia
CN 车门锁拆卸工具

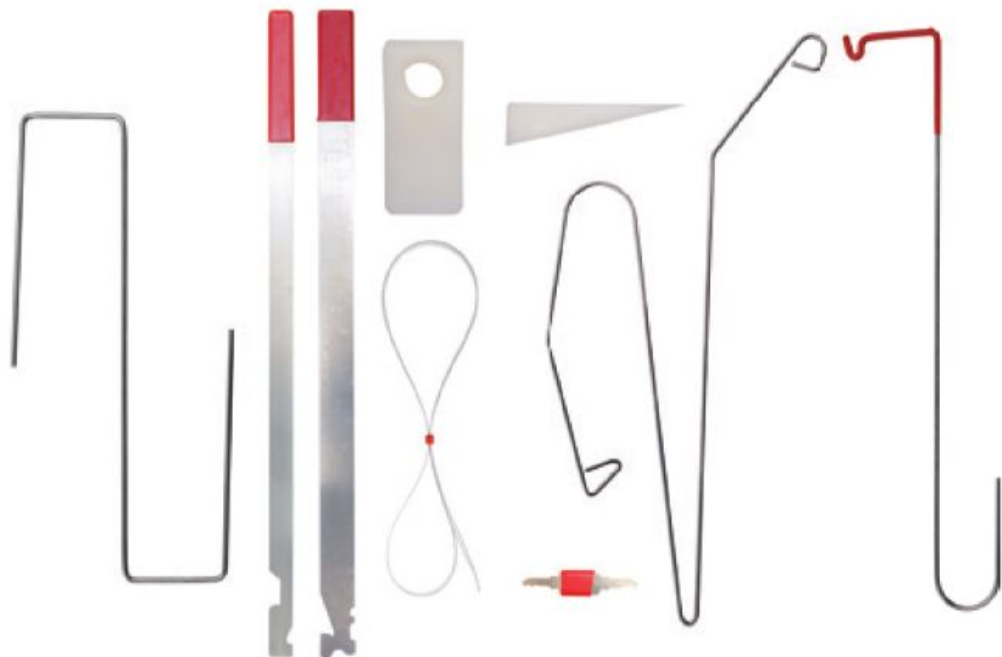

9
PCS

SS
STAINLESS STEEL
EPL. NIKROZELWA

PVC



POUCH

YATO
YT-08385 25

GB Door upholstery remover
D Abziehvorrichtung
für Polsterklammern
PL Ściągacz do spinek tapicerki
RUS Съемник крепежа обивки

CZ Uvolňovač čalounění dveří
H Kárpitkiszedő
RO Dispozitiv de scos agrafe
de tapițerie

F Arrache agrafes
I Estrattore per la rimozione
di graffette tappezzeria

E Extractor de grapas
de vestidura
CN 胶扣起子

SVCM



YATO	size / rozmiar (mm)	
YT-1370	6x100	12/120

YATO	size / rozmiar (mm)	
YT-1371	6.2x115	12/120



YATO	size / rozmiar (mm)	
YT-1372	10x115	12/120

YATO	size / rozmiar (mm)	
YT-1373	9.5x134	6/96

GB Scratch awl
D Einfache Spicknadel
PL Szpikulec prosty
RUS Прямое острие

CZ Šídlo rovné
H Spékélőtű, egyenes
RO Dorn perforare drept
F Brochette droite
I Punteruolo
piatto
E Punzón recto
CN 锥子

SVCM

GB Hook bodkin
D Hakenspicknadel
PL Szpikulec hakowy
RUS Крючковое острие
CZ Šídlo háčkové
H Spékélőtű, horgos

RO Dorn perforare indoit
F Brochette coudée
I Gancio punteruolo
E Punzón encorvado
CN 油封拉拔器

SVCM 90°



YATO	L (mm)	
YT-1374	120	12/120

YATO	L (mm)	
YT-1375	125	12/120

GB Battery cap tool
D Abziehvorrichtung für Akkuklemmen
PL Ściągacz do klemm akumulatora
RUS Стяжка для клемм аккумулятора
CZ Stahovák svorek akumulátoru
H Akkumulátor saru leházó

RO Extractor pt. cleme acumulator
F Tournevis plat pour bouchons
de batterie
I Batteria clem estrattore
E Extractor para los bornes de la batería
CN 扁铲

SVCM

GB Glass scraper
D Scheibenkratzer
PL Skrobak do szyb
RUS Шабер для стекла

CZ Škrabka na okna
H Jégkaparó
RO Răzuitor geamuri
F Gratteur pour vitres
I Raschietto per vetro
E Rascador para los vidrios
CN 刮刀

SVCM



YATO	size / rozmiar (mm)	
YT-1378	18.5x100	12/120

YATO	size / rozmiar (mm)	
YT-1379	39x200	6/72

GB Spare blades for glass scraper
D Abbrechklingen
PL Ostrze do skrobaka do szyb
RUS Лезвия для универсальных
ножей
CZ Lomené ostří náhradní
H Törhető tartalékpenge
RO Lame de rezervă rupte

F Lames pour gratteur pour vitres
I Lame per raschietto
E Filo partito de schimb
CN 刮刀刀片

10 PCS SK5

for / dla: YT-1379



COLOR BOX

YATO	(mm)	
YT-13790	19x39	50

GB Flexible spinner
D Elastischer Dreher
PL Pokrętko elastyczne
RUS Эластичный
вороток

CZ Šroubovák ohebný
H Hajlékony
csavarhúzó
RO Mâner flexibil

F Barre élastique
I Chiave flessibile
E Llave flexible
CN 套筒螺丝批

1/4" 6.3mm SVCM



YATO	size / rozmiar	
YT-1381	1/4" (6.3 mm) x 150 mm	6/96

GB Flexible magnetic bit driver
D Elastischer Dreher für Bits
PL Pokrętko elastyczne do bitów

RUS Эластичный вороток для разряда битов
CZ Šroubovák ohebný na bity
H Hajlékony csavarhúzó, hosszú

RO Mâner flexibil pt. vârf șurubelniță
F Barre élastique
I Chiave flessibile

E Mango flexible para desarmadores
CN 批头螺丝批

SVCM



YATO	size / rozmiar	
YT-1382	1/4" (6.3 mm) x 380 mm	6/72

GB Flexible magnetic pick up tool
D Elastische Magnethalterung
PL Elastyczny uchwyt magnetyczny

RUS Эластичный магнитный держатель
CZ Ohebný magnetický držák
H Hajlékony csavarhúzó,

hosszú, mágneses
RO Mâner magnetic flexibil
F Capteur magnétique

I Chiave flessibile
E Mango magnético flexible
CN 捡拾器

SVCM



YATO	L (mm)	
YT-1385	400	6/72

GB Door upholstery remover
D Abziehvorrichtung
für Polsterklammern
PL Ściągacz do spinek tapicerki
RUS Съемник крепежа обивки

CZ Uvolňovač čalounění dveří
H Kárpitkiszedő
RO Dispozitiv de scos agrafe
de tapițerie
F Spatule d'extraction de clips

I Estrattore per la rimozione
di graffette tappezzeria
E Extractor de grapas de vestidura
CN 胶扣起子

SLIDING
CARD



YATO	L (mm)	
YT-0841	230	16/64

YATO	L (mm)	
YT-0842	200	25/100

- GB Panel removal set
D Abziehvorrichtung für Polsterung
PL Ściągacze do tapicerki
RUS Съемник обивки
CZ Sada k demontáži čalounění
H Kárpitlehúzó
RO Ancore pt. tapițerie
F Set d'extracteurs à la tapisserie
I Leve in plastica per la tappezzeria
E Tensores para las vestiduras
CN 面板拆卸组套

DOUBLE
BLISTER



IMPACT
RESISTANT
NYLON
ODPORNE
NA DEZCZNIĘ
NO SCRATCH
BEZ
ZADRAPAN



5
PCS

YATO
YT-0836

6/24



6
PCS

YATO
YT-0837

6/24

- GB Panel removal set
D Abziehvorrichtung für Polsterung
PL Ściągacze do tapicerki
RUS Съемник обивки
CZ Sada k demontáži čalounění
H Kárpitlehúzó
RO Ancore pt. tapițerie
F Set d'extracteurs à la tapisserie
I Leve in plastica per la tappezzeria
E Tensores para las vestiduras
CN 面板拆卸组套

POUCH
& COLOR
BOX



11
PCS



YATO
YT-0844

5/10

- GB Set of plastic scrapers
D Satz von Kunststoffschabern
PL Zestaw skrobaków plastikowych
RUS Набор пластмассовых шпателей
CZ Souprava plastových škrabek
H Műanyag vakaró készlet

- RO Set de răzuitoare din plastic
F Kit de grattoirs en plastique
I Set di raschietto
E Juego de rascadores de plástico
CN 塑料刮刀

4
PCS

265
mm

IMPACT
RESISTANT
NYLON
ODPORNE
NA DEZCZNIĘ
NO SCRATCH
BEZ
ZADRAPAN



3/4" (19 mm) 7/8" (22 mm) 1" (25 mm) 1.1/2" (37.5 mm)

SLIDING
CARD



YATO
YT-0847

L (mm)

265

6/36

16

- GB Quick release cut out tool
D Schneidmesser für Scheiben
PL Nóż do wycinania szyb
RUS Нож для вырезания стекол
CZ Nůž na vyřezávání skel
H Szélvédőkivágó kés
RO Cuțit tăietor de geam
F Kit de découpe pare-brise
I Tagliolo per il verto
E Cuchilla para cortar cristales
CN 玻璃橡胶刮除器



3x
BLADES
OSTRZA

Alu
HANDLE
UCHWYT

QUICK
RELEASE
SZYBKO-
ZŁĄCZE

K5

SLIDING
CARD



YATO
YT-0659

20/40

- GB Spare blades for cut out tool
D Abbrechklengenn
PL Ostrza zapasowe do noża do wycinania szyb
RUS Лезвья для ножей
CZ Ostří náhradní
H Törhető tartalékpenge
RO Rezerve cutter
F Lames
I Lame di ricambio per coltello specialistica per tagliare vetri del auto
E Filo partido de recambio
CN 玻璃橡胶刮除器刀片



3x
BLADES
OSTRZA

K5

for / dla: YT-0659

SLIDING
CARD



3/4" (19 mm);
1" (25 mm);
1-1/2" (38 mm)

YATO
YT-06590

10/80

- GB Windshield removal set
- D Demontagesatz für Autoscheiben
- PL Zestaw do demontażu szyb samochodowych
- RUS Набор для демонтажа автостекла
- CZ Souprava na demontáž autoskel
- H Szélvédőcserélő szett
- RO Set pt. demontarea geamurilor de maşină
- F Kit pour démontage de vitres de voiture
- I Set di strumenti di rimozione parabrezza
- E Juego para desmontaje de cristales de coches
- CN 风挡玻璃拆卸组套



7 PCS HRC 38-42



COLOR BOX

YATO YT-0845 10

- GB Windscreen wiper arm removal tool
- D Abziehvorrichtung für die Scheibenwischerarme
- PL Ściągacz do ramion wycieraczek
- RUS Съёмник поводков стеклоочистителя
- CZ Stahovák na ramínka stěračů
- H Ablaktörökár lehűző
- RO Siguranță pt. brațele ștergătoarelor
- F Bord aux bras d'essuie-glace

- I Estrattore di parabrezza tergicristallo braccio
- E Herramienta para desmontaje de las plumas de los limpiaparabrisas
- CN 雨刷臂拆卸工具



SLIDING CARD



YATO YT-0846 12/120

- GB Two leg puller for battery terminals and windscreen wiper arms
- D Abzieher für Scheibenwischer / Wischerarm Spezial-Abzieher Polklemmen
- PL Ściągacz dwuramienny do klem i ramion wycieraczek
- RUS Съёмник стеклоочистителя терминал батареи дворники
- CZ Stahovák na svorky akumulátorů a ramen stěračů
- H Akkusaru és ablaktörökár-lehűző
- RO Extractor brat stergator, cleme baterie
- F Extracteur d'essuie glaces et cosse de batterie
- I Estrattore 2 griffe
- E Extractor tirador exterior para brazo del limpiaparabrisas / terminal de batería
- CN 电瓶接头拉马



5-30 mm

ADJUSTABLE NASTAWNY

COLOR BOX



YATO YT-25145 5-30 48

16

- GB Spring clamp remover V.A.G.
- D Auspuff Federklammer entferner / installer für V.A.G.
- PL Ściągacz do obejm i sprężyn V.A.G.
- RUS Съёмник пружинных, хомутов систем выпуска V.A.G.
- CZ Přípravek na montáž a demontáž svorky výfuku V.A.G.
- H Kipufogó rugó szerelő V.A.G.
- RO Dispozitiv montat / demontat esapament V.A.G.
- F Tuyau d'échappement printemps pince outil de suppression pour V.A.G.
- I Spring clamp rimozione
- E Abrazadera de resorte herramienta de eliminación-para V.A.G.
- CN 弹簧撑

17 mm

FOR / DLA V.A.G.

SLIDING CARD



YATO YT-25331 12/24

- GB Puller for ribbed drive pulley
- D Riemenscheiben Abzieher Werkzeug Keilriemenscheiben
- PL Ściągacz kół pasowych wielorowkowych
- RUS Универсальный съёмник шкива
- CZ Staviteľný stahovák drážkových řemenic
- H Bordás szjítárcsa lehűző
- RO Tragator de scripete reglabil
- F Universel extracteur de poulie d'entraînement cannelé
- I Estrattore puleggia motrice a coste
- E Extractor de polea acanalada
- CN 皮带轮拉马

40-165mm

17mm



COLOR BOX



YATO YT-25480 10

- GB Universal pulley puller
D Universal-Riemenscheiben-Abzieher
PL Ściągacz uniwersalny do kół rozrzadu
RUS Съёмник шкивов универсальный
CZ Stahovák ozubených kol
H Univerzális leházó
vezérműtengely szjtjárca
RO Extractor universal
pt. roata distributie
F Extracteur de poulie universel
I Estrattore universale
per ruote di albero a camme
E Extractor de poleas universal
CN 皮带轮拉马



24 mm
8 SETTINGS
USTAWIENIA
60-90 mm
3 ARMS
RAMIONA

COLOR BOX



YATO
YT-06340 10

- GB Universal pulley puller
D Universal-Riemenscheiben-Abzieher
PL Ściągacz uniwersalny do kół rozrzadu
RUS Съёмник шкивов универсальный
CZ Stahovák ozubených kol
H Univerzális leházó
vezérműtengely szjtjárca
RO Extractor universal
pt. roata distributie
F Extracteur de poulie universel
I Estrattore universale
per ruote di albero a camme
E Extractor de poleas universal
CN 皮带轮拉马



17 mm
6 SETTINGS
USTAWIENIA
50-80 mm
3 ARMS
RAMIONA



ADJUSTABLE / NASTAWNY

COLOR BOX



YATO
YT-06341 10

- GB Fuel tank sender unit spanner
D Tankgeberschlüssel
PL Klucz pazurowy do pompy paliwa
RUS Ключ для крышки
топливного насоса
CZ Nastavitelný klíč na šrouby
palivových nádrží
H Üzemanyag jeladó kisérdő
RO Cheie reglabila pt. pompa
combustibil pe rezervor
F Outil de démontage
de pompe
I Chiave smontaggio
galleggiante serbatoio
E Llave de tres
garras para afador
CN 油箱盖拆装工具



24mm
75-160 mm
3 REGULATED
ARMS
3 REGULOWANE
RAMIONA

COLOR BOX



YATO
YT-06288 40

- GB CV boot clamp pliers
D Zange für Schellen der Gelenkabdeckung
PL Szczypce do opasek osłony przegubu
RUS Щипцы для хомутов крепления
кожуха шарнира
CZ Kleště na spony manžety kloubu
H Féltegely bilincs húzó fogó
RO Clește pt. brățară de husă la articulație
F Pince pour collier à recouvrement de joint
I Pinza a morsetto per fascette pinzabili
E Alicates para abrazadera
de protección de la junta
CN 夹紧钳



SLIDING CARD



235 mm

CrV

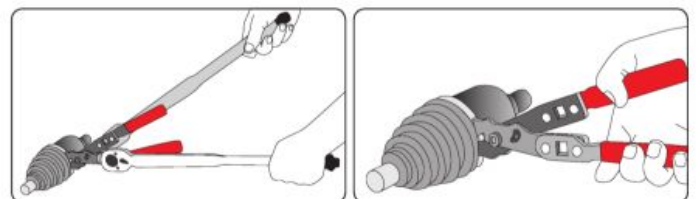

YATO L (mm)
YT-0606 235 6/36

- GB Fuel feel pipe pliers
D Zange für Tankverschlüsse
PL Szczypce do złączek paliwowych
RUS Щипцы для топливных соединений
CZ Kleště na spojky palivového systému
H Üzemanyagvezeték fogó
RO Clește pt. conectoare de combustibil
F Pince tenaille pour connecteurs de carburant
I Pinza per tubo carburante
E Alicates para enchufes
de combustible
CN 油管钳



SLIDING CARD



AI

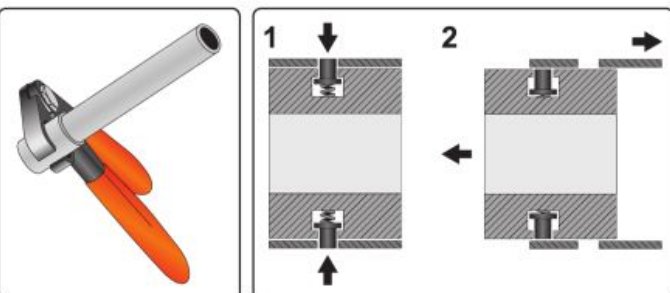

YATO
YT-0608 10/40

- GB Lock-ring pliers
D Spreizzange für Schellen
PL Szczypce rozporowe do pierścieni osadczyc
RUS Щипцы распорные для стяжных хомутов
CZ Kleště na hadicové spony
H Seeger fogó
RO Clește pt. desfacerea brățarelor de strângere
F Pince tenaille pour les bagues de retenue
I Pinza per rondelle elastiche scanalata
E Alicates para abrazaderas
CN C型扣钳



SLIDING CARD



225 mm

CrV



YATO L (mm)
YT-0607 225 12/72

- GB Hose removing pliers
- D Schlauch- und Kabellösezange
- PL Szczypce do zdejmowania przewodów
- RUS Клещи для снятия изляции
- CZ Kleště na demontáž hadic
- H Tömlőbilincs fogó
- RO Clește pt. indepartat furtune
- F Pince pour enlever les fils
- I Pinza spelacavi universale
- E Alicates de extracción de mangueras
- CN 油管分离钳



SLIDING CARD



YATO
YT-0657 6/36

- GB Transmission line disconnect tool set
- D Werkzeugsatz zum Trennen von Kraftstoffleitungen
- PL Zestaw do rozłączania przewodów
- RUS Набор для рассоединения топливопроводов
- CZ Sada na rozpojování palivového potrubí
- H Üzemanyagcső-lebontó készlet
- RO Set pt. deconectarea liniilor de combustibil
- F Set pour disjoindre des câbles
- I Set per scollegare i tubi di carburante
- E Juego para desconectar conductos de combustible
- CN 油管拆卸组套



8 PCS
FOR A/C
DO KLIMATYZACJI
FOR FUEL LINE
DO PRZEWODÓW PALWA



YATO
YT-0630 20

- GB Spark plug puller set VAG
- D Abzieher-Satz Zündspulen VAG
- PL Zestaw ściągaczy do cewek zapłonowych VAG
- RUS Набор съемников для катушек зажигания VAG
- CZ Sada stahovákú zapalovací cívký
- H Gyújtótekercs lehúzó készlet
- RO Set bobina de aprindere tragator
- F Set d'extracteurs des bobines d'allumage
- I Set per la rimozione rapida bobine di accensione nelle auto VAG
- E Extractores bobinas de encendido grupo VAG
- CN 四件套火花塞维修工具



BMC & COLOR SLEEVE

4 PCS
FOR / DLA VAG.

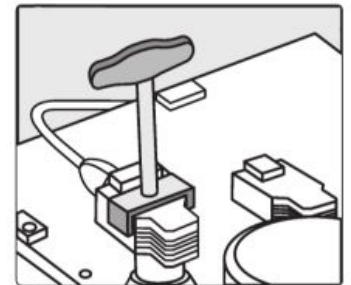

for / dla: VW, Audi, Skoda, Seat

YATO			
YT-06205	T type 1		Volkswagen FSI Golf / Bora 1998, Polo 2002, Touran 2004, New Beetle 2003, Passat 1997, T4+Audi A2 2001
	T type 2		Silniki/engines 6 cyl. 24V, 5 cyl, Golf / Bora 1998, Passat / Touareg 1997, Sharan 1996, Phaeton / Toureg 6 cyl. 2003, T5 z 6 cyl. silnikiem 2004
	T type 3		Volkswagen silnik / engines 2.0 z bezp. wtrysk / direct injection, Touran 2004, Passat 2006, Audi z bezp.wtrysk / direct injection A3 2.0 2004, A6 3.2 2005
	T type 4		Volkswagen z bezp. wtrysk / direct injection 2.0, Golf / Touran 2004, Passat 2006, Audi z bezp. wtrysk / direct injection, A3 2.0 2004, A6 3.2 2005

- GB Spark plug terminal pliers
- D Zange für das Zündkerzenkabel
- PL Szczypce do przewodów świec zapłonowych
- RUS Щипцы к проводам свечей зажигания
- CZ Kleště na kabely zapalovacích svíček
- H Gyújtógyertya-kábel fogó

- RO Clește pt. conductele bujiilor de aprindere
- F Pince pour fils d'allumage
- I Pinze per candele
- E Pinzas para los cables de las bujías de ignición
- CN 火花塞高压线钳

SLIDING CARD



YATO
YT-7320 L (mm) 255 10/60

- GB Multi-purpose hose & wire pliers
D Zangensatz für Schellen und Leitungen
PL Komplet szczypiec do opasek i przewodów
RUS Набор щипцов к хомутам и проводам
CZ Souprava kleští na spony a hadice
H Fogókészlet bilincsekhez és vezetékekhez
RO Set clește pt. benzi și conducte
F Pince pour collier de serrage
I Set pinze per il morsetto
E Juego de pinzas para abrazaderas y cables
CN 多功能管夹钳



2
PCS
1/4"-3/4"
6.3-19.0
mm
217
mm
254
mm

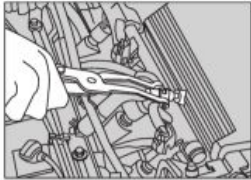

For engine air pipe
Do przewodów powietrznych listwy wtryskowej

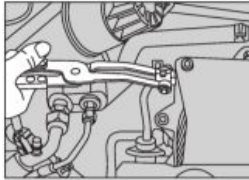

For engine intake air pipe
Do przewodów gumowych układu zasilania

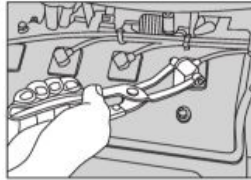

For spark plug lead
Do przewodów zapłonowych

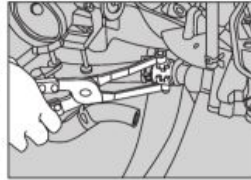

For cooling water pipe
Do przewodów gumowych układu chłodzenia



YATO	L (mm)	
YT-0645	217	6/24
	254	

- GB Hose clamp pliers
D Zange zum Entspannen der Klemmschellen
PL Szczypce do opasek zaciskowych rozprężnych
RUS Щипцы к хомутам зажимным распорным
CZ Kleště na samosvorné hadicové spony
H Vízcsőbilincs fogó
RO Clește pt. benzile de strângere destindere
F Pince pour collier de serrage
I Set pinze per il morsetto
E Pinzas para las abrazaderas de expansión
CN 管夹钳

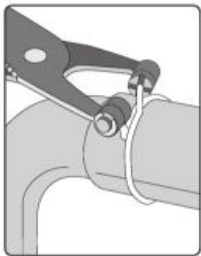

215
mm
+SLOT
2mm
LOCK
SYSTEM
SYSTEM
BLOKADY
ALLOY
STEEL
AISI 4130



YATO	L (mm)	
YT-0646	215	12/72

- GB Hose clamp pliers
D Zange zum Entspannen der Klemmschellen
PL Szczypce do opasek zaciskowych rozprężnych
RUS Щипцы к хомутам зажимным распорным
CZ Kleště na samosvorné hadicové spony
H Vízcsőbilincs fogó
RO Clește pt. benzile de strângere destindere
F Pince pour collier de serrage
I Set pinze per il morsetto
E Pinzas para las abrazaderas de expansión
CN 管夹钳



215
mm
V SLOT
4.5mm
LOCK
SYSTEM
SYSTEM
BLOKADY
ALLOY
STEEL
AISI 4130



YATO	L (mm)	
YT-0647	215	12/72

- GB Hose clamp pliers
D Zange zum Entspannen der Klemmschellen
PL Szczypce do opasek zaciskowych rozprężnych
RUS Щипцы к хомутам зажимным распорным
CZ Kleště na samosvorné hadicové spony
H Vízcsőbilincs fogó
RO Clește pt. benzile de strângere destindere
F Pince pour collier de serrage
I Set pinze per il morsetto
E Pinzas para las abrazaderas de expansión
CN 管夹钳

SLIDING
CARD



4mm
∅ 12mm
LOCK
SYSTEM
SYSTEM
BLOKADY
HRC
40

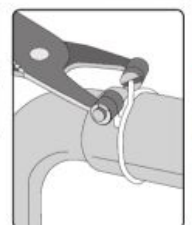

230
mm



215
mm

YATO	L (mm)	
YT-0650	230	6/36

YATO	L (mm)	
YT-0651	215	6/36

GB Exhaust pipe clamp pliers
 D Auspuffschellen-Sicherungszange
 PL Szczypce do opasek wydechu
 RUS Щипцы для пружинных зажимов
 CZ Kleště na spony výfuku
 H Kipufogóbilincs fogó

RO Clește pt. coliere teava de esapament
 F Pince pour collier d'échappement
 I Set pinze per il morsetto
 E Pinzas para bridas del tubo de escape
 CN 排气管夹钳

SLIDING CARD



300 mm

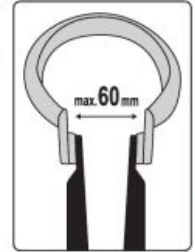

for / dla: Peugeot, Citroën, Renault, Fiat, Ford

YATO	L (mm)	
YT-0652	300	10/20

GB Valve stem seal pliers
 D Lange Zange für Ventildichtringe
 PL Szczypce do uszczelniaaczy zaworowych, długie
 RUS Щипцы для замены маслосъемных колпачков
 CZ Kleště na těsnění ventilů, dlouhé
 H Szelepszár szimering fogó hosszú

RO Clește cu picior lung pt. sigilat supape
 F Pince pour joints de queues de soupapes
 I Pinza per tenuta anello stelo valvola
 E Pinzas para juntas de vástagó válvula
 CN 气门油封钳

SLIDING CARD



270 mm

FOR VALVE STEM SEALS
 DO WSTĄCZNIACZY ZAWOROWYCH



NON-SLIP



YATO	L (mm)	
YT-0648	270	12/60

GB Pliers for band clips with a cord
 D Zange für Rohrschellen mit Seil
 PL Szczypce z linką do opasek zaciskowych
 RUS Щипцы к зажимным хомутам с тросиком
 CZ Kleště s lankem na samosvorné hadicové spony
 H Flexibilis bowdenes vízcsőbilincs fogó
 RO Clește pt. cleme de prindere frânghie
 F Pince pour collier de serrage
 I Pinza per il montaggio e lo smontaggio delle clips elastiche
 E Pinzas para bandas de apretadura con cuerda
 CN 延长型弹性管夹钳

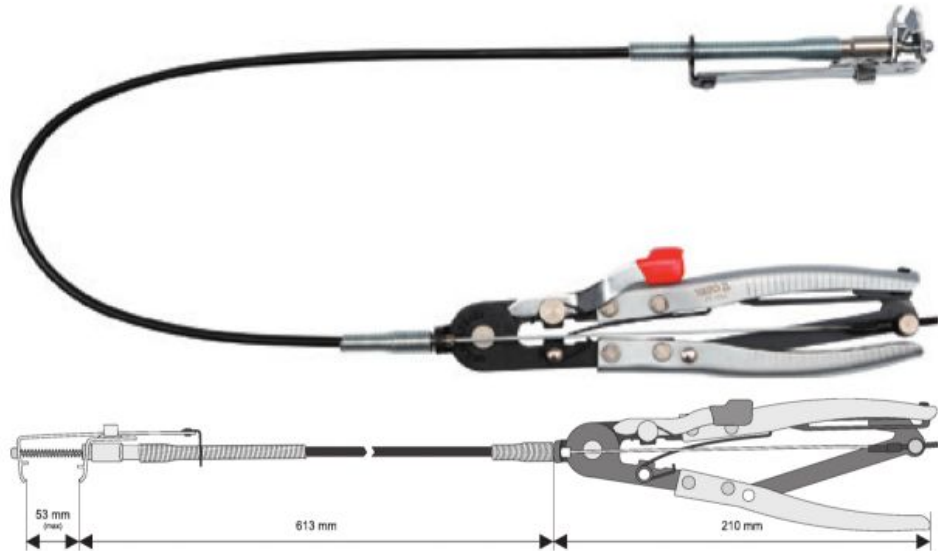

CrMo 4140

SLIDING CARD



YATO		
YT-0653		12/36

GB Pliers for band clips with a cord
 D Zange für Rohrschellen mit Seil
 PL Szczypce z linką do opasek zaciskowych
 RUS Щипцы к зажимным хомутам с тросиком
 CZ Kleště s lankem na samosvorné hadicové spony
 H Flexibilis bowdenes vízcsőbilincs fogó
 RO Clește pt. cleme de prindere frânghie
 F Pince pour collier de serrage
 I Pinza per il montaggio e lo smontaggio delle clips elastiche
 E Pinzas para bandas de apretadura con cuerda
 CN 延长型弹性管夹钳

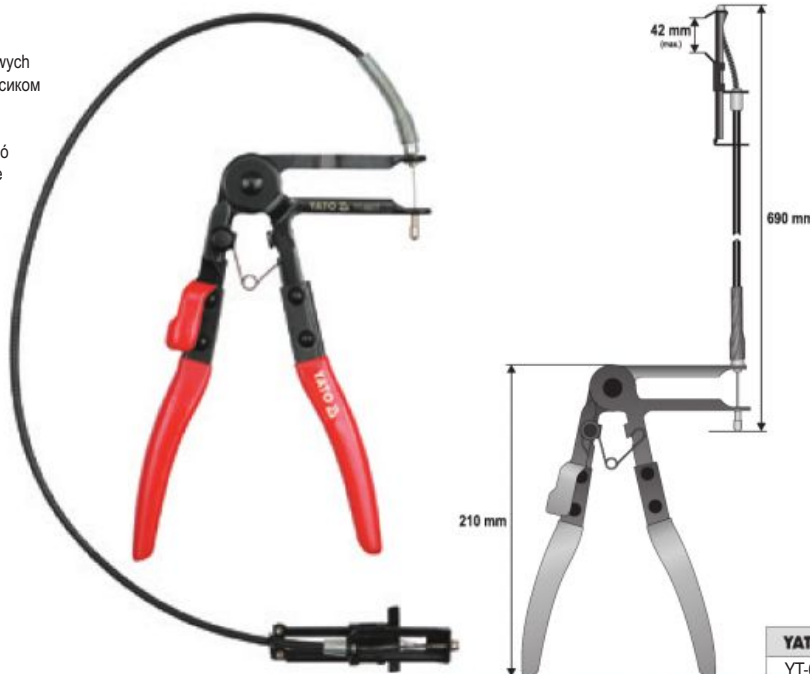

CrMo 4140

SLIDING CARD



YATO		
YT-0677		25

- GB Hose clip pliers
D Schlauchklemmzange
PL Szczypce do opasek zaciskowych typu CLIC i CLIC-R
RUS Плоскогубцы для зажима шлангов хомуты, CLIC-R
CZ Kleště na hadicové spony
H Tömöbilincs fogó
RO Cleste furtun clip
F Pince pour collier de serrage
I Pinza per fascetta a CLIC e CLIC-R
E Alicates abrazaderas
CN 压线钳



170 mm
CLIC
CLIC-R

SLIDING CARD



YATO	L (mm)	
YT-06475	170	15/60

- GB Water pump pulley locking wrench
D Schlüssel für die Wasserpumpe
PL Klucz do pompy wodnej
RUS Ключ к водному насосу
- CZ Klič na vodní čerpadlo
H Vízpumpafogó
RO Cheie pt. pompe de apă
F Clé de blocage pour pompe à eau
- I Chiave per la pompa del acqua
E Llave para la bomba de agua
CN 水泵皮带轮扳手

285 mm
30.5 mm
60 mm

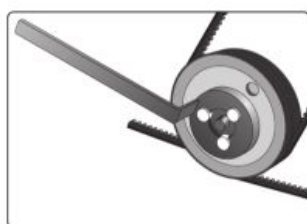

Volkswagen and Audi with air condition
Volkswagen i Audi z klimatyzacją

SLIDING CARD



YATO	L (mm)	
YT-0540	285	6/36

- GB Tensioner pulley wrench
D Zahnriemen Spannrollenschlüssel
PL Klucz do rolki napinającej
RUS Ключ для регулировки натяжного
CZ Klič na napínák
H Bordás szij feszítő
RO Cheie de pretensionare a centurilor
F Clé pour rouleau de tension
I Chiave per il rullo tenditore
E Llave del tensor de la correa dentada
CN 滑轮定时扳手



SLIDING CARD



32 mm

YATO		
YT-06273		20/100

- GB Universal pulley holder & fan clutch set
D Schlüssel zum Spannen der Riemenscheibe
PL Klucz do napinania koła pasowego
RUS Ключ для натягивания шкива
CZ Klič k napínání řemenice
- H Szíjtárcsa feszítő kulcs
RO Cheie pt. întindere roată de curea
F Clé universelle pour poulie
I Blocca puleggia
E Llave tensora para polea
CN 多用式皮带轮扳手



11 PCS

BMC & COLOR SLEEVE

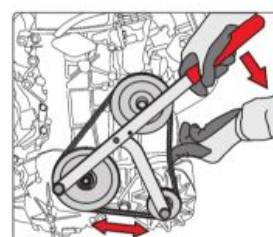

Ø 6-10 mm; Ø 8-11 mm;
Ø 10-12 mm; Ø 11-16 mm

YATO		
YT-0627		8

- GB Piston ring compressor
D Kolbenring-Spannband
PL Zaciskacz do pierścieni
RUS Оправка поршневых колец
CZ Svěrka na kroužky
H Gyűrűbepattintó
RO Clește pt. strâns inele
F Compresseur de segments de piston
I Morsetto per anelli
E Apretador de anillos
CN 活塞环压缩机



AISI # 301 SK5

COLOR BOX



YATO	Ø (mm)	H (mm)	
YT-0635	50-125	75	30/60
YT-0636	90-175	100	30/60
YT-0637	90-175	150	20/40

GB Cylinder honing machine
 D Zieh Schleifmaschine für Motorenzylinder
 PL Honownica do cylindrów
 RUS Хонинговальный станок

CZ Valcový honovací stroj
 H Henger hónoló
 RO Mașină de honuit cilindri
 F Machine à roder des cylindres

I Levigatrice per cilindri
 E Máquina herramienta para afilar los cilindros
 CN 气缸打磨器

SLIDING CARD

x3 HONES KAMENIE
HONING TENSION REGULOVANÝ NACISK
FLEXIBLE SHAFT ELASTYCZNY WALEK



Ø 19-63 mm
 205 mm
 28x6 mm HONE SIZE

Ø 32-89 mm
 230 mm
 51x7 mm HONE SIZE

Ø 51-177 mm
 305 mm
 76x10 mm HONE SIZE

YATO	Ø L (mm)	L (mm)	
YT-05810	19-63	205	50/100

YATO	Ø L (mm)	L (mm)	
YT-05811	32-89	230	50/100

YATO	Ø L (mm)	L (mm)	
YT-05812	51-177	305	5/20

GB Interchangeable stones for honing machine
 D Wechselschleifsteine für die Zieh Schleifmaschine
 PL Kamienie wymienne do honownicy
 RUS Сменный брусок для хонинговального станка

CZ Výměnné kameny do honovacího stroje
 H Cserélhető kövek a hónolóhoz
 RO Pietre intersanjabile pt. mașina de honuit
 F Pierres Interchangeable de la machine à roder

I Set di pietre di ricambio per levigatrice
 E Piedras intercambiables a la máquina herramienta para afilar cilindros
 CN 磨石

SLIDING CARD

3 PCS

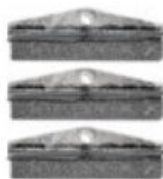

28x6 mm HONE SIZE
 for / dla: YT-05810

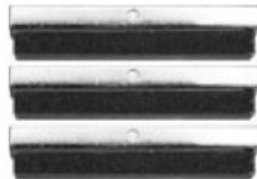

51x7 mm HONE SIZE
 for / dla: YT-05811

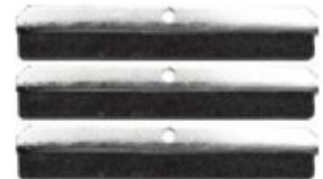

76x10 mm HONE SIZE
 for / dla: YT-05812

YATO	
YT-05815	50/200

YATO	
YT-05816	50/200

YATO	
YT-05817	50/100

GB Belt gauge
 D Werkzeug Spannungsprüfer
 PL Przyrząd do kontroli napięgu paska rozrządu
 RUS Прибор для проверки натяжения ремней
 CZ Přípravek pro kontrolu napnutí rozvodového řemene
 H Méter szíjfeszességét
 RO Tester întindere curea de distributie cu gradatie
 F Controleur de tension de courroie
 I Strumento per il controllo rapido della tensione cinghia distribuzione
 E Medidor para determinar la tensión de la correa
 CN 皮带张紧器

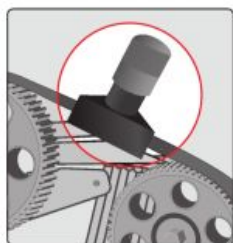

COLOR BOX



YATO	
YT-06019	20

GB Special socket antechamber injection pump
 D Kerbzahn-Einsatz Für Vorkammer-Muttern an Dieselmotoren
 PL Nasadka do komory wstępnej wirowej
 RUS Сервисный ключ для форкамер
 CZ Klíč pro vstřikovací čerpadla
 H Dugókulcs befecskendező szivattyúhoz
 RO Tubulara speciala pt. anticamera pompa de injectie motoare
 F Douille spéciale pipe d'admission
 I Bussola per precamera
 E Llave de vaso con dentado exterior para cámara de precombustión
 CN 奔驰火花塞外齿套筒



1/2"
 12.5mm
 Ø 28 mm
 FOR MERCEDES DO MERCEDESA

PLASTIC HANGER



YATO	
YT-12005	15/60

GB Twin cam locking tool for petrol & diesel engines
D Universelle Blockade der Steuerwellen
PL Uniwersalna blokada wałków rozrządu
RUS Универсальный набор блокировки распределительных механизмов
CZ Univerzální přípravek na zablokování rozvodných hřídelí
H Univerzális vezérműtengely rögzítő

RO Blocadă universală arbore de direcție
F Outil de blocage d'arbre à cames
I Universale strumento di bloccaggio a camme
E Bloqueo universal de eje de distribución
CN 双凸齿轮固定器

FOR PETROL & DIESEL ENGINES
DO SILNIKÓW DIESLA I BENZYNOWYCH

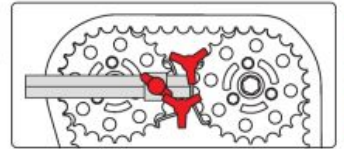

SLIDING CARD

YATO	
YT-06011	10/20

GB Camshaft locking tool
D Nockenwellen-Arretierwerkzeug
PL Przyrząd do blokowania kół rozrządu
RUS Инструмент для блокирования распределительных механизмов
CZ Přípravek k montáži rozvodových kol
H Vezérlés rögzítő szerszám
RO Arbore cu came
F Outil de blocage d'arbre à cames
I Set di serrature di temporizzazione
E Aparato para bloquear el árbol de levas
CN 正时皮带固定器

SLIDING CARD



48 mm

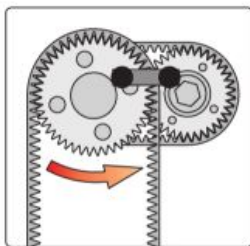

VW Lupo since 1999
VW Polo since 1995
VW Caddy since 1996
VW Polo Classic since 1996
VW Polo Variant since 1996
VW New Beetle 1.4 I
VW Golf 1.4 I, 1.6 I since 1998
VW Bora 1.4 I, 1.6 I since 1999

YATO	
YT-0601	6/36

GB Diesel engine locking setting kit
D Blockade für die Steuerräder
PL Blokada do kół rozrządu
RUS Блокировка к колесам распределительных механизмов
CZ Souprava na fixaci rozvodových kol
H Diesel motor rögzítő készlet

RO Blocadă roților distribuție
F Outil de blocage d'arbre à cames
I Cinghia di distribuzione di bloccaggio
E Bloqueo para las poleas del mecanismo de distribución
CN 正时皮带更换工具

3 PCS

FOR VALVETRAIN DO URZADU ROZRZADU

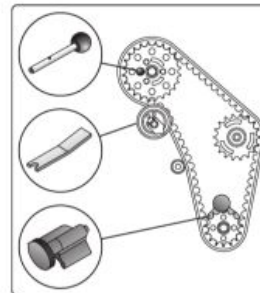

SLIDING CARD

VW: Lupo, Polo, Golf / Bora, Beetle, Caddy, Sharan, Touran, Transporter (1998-2006);
AUDI: A2, A3, A4, A6;
FORD: Galaxy (2000-2006);

SEAT: Arosa, Ibiza, Cordoba, Leon, Toledo, Alhambra (1999-2005);
SKODA: Fabia, Octavia (2000-2006)
3 i 4 cyl 1.2, 1.4, 1.9 TDI PD
2.0 SDI, 2.0 TDI PD

YATO	
YT-0632	10/50

GB Timing locking set
D Arretierwerkzeugsatz für Nockenwellen
PL Zestaw blokad rozrządu
RUS Набор блокировок к колесам распределительных механизмов
CZ Blokovací sada pro opravy rozvodů
H Vezérműrögzítő szerszámkészlet
RO Set blocare distributie auto
F Outil de blocage d'arbre à cames
I Set di bloccaggio distribuzione auto
E Juego de bloques de distribución
CN 正时皮带固定器组套



3 PCS

FOR VALVETRAIN DO URZADU ROZRZADU

FOR DIESEL ENGINES DO SILNIKÓW DIESLA

FOR GASOLINE ENGINES DO SILNIKÓW BENCZYNOWYCH

APPLICATION:
RENAULT: Twingo, Clio, Kangoo, Megane, Scenic, Laguna, Espace 1.2, 1.4, 1.6, 1.8, 2.0 16v (98-06), 1.5dCi;
NISSAN: Micra 1.5dCi, Kubistar 1.6 16v (03-06); OPEL: Vivaro 2.0 16v (01-06)

ZASTOSOWANIE:
RENAULT: Twingo, Clio, Kangoo, Megane, Scenic, Laguna, Espace 1.2, 1.4, 1.6, 1.8, 2.0 16v (98-06), 1.5dCi;
NISSAN: Micra 1.5dCi, Kubistar 1.6 16v (03-06); OPEL: Vivaro 2.0 16v (01-06)

ENGINE CODES:
RENAULT: D4F, K4J, K4M, F4P F4R, F4Rt, F5R740, K9K;
NISSAN: K9K, K4M; OPEL: FR4 720

SILNIKI O KODZIE:
RENAULT: D4F, K4J, K4M, F4P F4R, F4Rt, F5R740, K9K;
NISSAN: K9K, K4M; OPEL: FR4 720

YATO	
YT-06014	10



GB Timing locking set
 D Arretierwerkzeugsatz für Nockenwellen
 PL Zestaw blokad rozrządu
 РУS Набор блокировок к колесам распределительных механизмов

CZ Blokovací sada pro opravy rozvodů
 H Vezérműrogzítő szerszámkészlet
 RO Set blocare distributie auto
 F Outil de blocage d'arbre à cames

I Set di bloccaggio distribuzione auto
 E Juego de bloques de distribución
 CN 正时皮带固定器组套

4
PCS
 FOR VALVETRAIN DO UKŁADU ROZRZĄDU
 FOR GASOLINE ENGINES DO SILNIKÓW BENZYNOWYCH
DROP FORGED KUTE

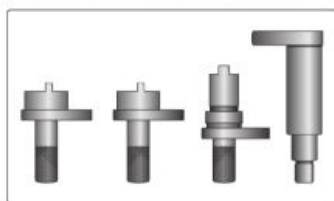
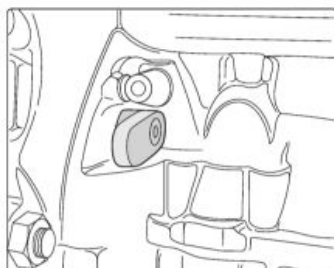
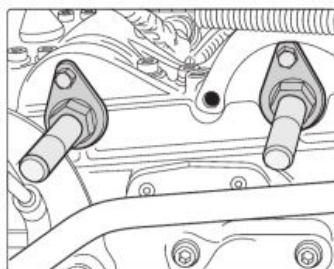

Timing locking set for engines 1.2 6V / 12V (chain) Zestaw blokad rozrządu silników 1.2 6V / 12V (łańcuch)

APPLICATION:
VW, SKODA, SEAT 1.2 12V and 1.2 6V (HTP);
 VW: Polo;
 SEAT: Ibiza, Cordoba;
SKODA: Fabia HTP;
 Engine codes AZQ, AWY, BMD, BME (02-07).

ZASTOSOWANIE:
VW, SKODA, SEAT 1.2 12V i 1.2 6V (HTP);
 VW: Polo;
 SEAT: Ibiza, Cordoba;
SKODA: Fabia HTP;
 Silniki o kodzie AZQ, AWY, BMD, BME (02-07).

SET INCLUDES:
 • camshaft locking pin 1 pc
 • crankshaft locking pin 1 pc
 • camshaft locking clamps 2 pcs

ZESTAW ZAWIERA:
 • trzpień blokujący wałek rozrządu 1 szt.
 • trzpień blokujący wał korbowy 1 szt.
 • zacisk blokujący walki rozrządu 2 szt.



YATO
 YT-06012 10

GB Timing locking set
 D Arretierwerkzeugsatz für Nockenwellen
 PL Zestaw blokad rozrządu
 РУS Набор блокировок к колесам распределительных механизмов
 CZ Blokovací sada pro opravy rozvodů
 H Vezérműrogzítő szerszámkészlet
 RO Set blocare distributie auto
 F Outil de blocage d'arbre à cames
 I Set di bloccaggio distribuzione auto
 E Juego de bloques de distribución
 CN 正时皮带固定器组套

APPLICATION / ZASTOSOWANIE:
 FIAT: 500, Panda, Punto, Grande Punto, Albea, Linea, Bravo, Brava, Palio, Idea, Weekend, Siena, Stilo, Marea (97-10);
 LANCIA: Ypsilon, Musa (96-10)
ENGINE CODES / SILNIKI O KODZIE:
 1.2 16V - 176B9.000, 182B2.000, 188A5.000,
 1.4 16V - 843A1.000, 169A3.000, 192B2.000,
 198A1.000, 198A4.000, 199A6.000



5
PCS
 FOR VALVETRAIN DO UKŁADU ROZRZĄDU
 FOR GASOLINE ENGINES DO SILNIKÓW BENZYNOWYCH

BMC & COLOR SLEEVE



YATO
 YT-06016 10

GB Timing locking set
 D Arretierwerkzeugsatz für Nockenwellen
 PL Zestaw blokad rozrządu
 РУS Набор блокировок к колесам распределительных механизмов
 CZ Blokovací sada pro opravy rozvodů
 H Vezérműrogzítő szerszámkészlet
 RO Set blocare distributie auto
 F Outil de blocage d'arbre à cames
 I Set di bloccaggio distribuzione auto
 E Juego de bloques de distribución
 CN 正时皮带固定器组套

APPLICATION / ZASTOSOWANIE:
 OPEL: Astra, Vectra, Signum, Zafira, 1.9 CDTi (04 - 06);
 FIAT: 1.9, 2.4 JTD; 16v, 20v;
 ALFA ROMEO: 147, 156, GT 1.9 JTD 16v, 2.4 JTD 20v
ENGINE CODES / SILNIKI O KODZIE:
 OPEL: Z19DTH, Z19DT;
 ALFA ROMEO: 192 A5.000, 192 B1.000, 937 A4.000, 937 A5.000



6
PCS
 FOR VALVETRAIN DO UKŁADU ROZRZĄDU
 FOR DIESEL ENGINES DO SILNIKÓW DIELA

BMC & COLOR SLEEVE



YATO
 YT-06013 10

- GB Timing locking set
D Arretierwerkzeugsatz für Nockenwellen
PL Zestaw blokad rozrządu
RUS Набор блокировок к колесам распределительных механизмов
CZ Blokovací sada pro opravy rozvodů
H Vezérműrgyítő szerszámkészlet
RO Set blocare distributie auto
F Outil de blocage d'arbre à cames
I Set di bloccaggio distribuzione auto
E Juego de bloques de distribución
CN 正时皮带固定器组套



6
PCS

1/2"
12.5mm

FOR VALVE TRAIN
DO UKŁADU ROZRZĄDU

FOR BMW
ENIGEL ENGINE
DO SILNIKÓW
DIESELA BMW



APPLICATION / ZASTOSOWANIE:
BMW: Serie 1 (E81; E82; E87; E88; F20)
Serie 3 (E90; E91; E92; E93; F30)
Serie 5 (E60; E61; F10; F11)
X1 (E84) X3 (E83, F25)
2.0 N47, N47S (2007-2010)

YATO
YT-06018 10

- GB Timing locking set
D Arretierwerkzeugsatz für Nockenwellen
PL Zestaw blokad rozrządu
RUS Набор блокировок к колесам распределительных механизмов
CZ Blokovací sada pro opravy rozvodů
H Vezérműrgyítő szerszámkészlet
RO Set blocare distributie auto
F Outil de blocage d'arbre à cames
I Set di bloccaggio distribuzione auto
E Juego de bloques de distribución
CN 正时皮带固定器组套



7
PCS

FOR VALVE TRAIN
DO UKŁADU ROZRZĄDU

FOR GASOLINE
ENGINES
DO SILNIKÓW
BENZYNOWYCH



APPLICATION / ZASTOSOWANIE:
OPEL: Adam, Ampera, Astra-J, Corsa-D,
Meriva-B, Mokka, Zafira-C Tourer; CHEVROLET Aveo
ENGINE CODES / SILNIKI O KODZIE:
1.0 A10 XEP, 1.2 A12 XEL, 1.2 A12 XER, 1.4 A14 XFL, 1.4 A14 XEL,
1.4 A14 XER, 1.4 A14 NEL, 1.4 A14 NET

YATO
YT-06009 5

- GB Timing locking set
D Arretierwerkzeugsatz für Nockenwellen
PL Zestaw blokad rozrządu
RUS Набор блокировок к колесам распределительных механизмов
CZ Blokovací sada pro opravy rozvodů
H Vezérműrgyítő szerszámkészlet
RO Set blocare distributie auto
F Outil de blocage d'arbre à cames
I Set di bloccaggio distribuzione auto
E Juego de bloques de distribución
CN 正时皮带固定器组套



7
PCS

FOR VALVE TRAIN
DO UKŁADU ROZRZĄDU

FOR GASOLINE
ENGINES
DO SILNIKÓW
BENZYNOWYCH



APPLICATION / ZASTOSOWANIE:
OPEL: ASTRA G,H, CORSA D,
MERIVA (06-08), VECTRA (06-08),
SIGNUM (06-08), ZAFIRA (03-08);
CHEVROLET: CRUZE, ORLANDO 1.4, 1.6, 1.8;
FIAT: CROMA;
ALFA ROMEO: 159
ENGINE CODES / SILNIKI O KODZIE:
OPEL: 1.6-Z16LEL, Z16LER, Z16LET, Z16XE, Z16XER, 1.8-Z18XER
CHEVROLET; FIAT; ALFA ROMEO: 939A4.000

YATO
YT-06005 10

- GB Timing locking set
- D Arretierwerkzeugsatz für Nockenwellen
- PL Zestaw blokad rozrządu
- RUS Набор блокировок к колесам распределительных механизмов
- CZ Blokovací sada pro opravu rozvodů
- H Vezérműrogzítő szerszámkészlet
- RO Set blocare distributie auto
- F Outil de blocage d'arbre à cames
- I Set di bloccaggio distribuzione auto
- E Juego de bloques de distribución
- CN 正时皮带固定器组套



8
PCS
AI

BMC
& COLOR
SLEEVE

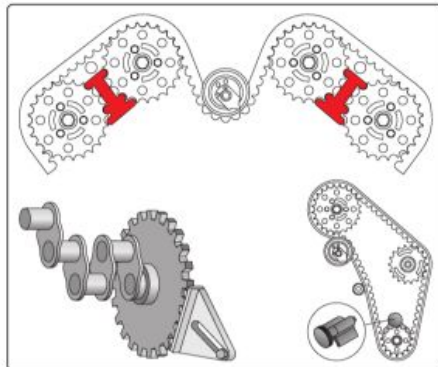

YATO	No.	No.	
YT-0633		Vauxhall/Opel: ASTRA G 1.7 TD, ASTRA G 2.0 16V, VECTRA 1.8/2.0 16V > 1995	
		Vauxhall/Opel: ASTRA G 1.4/1.6/1.8 16V > 1994, VECTRA 1.6/1.8 16V, ZAFIRA 1.6/1.8 16V	
		right hand camshaft Saab: 900-9000 Vauxhall/Opel: CALIBRA 2.5/2.6 V6, CAVALIER 2.5i V6, OMEGA B 2.5/2.6/3.0/3.2 V6, SINTRA 3.0 V6, VECTRA A 2.5/2.6 V6	
		left hand camshaft Saab: 900-9000 Vauxhall/Opel: CALIBRA 2.5/2.6 V6, CAVALIER 2.5i V6, OMEGA B 2.5/2.6/3.0/3.2 V6, SINTRA 3.0 V6, VECTRA A 2.5/2.6 V6	
		Rover: 25 1.4/1.6/1.8/VVC, 45 1.4/1.6/1.8, 75 1.8, 200 Vi, 214 16V, 216 16V/CABRIO/COUPE, 218 COUPE, 414 16V, 416 16V, BRM 1.8VVC	
			Volkswagen: BORA 1.9TDI, GOLF 1.9TDI, LUPO 1.2/1.4/3.0 TDI, POLO 1.4TDI PASSAT 1.9TDI Citroen: BERLINGO 1.9D, DISPATCH 1.9D/TD-FSO 1.9D, RELAY 1.9D/TD, SYNERGIE 1.9/2.0T, SANTIA 1.9/2.0 D/TD/HDI, XSARA 1.9/2.0 D/HDI, ZX 1.9D/TD, most diesels Fiat: DUCATO 2.0D, ULYSSE 1.8/2.0 TURBO Ford: most diesels Peugeot: 205 1.6/1.8/1.9D, 305 1.6/1.8/1.9D, 306 1.8/1.9D/TD, 309 1.6/1.9D-4.5 1.6/1.9D, 406 1.9D, 605 2.0D/TD, 806 1.9TD, BOXER 1.9/2.0 D/TD, EXPERT 1.9D, PARTNER 1.9D Talbot: EXPRESS D, HORIZON D-J5 D, SOLARA D Isuzu: 1.5/1.7 diesel engines Vauxhall/Opel: 1.6/1.7 diesel engines, 1.2/1.4/1.6/1.8/2.0 OHC petrol engines

- GB Timing locking set for V.A.G.
- D Einstellwerkzeug Zahnriemen nockenwellen Arretierwerkzeug steuerriemen für V.A.G.
- PL Zestaw blokad rozrządu dla V.A.G.
- RUS Набор блокировок газораспределения V.A.G.

- CZ Sada aretacie rozvodov pro V.A.G.
- H Vezérműrogzítő készlet, V.A.G. - hoz
- RO Set blocare distributie auto pt. V.A.G.
- F Outil de blocage d'arbre à cames

- I Set di bloccaggio distribuzione auto
- E Juego de bloques de distribución para V.A.G.
- CN 大众&奥迪正时工具

34
PCS
FOR / DLA
V.A.G.

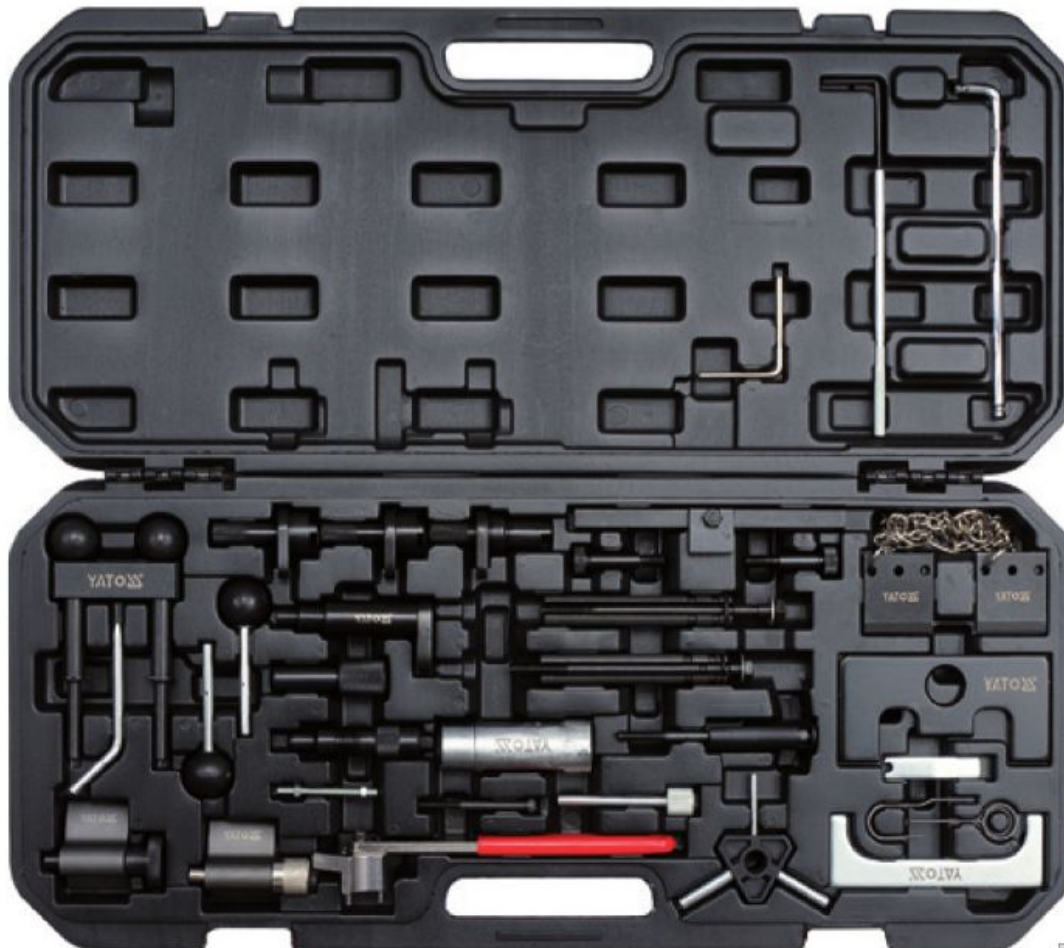

BMC
& COLOR
SLEEVE



YATO	YT-06015	4
------	----------	---

- GB** Timing locking set for V.A.G.
D Einstellwerkzeug Zahnriemen nockenwellen
Arretierwerkzeug steuerriemen für V.A.G.
PL Zestaw blokad rozrządu dla V.A.G.
RUS Набор блокировок газораспределения V.A.G.
CZ Sada aretacie rozvodov pro V.A.G.
H Vezérműrogzító készlet, V.A.G. - hoz
RO Set blocare distributie auto pt. V.A.G.
F Outil de blocage d'arbre à cames
I Set di bloccaggio distribuzione auto
E Juego de bloqueos de distribución para V.A.G.
CN 大众&奥迪正时工具

APPLICATION / ZASTOSOWANIE:

AUDI: A3 (03-10); SEAT: Altea, Ibiza, Leon; **SKODA**: Fabia II (07-09), Octavia (04-09), Roomster (06-09), Superb (09-10); VW: Eos (06-09), Golf (03-09), Golf Plus (05-09), Jetta (06-09), Passat (05-09), Polo (02-08), Scirocco (09-10), Tiguan (07-09), Touran (03-09)

ENGINE CODES / SILNIKI:

1.4 FSI: (AXU, BKG, BLN)
1.4 TFSI: (BLG, BMY, BWK, CAVA, CAVB, CAVC, CAVD, CAVF, CAXA, CAXC, CDGA)
1.6 FSI: (BAG, BLF, BLP, BTS)



4
PCS
FOR VALVE TRAIN
DO UKŁADU
ROZRZĄDU
FOR GASOLINE
ENGINES
DO SILNIKÓW
BENZYNOWYCH

BMC
& COLOR
SLEEVE



YATO
YT-06017 10

- GB** Wire brush set
D Bürsten Sortiment
PL Zestaw szczotek do gniazd wtryskiwaczy
RUS Ерши с наружной резьбой в наборе
CZ Rournové kartáče válcové
H Henger drótkefe
RO Perii cilindrice pt. curatarea gaurilor
F Brosse cylindrique
I Vetro di protezione
E Cepillos para limpieza interior
CN 件套清洁组



20 PCS
150 mm
1/4" 6.3mm
9,11,13
15,17,19
mm
NYLON
SS
BRASS
STAINLESS STEEL
ENH. METALWORK
MOSIADZ



NYLON CASE
& COLOR BOX

YATO
YT-08195 24

- GB** Diesel injector puller
D Stoßabziehvorrichtung für Einspritzdüse
PL Ściągacz bezwładnościowy do wtryskiwaczy
RUS Ударный съемник форсунок
CZ Rázový vytahovač vstříkovačů
H Diesel porlasztó kieszedő
RO Dispozitiv de scos injectoare
F Extracteur à choc d'injecteurs
I Martello scorrevole per la rimozione degli iniettori
E Tuerca tensora de impacto para inyectores
CN 柴油喷嘴拔取器



FOR INJECTORS
DO WTRYSKIWACZY

BOSCH
TYPE

LUCAS
TYPE

M8
M12
M14



BMC
& COLOR
SLEEVE



YATO
YT-0617 20

- GB** Injector puller set CDI
D Diesel-Injektoren-Auszieher-Satz CDI
PL Ściągacz do wtrysków CDI
RUS Съемник дизельных форсунок CDI
CZ Vytahovač vstříkovačů s úderovým kladivem CDIů
H Porlasztó kihúzó készlet csúszó kalapáccsal CDI motorhoz
RO Set extractor pt. injectoare cu ciocan inertial pt. motoare CDI
F Coffret extracteur d'injecteur diesel CDI
I Estrattore iniettori per Mercedes CDI
E Juego 8 piezas de extracción de inyectores en CDI
CN 8件套柴油喷嘴拆卸工具



FOR INJECTORS
DO WTRYSKIWACZY

8
PCS



BMC
& COLOR
SLEEVE



YATO
YT-06176 5

APPLICATION / ZASTOSOWANIE:
MERCEDES CDI: OM611, OM612, OM613

- GB Diesel injector master removal kit
- D Injektor Auszieher Abzieher
Werkzeug Einspritzdüsen
- PL Zestaw ściągaczy
bezwładnościowych
do wtryskiwaczy
- RUS Съемник форсунок
с ударным молотком
для дизельных двигателей
- CZ Souprava na demontáž
vstřikovaču s reverzním klavdem
- H Injektor kihúzó készlet,
csúszókalapáccsal
- RO Set de extractoare inertiiale
pt. injectoare
- F Coffret extracteur d'injecteur
- I Set di estrattori ad inerzia
per iniettori
- E Extractor de inyectoros
de inyección
- CN 24件套柴油喷嘴维修工具



22 PCS	1/2" 12.5mm	BOSCH DELPHI DENSO SIEMENS
PUMP CUBE DIESEL INJECTORS	2 HAMMERS	2 MULTI



BMC

YATO	
YT-06175	1

- GB Universal extractor broken glow plugs
- D Glühkerze Entfernung Reparatur
- PL Zestaw do demontażu
urwanych świec żarowych
- RUS Набор инструментов для демонтажа
свечей накаливания
- CZ Přípravek pro odvrtání a opravu
závitu žhavicích svíček
- H Izzító gyertya menetjavítás bállítása
- RO Set extractor bujii reparare filet
- F Kit extracteur bougie de préchauffage
et réparation de filetage
- I Kit per l'estrazione delle candele rotte
- E Descripción de juego
reparación de rosca
- CN 热火塞螺纹修复工具组套



16 PCS	3/8" 10mm
CrV	HSS 4241

BMC
& COLOR
SLEEVE



YATO	
YT-05342	5

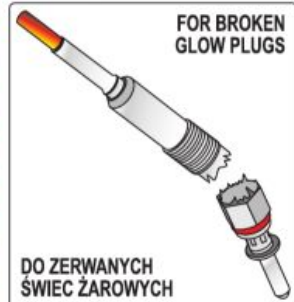

- GB Overhead valve spring compressor
- D Vorrichtung zur Demontage von Motorventilen
- PL Przyrząd do demontażu zaworów silnikowych
- RUS Устройство для демонтажа клапанов двигателя
- CZ Přípravek na demontáž ventilů motoru
- H Szeleplehúzó készülék
- RO Dispozitiv pt. demontarea supapelor la motoare
- F Outil pour démonter
les soupapes de moteur
- I Strumento per la rimozione
di valvole motore
- E Instrumento para desmontaje
de válvulas de motor
- CN 下压式凡尔钳



SLIDING
CARD

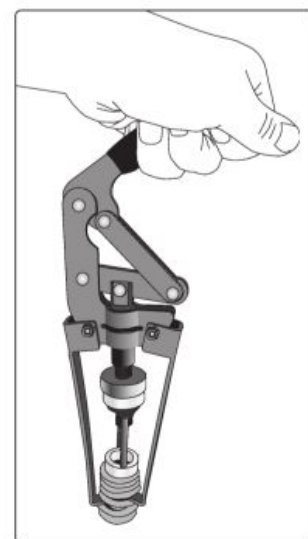

YATO	
YT-0618	5/25

- GB** Lambda sensor thread chaser
D Lambdasonde gewinde reparatur-set
PL Zestaw do naprawy gwintów sondy lambda
RUS Набор для ремонта сорванной резьбы винтов
CZ Sada na opravu závitů Lambda sondy
H Menetjavító készlet Lambda szondához
RO Dispozitiv pt. curatat filet sonda lambda
F Set de réparation filetage de sonde lambda
I Chiavi a bussola per sonda lambda
E Cazador del hilo de rosca para sonda lambda
CN 火星塞丝攻组套

FOR OXYGEN SENSOR DO SONDY LAMBDA

HRC 50

M12 x 1.25

M18 x 1.5



SLIDING CARD

YATO

YT-1756

12/96

- GB** Oxygen sensor crowfoot wrench
D Schlüssel für die Lambdasonde
PL Klucz do sondy lambda
RUS Ключ для зонда лямбда
CZ Klíč na sondu lambda
H Lambda szonda kulcs
RO Cheie pt. sonda lambda
F Clé pour sonde lambda
I Chiave per sonde lambda
E Llave para la sonda lambda
CN 氧传感器套筒扳手

SLIDING CARD

22 mm



FOR OXYGEN SENSOR DO SONDY LAMBDA



CrMo SCM-440

YATO

YT-1753

15/60



CrV 50BV30

YATO

YT-1754

6/36

- GB** Socket and oxygen sensor set
D Steckschlüssel für die Lambda-Sonde
PL Klucze nasadowe do sondy lambda
RUS Торцовые ключи с внутренним многогранником для зонда лямбда
CZ Nástrčné klíče na sondy lambda
H Dugókulcs lambda szondához
RO Prize pt. sonda lambda
F Douille pour sonde lambda
I Set di riparazione per filetti di sonde lambda
E Llaves de cubo para la sonda lambda
CN 氧传感器套筒扳手组套



22 mm; L= 50 mm; 6PT; CrMo SCM440;



22 mm; L=30 mm; 6PT; CrMo SCM440;



22 mm; L=80 mm; 6PT; CrV 50BV30



3 PCS

22 mm

FOR OXYGEN SENSOR DO SONDY LAMBDA

CrMo SCM-440

CrV 50BV30

BMC & COLOR SLEEVE



YATO

YT-1752

20

- GB** Oxygen sensor and fuel injectors wrench set
D Steckschlüsselsatz für die Lambdasonde und die Einspritzdüsen
PL Zestaw nasadek do sondy lambda i wtryskiwaczy
RUS Набор насадок к лямбда-зондам и форсункам
CZ Sada nástavců na demontáž sondy lambda a vstřikovačů
H Dugókészlet lambda szondákhoz és injektorokhoz
RO Set inelare pt. sonda lambda și injectoare
F Douilles pour sonde lambda et injecteurs
I Set di riparazione per filetti di sonde lambda
E Juego de boquillas para la sonda lambda y para inyectores
CN 氧传感器套筒扳手组套



7 PCS

1/2" 12.5mm

3/8" 10mm

CrMo SCM-440

CrV 50BV30

FOR OXYGEN SENSOR DO SONDY LAMBDA

FOR FUEL INJECTORS DO WTRYSKÓW PALIWA

1/2" (12.7 mm) x 29 mm; L=90 mm; 6PT;

3/8" (9.5 mm) x 22 mm; L=90 mm; 6PT;

1/2" (12.7 mm) x 27 mm; L=78 mm; 12PT;

3/8" (9.5 mm) x 27 mm; L=74 mm; 6PT;

3/8" (9.5 mm) x 22 mm; L=80 mm; 6PT;

1/2" (12.7 mm) x 22 mm; L=50 mm; 6PT;

3/8" (9.5 mm) x 22 mm; L=30 mm; 6PT;

BMC & COLOR SLEEVE



YATO

size / rozmiar

YT-1751

1/2" (12.7 mm)

3/8" (9.5 mm)

5

- GB Diesel injection socket set
- D Aufsätze für die Einspritzungen bei Dieselmotoren
- PL Zestaw nasadek do wtrysków w silnikach Diesla
- RUS Набор насадок к форсункам в дизельных двигателях
- CZ Sada nástavců na trysky dieselových motorů
- H Szerszámkészlet Dieselmotor befecskendezőkhöz
- RO Set de capete pt. injectoare in motoare Diesel
- F Set des douilles pour injecteurs (diesel)
- I Set di custodie per i motori diesel
- E Juego de tapones para las inyecciones en los motores de Diesel
- CN 柴油机加注套筒组套



6 PCS	1/2" 12.5mm
AS-DRIVE	CrV
FOR FUEL INJECTORS DO WTRYSKÓW PALIWA	



YATO	size / rozmiar	
YT-0622	1/2" (12.7 mm)	10

21x90; 22x78; 22x110; 27x78; 28x78; 28x83 mm

- GB Diesel injector and cutter set
- D Fräsersatz für die Buchsen der Einspritzdüsen
- PL Zestaw frezów do gniazd wtryskiwaczy common rail
- RUS Комплект фрез для гнезд сопел форсунки
- CZ Sada fréz na sedla trysek vstříkovačů
- H Marókészlet befecskendező fűvókájának fészkéhez
- RO Set de freze pt. socluri de duze injectoare
- F Alimentation d'un injecteur de common rail
- I Set frese per sedi iniettori common rail
- E Juego de fresas para el asiento de toberas de inyectoras
- CN 7件套气门铰刀



7 PCS
CrMoV SKD11

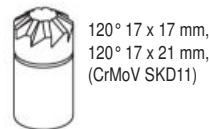
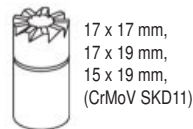
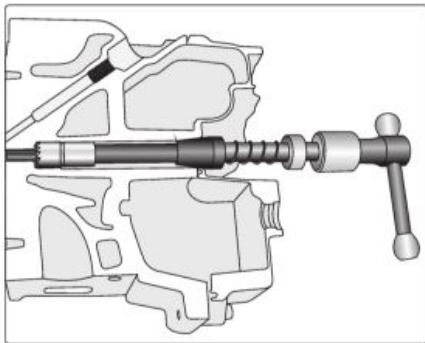

YATO	
YT-17625	10

16

- GB Tooth socket for injection nozzle
- D Stiftschlüsselsatz für die Einspritzdüse in Lastkraftwagen
- PL Zestaw kluczy czopowych do wtryskiwaczy w samochodach ciężarowych
- RUS Набор шиповых ключей к форсункам грузовых автомобилей
- CZ Sada klíčů na vstříkovače pro nákladní automobily
- H Csaposkulcs készlet tehergépkocsi befecskendezőjéhez
- RO Set chei tubulare cu ungere pt. camioane
- F Set de douilles injecteurs
- I Set di chiavi per iniettori camion
- E Juego de llaves de muñon para los inyectoras en camiones
- CN 卡车喷油嘴套筒组套



4 PCS	1/2" 12.5mm	HEX
CrMo	S45C	CrV
FOR FUEL INJECTORS DO WTRYSKÓW PALIWA		



YATO	size / rozmiar	
YT-1762	1/2" (12.7 mm)	16

- 1/2" (12.7 mm); L=72 mm; 4T; CrV;
- 32 mm; M14 x 1.5 mm; L=70 mm, 4T; S45C;
- 1/2" (12.7 mm); L=120 mm; 3T; CrMo;
- 32 mm; L=120 mm, 4T; S45C

- GB Fuel injection test kit
- D Diagnosesatz für die Prüfung der Kraftstoffeinspritzung
- PL Zestaw diagnostyczny do wtrysku paliwa
- RUS Пневматический набор к тормозным зажимам
- CZ Souprava k diagnostice vstřikování paliva
- H Diagnosztikai készlet üzemanyag - befecskendőzökhöz
- RO Ansamblu pt. diagnosticarea injectiei combustibilului
- F Kit de test de débit d'injecteur
- I Set diagnostico per iniettori la benzina
- E Juego de herramientas diagnosticas para la inyección de combustible
- CN 燃料注射测试组套



10
PCS

P max.
0.7 MPa

BMC
& COLOR
SLEEVE



YATO
YT-0670 10

- GB Compression pressure gauge in a diesel engine
- D Kompressionsdruckmesser in Dieselmotoren
- PL Miernik ciśnienia sprężania w silnikach diesla
- RUS Измеритель давления компрессии в дизельных двигателях
- CZ Souprava k měření kompresních tlaků v diesellových motorech
- H Dieselmotorok kompresszióját mérő óra
- RO Manometrul presiunii aerului comprimat pt. motorele diesel
- F Testeur de pression cylindrique diesel
- I Tester prova compressione motori diesel
- E Medidor de presión de la compresión en los motores diesel
- CN 柴油机压力测试组套



16
PCS

70 bar
max.

FOR DIESEL
ENGINE
DO SILNIKÓW
DIESLA

BMC
& COLOR
SLEEVE



YATO
YT-7307 5

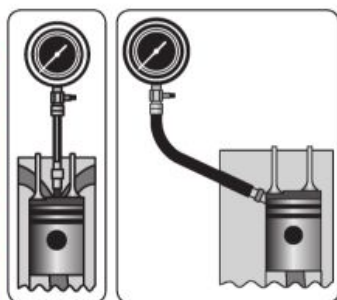

- 70 bar, 500 mm;
- 160 mm;
- M20x1.5: 75 mm; M22x1.5: 73 mm; M24x1.5: 88 mm; M24x2: 63 mm;
- M10x1: 83, 91, 102, 113, 119 mm; M10x1.25: 64, 135 mm; M12x1.25: 47 mm; M22x1.5: 118 mm;

- GB Oil pressure tester
- D Öldruckanzeige
- PL Miernik ciśnienia oleju
- RUS Тестер давления масла с адаптерами
- CZ Tester tlaku oleje
- H Olajnyomásmérő készlet
- RO Tester presiune ulei
- F Set de testeurs de pression d'huile
- I Tester misurazione pressione dell'olio
- E Manómetro de aceite
- CN 自动波箱压力表



12
PCS

185 cm
HOSE
WAŻ

FOR ALL TYPES
OF ENGINES
DO WSZYSTKICH
TYPÓW SILNIKÓW

0-35 bar 0-500 PSI

BMC
& COLOR
SLEEVE



YATO
YT-73030 10

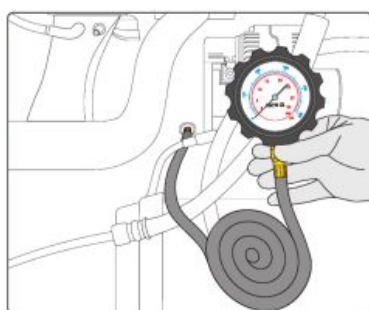

GB Compression tester
 D Druckluftmessgerät
 PL Miernik ciśnienia sprężania
 RUS Тестер компрессии

CZ Měřicí přístroj kompresního tlaku
 H Kompresszió mérő
 RO Aparat de măsurarea presiunii
 F Testeur de pression adaptateur cône

I Monometro pressione
 E Medidor de compresión
 CN 气缸压力表

FOR ALL TYPES
 DO WSZYSTKICH TYPÓW



21 bar max.
 FOR SPARK IGNITION
 DO ZAPŁONU ŚRÓDOWEGO

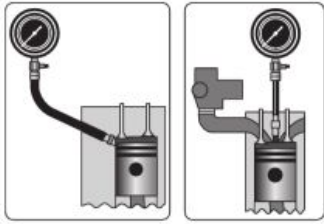

BMC & COLOR SLEEVE

RUBBER ADAPTOR ZŁĄCZE GUMOWE



THREADED ADAPTOR ZŁĄCZE GWINTOWANE



THREADED ADAPTOR ZŁĄCZE GWINTOWANE

RUBBER ADAPTOR ZŁĄCZE GUMOWE



YATO		YATO		YATO	
YT-7300	24/48	YT-7301	12/24	YT-7302	6/24

GB Flow meter common rail adapter set
 D Überlauf-Diagnosesatz für die Einspritzdüse Common rail
 PL Przelewowy zestaw diagnostyczny do wtryskiwaczy common rail
 RUS Диагностический набор к форсункам common rail; переливной
 CZ Souprava na diagnostiku vstřikovačů common rail, průtoková
 H Diagnosztikai készlet common rail injektorokhoz, átfolyós
 RO Set diagnostic preaplin pt. injectoare common rail
 F Kit de test de débit d'injecteur common rail
 I Set controllo portata iniettori common rail
 E Juego diagnóstico de flujo para inyectoros common rail
 CN 柴油燃油喷嘴检测工具



31 PCS
 FOR 6 CYLINDERS
 DO 6 CYLINDROR

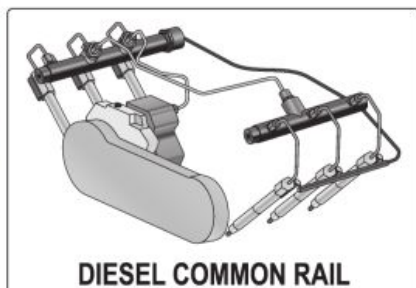

YATO		YATO	
YT-7306	5		

GB Combined sockets for alternator
D Werkzeugsatz für Lichtmaschine
PL Zestaw do alternatorów ze sprzęgłem
RUS Набор для альтернатора
CZ Souprava na opravu alternátoru
H Generátor szerszámkészlet
RO Garnitură pt. alternator

F Set de clés à l'alternateur avec l'embrayage
I Set di chiavi per smontaggio puleggia e alternatore
E Enchufes combinados para alternador
CN 发动机拆卸组套

13 PCS	1/2" 12.5mm	HEX	TORX	SPLINE	CrV
HRC 40-44	S45C	HRC 38-42	STEEL 8660	HRC 53-57	



**FOR ALTERNATORS
DO ALTERNATORÓW**



- 1/2" (12.7 mm): M10, HBS, 33T, L=110 mm; CrV; HRC 40-44;
- 1/2" (12.7 mm): T50, HBS, 33T, L=110 mm; CrV; HRC 40-44;
- M8, M10, L=75 mm; 8660; HRC 53-57;
- T40, T50, L=75 mm; 8660; HRC 53-57;
- H8, H10, L=75 mm; 8660; HRC 53-57;

- H15, 33T, L=30 mm; CrV; HRC 40-44;
- H22, 33T, L=30 mm; CrV; HRC 40-44;
- H22, L=30 mm; S45C; HRC 38-42;
- Ø 35 x 30 mm; CrV; HRC 40-44;
- 1/2" (12.7 mm) x 10 mm; CrV; HRC 40-44



YATO	1/2" (12.7 mm)	15
YT-0421		

GB Combined sockets for alternator
D Werkzeugsatz für Lichtmaschine
PL Zestaw do alternatorów ze sprzęgłem
RUS Набор для альтернатора
CZ Souprava na opravu alternátoru
H Generátor szerszámkészlet
RO Garnitură pt. alternator

F Set de clés à l'alternateur avec l'embrayage
I Set di chiavi per smontaggio puleggia e alternatore
E Enchufes combinados para alternador
CN 发动机拆卸组套

22 PCS	1/2" 12.5mm	HEX	TORX	SPLINE	CrV
3/8" 10mm	HRC 38-42	HRC 40-44	S45C	STEEL 8660	HRC 53-57

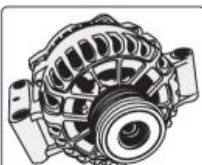

**FOR ALTERNATORS
DO ALTERNATORÓW**



- 1/2" (12.7 mm): M10, HBS, 33T, L=113 mm; CrV; HRC 40-44 / 8660; HRC 53-57;
- 1/2" (12.7 mm): T50, HBS, 33T, L=113 mm; CrV; HRC 40-44 / 8660; HRC 53-57;
- 3/8" (10 mm): M10; HBS, 33T, L=80 mm; CrV; HRC 40-44 / 8660; HRC 53-57;
- 1/2" (12.5 mm): M10; HBS, 33T, L=140 mm; CrV; HRC 40-44;
- M8, M10, L=75 mm; 8660; HRC 53-57;
- T40, T50, L=75 mm; 8660; HRC 53-57;

- H8, H10, L=75 mm; 8660; HRC 53-57;
- M8xH12, L=64 mm; 8660; HRC 53-57;
- H15, 33T, Ø 17 mm, L=30 mm, H15, 33T, Ø 19 mm, L=30 mm, H22, 33T, Ø 19 mm, L=30 mm; CrV; HRC 40-44;
- H17, H22, L=30 mm; S45C; HRC 38-42;
- Ø 35 x 30 mm; S45C; HRC 38-42;
- Ø 38 mm; S45C; HRC 38-42;
- H19x28, H21x28, H22x28; S45C; HRC 38-42;
- 1/2" (12.5 mm) (F) x H10 mm (F); CrV; HRC 40-44



YATO	1/2" (12.7 mm)	3/8" (9.5 mm)	5
YT-04211			

- GB Stroboscopic tube
- D Stroboskoplampe
- PL Lampa stroboskopowa
- RUS Стробоскопная лампа
- CZ Stroboskopická lampka
- H Stroboszkóp lámpa
- RO Lampă stroboscopică
- F Lampe stroboscopique
- I Lampada stroboscopica
- E Tubo estroboscópico
- CN 点火正时灯

DOUBLE
BLISTER



12 V

ENGINE SPEED
MAXIMUM OPERATING
8000 min⁻¹
max.

XENON

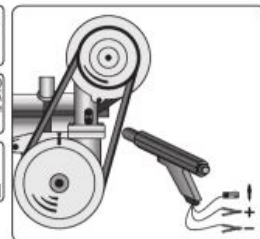

0-60°



YATO	
YT-7310	6/12

YATO	
YT-7311	6/12

YATO	
YT-7312	6/12

- GB Universal radiator pressure kit
- D Diagnosekit für Kühler
- PL Zestaw diagnostyczny do chłodnicy
- RUS Диагностический набор к радиатору
- CZ Souprava k diagnostice chladiče
- H Diagnosztikai készlet hűtőkörhöz
- RO Ansamblu pt. diagnosticarea radiatorului
- F Set diagnostique pour radiateur de voiture
- I Set universale tester pressione del radiatore
- E Juego de herramientas diagnosticas para el radiador
- CN 万用水箱压力测试组套

BMC
& COLOR
SLEEVE



14
PCS

P max.
0.25 MPa

200°C
max.

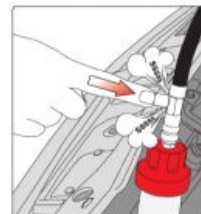

YATO	No.		
	2		General Motors
	3		Mercedes, General Motors, Jeep
	4		Peugeot, Subaru, Chrysler, Acura, General Motors, Mitsubishi, Nissan, Mazda, Toyota, Infiniti, GEO, Suzuki, Isuzu, Ford
	5		Honda, Toyota, Suzuki, Mitsubishi, Chrysler, Acura
	6		Audi, BMW, Volkswagen, Porsche
	7		Volvo, Saab, Citroen, Renault, Fiat, Alfa Romeo, Jeep
YTO-0672	8		Volkswagen
	9		Mercedes, General Motors, Jeep
	10		BMW
	11		Audi, Volkswagen
	12		Ford, Land Rover, Opel, Jaguar, Mercedes
	13		Mercedes

- GB** Hand-held vacuum pump
D Unterdruckpumpe mit Zubehör
PL Pompka podciśnieniowa z akcesoriami
RUS Насос вакуумметрического давления с принадлежностями
CZ Podtlaková-tlaková pumpa s příslušenstvím

- H** Vákuum- és ac-pumpa mérő, tartozékokkal
RO Pompa de vidare cu accesorii
F Pompe à vide avec les accessoires
I Pompa a pressione con accessori
E Bomba de subpresión con accesorios
CN 手持式真空泵

16
PCS
-1-0
bar



YATO
YT-0673 10

- GB** Hand-held vacuum pump
D Unterdruck-druckpumpe mit Zubehör
PL Pompka ciśnieniowo-podciśnieniowa z akcesoriami
RUS Насос вакуумметрического давления с принадлежностями
CZ Podtlaková-tlaková pumpa s příslušenstvím

- H** Vákuum- és ac-pumpa mérő, tartozékokkal
RO Pompa de vidare cu accesorii
F Pompe à vide avec les accessoires
I Pompa a pressione con accessori
E Bomba de subpresión-presión con accesorios
CN 手持式真空泵

22
PCS
-1-3
bar



YATO
YT-0674 5

- GB** Flexible line clamp
D Schlauchklemmensatz
PL Komplet zacisków do przewodów z cieczą
RUS Набор зажимов с фиксатором
CZ Sada hadicových svérek
H Flexibilis cső elszorító készlet
RO Clema flexibila
F Set de pices pour serrer les
I Set pinze per chiudere momentaneamente i manicotti
E Juego de alicates apretadores para conductos de líquidos
CN 油管封口钳组套

SLIDING
CARD



3
PCS
WILL NOT
CUT HOSES
NIE NISZCZY
PRZEWODÓW
NON-CONDUCTIVE
NIEPRZEWODĄCE



3/4" - 9/4"



1/2" - 5/4"



1/4" - 3/4"



- 1/4" - 3/4" for brake and fuel lines
6.3 - 19.0 mm do przewodów hamulcowych i paliwowych
1/2" - 5/4" for flexible hose
12.5 - 32.0 mm do przewodów elastycznych
3/4" - 9/4" for radiator hose clamp
19.0 - 57.0 mm do przewodu chłodnicy

YATO
YT-0840 25/50

- GB** Flexible line clamp
D Schlauchklemmensatz
PL Komplet zacisków do przewodów z cieczą
RUS Набор зажимов с фиксатором
CZ Sada hadicových svérek
H Flexibilis cső elszorító készlet
RO Clema flexibila
F Set de pices pour serrer les
I Set pinze per chiudere momentaneamente i manicotti
E Juego de alicates apretadores para conductos de líquidos
CN 油管封口钳组套

SLIDING
CARD



3
PCS
WILL NOT
CUT HOSES
NIE NISZCZY
PRZEWODÓW
BENT
WYGIĘTE
NON-CONDUCTIVE
NIEPRZEWODĄCE



- max. 32 mm for brake and fuel lines
do przewodów hamulcowych i paliwowych
max. 17 mm for flexible hose
do przewodów elastycznych
max. 32 mm for radiator hose clamp
do przewodu chłodnicy

YATO
YT-08403 5/15

- GB Spark plug socket
- D Steckschlüssel mit Gummihalterung
- PL Nasadka do świec
- RUS Головка свечная
- CZ Nastavec pro svíčky
- H Gyújtógyertya toldalék
- RO Cheie de bujii
- F Douille à bougies
- I Chiavi a bussola
- E Boquilla de bujías
- CN 六角火花塞套筒

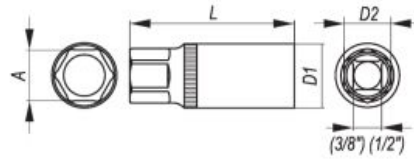

3/8" 10mm 1/2" 12.5mm

AS-DRIVE DIN 3121 CrV 50BV30



YATO	Ø	A	D1 (mm)	D2 (mm)	L (mm)	PCS	packing
YT-3851	3/8" (9.5 mm)	16.0	22.0	19.0	64.0	10	50/100
YT-1253	1/2" (12.7 mm)	16.0	22.0	19.0	64.0	10	50/100
YT-1254	1/2" (12.7 mm)	21.0	27.8	24.0	64.0	10	50/100

- GB Spark plug socket
- D Steckschlüssel mit Gummihalterung
- PL Nasadka do świec
- RUS Головка свечная
- CZ Nastavec pro svíčky
- H Gyújtógyertya toldalék
- RO Cheie de bujii
- F Douille à bougies
- I Chiavi a bussola
- E Boquilla de bujías
- CN 六角火花塞套筒



PLASTIC HANGER

3/8" 10mm 16mm

THIN WALL CIENKO-SCIENNA

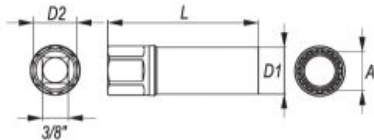

YATO	Ø	A	D1 (mm)	D2 (mm)	L (mm)	PCS
YT-38510	3/8" (9.5 mm)	14	18	16	63	25/100

- GB Spark plug socket
- D Steckschlüssel mit Gummihalterung
- PL Nasadka do świec
- RUS Головка свечная
- CZ Nastavec pro svíčky
- H Gyújtógyertya toldalék
- RO Cheie de bujii
- F Douille à bougies
- I Chiavi a bussola
- E Boquilla de bujías
- CN 六角火花塞套筒



PLASTIC HANGER

3/8" 10mm 16mm

THIN WALL CIENKO-SCIENNA

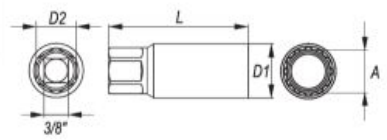

YATO	Ø	A	D1 (mm)	D2 (mm)	L (mm)	PCS
YT-38511	3/8" (9.5 mm)	16	20	16	62	25/100

- GB Spark plug socket
- D Steckschlüssel mit Gummihalterung
- PL Nasadka do świec
- RUS Головка свечная
- CZ Nastavec pro svíčky
- H Gyújtógyertya toldalék
- RO Cheie de bujii
- F Douille à bougies
- I Chiavi a bussola
- E Boquilla de bujías
- CN 六角火花塞套筒



3/8" 10mm 14mm THIN WALL CIENKO-SCIENNA

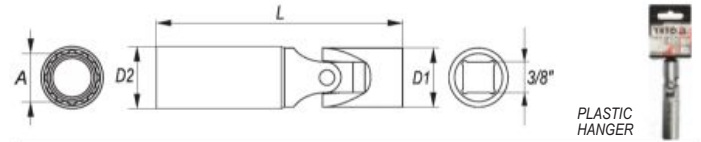

YATO	Ø	A	D1 (mm)	D2 (mm)	L (mm)	PCS
YT-38512	3/8" (9.5 mm)	14	19	20	88	25/100

- GB Spark plug socket
- D Kerzenschlüssel mit Verlängerungshebel
- PL Klucz do świec z przedłużką
- RUS Ключ к свечам с удлинителем
- CZ Klíč na svíčky s prodlužovacím nástavcem
- H Gyertyakulcs hosszabbítóval

- RO Cheie cu prelungitor, pt. bujii
- F Douille à bougies
- I Chiavi per candele a tubo
- E Llave para las bujías con extensión
- CN 火花塞套筒

PLASTIC HANGER

3/8" (10 mm) x 300 mm CrV 50BV30



YATO	Ø (mm)	PCS
YT-0817	16	10/40
YT-0818	18	10/40
YT-0819	21	10/40

16

- GB Joined glow plug socket set
- D Schlüsselsatz für Glühkerzen
- PL Zestaw kluczy do świec żarowych
- RUS Набор ключей к калильным свечам
- CZ Sada klíčů na žhavičí svíčky
- H Gyertyakulcs készlet
- RO Set chei pt. bujii incandescente
- F Set de douilles à bougies
- I Set chiavi a bussola snodate per candele
- E Juego de llaves para bujías incandescentes
- CN 预热火花塞套筒组套



6 PCS 3/8" 10mm BLOCKING SYSTEM SYSTEM BLOKOWY

8, 9, 10, 12, 14, 16 mm

CrV 50BV30



BMC & COLOR SLEEVE



YATO	Ø	PCS
YT-0534	3/8" (9.5 mm)	10

- GB Torque angle gauge
D Winkelmesser zum Anziehen von Schrauben
PL Kałomierz do dokręcania śrub
RUS Угломер для подвёртывания болтов
CZ Úhloměr k utahování šroubů
H Nyomaték szögmérő
RO Raportor pt. înșurubat șuruburi
F Rapporteur à serrer les vis
I Goniometro per il serraggio controllo
E Calibrador para apretar tornillos
CN 扭力角度规



1/2" 12.5mm 360° CrV



YATO
YT-0593 12/48

- GB Metal conduit bender
D Biegevorrichtung für Metallleitungen
PL Ciętarzka do przewodów metalowych
RUS Гибочный станок для проводов из металла
- CZ Ohýbačka kovových trubek
H Hajlító fémvezetékhez
RO Mașina de îndoit (curbat) pt. cabluri metalice
F Cintreuse au câble de frein
- I Piegatrice per fili metallici
E Dobladora de tubos de metal
CN 弯管器

SLIDING CARD

AI



125 mm max. ∅ 6 mm

235 mm max. ∅ 12 mm

YATO	L (mm)		YATO	L (mm)	
YT-0813	125	24/96	YT-0814	235	6/48

- GB Universal clutch adjustment set
D Universal-set, um die Kupplungsscheibe einstellen
PL Zestaw do centrowania tarczy sprzęgłowej
RUS Комплект для центровки дисков сцепления
CZ Univerzální sada pro nastavení spojky disk
H Kuplung központosító készlet
RO Trusa pt. centrat ambreiaje
F Centreur d'embrayage
I Set di centraggio frizione
E Herramienta alineación embrague
CN 燭磁動請苐溟



9 PCS

∅ mm 11-25

∅ 11, 15, 16.5, 17, 19, 20, 20.5, 25 mm

YATO
YT-06311 20

- GB Brake fluid tester
D Bremsflüssigkeitstester
PL Tester płynu hamulcowego
RUS Тестер тормозной жидкости
CZ Tester stavu brzdové kapaliny
H Fékfolyadék teszter
RO Tester lichid frana
F Tester de liquide de frein
I Tester del fluido frenante
E Liquido de frenos tester
CN 刹车油检测器



4 LED

SUPER VIBRAL DIAGNOSIS

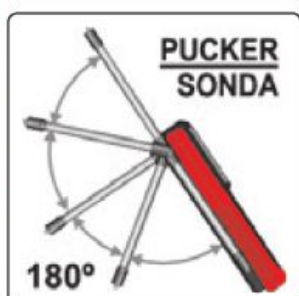

YATO
YT-72981 28/56

BLISTER CARD



- GB Brake retainer spring tool
D Montagewerkzeug für Bremsfeder
PL Ściągacz sprężynek szcęk hamulcowych
RUS Съемник для тормозных пружин
CZ Stahovač pružin brzdových čelistí
H Fékrugó szerelő szerszám
RO Dispozitiv pt. montat arc pe sabot
F Extracteur de ressorts freins
I Freno scarpa di fissaggio a molla compressor
E Herramienta para resorte retenedor de frenos
CN 刹车弹簧华司拆装器

SLIDING CARD

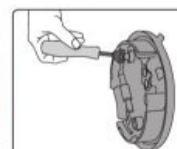

FOR DRUM BRAKES DO HAMULCOWYCH BĘBNOWYCH



YATO
YT-0685 12/96



YATO
YT-0686 12/72

- GB Brake spring pliers kit
- D Bremsbacken-montage set
- PL Zestaw do montażu szcęk hamulcowych
- RUS Набор инструментов для тормозных пружин
- CZ Sada na montáž brzdových čelistí
- H Fogókészlet fékrugóhoz
- RO Dispozitiv pt. inclocuit garnituri cilindrii receptori
- F Set pour le montage des mâchoires de freins
- I Set per montaggio molle freni
- E Juego para resortes de frenos
- CN 刹车拆卸工具组套

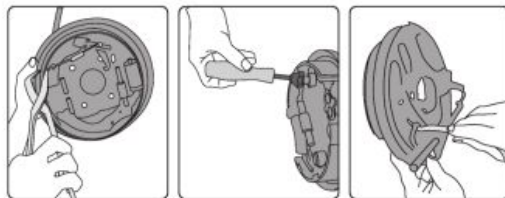

FOR DRUM BRAKES DO HAMULCOW BIEBNOŹYCH

BMC & COLOR SLEEVE



3 PCS

DOUBLE BLISTER

8 PCS

YATO	
YT-0684	6/24

YATO	
YT-0680	5

- GB Disc brake spreader
- D Scheibenbremsen Abscheider
- PL Separator do hamulców tarczowych
- RUS Распорка тормозных дисков
- CZ Přípravek na montáž brzdových prasátek
- H Fék munkahenger visszanyomó
- RO Separator disc ambreiaj
- F Séparateur des freins à disque
- I Separatore per pistoncini freno
- E Separador de frenos de discos
- CN 刹车片分离器



40-68 mm

1, 2, 4

116x60 mm
FOR BRAKE CALIPER PISTONS DO ZACISKÓW HAMULCOWYCH
WYMIAR SŁOŻY



COLOR BOX

YATO	
YT-06805	10

- GB Disc brake spreader
- D Scheibenbremsen Abscheider
- PL Separator do hamulców tarczowych
- RUS Распорка тормозных дисков
- CZ Přípravek na montáž brzdových prasátek
- H Fék munkahenger visszanyomó
- RO Separator disc ambreiaj
- F Séparateur des freins à disque
- I Separatore per pistoncini freno
- E Separador de frenos de discos
- CN 刹车片分离器

0-65 mm
10" (25.5 mm)
21 mm



COLOR BOX

YATO	
YT-0610	12/24

- GB Disc brake piston tool
- D Bremskolbenrücksteller universal
- PL Uniwersalny klucz do wkręcania zacisków hamulcowych
- RUS Ключ для тормозного поршня
- CZ Univerzální klíč k montáži brzdových třmenů
- H Féknyereg összenyomó
- RO Dispozitiv pt. impins etrier
- F Clé universelle pour pinces de frein
- I Attrezzo per l'arretamento della pinza dei freni
- E Llave para comprimir pistones del freno de disco
- CN 刹车分泵拆装器

3/8" 10mm

CrV



SLIDING CARD

YATO	
YT-0683	12/96

for / dla: GM, FORD, Chrysler, VW, Fiat

- GB Disc brake pad & caliper service tool kit
- D Werkzeugsatz von manuellen Separatoren für die Bremssklemmen
- PL Zestaw ręcznych separatorów do zacisków hamulcowych
- RUS Набор ручных сепараторов для тормозных зажимов
- CZ Ruční sada na montáž kotoučových brzd
- H Fék munkahenger prés készlet
- RO Set de separatoare manuale pt. etrier frâna
- F Set de repousse piston de frein
- I Kit universale regolazione manuale per pistoncini freni
- E Juego de separadores manuales para abrazaderas de freno
- CN 刹车片分离器组套



6 PCS

ADJUSTABLE RANGE REGULOWANY ROZKŁASZ

2 PINS PINY

3 PINS PINY



BMC & COLOR SLEEVE

YATO	
YT-06827	10

11
PCS

- GB Disc brake pad & caliper service tool kit
D Werkzeugsatz von manuellen Separatoren für die Bremsklappen
PL Zestaw ręcznych separatorów do zacisków hamulcowych
RUS Набор ручных сепараторов для тормозных зажимов
CZ Ruční sada na montáž kotoučových brzd
H Fékmunkahenger prés készlet
RO Set de separatoare manuale pt. etrier frâna
F Set de repousse piston de frein
I Kit universale regolazione manuale per pistoni freni
E Juego de separadores manuales para abrazaderas de freno
CN 刹车片分离器组套

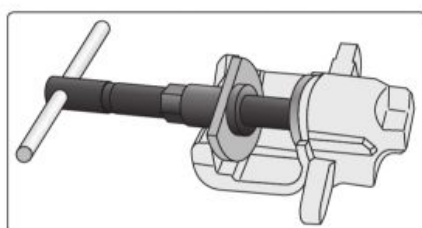
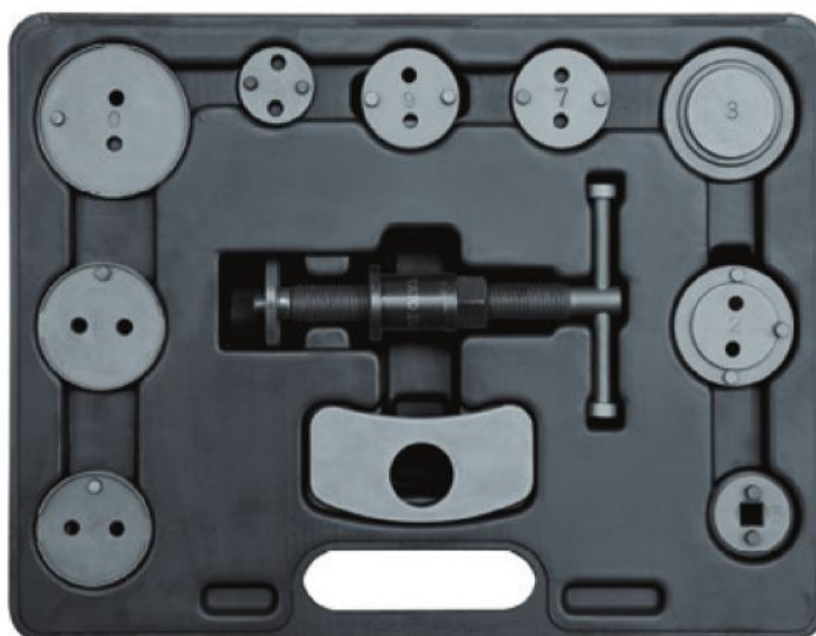

YATO	No.	zacisk przedni (F)	zacisk tylny (R)	
	1-1		silownik	
	1		plytka oporowa	
	5		adapter z gniazdem	
	2		Citroen: XM, Xantia	
YT-0681	3	Alfa Romeo, Audi, Austin, BMW, Honda, Jaguar, MB, Mitsubishi, Nissan, Rover, Toyota, VW		5
	4		Ford, Mazda, Subaru, Alfa Romeo, Saab	
	6		Nissan	
	7		Audi, Ford, Honda, Nissan, Rover, Saab, Subaru, VW	
	8	General Motors		
	9	General Motors		

- GB Disc brake pad & caliper service tool kit
D Werkzeugsatz von manuellen Separatoren für die Bremsklappen
PL Zestaw ręcznych separatorów do zacisków hamulcowych
RUS Набор ручных сепараторов для тормозных зажимов
CZ Ruční sada na montáž kotoučových brzd
H Fékmunkahenger prés készlet
RO Set de separatoare manuale pt. etrier frâna
F Set de repousse piston de frein
I Kit universale regolazione manuale per pistoni freni
E Juego de separadores manuales para abrazaderas de freno
CN 刹车片分离器组套

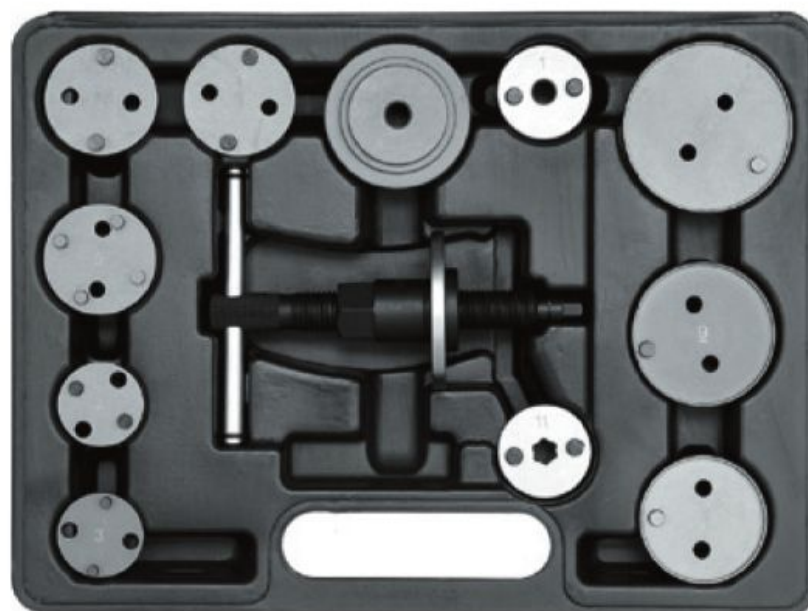

12
PCS

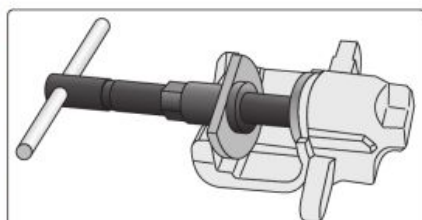

YATO	No.	zacisk przedni (F)	zacisk tylny (R)	
	0	General Motors - zaciski 2 1/2" (63.5 mm)		
	1	Adapter do przedniego zacisku		
	2		Citroen XM, Xantia (F/R)	
	3		Opel (R)	
	4		Ford (R), Mazda (R), Saab (R), Alfa Romeo 164 2.0 (R), Honda (R), General Motors (R)	
YT-0611	5		Nissan Maxima	5
	6		Nissan Primera, VW Golf IV	
	7	Audi (F), Rover, Subaru (F), Ford (F), Nissan (F), Peugeot (F), Toyota (F), VW (F)		
	8	General Motors - zaciski 1 7/8" (47.6 mm)		
	9	General Motors - zaciski 2 1/8" (54.0 mm)		
	11		Adapter do tylnego zacisku	

16

- GB Disk brake pad and caliper
- D Pneumatischer Werkzeugsatz für Bremssattelsysteme
- PL Pneumatyczny zestaw do zacisków hamulcowych
- RUS Пневматический набор к тормозным зажимам
- CZ Pneumatická souprava k montáži kotoučových brzd
- H Pneumatikus készlet fék-munkahengerekhez
- RO Ansamblu pneumatic pt. cilindre de frana
- F Set pneumatique aux séparateurs de pinces de frein
- I Kit universale regolazione pneumatico per pistoni freni
- E Juego de herramientas neumaticas para apretadores de frenos
- CN 盘式制动衬块和制动钳

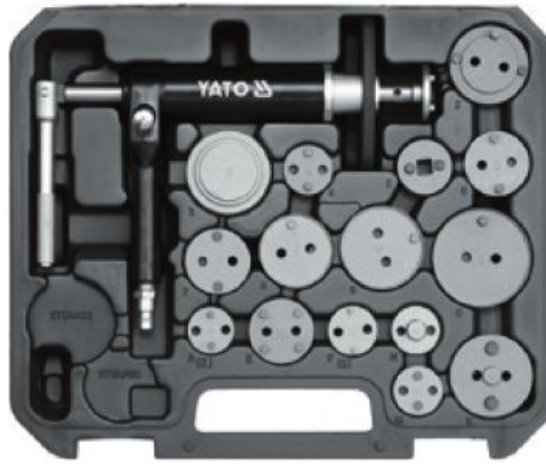

16
PCS
0.75
MPa
STANDARD

BMC
& COLOR
SLEEVE



YATO	No.	zacisk przedni (F)	zacisk tylny (R)	
YT-0671	0	General Motors - zaciski 2 1/2" (F) (63.5 mm)		5
	2		Citroen XM, Xantia (F/R)	
	3	Audi (F), Alfa Romeo (F), Fiat (F), Ford Fiesta (F), Isuzu (F), Honda Concerto (F), Jaguar (F/R), BMW (F), Mercedes-Benz (F), Mitsubishi Colt (F), Nissan: Almera, Stanza, Sunny (F), Rover (F), Toyota Camry (F), Volvo (F), VW (F)		
	4		Ford (R), Mazda (R), Saab (R), Alfa Romeo 164 2.0 (R), Honda (R), General Motors (R)	
	5	Adapter z gniazdem 3/8"		
	6		Nissan Primera (R), VW Golf IV (R)	
	7		Audi (R), Rover, Subaru (R), Ford (R), Nissan (R), Peugeot (R), Toyota (R), VW (R)	
	8	General Motors - zaciski 1 7/8" (47.6 mm)		
	9	General Motors - zaciski 2 1/8" (54.0 mm)		
	A		Renault (R)	
	E		Nissan Maxima (F/R)	
	F		Opel (R)	
	K		Citroen (R)	
	M		Ford (R), Cooper (R)	
N		Saab, Honda (F/R)		

- GB Disc brake pad & caliper service tool kit
- D Werkzeugsatz von manuellen Separatoren für die Bremsklemmen
- PL Zestaw ręcznych separatorów do zacisków hamulcowych
- RUS Набор ручных сепараторов для тормозных зажимов
- CZ Ruční sada na montáž kotoučových brzd
- H Fékmunkahenger prés készlet
- RO Set de separatoare manuale pt. etrier frâna
- F Set de repousse piston de frein
- I Kit universale regolazione manuale per pistoni freni
- E Juego de separadores manuales para abrazaderas de freno
- CN 刹车片分离器组套

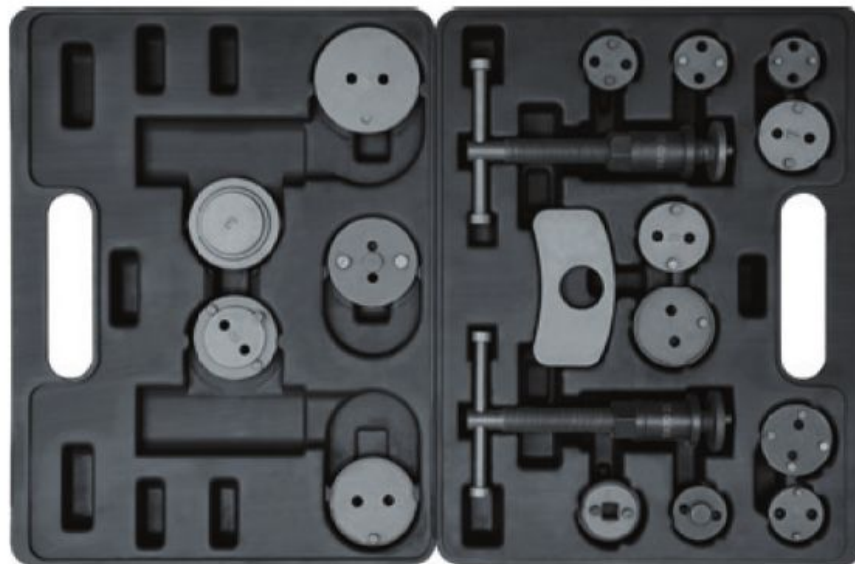
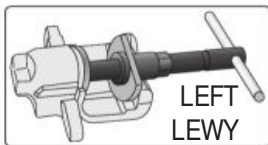

18
PCS

BMC
& COLOR
SLEEVE



YATO	No.	zacisk tylny (R)	zacisk tylny (R)		
YT-0682	1-1		silowniki z lewym i prawym gwintem	5	
	1		plytka oporowa		
	5	3/8" (10.0 mm)	adapter z gniazdem		
	0	2 1/2" (63.5 mm)	General Motors		
	2	2 1/64" (51.0 mm)	Citroen XM, Xantia		
	3	2 5/32" (55.0 mm)	Audi, Alfa Romeo, Fiat, Ford Fiesta, Honda, Jaguar, BMW, Mercedes, Mitsubishi Colt, Nissan, Rover, Austin, Toyota Camry, Volvo, VW: Passat, Golf GTI		Jaguar
	4	1 1/4" (32.0 mm)			Ford, Mazda, Saab, Alfa Romeo 164, Honda, General Motors
	6	1 21/32" (42.0 mm)			Nissan Primera, VW Golf IV
	7	1 21/32" (42.0 mm)			Audi, Rover, Subaru, Ford, Nissan, Peugeot, Toyota, VW
	8	1 7/8" (48.0 mm)	General Motors		
	9	2 1/8" (54.0 mm)	General Motors, Cadillac		
	E	1 21/32" (42.0 mm)			Nissan Maxima
	F	1 1/4" (32.0 mm)			Opel
	K	2 1/8" (54.0 mm)			Citroen
	M	1 1/4" (32.0 mm)			Ford
	N	1 1/4" (32.0 mm)	Saab, Honda		
A	1 3/16" (30.0 mm)		Renault		

GB Disc brake pad & caliper service tool kit
D Werkzeugsatz von manuellen Separatoren für die Bremsklappen
PL Zestaw ręcznych separatorów do zacisków hamulcowych
RUS Набор ручных сепараторов для тормозных зажимов

CZ Ruční sada na montáž kotoučových brzd
H Fékmunkahenger prés készlet
RO Set de separatoare manuale pt. etrier frâna
F Set de repousse piston de frein
I Kit universale regolazione manuale per pistoni freni

E Juego de separadores manuales para abrazaderas de freno
CN 刹车片分离器组套

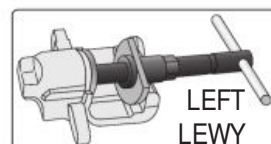

35
PCS 3/8"
10mm

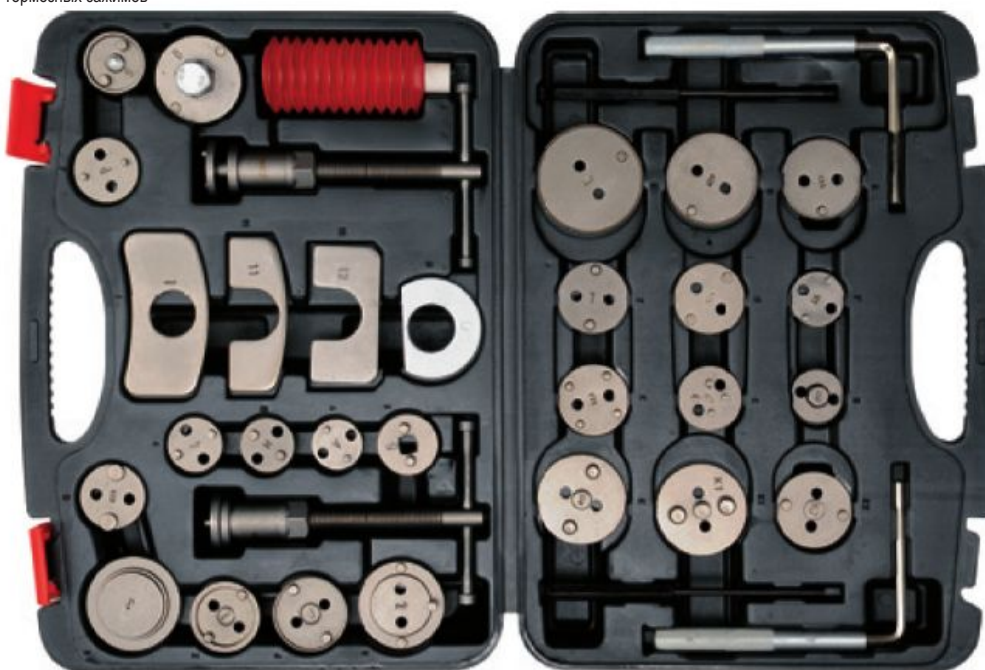

BMC
& COLOR
SLEEVE



No.	No.	zacisk przedni (F)	zacisk tylny (R)
YT-06822	2	2 1/64" (51.0 mm)	Citroen Xantia, Honda Prelude
	3	2 5/32" (55.0 mm)	Fiat, Alfa Romeo, Isuzu, Mercedes Benz, BMW, Citroen, Ford, Honda, Jaguar, Nissan, Peugeot, Rover, Toyota, VAG, Volvo
	4	1 1/4" (32.0 mm)	Ford, Mazda, Saab, Fiat, Alfa Romeo, General Motors
	5	3/8" (10.0 mm)	adapter z gniazdem
	7	1 21/32" (42.0 mm)	Nissan, VAG, Jaguar S
	6	1 21/32" (42.0 mm)	Audi, Rover, Subaru, Ford, Nissan, Peugeot, Toyota, VAG, Saab, Jaguar, GM
	8	1 7/8" (48.0 mm)	General Motors
	9	2 1/8" (54.0 mm)	General Motors, Cadillac
	0	2 1/2" (63.5 mm)	General Motors
	A	1 1/5" (30.5 mm)	Renault, BMW, Mini
	B	1 19/30" (41.5 mm)	Ford, Lincoln, Subaru
	C	1 19/30" (41.5 mm)	Mini, Nissan, Opel, Toyota
	D	2 1/64" (51.0 mm)	Renault, Citroen
	E	1 21/32" (42.0 mm)	Nissan Maxima
	F	1 1/4" (32.0 mm)	Opel, Fiat
	G	3/8" (10.0 mm)	Peugeot, GM
	J	1 22/33" (42.5 mm)	Fiat, Alfa Romeo, Audi, Citroen, Renault, Peugeot, Ford, Nissan, Saab, VAG, Subaru, Volvo
	K	2 1/8" (54.0 mm)	Citroen, Opel
	K1	2 1/8" (54.0 mm)	Renault, Citroen
	K2	1 22/23" (50.0 mm)	Citroen, Renault, Audi
P	1 19/30" (41.5 mm)	VAG, BMW, Ford, Lancia, Proton, Renault, Rover, Citroen	
M	1 1/4" (32.0 mm)	Ford, Mini, Nissan	
N	1 1/4" (32.0 mm)	Saab, Honda, Alfa Romeo, Ford Mondeo, Lancia, Volkswagen	
Z	1 3/16" (30.0 mm)	Ford, Mazda, Mitsubishi, Toyota Corolla	
	1, 11, 12	plytka oporowa	

5

16

GB Air breake bleeder
D Druckluft-Bremsenlüfter
PL Urządzenie pneumatyczne do wymiany płynu hamulcowego
RUS Устройство для замены тормозной жидкости
CZ Sada na odvědušnění brzdové soustavy a hydraulické spojky
H Pneumatikus eszköz a fékolyadék cseréjére

RO Aparat de schimbat lichid frână
F Purger de frein et d'embrayage pneumatique
I Strumento per la sostituzione del liquido freni
E Sangrado del freno de aire comprimido
CN 气动刹车油更换机

0.27 MPa 5.0 l 6m STANDARD



$L_{w} \leq 70$ dB;
 $L_{pA} \leq 85$ dB;
 $a_s \leq 2.5$ m/s²

GREY CARTON BOX & COLOR LABEL



11 ADAPTERS / 11 ADAPTERÓW

YATO
YT-06845 1

- GB Coil spring clamp
- D Federspanner
- PL Ściągacz do sprężyn
- RUS Съёмник пружин
- CZ Stahovák pružin
- H tlumičů automobilů
- H Rugóösszehűző

- FO Presa pt. arcuri
- F Compresseurs de ressort
- I Estrattore
- E Extractor de muelles
- CN 弹簧夹



2 PCS
1/2" (12.5 mm)
21 mm



YATO	Ø (mm)	L (mm)	
YT-0605	90	200	5/10



CrV

YATO	Ø (mm)	L (mm)	
YT-2544	82	370	8

COLD FORGED KÜTE NA ZIMNO

YATO	Ø (mm)	L (mm)	
YT-2546	82	280	8
YT-2547	82	355	8

- GB Vice for shock absorber
- D Halterung, Schraubstock für die Säule von MacPherson
- PL Uchwyt, imadło do kolumny MacPhersona
- RUS Тиски к подвеске Макферсона
- CZ Upínací přípravek, svěrák na nápravy McPherson
- H Fogantyú, satu MacPherson oszlophoz
- FO Măner, menghină pt. coloana MacPherson
- F Poignée et étau pour la colonne MacPherson
- I Manico e vice colonna MacPherson
- E Mandril, torno para la columna de MacPherson
- CN 弹簧避震器固定器

35-70 mm



WHITE CARTON BOX & COLOR LABEL

YATO	
YT-2537	5

- GB Macpherson spring dumper extractor
- D Abziehvorrichtung für Federn von MacPherson
- PL Ściągacz do sprężyn MacPhersona
- RUS Съёмник пружин подвески Макферсона
- CZ Stahovák pružin McPherson
- H MacPherson rugó összehűző
- FO Extractor de arcuri MacPherson
- F Compresseurs de ressort MacPherson
- I Estrattore per molle MacPherson
- E Desmontador para los resortes de MacPherson
- CN 弹簧压缩器

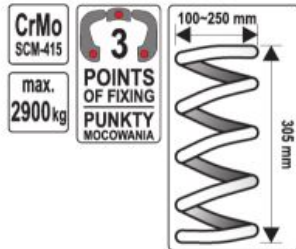

WHITE CARTON BOX & COLOR LABEL

YATO	
YT-2535	2

- GB Interchangeable fork spring compressor and removal tool
- D Abziehvorrichtung für MacPherson-Federn mit austauschbaren Halterungen
- PL Ściągacz do sprężyn MacPhersona z wymiennymi uchwytami
- RUS Стяжка для снятия пружин Макферсона со сменными полукольцами
- CZ Stahovák pružin McPherson s vyměnitelnými čelistmi
- H MacPherson rugó összehűző cserélhető pófákkal
- FO Ancoră suspensie MacPherson cu mănere interschimbabile
- F Compresseurs de ressort MacPherson
- I Smonta ammortizzatori per sospensioni MacPherson
- E Extractor de resortes MacPherson con mangos intercambiables
- CN 免拆式减震弹簧压缩器



7 PCS
65-125 mm
88-160 mm
max. 1500kg
126-212 mm



BMC & COLOR SLEEVE

YATO	
YT-2536	1

- GB** Drive nut set
D Stossdämpfer Nutmutter Einsätze
PL Zestaw nasadek do amortyzatorów
RUS Набор головок для амортизаторов
CZ Sada hlavic na uložení tlumiče
H Lengéscsillapítókiszédő szet
RO Set prezoane
F Set des embouts aux amortisseurs
I Set di chiavi per aria condizionata
E Juego de boquillas de amortiguadores
CN 拆装减震器套件组套

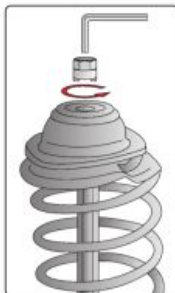

5
PCS



SLIDING
CARD



- No. 1 10.5 mm VW Golf rear
No. 2 12.5 mm VW Golf front
No. 3 14.5 mm VW Polo, Golf, Passat, Audi 80
No. 4 14.5 mm Austin Maestro
No. 5 14.0 mm Mercedes Benz C-Class (W203)

YATO	size / rozmiar (mm)	
YT-0621	10.5; 12.5; 14.5; 14.5; 14.0	12/48

- GB** Turnbuckle for shock absorber's top lid
D Schlüsselset zum Befestigen der Stoßdämpfer
PL Zestaw kluczy do mocowania amortyzatorów
RUS Набор ключей для крепления амортизаторов
CZ Sada klíčů k montáži tlumičů
H Kulcskészlet lengéscsillapítók rögzítéséhez

- RO** Set chei pt. fixare amortizoare
F Set de clés pour amortisseurs
I Set chiavi per montare ammortizzatori
E Juego de llaves para la instalación de amortiguadores
CN 避震器拆卸器

39 PCS	CrMo SCM415	CrV 6140	CrV 50BV30	STEEL 8660
-----------	----------------	-------------	---------------	---------------



BMC
& COLOR
SLEEVE



YATO	size / rozmiar (mm)	type of car / model samochodu	size / rozmiar (mm)	type of car / model samochodu
YT-0628	10.5 x 3.5	VW Golf Rear Axle	CrV 6140	D5 Nissan
	12.5 x 3.5	VW Golf Front Axle		D10 Nissan, Ford
	14.5 x 5	VW Polo, Golf, Passat, Audi 80		8 Mercedes-Benz
	14.5 x 3	Austin Maestro	CrV 6140	9 Opel/Vauxhall, Chrysler
	14 x 2.5	Mercedenz Benz W203 (C-class), W209 (CLK)		10 Chrysler, Ford
	14	Honda, Nissan	11 Japanese Cars	
	16	VW, Audi, Seat, Fiat	CrV 50BV30	5 Honda
	17	Ford, VW, Audi, Seat, Fiat		6 Seat, Fiat, Citroen, Peugeot, Ford, Opel, Renault, Japanese Cars, BMW
	18	Ford, VW, Audi, Seat, Rover, Fiat, Opel, Peugeot, Renault, Japanese Cars	STEEL 8660	7 VW, Audi, Seat, Fiat, Citroen, Peugeot, Mercedes-Benz (W203), Renault
	19	VW, Audi, Seat, Citroen, Fiat, Opel, Peugeot, Toyota		8 Mercedes-Benz
	21	Mercedenz-Benz W203, Chrysler, VW, Audi, Ford, Japanese Cars	STEEL 8660	3 Mercedes-Benz, Opel, Renault
	22	VW, Audi, Seat, Citroen, Fiat, Opel, Peugeot, Renault, BMW		3.5 Chrysler, Ford, Citroen, Peugeot
24	Volvo	STEEL 8660	4 Citroen, Peugeot	
27	VW, Audi, Citroen, Peugeot		M12 Opel/Vauxhall	
4	Nissan	STEEL 8660	T50 Nissan, Ford	
5.2	VW, Audi, Nissan		T60 Ford	
6	VW, Audi, Renault	STEEL 8660		
6.3	Nissan			
7	VW, Audi, Seat, Fiat			
8	Seat, Fiat			
9	Japanese Cars			
10	Seat, Fiat, Volvo			
12	Seat, Fiat			

- GB** Tire valve stem inserter
D Abziehvorrichtung für die Gummiventile
PL Przeciagacz do zaworków gumowych
RUS Протяжка к резиновым клапанам

- CZ** Páka k provlékání bezdušových ventilů
H Szijfeszesség mérő
RO Broșă pt. supapele cauciucate
F Levier tire-valve

- I** Brocca valvola di gomma
E Brocha de tracción para las válvulas de goma
CN 气门插入工具

SLIDING
CARD



290
mm

RUBBER
VALVES
ZAWORY
GUMOWE



YATO	L (mm)	
YT-0619	290	12/72

- GB Wheel balance pliers
 D Auswuchtgewicht-Zange
 PL Szczypce do wyważania kół
 RUS Клещи для балансировки колес
 CZ Kleště pro vyvažování kol
 H Centírsúly szerelő szerszám
 RO Cleste pt. cauciuc
- F Pincas pour le contrepois à agrafe de roue de voiture
 I Pinze per equilibrio ruota
 E Tenazas de equilibrar ruedas
 CN 平衡钳

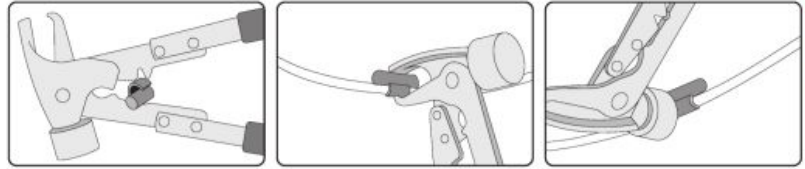

SLIDING CARD

YATO	
YT-0643	12/48

- GB Deep thin wall impact sockets
 D Schon-Kraftschraubereinsatz für Alufelgen
 PL Zestaw nasadek udarowych do felg aluminiowych
 RUS Набор головок для алюминиевых дисков
 CZ Sada nástrčných klíčů na alu ráfky
 H Hosszított dugókulcs készlet, könnyűfém felnikhez
 RO Diblu de impact cu mufare in interior
 F Set de douilles profondes à choc
 I Set di chiavi a bussola per dadi ruota di alluminio
 E Juego de boquillas de percusión para llantas de aluminio
 CN 风动薄壁长套筒



3 PCS	1/2" 12.5mm	17 19 21 mm
CrMo SCM-440	26 29 31 mm	AS-DRIVE

BMC & COLOR BOX



- for service station and tire workshops
 - for maximum impact loads
 - drive locks
 - ultra thin walls and nylon cover for working with alu rims
 - anodised colour finish for fast identification of size
- dla serwisów i warsztatów oponiarskich
 - do największych obciążeń udarowych i tętniących
 - zamki blokujące
 - ultra cienkie ścianki i nylonowe pokrycie do pracy z felgami aluminiowymi
 - anodowane kolorowe wykończenie dla szybkiej identyfikacji rozmiaru

YATO	
YT-1056	1/2" (12.7 mm) 12/24

- GB Rubber valve core torque tool
 D Drehmomentwerkzeug für gummi Dichtende Reifenventileinsätze
 PL Klucz dynamometryczny do zaworków gumowych
 RUS Ключ динамометрический для резиновых клапанов
 CZ Klíč momentový k montáži gumových ventilů
 H Szeleptűkiszserelő kulcs gumitömítésű szelephez
 RO Surubelnita din plastic pt. supapa
 F Clé dynamométrique pour soupapes
 I Giravite dinamometrica per valvole
 E Llave dinámometrica de válvulas de goma
 CN 定扭橡胶气门芯拆卸工具

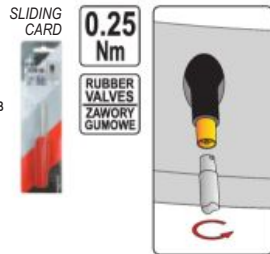

- GB Metal valve core torque tool
 D Drehmomentwerkzeug für metallisch Dichtende Reifenventileinsätze
 PL Klucz dynamometryczny do zaworków metalowych
 RUS Ключ динамометрический для металлических клапанов
 CZ Klíč momentový k montáži kovových ventilů
 H Szeleptűkiszserelő kulcs fémtömítésű szelephez
 RO Surubelnita metalica pt. supapa
 F Clé dynamométrique pour soupapes
 I Giravite dinamometrica per valvole
 E Llave dinámometrica de válvulas de metal
 CN 定扭橡胶气门芯拆卸工具

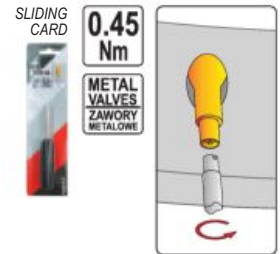

YATO	
YT-0795	50/200

YATO	
YT-0796	50/200

- GB Cross rim wrench
 D Kreuzschlüssel
 PL Krzyżakowy klucz do kół
 RUS Ключ-крест балансный
 CZ Klíč na kola křížový
 H Kereszt kerékkulcs
 RO Cheie în cruce pt. roți
 F Clé en croix aux roues
 I Chiavi a croce per auto ruota
 E Llave cruz para ruedas
 CN 十字套筒扳手



CrV

PLASTIC HANGER



YATO	size / rozmiar	
YT-0800	17 x 19 x 21 x 22 mm	10
YT-0801	17 x 19 x 21 x 1/2" (12.7 mm)	10
YT-0802	24 x 27 x 32 x 3/4" (19.0 mm)	3

GB T-type sleeved ratchet wrench
D Radmutter Schlüssel für Autos
PL Klucz do kół samochodowych
RUS Ключ к автомобильным колесам
CZ Klíč na kola automobilů
H Kerékkulcs
RO Cheie pt. roți de automobile

F Clé cliquet aux roues
I Chiavi per ruota auto
E Llave para las ruedas de automóviles
CN T型棘轮扳手组套

PLASTIC HANGER



4 PCS
1/2" 12.5mm
44T
CrV 50BV30
AS-DRIVE



1/2" (12.7 mm): 17, 19, 21, 23 mm

YATO size / rozmiar
YT-0803 5/10

GB Folding cross wrench
D Radmutter Schlüssel
PL Składany klucz do kół w etui
RUS Балонный крестовой разборный ключ с чехлом
CZ Skládací křížový klíč na matice
H Összecsukható kereszt csavarkulcs

RO Cheie cruce pt. șuruburi roți
F Clé démonte roue en croix démontable
I Pierevole cress chiave
E llave para las ruedas de automóviles
CN 快速十字扳手

TEXTILE WALLET & COLOR BOX

4 PCS
17 mm
19 mm
21 mm
23 mm
1/2" 12.5mm
CrV
WALLET ETUI



YATO size / rozmiar
YT-08035 1/2" (12.7 mm) 10

GB Electric impact wrench
D Elektro-Schlagschrauber
PL Elektryczny klucz udarowy
RUS Электрический гайковерт
CZ Elektrický rázový uťahovák
H Elektromos ütvecsavarozó
RO Pistol de impact electric
F Clé à choc électrique
I Avvitatore elettrico ad impulso
E llave de impacto eléctrica
CN 电动冲击扳手

230V~50Hz
450 W
450 Nm
0-3300 rpm
T 0-3300 rpm
1/2" 12.5mm
17, 19, 21, 22 mm
4m
4m

GB Electric impact wrench
D Elektro-Schlagschrauber
PL Elektryczny klucz udarowy
RUS Электрический гайковерт
CZ Elektrický rázový uťahovák
H Elektromos ütvecsavarozó
RO Pistol de impact electric
F Clé à choc électrique
I Avvitatore elettrico ad impulso
E llave de impacto eléctrica
CN 电动冲击扳手

230V~50Hz
1020 W
600 Nm
0-2600 rpm
T 2700 rpm
1/2" 12.5mm
17, 19, 21, 22 mm
4m
4m



$L_{pk} = 96 \pm 3$ dB;
 $L_{pk} = 107 \pm 3$ dB;
 $a_{sh} = 17,648 \pm 1,5$ m/s²

$L_{pk} = 100 \pm 3$ dB;
 $L_{pk} = 111 \pm 3$ dB;
 $a_{sh} = 18,9 \pm 1,5$ m/s²

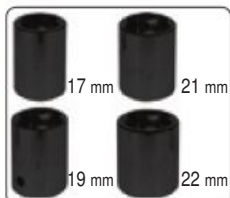

BMC & COLOR SLEEVE

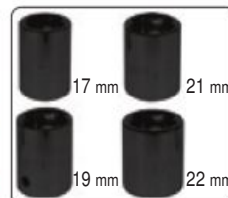

BMC & COLOR SLEEVE

YATO W
YT-82020 450 5

YATO W
YT-82021 1020 3

GB Tire lever
D Reifenmontierhebel
PL Łyżka do opon
RUS Прибор для шиномонтажа
CZ Montážní páka na pneumatiky

H Gumiabroncs kar
RO Levier pt. roti
F Cuillère à pneus
I Leva per pneumatici

E Desmontable para las llantas
CN 轮胎起子

300 mm	400 mm	500 mm	600 mm	CrV
--------	--------	--------	--------	-----



YATO	size / rozmiar (mm)	
YT-0807	300	20
YT-0808	400	20
YT-0809	500	5/20
YT-0810	600	5/20

GB Tire lever
D Reifenmontierhebel
PL Łyżka do opon
RUS Прибор для шиномонтажа

CZ Montážní páka na pneumatiky
H Gumiabroncs kar
RO Levier pt. roti
F Cuillère à pneus

I Leva per pneumatici
E Desmontable para las llantas
CN 撬棒



380 mm	CrMo
--------	------



YATO	size / rozmiar (mm)	
YT-0811	380	10/50

GB Rectangular telescopic inspection mirror
D Teleskop Inspektionspiegel
PL Lusterko inspekcyjne

RUS Зеркало инспекционное телескопическое
CZ Zrcátko kontrolní teleskopické
H Vizsgáló tükör, teleszkópos nyéllé

RO Oglinda telescopica pt. inspectie
F Miroir d'inspection
I Telescopio ispezione specchietto
E Espejo rectangular telescópico de inspección
CN 可伸缩矩形检测镜

50x90 mm	TELESCOPIC HANDLE 285x770 mm
----------	------------------------------



YATO		
YT-0660		12/144

GB LED lighted telescopic inspection mirror
D Prüßpiegel mit Beleuchtung
PL Lusterko inspekcyjne z lampką

RUS Зеркало досмотровое с подсветкой
CZ Inspekční zrcadélko s lampou
H Vizsgáló tükör, lámpával

RO Oglindă pt. inspectie cu lampă
F Miroir d'inspection avec lampe
I Specchio di ispezione con lampada
E Espejo de control con lámpara
CN 带灯检测镜

205 - 920 mm, Ø 54 mm	LED	SS FINISHED STEEL TEL. NERZOBNA
-----------------------	-----	---------------------------------



YATO		
YT-0663		10/100

GB Telescopic magnetic pick up tool
D Teleskop magnet Heber
PL Chwytyk teleskopowy z magnesem
RUS Захват магнитный телескопический

CZ Patka teleskopická magnetická
H Felszedő mágnes, teleszkópos nyéllé
RO Telescop magnetic
F Capteur magnétique

I Telescopio magnetico
E Herramienta levantadora magnética, telescópica
CN 可伸缩磁性拾拾器

2 kg	MAGNETIC	TELESCOPIC HANDLE 250x750 mm
------	----------	------------------------------



YATO		
YT-0661		12/144

GB Telescopic magnetic pick up tool
D Teleskop magnet Heber
PL Chwytyk teleskopowy z magnesem
RUS Захват магнитный телескопический

CZ Patka teleskopická magnetická
H Felszedő mágnes, teleszkópos nyéllé
RO Telescop magnetic
F Capteur magnétique avec une diode

I Telescopio magnetico
E Herramienta levantadora magnética, telescópica
CN 可伸缩磁性拾拾器

MAGNETIC	190 - 800mm TELESCOPIC HANDLE TELESKOPOWY UCHWYT	LED
----------	--	-----



YATO		
YT-06611		12/144

16

GB Telescopic magnetic pick up tool
D Teleskop magnet Heber
PL Chwytyk teleskopowy z magnesem
RUS Захват магнитный телескопический
CZ Patka teleskopická magnetická
H Felszedő mágnes, teleszkópos nyéllé
RO Telescop magnetic
F Capteur magnétique telescopique
I Telescopio a specchio
E Herramienta levantadora magnética, telescópica
CN 可伸缩磁性拾拾器

22.5 kg	82 mm	TELESCOPIC HANDLE UCHWYT TELESKOPOWY 59~99 cm
---------	-------	---



YATO	L (mm)	
YT-0860	59-99	6/24

GB Telescopic pick up and mirror set
D Inspektionsatz: Spiegel + Greifer
PL Zestaw inspekcyjny: lusterko + chwytyk
RUS Проверочный набор + держатель и зеркальце
CZ Inspekční souprava: zrcadlo + držák
H Teleszkópos ellenőrző készlet
RO Garnitură de control: oglindă + benă
F Kit miroir + grappin
I Set per ispezione: specchio + supporto
E Juego de inspección: espejo + cuchara de mordazas
CN 检测镜拾拾器组套

PLASTIC BOX & DOUBLE BLISTER	4 PCS	0.5 kg (max) 1.5 kg (max)	MAGNETIC	100 - 600 mm TELESCOPIC HANDLE UCHWYT TELESKOPOWY	250 - 930 mm, Ø 57 mm TELESCOPIC HANDLE UCHWYT TELESKOPOWY
------------------------------	-------	---------------------------	----------	---	--



YATO		
YT-0662		10/40

GB Magnetic parts tray
D Magnetschale
PL Miska magnetyczna
RUS Магнитный поднос
CZ Miska magnetická
H Mágneses tálca

RO Tava magnetica
F Bol magnétique
I Ciotola magnetica

E Bandeja de accesorios magnética
CN 磁盘



Ø mm
110



Ø mm
150

YATO
YT-08295 12/48

YATO
YT-0830 12/48

GB Magnetic parts tray
D Magnetschale
PL Miska magnetyczna
RUS Магнитный поднос
CZ Miska magnetická
H Mágneses tálca
RO Tava magnetica
F Bol magnétique
I Ciotola magnetica
E Bandeja de accesorios magnética
CN 磁盘



0.10-0.12 T (TESLA)
Ø mm
150



YATO
YT-08305 20

GB Magnetic parts tray
D Magnetschale
PL Miska magnetyczna
RUS Магнитный поднос
CZ Miska magnetická
H Mágneses tálca
RO Tava magnetica
F Bol magnétique
I Ciotola magnetica
E Bandeja de accesorios magnética
CN 磁盘



COLOR BOX
350x150 mm



YATO
YT-0831 6/12

GB Magnetic tool holder
D Magnet Werkzeughalter
PL Listwa magnetyczna
RUS Магнитная рейка
CZ Magnetický držák nářadí

H Mágneses tartó
RO Suport magnetic
F Barre et porte
I Striscia magnetica

E Bandeja de accesorios magnética
CN 磁性工具架



SLIDING CARD



YATO
YT-0835 4/16

GB Magnetic holder for tools
D Magnethalter für Schlagschrauber
PL Uchwyt magnetyczny na narzędzia
RUS Магнитный держатель для ударного гайковерта
CZ Magnetický držák nářadí
H Mágneses tartó
RO Suport magnetic pt. scule pneumatice
F Support magnétique pour outils pneumatiques
I Fissaggio magnetico per chiave ad impulsi pneumatica
E Soporte magnético para llave de impacto
CN 磁性喷枪架

15 kg max.
MAGNETIC



COLOR BOX



YATO
YT-08707 5/10

GB Tweezer
D Pinzette
PL Peşeta
RUS Пинцет

CZ Pinzeta
H Csipesz
RO Pensetă
F Pince

I Pinza
E Pinzas
CN 镊子

SLIDING CARD



302 STAINLESS STEEL
ANTI MAGNETIC
ANTIACID
KWASO-ODPORNA



140 mm HRC 30

YATO
YT-6903 L (mm) 140 20/240



115 mm HRC 30

YATO
YT-6907 L (mm) 115 20/240



140 mm HRC 40

YATO
YT-6916 L (mm) 140 20/240

- GB Workshop creeper
- D Werkstatt-Liege
- PL Leżanka warsztatowa
- RUS Лежак ремонтный
- CZ Lehátko
- H Fekpad gurulos
- RO Targa
- F Chariot de visite
- I Lettino sdraio sotto vettura
- E Camilla de taller
- CN 汽修躺板



100 cm
WHEEL x6
TOLK*

WHITE
CARTON BOX
& COLOR LABEL

YATO
YT-0880 1



91 cm
WHEEL x6
TOLK*
120 kg
150 kg

COLOR BOX

YATO
YT-08802 1

- GB LED rechargeable floodlight
- D Akku-Diodenscheinwerfer
- PL Reflektor diodowy akumulatorowy
- RUS Светодиодный аккумуляторный прожектор
- CZ LED reflektor dobijeci
- H LED reflektor újratölthető
- RO Reflector cu led dioda pe acumulatori
- F Projecteur a LED rechargeable
- I Lampada a LED a batteria
- E LED reflector recargable
- CN 工作灯

10W 3.7V 4400mAh Li-Ion 800 lm 6000 K
Micro USB CHARGING TIME COOL DOWN TIME WORK TIME COOL DOWN TIME 5.5 h 2.5 h

COB
LED



COLOR BOX

YATO
YT-81820 6/12

- GB LED rechargeable floodlight
- D Akku-Diodenscheinwerfer
- PL Reflektor diodowy akumulatorowy
- RUS Светодиодный аккумуляторный прожектор
- CZ LED reflektor dobijeci
- H LED reflektor újratölthető
- RO Reflector cu led dioda pe acumulatori
- F Projecteur a LED rechargeable
- I Lampada a LED a batteria
- E LED reflector recargable
- CN 工作灯

10W 6V 4x AAA 680 lm 3 LIGHTING MODES VERY BRIGHT
PA6 FIBERGLASS WEAVING SQUARE MAGNETIC

COB
LED



COLOR BOX

• 3 lighting modes:
100%, 30%, strobe

• 3 tryby świecenia:
100%, 30%, pulsowanie

YATO
YT-81821 8/16

- GB LED lamp
- D Diodenscheinwerfer
- PL Reflektor diodowy
- RUS Светодиодный прожектор
- CZ LED reflektor
- H Diódás reflektor
- RO Reflector diodă
- F Projecteur LED
- I Faretto LED
- E Reflector de diodos
- CN 工作灯

80W 6000 lm 6000 K 230V-50Hz 20000 h IP65

COB
LED



WHITE CARTON BOX
& COLOR LABEL

YATO
YT-81812 3

GB Workshop LED battery lamp
D LED Akku-handleuchte
PL Diodowa lampa warsztatowa akumulatorowa
RUS Светодиодная беспроводная лампа
CZ Ruční svítilna LED
H LED szerelő lámpák
RO Lampa portabila cu acumulator leduri
F Lampe a LED rechargeable
I Lampada LED per officina
E Linterna LED recargable
CN 可充長款針腳

CRI 95 5W 3.7V 2600mAh Li-Ion 400 lm 4500K
CHARGING TIME COAX LADOWNIA 4h WORK TIME COAX PRACY 4h IP65
IK07 HOOK HAK 2x



YATO
YT-08509 12

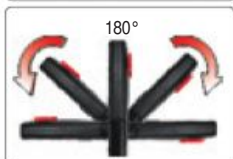

GB Workshop LED battery lamp
D LED Akku-handleuchte
PL Diodowa lampa warsztatowa akumulatorowa
RUS Светодиодная беспроводная лампа
CZ Ruční svítilna LED
H LED szerelő lámpák
RO Lampa portabila cu acumulator leduri
F Lampe a LED rechargeable
I Lampada LED per officina
E Linterna LED recargable
CN 可充長款針腳

1+1 LED 3.7V 3600mAh Li-Ion 180 lm
230V~50Hz BATTERY CHARGER LADOWNIKA 12V BATTERY CHARGER LADOWNIKA
CHARGING TIME COAX LADOWNIA 4h WORK TIME COAX PRACY 3h 2 LED
HOOK HAK MAGNETIC



YATO
YT-08502 10

GB Workshop LED battery lamp
D LED Akku-handleuchte
PL Diodowa lampa warsztatowa akumulatorowa
RUS Светодиодная беспроводная лампа
CZ Ruční svítilna LED
H LED szerelő lámpák
RO Lampa portabila cu acumulator leduri
F Lampe a LED rechargeable
I Lampada LED per officina
E Linterna LED recargable
CN 可充長款針腳

2W 3.7V 1100mAh Li-Ion 200 lm 2.5 h
CHARGING TIME COAX LADOWNIA 2.5 h WORK TIME COAX PRACY 2.5 h
USB BATTERY CHARGER LADOWNIKA IP54 HOOK HAK
POLYCARBONATE DIFFUSER "KÓR" Z PRAKTYCZNYMI x2



YATO
YT-08501 20

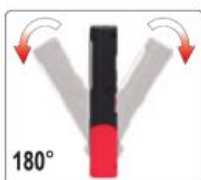

GB Workshop LED battery lamp
D LED Akku-handleuchte
PL Diodowa lampa warsztatowa akumulatorowa
RUS Светодиодная беспроводная лампа
CZ Ruční svítilna LED
H LED szerelő lámpák
RO Lampa portabila cu acumulator leduri
F Lampe a LED rechargeable
I Lampada LED per officina
E Linterna LED recargable
CN 可充長款針腳

3W 3.7V 2200mAh Li-Ion 350 lm 4 h
CHARGING TIME COAX LADOWNIA 4h WORK TIME COAX PRACY 3.5 h
USB BATTERY CHARGER LADOWNIKA IP54 HOOK HAK
POLYCARBONATE DIFFUSER "KÓR" Z PRAKTYCZNYMI x2



YATO
YT-08560 12

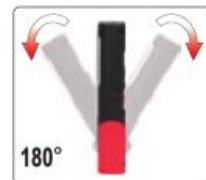

GB Workshop LED battery lamp
 D LED Akku-handleuchte
 PL Diodowa lampa warsztatowa akumulatorowa
 RUS Светодиодная беспроводная лампа
 CZ Ruční svítidla LED
 H LED szerelő lámpák
 RO Lampa portabila cu acumulator leduri
 F Lampe a LED rechargeable
 I Lampada LED per officina
 E Linterna LED recargable
 CN 可充長款鉗腳

FRONT LIGHTING FUNCTION (LAMP)	5+3 W	3.7V 2600mAh Li-Ion	CHARGING TIME (20°C) (LAMP)
600/260 lm	6500 K	USB BATTERY CHARGER (LAMP)	4h
COB LED		WORK TIME (20°C) (LAMP)	2.5/5.5 h
POLYCARBONATE DIFFUSER (KŁOSZ Z POLIMERU)		MAGNETIC	



Micro USB

HANGING COLOR BOX

YATO YT-08518 12

GB Workshop LED battery lamp
 D LED Akku-handleuchte
 PL Diodowa lampa warsztatowa akumulatorowa
 RUS Светодиодная беспроводная лампа
 CZ Ruční svítidla LED
 H LED szerelő lámpák
 RO Lampa portabila cu acumulator leduri
 F Lampe a LED rechargeable
 I Lampada LED per officina
 E Linterna LED recargable
 CN 可充長款鉗腳

FRONT LIGHTING FUNCTION (LAMP)	7+3 W	3.7V 2600mAh Li-Ion	4.5h CHARGING TIME (20°C) (LAMP)
60-600 lm 120 lm	6500 K	USB BATTERY CHARGER (LAMP)	1.5-16.5h WORK TIME (20°C) (LAMP)
COB LED		LED CHARGE INDICATOR (VESZKÁNK MŰKÖDÉSÉNEK BATERE)	POLYCARBONATE DIFFUSER (KŁOSZ Z POLIMERU)
IP54		HOOK HAK	



Micro USB

HANGING COLOR BOX

YATO YT-08519 20

GB Workshop LED battery lamp
 D LED Akku-handleuchte
 PL Diodowa lampa warsztatowa akumulatorowa
 RUS Светодиодная беспроводная лампа
 CZ Ruční svítidla LED
 H LED szerelő lámpák
 RO Lampa portabila cu acumulator leduri
 F Lampe a LED rechargeable
 I Lampada LED per officina
 E Linterna LED recargable
 CN 可充長款鉗腳

FRONT LIGHTING FUNCTION (LAMP)	3W	3.7V 2200mAh Li-Ion	CHARGING TIME (20°C) (LAMP)
250 lm	6000 K	230V-50Hz BATTERY CHARGER (LAMP)	5h
IP54		WORK TIME (20°C) (LAMP)	3.5 h
IK07		HOOK HAK	
POLYCARBONATE DIFFUSER (KŁOSZ Z POLIMERU)		MAGNETIC	



Micro USB

COB LED

360°

HANGING COLOR BOX WITH WINDOW

YATO YT-08563 10

GB Workshop LED battery lamp
 D LED Akku-handleuchte
 PL Diodowa lampa warsztatowa akumulatorowa
 RUS Светодиодная беспроводная лампа
 CZ Ruční svítidla LED
 H LED szerelő lámpák
 RO Lampa portabila cu acumulator leduri
 F Lampe a LED rechargeable
 I Lampada LED per officina
 E Linterna LED recargable
 CN 可充長款鉗腳

FRONT LIGHTING FUNCTION (LAMP)	3.5+3 W	3.7V 2200mAh Li-Ion	CHARGING TIME (20°C) (LAMP)
280 lm	6000 K	USB BATTERY CHARGER (LAMP)	4h
IP54		WORK TIME (20°C) (LAMP)	3.5 h
IK07		x2 HOOK HAK	
POLYCARBONATE DIFFUSER (KŁOSZ Z POLIMERU)		x3	



Micro USB

SMD LED

180°

360°

HANGING COLOR BOX

YATO YT-08508 12

GB Workshop LED battery lamp
D LED Akku-handleuchte
PL Diodowa lampa warsztatowa akumulatorowa
RUS Светодиодная беспроводная лампа
CZ Ruční svítidla LED
H LED szerelő lámpák
RO Lampa portabila cu acumulator leduri
F Lampe a LED rechargeable
I Lampada LED per officina
E Linterna LED recargable
CN 可充裝款鈎臂

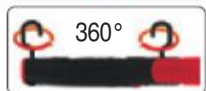

HANGING COLOR BOX

YATO YT-08507 12

GB Workshop LED battery lamp
D LED Akku-handleuchte
PL Diodowa lampa warsztatowa akumulatorowa
RUS Светодиодная беспроводная лампа
CZ Ruční svítidla LED
H LED szerelő lámpák
RO Lampa portabila cu acumulator leduri
F Lampe a LED rechargeable
I Lampada LED per officina
E Linterna LED recargable
CN 可充裝款鈎臂



COB LED



COLOR BOX



YATO YT-08504 10

GB Workshop LED battery lamp
D LED Akku-handleuchte
PL Diodowa lampa warsztatowa akumulatorowa
RUS Светодиодная беспроводная лампа
CZ Ruční svítidla LED
H LED szerelő lámpák
RO Lampa portabila cu acumulator leduri
F Lampe a LED rechargeable
I Lampada LED per officina
E Linterna LED recargable
CN 可充裝款鈎臂



LED



COLOR BOX



YATO YT-08505 10

GB LED workshop lamp
D LED Werkstattlampe
PL Diodowa lampa warsztatowa
RUS Светодиодная беспроводная лампа
CZ Montážní lampy
H LED lámpa
RO Lampa cu LED
F Lampe d'atelier a LED
I Lampada LED per officina
E Lámpara de taller LED
CN 可充裝款鈎臂



LED

DOUBLE BLISTER



YATO YT-08523 10

GB LED workshop lamp
 D LED Werkstattlampe
 PL Diodowa lampa warsztatowa
 RUS Светодиодная беспроводная лампа
 CZ Montážní lampa
 H LED szerelő lámpák
 RO Lampa cu LED
 F Lampe d'atelier a LED
 I Lampada LED per autofficina
 E Lámpara de taller LED
 CN 可充養駝釘脩



60+1 LED	13000 MCD	7.2V 800mAh (NiMH)	230V-50Hz BATTERY CHARGED LADZAWARKA
WORK TIME CZAS PRACY 4h	CHARGING TIME CIESZACOWANIE 4h	WATER PROOF OPORNINA NA WODĘ	HOOK HAK
12V BATTERY CHARGER ŁADOWNIK	LED	MAGNETIC	

DOUBLE BLISTER



YATO
YT-0852 5/20

GB LED workshop lamp
 D LED Werkstattlampe
 PL Diodowa lampa warsztatowa
 RUS Светодиодная беспроводная лампа
 CZ Montážní lampa
 H LED szerelő lámpák
 RO Lampa cu LED
 F Lampe d'atelier a LED
 I Lampada LED per autofficina
 E Lámpara de taller LED
 CN 可充養駝釘脩



8+1 LED	280 lm	3 LIGHTS OFF/ON SPLIT SWICHA	IP65
WORK TIME CZAS PRACY 4 h 8 LED	1.5V 3x AA	HOOK HAK	MAGNETIC

SMD LED



COLOR BOX



YATO
YT-08513 50

GB LED workshop lamp
 D LED Werkstattlampe
 PL Diodowa lampa warsztatowa
 RUS Светодиодный светильник для мастерской
 CZ Montážní lampa
 H LED szerelő lámpák
 RO Lampa cu LED
 F Lampe d'atelier a LED
 I Lampada LED per autofficina
 E Lámpara de taller LED
 CN 可充養駝釘脩



8 LED	80 lm	1.5V 3x AAA	WORK TIME CZAS PRACY 20 h 8 LED
--------------	--------------	--------------------	--

SMD LED

SLIDING CARD



YATO
YT-08514 12/72

GB LED workshop lamp
 D LED Werkstattlampe
 PL Diodowa lampa warsztatowa
 RUS Светодиодная лампа LED
 CZ Montážní lampa
 H LED szerelő lámpák
 RO Lampa cu LED
 F Lampe d'atelier a LED
 I Lampada LED per autofficina
 E Lámpara de taller LED
 CN 可充養駝釘脩



4 LED	400 lm	IP65	CABLE HOSRN-F KABEL
230V-50Hz	HOOK HAK	4.9m	

POWER LED

COLOR BOX



YATO
YT-08531 10

GB Workshop LED battery lamp
D LED Akku-handleuchte
PL Diodowa lampa warsztatowa akumulatorowa
RUS Светодиодная лампа LED

CZ Ruční svítlna LED
H LED szerelő lámpák
RO Lampa portabila cu acumulator leduri
F Lampe a LED rechargeable

I Lampada LED trasportabile per illuminazione di vani motore
E Linterna LED recargable
CN 引擎盖检修灯

SMD LED

100 LED	600 lm	7.4V 2000mAh Li-Ion	230V~50Hz BATTERY CHARGER LADOWNIK
CHARGING TIME ŁADOWNIA 3-4 h	WORK TIME CZAS PRACY 4 h 100 LED	HOOK HAK	MAGNETIC



GB Workshop LED battery lamp
D LED Akku-handleuchte
PL Diodowa lampa warsztatowa akumulatorowa
RUS Светодиодная лампа LED

CZ Ruční svítlna LED
H LED szerelő lámpák
RO Lampa portabila cu acumulator leduri
F Lampe a LED rechargeable

I Lampada LED trasportabile per illuminazione di vani motore
E Linterna LED recargable
CN 引擎盖检修灯

LED

350 lm	60 LED	120 LED	7.2V 1800mAh Ni-MH	230V~50Hz BATTERY CHARGER LADOWNIK
120 LED	WORK TIME CZAS PRACY 8 h 80 LED	WORK TIME CZAS PRACY 4h 120LED	CHARGING TIME ŁADOWNIA 4-5 h	HOOK HAK

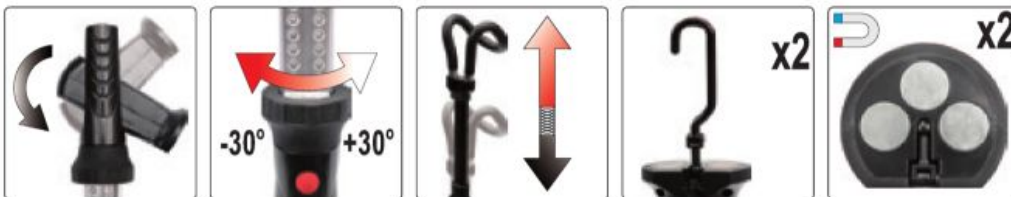

GB Workshop LED battery lamp
D LED Akku-handleuchte
PL Diodowa lampa warsztatowa akumulatorowa
RUS Светодиодная лампа LED

CZ Ruční svítlna LED
H LED szerelő lámpák
RO Lampa portabila cu acumulator leduri
F Lampe a LED rechargeable

I Lampada LED trasportabile per illuminazione di vani motore
E Linterna LED recargable
CN 引擎盖检修灯

SMD LED

36 LED	18 LED	36 LED	7.4V 2400mAh Li-Ion	230V~50Hz BATTERY CHARGER LADOWNIK
900 lm	CHARGING TIME ŁADOWNIA 5.5 h	WORK TIME CZAS PRACY 3.5 h	HOOK HAK	MAGNETIC



GB Workshop LED battery lamp
D LED Akku-handleuchte
PL Diodowa lampa warsztatowa akumulatorowa
RUS Светодиодная лампа LED

CZ Ruční svítlna LED
H LED szerelő lámpák
RO Lampa portabila cu acumulator leduri
F Lampe a LED rechargeable

I Lampada LED trasportabile per illuminazione di vani motore
E Linterna LED recargable
CN 引擎盖检修灯

SMD LED

12W	1200 lm	4000 K	230V~50Hz	CABLE HOSRN-F KABEL
5m	2x 1.0mm ²	POLYCARBONATE DIFFUSER KLEJ Z POKRYCIAMI	HOOK HAK	IP54

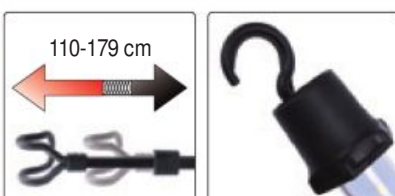

GB LED Flashlight
D LED Taschenlampe
PL Latarka LED
RUS Светодиодный фонарь
CZ LED svítilna
H LED zseblámpa
RO Lanterna cu LED
F LED lampe de torche

I Torcia LED
E Linterna LED
CN 手电筒

6W XPG3 500 lm 230 m
4 LIGHTING MODES (TWO DIRECTION) IPX7 6V 4x AA

POWER LED



YATO	W	lm	
YT-08564	6	500	6/24

DOUBLE BLISTER



GB LED Flashlight
D LED Taschenlampe
PL Latarka LED
RUS Светодиодный фонарь
CZ LED svítilna
H LED zseblámpa

RO Lanterna cu LED
F LED lampe de torche
I Torcia LED
E Linterna LED
CN 手电筒

10W XPL 1000 lm 350 m
3 LIGHTING MODES (TWO DIRECTION) ZOOM IPX4 6V 4x CR14

POWER LED



YATO	W	lm	
YT-08567	10	1000	8/16

DOUBLE BLISTER



GB LED Flashlight
D LED Taschenlampe
PL Latarka LED
RUS Светодиодный фонарь
CZ LED svítilna
H LED zseblámpa
RO Lanterna cu LED
F LED lampe de torche

I Torcia LED
E Linterna LED
CN 手电筒

3W XPE2 200 lm 120 m
ZOOM IPX4 3V 2x AA

POWER LED



YATO	W	lm	
YT-08565	3	200	8/64

DOUBLE BLISTER



GB LED Flashlight
D LED Taschenlampe
PL Latarka LED
RUS Светодиодный фонарь
CZ LED svítilna
H LED zseblámpa
RO Lanterna cu LED
F LED lampe de torche

I Torcia LED
E Linterna LED
CN 手电筒

5W XPG2 300 lm 150 m
ZOOM IPX4 4.5V 3x AAA

POWER LED



YATO	W	lm	
YT-08566	5	300	8/64

DOUBLE BLISTER



GB LED Flashlight
D LED Taschenlampe
PL Latarka LED
RUS Светодиодный фонарь
CZ LED svítilna
H LED zseblámpa
RO Lanterna cu LED
F LED lampe de torche
I Torcia LED

E Linterna LED
CN 手电筒

6W XPG3 500 lm
200 m 3 LIGHTING MODES (TWO DIRECTION) ZOOM IPX7 3.7V 2200mAh Li-ion USB BATTERY CHARGER (LADONARKA)

POWER LED



YATO	W	lm	
YT-08568	6	500	6/24

DOUBLE BLISTER



GB LED Flashlight
D LED Taschenlampe
PL Latarka LED
RUS Светодиодный фонарь
CZ LED svítilna
H LED zseblámpa
RO Lanterna cu LED

F LED lampe de torche
I Torcia LED
E Linterna LED
CN 手电筒

5W XTE 350 lm
150 m 4 LIGHTING MODES (TWO DIRECTION) ZOOM 3.7V 650mAh Li-ion USB BATTERY CHARGER (LADONARKA) IPX4

POWER LED



YATO	W	lm	
YT-08569	5	350	12/96

SLIDING CARD



GB LED Flashlight
D LED Taschenlampe
PL Latarka LED
RUS Светодиодный фонарь
CZ LED svítilna
H LED zseblámpa

RO Lanterna cu LED
F LED lampe de torche
I Torcia LED
E Linterna LED
CN 手电筒

3W 130 lm ZOOM IP64 1.5V 2x C WATER PROOF (ODPORNIA NA WODĘ)

POWER LED



YATO	W	lm	
YT-08577	3	130	12/48

SLIDING CARD



GB LED Flashlight
D LED Taschenlampe
PL Latarka LED
RUS Светодиодный фонарь
CZ LED svítilna
H LED zseblámpa

RO Lanterna cu LED
F LED lampe de torche
I Torcia LED
E Linterna LED
CN 手电筒

3W 100 lm ZOOM IP64 1.5V 2x AA WATER PROOF (ODPORNIA NA WODĘ)

POWER LED



YATO	W	lm	
YT-08575	3	100	12/72

SLIDING CARD



GB LED Flashlight
D LED Taschenlampe
PL Latarka LED
RUS Светодиодный фонарь
CZ LED svítilna
H LED zseblámpa

RO Lanterna cu LED
F LED lampe de torche
I Torcia LED
E Linterna LED
CN 手电筒

3W 110 lm ZOOM
IP64 1.5V AA WATER PROOF ODPORNÁ NA WODĘ

POWER LED



SLIDING CARD



YATO	W	lm	
YT-08572	3	110	12/72

GB LED Flashlight
D LED Taschenlampe
PL Latarka LED
RUS Светодиодный фонарь
CZ LED svítilna
H LED zseblámpa

RO Lanterna cu LED
F LED lampe de torche
I Torcia LED
E Linterna LED
CN 手电筒

3W 100 lm ZOOM IP64
1.5V AA WATER PROOF ODPORNÁ NA WODĘ

POWER LED



SLIDING CARD



YATO	W	lm	
YT-08571	3	100	24/96

GB LED Flashlight
D LED Taschenlampe
PL Latarka LED
RUS Светодиодный фонарь
CZ LED svítilna
H LED zseblámpa
RO Lanterna cu LED
F LED lampe de torche
I Torcia LED
E Linterna LED
CN 手电筒



9 LED 1.5V 3x AAA

SLIDING CARD



YATO	W	lm	
YT-08570			24/192

GB LED head lamp
D LED kopflampe
PL Diodowa lampka czołowa
RUS Налобный светодиодный фонарь
CZ LED montážní lampka - čelovka
H LED fejlámpa
RO Lampa cu LED
F Lampe frontale LED
I Lampada da testa
E Linterna de diodo
CN LED头灯



10W XM-L2 450 lm ZOOM 3 LIGHTING MODES 6V 4x AAA

POWER LED

DOUBLE BLISTER



YATO	W	lm	
YT-08591	10	450	6/24

GB LED head lamp
D LED kopflampe
PL Diodowa lampka czołowa
RUS Налобный светодиодный фонарь
CZ LED montážní lampka - čelovka
H LED fejlámpa
RO Lampa cu LED
F Lampe frontale LED
I Lampada da testa
E Linterna de diodo
CN LED头灯



3W 100 lm ZOOM WATER PROOF ODPORNÁ NA WODĘ 1.5V 3x AAA

POWER LED

SLIDING CARD



YATO	W	lm	
YT-08590	3	100	50/100

GB Automotive circuit tester
D KFZ Prüflampe
PL Wskaźnik elektryczny samochodowy
RUS Пробник напряжения автомобильный
CZ Zkoušečka napětí autoelektrikářská
H Autóvillamosági teszter
RO Tester pt. circuite auto
F Testeur de tension de voiture
I Tester elettrico per auto
E Indicador eléctrico de coche
CN 汽车测电笔

SLIDING CARD



CABLE KABEL 90 cm LED



6-24 V

YATO	
YT-2865	25/250

6-12 V

YATO	
YT-2866	10/100

- GB Number stamp
- D Nummernstempel
- PL Znaczniki cyfrowe
- RUS Клейма цифровые
- CZ Razidla číselná
- H Számbeütők
- RO Poansoane cu cifre
- F Chiffres à frapper
- I Punzoni marcatori
- E Marcadores de números
- CN 数字冲模



9
PCS

NUMBERS
NUMERY
0 - 9

1045
CARBON
STEEL

HRC
50-55

PLASTIC BOX
& COLOR SLEEVE

YATO	No (mm)	PCS packing	
YT-6854	6	9	20
YT-6855	8	9	18

- GB Letter stamp
- D Buchstabenstempel
- PL Znaczniki literowe
- RUS Клейма буквенные
- CZ Razidla písmenová
- H Betűbeütők
- RO Poansoane cu litere
- F Lettres à frapper
- I Punzoni marcatori
- E Marcadores de letras
- CN 字母冲模



27
PCS

LETTERS
LITERY
A - Z &

1045
CARBON
STEEL

HRC
50-55

PLASTIC BOX
& COLOR SLEEVE

YATO	No (mm)	PCS packing	
YT-6862	6	27	12
YT-6863	8	27	8

- GB Axle spindle rethreading set
- D Gewindereparatur Set Antriebswelle
- PL Zestaw do naprawy gwintów półosi
- RUS Набор для восстановления резьбы оси шруса
- CZ Souprava k opravě závitů hnacích hřídelí
- H Résztes menetjavító készlet főtengelyekhez
- RO Trusa pt. reparat filetele la planetare
- F Kit réparation filetage cardan
- I Kit di ripristino di filetti dei semiassi
- E Kit de herramienta de la reparación
- CN 传动轴螺杆修复组套



8
PCS

5/4"
32mm

M24x1.50; M24x2.00;
M22x1.00; M22x1.50;
M20x1.25; M20x1.50;
3/4x20 UNEF;
13/16x20 UNEF

BMC
& COLOR
SLEEVE



YATO	PCS packing
YT-17695	10

- GB Thread repair set
- D Reparatursatz für Gewinde
- PL Zestaw do naprawy gwintów
- RUS Набор для ремонта резьбы
- CZ Souprava na opravu závitů
- H Menetjavító készlet
- RO Set pt. reparare filete
- F Set d'helicoils
- I Kit di riparazione per filettature
- E Juego para reparar roscas
- CN 螺纹修复组套



HSS
4341

SS
STAINLESS STEEL
5% NIKELDINNA

88
PCS

YATO	size / rozmiar	
YT-1769	M6 x 1.0 x 10.8 mm	5/10
	M8 x 1.25 x 10.8 mm	
	M10 x 1.5 x 13.5 mm	



131
PCS

YATO	size / rozmiar	
YT-1763	M5 x 0.8 x 6.7 mm	5/10
	M6 x 1.0 x 10.8 mm	
	M8 x 1.25 x 10.8 mm	
	M10 x 1.5 x 13.5 mm	
	M12 x 1.75 x 16.3 mm	

- GB Wire threads
- D Spiraleinlagen für Gewindereparatur
- PL Wkłady spiralne do naprawy gwintów
- RUS Метчики и сверла для ремонта резьбы
- CZ Spirálové vložky na opravu závitů
- H Menetjavító betétek

- RO Insertii spirală pt. reparare filete
- F Helicoil
- I Inserti a spirale per riparazione
- E Elementos espirales para reparar roscas
- CN 不锈钢螺纹套

POLYBAG
WITH
HEADER



for / dla: YT-1763, YT-1769

SS
STAINLESS STEEL
5% NIKELDINNA



YATO	size / rozmiar	PCS packing	
YT-1764	M5 x 0.8 x 6.7 mm	20	50/250
YT-1765	M6 x 1.0 x 10.8 mm	20	50/250
YT-1766	M8 x 1.25 x 10.8 mm	20	50/200
YT-1767	M10 x 1.5 x 13.5 mm	15	25/100
YT-1768	M12 x 1.75 x 16.3 mm	10	25/100

- GB Dual foot tire gauge
- D Reifendruckprüfer
- PL Ciśnieniomierz do aut ciężarowych
- RUS Манометр для грузовых автомобилей
- CZ Tlakomer na nákladní auta
- H Nyomásmérő tehergépkocsikhoz
- RO Indicator de presiune pt. camioane
- F Manometre pneu pour camions
- I Manometro per automezzi
- E Manómetro de caomones
- CN 胎压表



0-15 bar

0-220 PSI

FOR TRUCKS
DO SAMOCHODÓW
CIĘŻAROWYCH

140
mm

SLIDING
CARD



YATO	PCS packing
YT-24301	25/100

GB Foot pump with gauge
D Fusspumpe
PL Pompka nożna z manometrem
RUS Насос ножный с манометром

CZ Nožní pumpa z manometrem
H Lábumpuľa nyomásmérővel
RO Pompă de picior cu manometru

F Pompe à pied avec manomètre
I Pompa a pedale con manometro

E Bomba de pierna con manometro
CN 打气筒

COLOR BOX



TWIN PISTON
PODWÓJNY TŁOK

YATO		
YT-7349	10	

YATO		
YT-7350	10	

GB Hand pump with manometer
D Hand-Luftpumpe mit Manometer
PL Pompka słupkowa z manometrem
RUS Насос ручной с манометром

CZ Pumpa z manometrem
H Kézi pumpa manométerrel
RO Pompa de mana cu manometru
F Pompe manuelle avec manomètre

I Pompa verticale con manometro
E Bomba de barrote con manometro
CN 带压力表打气筒



YATO		
YT-73521	3	

YATO		
YT-73530	3	

GB Air wedge
D Luft Keil
PL Poduszka montażowa
RUS Монтажная подушка для установки окон и дверей
CZ Zvedací vzduchové měchy
H Emelőpárna
RO Perna de aer
F Coussin élévateur
I Cuscino di montaggio
E Cojines elevadores
CN 门窗安装气囊

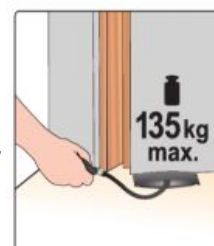

YATO		
YT-67380	24	

GB Oil jug
D Ölkanne
PL Nalewak warsztatowy
RUS Лейка пластиковая с крышкой для СТО
CZ Odměrka plastová - konev
H Olajbetöltő kanna
RO Recipient ulei
F Broc verseur avec couvercle
I Serbatoio
E Jarra con pitorro de aceite
CN 塑料油壶

POLYBAG

FOR AUTOMOTIVE FLUIDS
DO PŁYNÓW EKSPLOATACYJNYCH

FLEXI SPOUT
ELASTYCZNY LEJEK



YATO		
YT-06980	1	48
YT-06983	3	40
YT-06985	5	16

GB Oil jug
D Ölkanne
PL Nalewak warsztatowy
RUS Лейка пластиковая с крышкой для СТО
CZ Odměrka plastová - konev
H Olajbetöltő kanna
RO Recipient ulei
F Broc verseur avec couvercle
I Serbatoio
E Jarra con pitorro de aceite
CN 塑料油壶

POLYBAG

FOR AUTOMOTIVE FLUIDS
DO PŁYNÓW EKSPLOATACYJNYCH

PE



YATO		
YT-06987	10	8

GB Funnel
D Trichter
PL Lejek
RUS Воронка гибкая
CZ Nálevka
H Kétrészes tölszér
RO Pâlnie
F Entonnoir
I Imbuto
E Embudo
CN 漏斗



135mm PP

YATO	Ø (mm)	
YT-0694	135	192

GB Long funnel
D Trichter
PL Lejek dlugi
RUS Воронка гибкая
CZ Nálevka
H Kétrészes tölszér
RO Pâlnie
F Entonnoir
I Imbuto
E Embudo
CN 漏斗



120mm PP

YATO	L (mm)	Ø (mm)	
YT-0693	455	120	48

GB Operating fluids funnel
D Trichter
PL Lejek do płynów eksploatacyjnych
RUS Воронка гибкая
CZ Nálevka
H Kétrészes tölszér
RO Pâlnie
F Entonnoir
I Imbuto
E Embudo
CN 漏斗



100mm PP

YATO	Ø (mm)	
YT-0695	100	180

GB Operating fluids funnel
D Trichter
PL Lejek do płynów eksploatacyjnych
RUS Воронка гибкая
CZ Nálevka
H Kétrészes tölszér
RO Pâlnie
F Entonnoir
I Imbuto
E Embudo
CN 漏斗



240mm PP

YATO	Ø (mm)	
YT-0696	240	48

GB Fuel and oil funnel
D Trichter
PL Lejek do paliwa i oleju eksploatacyjnych
RUS Воронка гибкая
CZ Nálevka
H Kétrészes tölszér
RO Pâlnie
F Entonnoir pour essence et huile
I Imbuto
E Embudo
CN 漏斗



150mm PP

YATO	Ø (mm)	
YT-0692	150	30

GB Oil funnel
D Trichter
PL Lejek do oleju
RUS Воронка гибкая
CZ Nálevka
H Kétrészes tölszér
RO Pâlnie
F Entonnoir
I Imbuto
E Embudo
CN 漏斗



280mm PP

YATO	Ø (mm)	
YT-0697	280	48

GB Waste oil storage container
D Öl-Auffang-Kanister
PL Pojemnik zlewowy do oleju
RUS Контейнер отработанного масла
CZ Nádoba na použitý olej
H Fáradtolaj gyűjtő
RO Canistra colectare ulei
F Bidon de collecte d'huile
I Contenitore per la raccolta dell'olio
E Bidón cambio de aceite
CN 积油壶



PE

YATO	l	size / rozmiar (cm)	
YT-06995	8	60x33x11	4

GB Oil drain pan
D Ölwanne
PL Miska do oleju
RUS Миска для масла
CZ Miska na olej
H Fáradtolaj felfogó edény
RO Recipient pt. ulei
F Bol à l'huile
I Vaschetta per cambio olio
E Escudilla para aceite
CN 接油盆



PP

YATO	l	Ø (cm)	
YT-0699	7	37	48



PE

YATO	l	Ø (cm)	
YT-0716	10	37	6
YT-0717	15	42	4

GB Oil drainer
D Öleinfüllanlage
PL Zlewarka do oleju
RUS Устройство для слива масла
CZ Olejová nádrž s odsávním
H Fáradtolaj leszívó
RO Dispozitiv pt. schimbat ulei
F Récupérateur d'huile
I Scolapiatti dell'olio
E Decantador para aceite
CN 泄油器



75-155 cm PE

YATO	l	Ø (cm)	
YT-0718	20	42	1

WHITE CARTON BOX & COLOR LABEL



GB Farm jack
D Bauernhof-Jack
PL Podnośnik farmerski
RUS Домкрат механический, реечный

CZ Zvedák farm jack
H Hi-jack fogasléces off-road emelő
RO Cric mecanic tip off-road
F Vérins mécaniques commerciaux

I Farm jack - sollevatore di auto
E Elevación mecánicas comerciales
CN 农夫顶

GREY
CARTON BOX
& COLOR LABEL



700 mm
↓
130 mm

1070 mm
↓
130 mm

1350 mm
↓
155 mm

YATO	T		YATO	T		YATO	T	
YT-17260	3	1	YT-17261	3	1	YT-17262	3	1

GB Hydraulic bottle jack
D Hydraulischer Stempelwagenheber
PL Podnośnik hydrauliczny słupkowy
RUS Домкрат гидравлический
CZ Pístový zvedák hydraulický
H Hidraulikus emelő

RO Cric hidraulic
F Elévateur
I Cric idraulico a bottiglia
E Gato de embolo hidr.
CN 立式液压千斤顶

COLOR
BOX

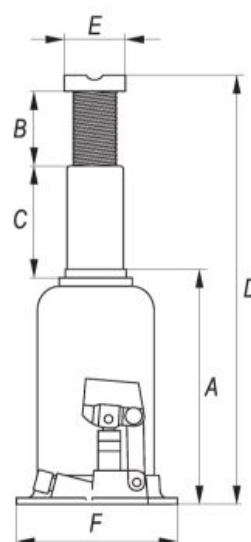
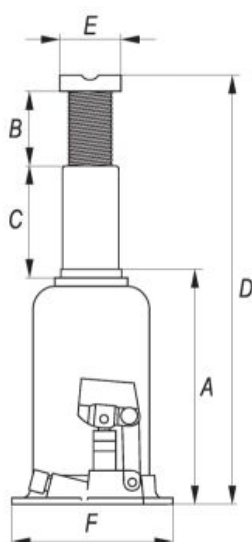

YATO	T	A (mm)	B (mm)	C (mm)	D (mm)	E (mm)	F (mm)	
YT-17000	2	181	48	164	345	25	88x92	6
YT-17001	3	194	60	180	374	27	92x100	6
YT-17002	5	216	60	180	413	29	96x110	4
YT-17003	8	230	80	147	457	32	103x118	2
YT-17004	10	230	80	150	460	36	110x123	2
YT-17005	12	230	80	155	465	40	116x134	2
YT-17006	15	230	82	150	462	43	140x134	2
YT-17007	20	242	60	150	452	45	144x150	2
YT-17008	32	285	-	180	465	69	190x152	1
YT-17009	50	300	-	180	480	83	218x176	1

YATO	T	A (mm)	B (mm)	C (mm)	D (mm)	E (mm)	F (mm)	
YT-17015	2	172	88	112	372	28	103x105	4
YT-1702	5	212	110	146	468	40	110x112	5
YT-17025	8	220	115	153	488	45	124x127.5	2
YT-1704	10	220	115	148	483	48	124x127.5	3
YT-17045	12	230	115	160	505	45	130x136	2
YT-1706	15	231	113	154	498	56	140x142	2
YT-1707	20	241	115	165	521	60	165x161	2
YT-17075	25	240	110	160	510	65	186x174	1
YT-1709	30	244	108	140	492	65	186x174	1

GB Two-piston hydraulic bottle jack
 D Hydraulischer Stempelwagenheber
 PL Podnośnik hydrauliczny
 stłpkowy dwutłpkowy

RUS Домкрат гидравлический
 CZ Pistový zvedák hydraulický
 H Hidraulikus emelő
 RO Cric hidraulic

F Elévateur deux niveaux
 I Cric idraulico a bottiglia
 E Gato de embolo hidr.
 CN 液压双级千斤顶

COLOR BOX

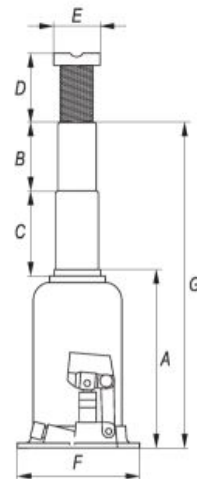
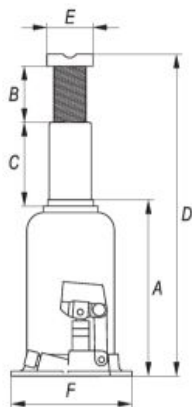

YATO	T	A (mm)	B (mm)	C (mm)	D (mm)	E (mm)	F (mm)	
YT-1711	5	222	146	138	500	41	130x136	2
YT-1713	10	128	63	38	223	47	160x165	2

YATO	T	A (mm)	B (mm)	C (mm)	D (mm)	E (mm)	F (mm)	G (mm)	
YT-1714	10	210	120	118	78	48	165x161	442	1
YT-1715	12	236	138	128	98	56	186x174.5	498	1

GB Hydraulic floor jack
 D Hydraulischer Rangierwagenheber
 PL Podnośnik hydrauliczny

RUS Домкрат гидравлический
 CZ Pistový zvedák hydraulický

H Krokodil emelő
 FO Cric tip crocodil
 F Elévateur hydraulique
 I Sollevatore idraulico

E Gato de embolo hidr.
 CN 卧式液压千斤顶



2t
 359 mm
 89 mm

BMC & COLOR SLEEVE



2.5t

465 mm
 100 mm
 QUICK LIFT
 SZYBKI PODNOŻENIE

DUAL PUMP
 PODWÓJNA POMPA

AI

ULTRA LIGHT

COLOR BOX



YATO	T	
YT-1720	2	1

YATO	T	
YT-17205	2.5	1



2.5t
 515 mm
 75 mm
 DUAL PUMP
 PODWÓJNA POMPA
 QUICK LIFT
 SZYBKI PODNOŻENIE

COLOR BOX



2.5t

457 mm
 89 mm

COLOR BOX



YATO	T	
YT-17207	2.5	1

YATO	T	
YT-1721	2.5	1

GB Hydraulic floor jack
D Hydraulischer Rangierwagenheber
PL Podnośnik hydrauliczny

RUS Домкрат гидравлический
CZ Pístový zvedák hydraulický

H Krokodil emelő
RO Cric tip crocodil
F Elévateur hydraulique
I Sollevatore idraulico

E Gato de embolo hidr.
CN 卧式液压千斤顶

COLOR BOX



3t

465 mm
130 mm

LOW PROFILE
NISKI PROFIL

3t

500 mm
145 mm

QUICK LIFT PEDAL
DŹWIGNIA SZYBKIEGO
PODNOŠZENIA



YATO	T	
YT-17211	3	1

YATO	T	
YT-17213	3	1

GB Vehicle ramp
D Auffahrrampe
PL Najazd samochodowy
RUS Мини эстакада для автомобиля
CZ Nájezd na auto
H Felhajtó rámpa
RO Rampa auto
F Rampe pour voiture
I Rampa per veicoli
E Rampa para coches
CN 运送顶



1 PC 1000 kg 815x305x200mm

POLYBAG

YATO	size / rozmiar (mm)	
YT-55670	815x305x200	2

GB Jack stand
D Unterstellböcke
PL Podstawka pod samochód
RUS Подставка под автомобиль
CZ Podstavec pod auto
H Gépkocsi alátét
RO Chituc de metal
F Paire de chandelles
I Coppia cavalletti
E Apoyos de coche
CN 千斤顶支架

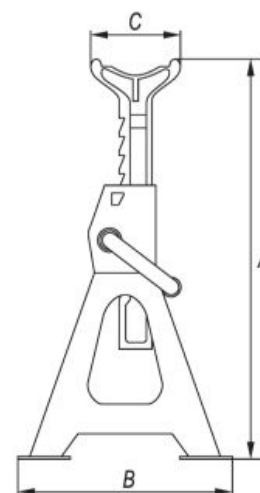

COLOR BOX

YATO	T	A (mm)	B (mm)	C (mm)	PCS packing	
YT-17310	2	265-415	190x165	77x40	2	1
YT-17311	3	280-420	182x201	85x29	2	1
YT-17312	6	382-600	258x285	100x29	2	1

GB Electronic battery charger
 D Elektronisches Ladegerät
 PL Prostownik elektroniczny
 RUS Электронное зарядное устройство
 CZ Elektronická nabíječka

H Elektronikus akkumulátortöltő
 RO Redresor electric
 F Chargeur de batterie voiture
 I Avviatore elettronico
 E Rectificador electrónico
 CN 蓄电池充电器



COLOR BOX



6 V	1 A	200 Ah	220-240V-50Hz	WET GEL AGM	MOKRY ZELOWY AGM	MICROPROCESSOR
12 V	4 A	max				

YATO	
YT-8300	8



12 V	4 A
5-120 Ah	220-240V-50Hz
WET GEL AGM	MOKRY ZELOWY AGM
MICROPROCESSOR	

HANGING COLOR BOX WITH WINDOW



6 V	4 A
12 V	
5-120 Ah	220-240V-50Hz
WET GEL AGM	MOKRY ZELOWY AGM
MICROPROCESSOR	

HANGING COLOR BOX WITH WINDOW



YATO	
YT-83031	30

YATO	
YT-83032	30

6 V	1 A
12 V	4 A
120 Ah max	220-240V-50/60Hz
WET GEL AGM	MOKRY ZELOWY AGM
MICROPROCESSOR	
LCD DISPLAY WITH WINDOW	
ALTERNATOR TEST TEST ALTERNATORA	STARTER TEST TEST ROZBUSZNIENIA



HANGING COLOR BOX

6 V	8 A
12 V	
5-200 Ah	220-240V-50Hz
WET GEL AGM	MOKRY ZELOWY AGM
MICROPROCESSOR	

COLOR BOX



YATO	
YT-83033	20

YATO	
YT-8301	8



12 V	12 A
6-200 Ah	220-240V-47-63Hz
MICROPROCESSOR	
WET MOKRY	

COLOR BOX



12 V	6-200 Ah
15 A	
220-240V-47-63Hz	WET GEL AGM
MICROPROCESSOR	
MOKRY ZELOWY AGM	

COLOR BOX



YATO	
YT-8302	8

YATO	
YT-8303	8

GB Battery charger with boost function
D Ladegerät mit Boost-Funktion
PL Prostownik z funkcją wspomagania ładowania
RUS Выпрямитель с функцией поддержки зарядки

CZ Nabíječky s funkci boost
H Akkumulátortöltő boost funkció
RO Redresor baterie cu functie boost
F Chargeur de batterie voiture support boost

I Carica batterie con boost
E Cargador de baterías arrancador boost
CN 充电器

COLOR BOX



230V~50Hz 12V 24V



16 A 120-240 Ah WET MOKRY

YATO YT-8304 2



25 A 170-350 Ah WET MOKRY

YATO YT-8305 2



15 A 10-300 Ah WET MOKRY AGM BOOST ROZRUCH 12V 75A MICROPROCESSOR

YATO YT-83051 2



30 A 50-600 Ah WET MOKRY AGM BOOST ROZRUCH 12V 145A MICROPROCESSOR

YATO YT-83052 2

GB Battery charger with engine start-up supporting function
D Ladegerät mit Starthilfe
PL Prostownik z funkcją wspomagania rozruchu
RUS Выпрямитель с функцией поддержки запуска
CZ Nabíječky s funkci startování motoru
H Akkumulátortöltő indító

RO Redresor cu functie de pomire de sprijn
F Chargeur de batterie voiture support demarrage
I Carica batterie carrellato con funzione di avviatore rapido
E Cargador de baterías arrancador
CN 充电器启动机

COLOR BOX



230V~50Hz WET MOKRY



12V 27 A START / ROZRUCH 300 A
24V 25 A START / ROZRUCH 240 A
20-600 Ah

YATO YT-83060 1



12V 32 A START / ROZRUCH 390 A
24V 31 A START / ROZRUCH 360 A
20-700 Ah

YATO YT-83061 1



12V 38 A START / ROZRUCH 540 A
24V 35 A START / ROZRUCH 450 A
20-800 Ah

YATO YT-83062 1

GB Jump starter power bank
D Multifunktions-Startgerät
PL Urządzenie rozruchowe wielofunkcyjne
RUS Портативное пусковое-зарядное устройство
CZ Power banka s možností nastartování auta
H Indító bikázó starter
RO Acumulator extern pt. pomire motor si incarcare
F Portable démarreur batterie voiture booster
I Dispositivo di avviamento multifunzione
E Coche portátil salto de arranque
CN 应急电源



COLOR BOX



200 A 400 A PEAK / ROZCIĄŻ
USB 5V / 2A
Li-Po
JUMP START ROZRUCH SILNIKA
S.O.S. FRONT LIGHTS (CZWARCIEMIEJOWY)



7500 mAh 2h QUICK CHARGING SYSTEM ŁADOWANIE

YATO YT-83080 20



9000 mAh 12V / 3.5A OUTPUT WYJŚCIE 3h QUICK CHARGING SYSTEM ŁADOWANIE

YATO YT-83081 10

- GB Power inverter
- D Spannungswandler
- PL Przetwornica napięcia
- RUS Автомобильный инвертор
- CZ Měnič napětí
- H Feszültség átalakító
- RO Convertor de tensiune
- F Convertisseur de tension
- I Inverter di corrente
- E Convertidor de voltaje
- CN 逆变器

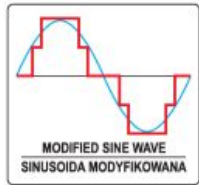

12 V INPUT WEJŚCIE

220-240 V-50 Hz OUTPUT WYJŚCIE

THERMAL PROTECTION

LOW VOLTAGE LEVEL SIGNAL

OVERPROTECTION

TEMPERATURE

LOW VOLTAGE LEVEL SIGNAL

OVERPROTECTION

TEMPERATURE



500 W

1000 W PEAK SZCZYT.

800 W

1600 W PEAK SZCZYT.

YATO		
YT-81490	12	

YATO		
YT-81491	12	

- GB Jumpstart wires
- D Starterkabel
- PL Przewody rozruchowe
- RUS Пусковые провода
- CZ Startovací kabely
- H Indító kábelek
- RO Cabluri demarare
- F Câbles de démarrage
- CN 输出线
- I Cavi carica batteria
- E Cables de arranque

WINDOW BAG WITH ZIPPER

2.5m



YATO	rated load / obciążenie nominalne (A)	
YT-83151	200	12

YATO	rated load / obciążenie nominalne (A)	
YT-83152	400	12

YATO	rated load / obciążenie nominalne (A)	
YT-83153	600	12

- GB Analogue battery tester
- D Analoges Batterieprüfgerät
- PL Tester akumulatorów analogowy
- RUS Аналоговый тестер аккумуляторов
- CZ Analogový tester akumulátorů
- H Analóg akkuteszter
- RO Tester acumulatori analog
- F Testeur de charge batterie
- I Tester analogico per batteria
- E Tester analógico para acumuladores
- CN 电池测试器

COLOR BOX

6 V

12 V

CCA 200-1000 A



YATO		
YT-8310		10

- GB Digital battery tester
- D Digitales Batterieprüfgerät
- PL Tester akumulatorów cyfrowy
- RUS Цифровой тестер аккумуляторов
- CZ Digitální tester akumulátorů
- H Digitális akkuteszter
- RO Tester acumulatori digital
- F Testeur digital de charge batterie
- I Tester digitale per batteria
- E Tester digital para acumuladores
- CN 电池测试器

COLOR BOX

12 V

LED DISPLAY

CCA 150-1400 A



YATO		
YT-8311		10

- GB Battery tester
- D Batterieprüfgerät
- PL Tester akumulatorów
- RUS Тестер аккумуляторов
- CZ Tester akumulátorů
- H Akkuteszter
- RO Tester acumulatori
- F Testeur électronique de charge batterie et alternateur
- I Tester per batteria
- E Tester para acumuladores
- CN 电池测试器

DOUBLE BLISTER

12 V

BATTERY TEST

TEST AKUMULATORA

ALTERNATOR TEST

TEST ALTERNATORA



YATO		
YT-83101		12/72

- GB Refractometer
- D Refraktometer
- PL Refraktometr
- RUS Рефрактометр
- CZ Refraktometer
- H Fagyálló fokoló
- RO Refractometru
- F Réfractomètre
- I Rifrattometro
- E Refractometro
- CN 冰点仪

+

+

+



PLASTIC BOX & COLOR SLEEVE

YATO		
YT-06722		20

- GB Chain block
- D Kettenzug Flaschenzug
- PL Wyciągarka łańcuchowa
- RUS Таль цепная
- CZ Zvedák řetězový
- H Lánco csigasor emelő
- RO Scripete cu lant
- F Treuil à chaîne
- I Paranco a catena
- E Cabría de cadena
- CN 手拉葫芦



3m

GREY
CARTON BOX
& COLOR LABEL

YATO	max. load capacity / max. ładowność (kg)	
YT-58950	500	1
YT-58951	1000	1
YT-58953	2000	1
YT-58954	3000	1
YT-58955	5000	1

PLYWOOD BOX
& COLOR LABEL

YATO	max. load capacity / max. ładowność (kg)	
YT-58957	10000	1

- GB Electric hoist
- D Elektro-Seilwinde
- PL Elektryczny wciągnik linowy
- RUS Электрическая канатная лебедка
- CZ Elektrický naviják kladkostroj
- H Elektromos csőrő
- RO Troliu electric cu cablu
- F Treuil électrique à corde
- I Verricello elettrico
- E Cabría eléctrica de cuerdas
- CN 电动葫芦



COLOR
BOX

YATO	max. lifting capacity / max. udźwign (kg)	
YT-58962	750	1
YT-58964	1500	1
YT-58966	3000	1
YT-58967	6000	1

YATO	max. lifting capacity / max. udźwign (kg)	
YT-58968	9000	1

YATO	max. lifting capacity / max. udźwign (kg)	
YT-5901	125 kg / 250 kg	2
YT-5902	150 kg / 300 kg	2
YT-5904	250 kg / 500 kg	2
YT-5905	300 kg / 600 kg	2

230V~50Hz STOP STOP

500W 125 kg 250 kg

$L_{pA} \leq 70$ dB;
 $L_{wA} \leq 85$ dB

8 min max. 11m 4 min max. 5.5m

550W 150 kg 300 kg

$L_{pA} \leq 70$ dB;
 $L_{wA} \leq 85$ dB

8 min max. 11m 4 min max. 5.5m

900W 250 kg 500 kg

$L_{pA} \leq 70$ dB;
 $L_{wA} \leq 85$ dB

8 min max. 11m 4 min max. 5.5m

1050W 300 kg 600 kg

$L_{pA} \leq 70$ dB;
 $L_{wA} \leq 85$ dB

8 min max. 11m 4 min max. 5.5m

GB Rope winch
D Handseilwinde
PL Wyciągarka linowa

RUS Канатная лебедка
CZ Lanové vyťahovací zařízení
H Drótköteles csőrlő

RO Troliu cu cablu orizontal
F Treuil à corde
I Paranco a corda

E Cabria de cuerdas
CN 绳索拉紧器

COLOR BOX

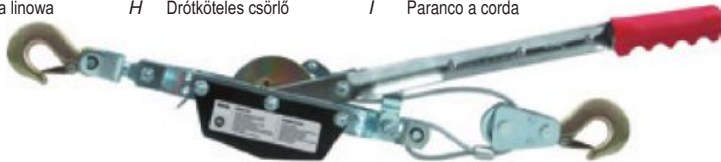

1000 daN

YATO	daN	L (m)	Ø (mm)	Box
YT-5911	1000	3	5	6



1300 daN

YATO	daN	L (m)	Ø (mm)	Box
YT-5913	1300	3	5	6



1500 daN

YATO	daN	L (m)	Ø (mm)	Box
YT-5914	1500	3	6	3

GB Transmission jack
D Hydraulische Getriebeheber
PL Podnośnik skrzyni biegów
RUS Домкрат для коробки передач
CZ Pojízdný zvedák motorů a převodovek
H Sebességváltó emelő tartó
RO Cric cutii de viteza
F Levage des moteurs et des boîtes de vitesses
I Sollevatore scatola del cambio
E Motor de transmisión telescópica
CN 坡道

500 kg max.

1945 mm
1140 mm

PRECISION VALVE
PRECYZYJNY ZAWÓR

GB Shop crane
D Werkstattkran
PL Żuraw warsztatowy
RUS Кран подкатной гидравлический
CZ Hydraulický jeřáb
H Motorkiemelő zsríár

RO Girafa pt. scos motor
F Grue d'atelier
I Gru idraulica
E Grúa hidráulica para motores
CN 吊机

GREY CARTON BOX & COLOR LABEL



210cm max



1000 kg

YATO	Box
YT-55556	1



230cm max



2000 kg

YATO	Box
YT-55557	1



GREY CARTON BOX & COLOR LABEL

YATO	Box
YT-55600	1

GB Shop press
D Hydraulische
Werkstattpresse
PL Prasa hydrauliczna

RUS Гидравлический пресс
CZ Hydraulický lis
H Hidraulikus prés
RO Presa hidraulică

F Presse hydraulique
I Pressa idraulica
E Prensa de hidráulica
CN 压力机

GREY CARTON BOX
& COLOR LABEL

12t

0-695
mm

400
mm



20t

0-695
mm

490
mm



30t

0-795
mm

520
mm



YATO
YT-55580

1

YATO
YT-55581

1

YATO
YT-55582

1

GB Engine suspension beam
D Aufnahmevorrichtung des Motors
PL Belka do podwieszenia silnika
RUS Балка для вывешивания
двигателя
CZ Nosník k zavěšení motoru
H Motorfelfüggesztő gerenda

RO Grindă pt. suspendarea motorului
F Poutre de suspension de moteur
I Fascio sospensione del motore
E La viga para suspender el motor
CN 发动机平衡架

500kg
max. 150
cm

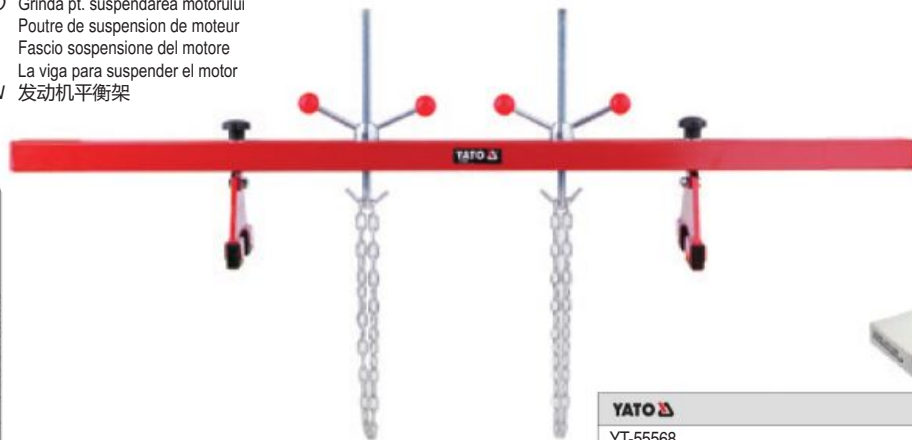
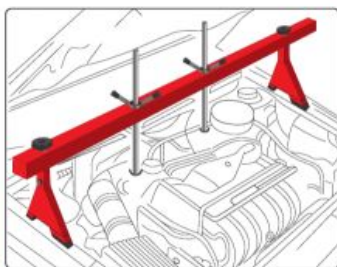

WHITE CARTON BOX
& COLOR LABEL



YATO
YT-55568

1

GB Crane crossbeam
D Traverse zum Kran
PL Traversa do żurawia
RUS Траверса для крана
CZ Jeřábová traverza
H Traverz a zsiráf
emelőhöz
RO Traversă pt. macara
F Balancier pour
grue d'atelier
I Traverse per gru
E Viga transversal
para grua
CN 平衡器

680
kg 315
mm



WHITE CARTON BOX
& COLOR LABEL

YATO
YT-55565

1

GB Engine stand
D Motorständer
PL Stojak do silnika
RUS Стойка для ремонта
двигателя
CZ Stojan na motor
H Motorszerelő állvány

RO Suport pt. motor
F Support moteur
I Cavalletto per motore
E Soporte de motor
CN 发动机支架

450
kg 4
360°



GREY
CARTON BOX
& COLOR LABEL



YATO
YT-55570

1

GB Self locking nuts assortment
D Sortiment Mutter metrisch mit Sicherheit
PL Zestaw nakrętek metrycznych z zabezpieczeniem
RUS Набор гаек самоконтрящиеся, с нейлоновой вставкой
CZ Šestihranné matice s bezpečností

H Nuts metrikus menet biztonságai
RO Set piulite autoblocante
F Hex écrou set avec la sécurité
I Set di autobloccanti metrica dadi
E Porcas rosca métrica com a segurança
CN 146件套螺母组套

PLASTIC HANGING BOX
146 PCS
 INSERT LOCK ZABEZPIECZENIE
 MIX SIZE ROZMIAŃCÓW



M4, M5, M6, M8, M10, M12

YATO
 YT-06774 5/20

GB Metric nuts assortment
D Sortiment Mutter metrisch
PL Zestaw nakrętek metrycznych
RUS Набор гаек
CZ Šestihranné matice
H Nuts metrikus menet

RO Set piulite
F Hex écrou set
I Set di metrica dadi
E Porcas rosca métrica
CN 300件套螺母组套

PLASTIC HANGING BOX
300 PCS
 MIX SIZE ROZMIAŃCÓW



M3, M4, M5, M6, M8, M10

YATO
 YT-06772 5/20

GB Stainless steel nuts assortment
D Sortiment Mutter metrisch rostfrei
PL Zestaw nakrętek metrycznych nierdzewnych
RUS Набор гаек шестигранных нержавеющей
CZ Nerezové oceli šestihřanné matice

H Nuts metrikus menet rozsdamentes
RO Set piulite inox
F Hex écrou set inoxydable
I Set di acciaio inossidabile metrica dadi
E Rosca métrica tuerca inoxidable
CN 300件套不锈钢螺母组套

PLASTIC HANGING BOX
300 PCS
 MIX SIZE ROZMIAŃCÓW
 SS STAINLESS STEEL 316L NERDZEWNA



M3, M4, M5, M6, M8, M10

YATO
 YT-06773 5/20

GB Hex nut with top assortment
D Sortiment Mutter metrisch geschlossen
PL Zestaw nakrętek metrycznych kolpakowych
RUS Набор гаек колпачковых
CZ Šestihranné matice zavřeno
H Nuts metrikus menet zárt

RO Set piulite inchise
F Hex écrou set fermé
I Set di dadi campana-metrica
E Rosca métrica tuercas cerrado
CN 150件套不锈钢螺母组套

PLASTIC HANGING BOX
150 PCS
 MIX SIZE ROZMIAŃCÓW



M3, M4, M5, M6, M8, M10

YATO
 YT-06775 5/20

GB Metric wing nut assortment
D Sortiment Flügelmuttern
PL Zestaw nakrętek motylkowych
RUS Набор гаек типа «барашек»
CZ Křídlaté matice lisované
H Szárnyas anya
RO Set piulite fluture
F Assortiment d'écrous papillon
I Set di metrica dadi
E Tuercas con orejas
CN 蝶形螺母



PLASTIC HANGING BOX



150 PCS
 MIX SIZE ROZMIAŃCÓW
 METRIC METRYCZNE



M4, M5, M6, M8, M10

YATO
 YT-06776 25

GB Aluminium washer set
D Aluminium Dichtring Sortiment
PL Zestaw podkładek aluminiowych
RUS Набор алюминиевых шайб

CZ Sada hliníkových podložek
H Réz alátét készlet
FO Set saibe aluminiu
F Assortiment de joints en aluminium

I Set di rondelle in alluminio
E Juego de arandelas de aluminio para taponos
CN 300件套铝垫片

PLASTIC BOX



300 PCS
MIX SIZE RODZIMÓW
METRIC METRYCZNE
Al



10x 5x8x1.0 mm	10x 8x14x1.5 mm	10x 12x16x1.0 mm	10x 14x20x1.5 mm	10x 18x24x1.5 mm	10x 22x29x1.5 mm
10x 6x10x1.0 mm	10x 8x14x1.5 mm	10x 12x16x1.5 mm	10x 16x20x1.5 mm	10x 20x24.5x1.5 mm	10x 24x28x1.5 mm
10x 6x12x1.0 mm	10x 10x14x1.0 mm	10x 12x16x1.5 mm	10x 16x20x1.5 mm	10x 20x24.5x2.0 mm	10x 24x28x2.0 mm
10x 6x12x1.0 mm	10x 10x14x1.5 mm	10x 13x16x1.5 mm	10x 16x22x1.5 mm	10x 19x26x2.0 mm	10x 26x34x2.0 mm
10x 8x14x1.0 mm	10x 10x16x1.0 mm	10x 14x18x1.5 mm	10x 18x22x1.5 mm	10x 22x27x1.2 mm	10x 28x36x2.0 mm

5x9x1.0 mm, 8x14x1.5 mm, 12x16x1.0 mm, 14x20x1.5 mm, 18x24x1.5 mm, 22x29x1.5 mm, 6x10x1.0 mm, 9x14x1.0 mm, 12x16x1.5 mm, 14x20x2.0 mm, 20x24.5x1.5 mm, 24x29x1.5 mm, 6x12x1.0 mm, 10x14x1.0 mm, 12x18x1.5 mm, 16x20x1.5 mm, 20x24.5x0.8 mm, 24x32x2.0 mm, 8x12x1.0 mm, 10x14x1.5 mm, 13x18x1.0 mm, 16x22x1.5 mm, 19x26x2.0 mm, 26x34x2.0 mm, 8x14x1.0 mm, 10x16x1.0 mm, 14x18x1.5 mm, 18x22x1.5 mm, 22x27x1.0 mm, 28x36x2.0 mm

YATO
YT-06865 5/20

GB Copper washer set
D Kupfer Dichtring Sortiment
PL Zestaw podkładek miedzianych
RUS Набор колец медных

CZ Podložky měděné těsnící
H Réz tömítés készlet
FO Saibe din cupru
F Patins en cuivre

I Set di spessori
E Arandelas de cobre
CN 件套紫铜垫片

PLASTIC HANGING BOX



150 PCS
MIX SIZE RODZIMÓW
Cu



5x10x1 mm 10 pcs	8x11x1 mm 10 pcs	11x17x1.5 mm 10 pcs	12.5x20x1.5 mm 10 pcs	15x20x2 mm 10 pcs	16.5x24x2 mm 10 pcs
6x10x1 mm 10 pcs	10x16x1 mm 10 pcs	14x18x1 mm 10 pcs	14x20x1.5 mm 10 pcs	16x22x2 mm 10 pcs	17.5x24x2 mm 10 pcs
7x10x1 mm 10 pcs	10.5x17x1.5 mm 10 pcs	12x20x1.5 mm 10 pcs	14x20x1.5 mm 10 pcs	16x22x2 mm 10 pcs	17.5x24x2 mm 10 pcs

5x10x1.0 mm, 6x10x1.0 mm, 7x10x1.0 mm, 8x11x1.0 mm, 10x16x1.0 mm, 10.5x17x1.5 mm, 11x17x1.5 mm, 14x18x1.0 mm, 12x20x1.5 mm, 12.5x20x1.5 mm, 14x20x1.5 mm, 15x20x2.0 mm, 16x22x2.0 mm, 16.5x24x2.0 mm, 17.5x24x2.0 mm

YATO
YT-06871 5/20

GB Copper washer set
D Kupfer Dichtring Sortiment
PL Zestaw podkładek miedzianych
RUS Набор колец медных

CZ Podložky měděné těsnící
H Réz tömítés készlet
FO Saibe din cupru
F Patins en cuivre

I Set di spessori
E Arandelas de cobre
CN 件套紫铜垫片

PLASTIC BOX



300 PCS
MIX SIZE RODZIMÓW
METRIC METRYCZNE
SOFT TYPE MIEKKI MATERIAŁ
Cu



10x 5x8x1.0 mm	10x 8x14x1.5 mm	10x 12x16x1.0 mm	10x 14x20x1.5 mm	10x 18x24x1.5 mm	10x 22x29x1.5 mm
10x 6x10x1.0 mm	10x 8x14x1.0 mm	10x 12x16x1.5 mm	10x 14x20x2.0 mm	10x 20x24.5x1.5 mm	10x 24x28x1.5 mm
10x 6x12x1.0 mm	10x 10x14x1.0 mm	10x 12x16x1.5 mm	10x 16x20x1.5 mm	10x 20x24.5x2.0 mm	10x 24x28x2.0 mm
10x 6x12x1.0 mm	10x 10x14x1.5 mm	10x 13x16x1.5 mm	10x 16x22x1.5 mm	10x 19x26x2.0 mm	10x 26x34x2.0 mm
10x 8x14x1.0 mm	10x 10x16x1.0 mm	10x 14x18x1.5 mm	10x 18x22x1.5 mm	10x 22x27x1.2 mm	10x 28x36x2.0 mm

5x9x1.0 mm, 8x14x1.5 mm, 12x16x1.0 mm, 14x20x1.5 mm, 18x24x1.5 mm, 22x29x1.5 mm, 6x10x1.0 mm, 9x14x1.0 mm, 12x16x1.5 mm, 14x20x2.0 mm, 20x24.5x1.5 mm, 24x29x1.5 mm, 6x12x1.0 mm, 10x14x1.0 mm, 12x18x1.5 mm, 16x20x1.5 mm, 20x24.5x0.8 mm, 24x32x2.0 mm, 8x12x1.0 mm, 10x14x1.5 mm, 13x18x1.0 mm, 16x22x1.5 mm, 19x26x2.0 mm, 26x34x2.0 mm, 8x14x1.0 mm, 10x16x1.0 mm, 14x18x1.5 mm, 18x22x1.5 mm, 22x27x1.0 mm, 28x36x2.0 mm

YATO
YT-06872 5/20

GB Copper gasket & oil drain plug assortment
D Ölblechschraube Kupfer Schrauben und O-Ringe
PL Zestaw podkładek miedzianych i korków spustowych
RUS Набор медных шайб и сливных пробок поддона двигателя

CZ Sada měděných podložek a zátek pro olejové výpustě
H Olajteknő csavar és rézalátét készlet
RO Set busoane baie ulei
F Boulons de carter d'huile & assortiment bagues

I Set di rondelle in rame a spine
E Tornillos y juntas para tapon de carter
CN 534PC油封

PLASTIC BOX



534 PCS

MIX SIZE RODMÁRKA

Cu



 50x 6 mm	 50x 8 mm	 50x 10 mm	 50x 12 mm	 50x 13 mm	 50x 14 mm
 50x 15 mm	 50x 16 mm	 50x 16 mm	 50x 20 mm	 5x M6x1	 5x M10x1
 5x M12x1.5	 5x G1/4	 5x M14x1.5	 5x M16x1.5	 5x M18x1.5	 5x M20x1.5

6 mm, 8 mm, 10 mm, 12 mm, 13 mm, 14 mm, 15 mm, 16 mm, 18 mm, 20 mm;
 M8x1.0, M10x1.0, M12x1.5, M14x1.5, M16x1.5, M18x1.5, M20x1.5; G1/4

YATO
 YT-06864 10

GB Bodywork nuts & screws assortment
D Sortiment Karosseriemuttern mit Schrauben
PL Zestaw wkrętów i podkładek do karoserii
RUS Набор саморезов и металлических клипс для кузовных работ
CZ Tělo matice a šroub kit

H Karosszéria csavar és anya készlet
RO Set asamblare clema / holsuruburi
F Assortiment de vis et d'érous cage
I Set viti e rondelle al corpo
E Body kit tornillo
CN 170件套螺丝U型圈组套

PLASTIC HANGING BOX

170 PCS

MIX SIZE RODMÁRKA



M3, M4, M5, M6;
 M3x8 mm, M4x16 mm, M5x12 mm, M6x20 mm

YATO
 YT-06780 5/20

GB Clevis pin assortment
D Bolzen mit Kopf
PL Zestaw sworzni z łbem i otworem
RUS Набор штифтов с отверстиями под шплинт

CZ Čepý s hlavou
H Csapszeget kit
RO Set bolturi pt. securizare
F Axe de chape
I Set di perni con testa e il foro
E Kit de pasador de horquilla
CN 60PC销柱

PLASTIC HANGING BOX

60 PCS

MIX SIZE RODMÁRKA

5-12 mm



5x25 mm, 6x25 mm, 6x30 mm, 6x40 mm, 6x45 mm, 6x50 mm, 6x60 mm, 6x65 mm, 8x25 mm, 8x30 mm, 8x40 mm, 8x45 mm, 8x50 mm, 8x60 mm, 8x65 mm, 8x70 mm, 10x25 mm, 10x40 mm, 10x50 mm, 12x40 mm, 12x50 mm

YATO
 YT-06786 4/16

GB Metric nuts & bolts assortment
D Metric Mutter und Bolzen Sortiment
PL Zestaw śrub, nakrętek, podkładek i wkrętów

RUS Набор винты / гайки / болты / шайбы
CZ Sada šroubů, matic, podložek
H Csavarkészlet
RO Set suruburi / piulite

F Ecrous et boulons métrique assortiment
I Set di viti, dadi, rondelle e viti
E Tuercas y tornillos métrica surtido
CN 347PC机丝自攻

PLASTIC HANGING BOX



347 PCS

MIX SIZE RODMÁRKA



 32x 3 x 12 mm	 26x 3 x 20 mm	 13x 5 x 24 mm	 43x 2.5 x 12 mm	 32x 3 x 19 mm	 10x 4 x 24 mm
 59x M5	 19x M6	 19x M5 x 25 mm	 24x M5 x 20 mm	 11x M6 x 20 mm 10x M6	 49x M5

3x12 mm, 3x20 mm, 5x24 mm; 2.5x12 mm, 3x19 mm, 4x24 mm;
 M5, M6; M5x20 mm, M5x25 mm, M6x20 mm;
 M5, M6

YATO
 YT-06771 6/24

GB Grease nipple set
D Schmiernippel
PL Zestaw smarowniczek
RUS Набор масленок

CZ Sady mazacích hlavíc
H Zsírözomb (zsírözöfej) készlet
RO Set gresoare metalice
F Set de graisseurs métriques

I Set grasso capezzoli
E Engrasador
CN 件套黃油嘴組套

PLASTIC
HANGING BOX



110
PCS

METRIC
METRYCZNE



M6x1	M6x1 45°	M8x1	M8x1 90°	M10x1 90°	M10x1
	 5 pcs	 10 pcs	 5 pcs	 5 pcs	 10 pcs
	 5 pcs	 5 pcs	 5 pcs		
60 pcs					

YATO

YT-06888



5/20

M6x1, M6x1 45°, M6x1 90°, M8x1, M8x1 45°, M8x1 90°, M10x1, M10x1 45°, M10x1 90°

GB Spring assortment
D Schraubenfeder Sortiment
PL Zestaw sprężynek
RUS Набор пружинок оцинкованных

CZ Sada pružin
H Rugó készlet
RO Arcuri tensiune
F Assortiment ressorts

I Set di molle
E Caja surtido de de resortes
CN 件套彈簧組套

PLASTIC
HANGING BOX



200
PCS

MIX
SIZES
ROZMIAŘENÍ



10 pcs 7.0 x 12.0 mm 5.0 x 20.0 mm	6 pcs 8.5 x 18.0 mm 8 pcs 8.5 x 28.5 mm	12 pcs 8.5 x 47.0 mm 8.0 x 44.5 mm	8 pcs 4.0 x 44.0 mm 9.0 x 35.0 mm	10 pcs 5.5 x 18.0 mm
10 pcs 8.5 x 10.0 mm 5.5 x 25.0 mm	12 pcs 8.5 x 18.0 mm	12 pcs 7.0 x 51.0 mm 4.0 x 70.0 mm	10 pcs 7.0 x 36.0 mm	10 pcs 8.5 x 36.0 mm 7.8 x 18.0 mm

YATO

YT-06875



5/20

GB Aluminium rivet assortment
D Aluminium Blindnieten
Sortiment
PL Zestaw aluminiowych nitów
zrywalnych
RUS Набор заклепок
CZ Sada hliníkové nitý

H Csöves alumínium szegecsék
RO Set popnitr
F Rivets tubulaires en aluminium
I Set di rivetto alluminio
E Remaches tubulares
de aluminio
CN 400件套铆钉组套

PLASTIC
HANGING
BOX

400
PCS

MIX
SIZES
ROZMIAŘENÍ

AI



GB Hitch pin assortment set
D Sortiment Federsplinte
PL Zestaw zawleczek sprężystych
RUS Набор шплинтов с фиксацией
CZ Pružinové závlačky
H Rugós csap

RO Set sigurante securizare
F Assortiment goupilles beta
I Set di spine elastiche
E Pasadores surtido beta
CN 150PC R型销

PLASTIC
HANGING
BOX

150
PCS

6
SIZES
ROZMIAŘENÍ



2.4, 3.2, 4.0, 4.8 mm



2.4x31 mm, 2x33 mm, 2x40 mm,
2.8x42 mm, 3.5x45 mm, 4x75 mm

YATO

YT-36420



5/20

YATO

YT-06883



6/24

GB Splint pin assortment
D Splinte Sortiment
PL Zestaw zawleczek prostych
RUS Набор шплинтов
CZ Set závlačky
H Sasszeg készlet

RO Cuie spintecate mici
F Goupilles - goupille fendue
I Set di perni
E Dividir cotter pinos
CN 件套开口销组套

PLASTIC HANGING BOX

555 PCS

MIX SIZE RODMARROW



1.6x25 mm, 2.4x25 mm, 2.4x38 mm,
3.2x32 mm, 3.2x50 mm, 4.0x64 mm

YATO YT-06873 5/10

GB Splint pin assortment
D Splinte Sortiment
PL Zestaw zawleczek prostych
RUS Набор шплинтов
CZ Set závlačky
H Sasszeg készlet

RO Cuie spintecate mici
F Goupilles - goupille fendue
I Set di perni
E Dividir cotter pinos
CN 件套开口销组套

PLASTIC HANGING BOX

1000 PCS

MIX SIZE RODMARROW



1.5x25 mm, 2.4x25 mm, 2.4x38 mm,
3.0x32 mm, 3.0x50 mm, 4.0x60 mm

YATO YT-06885 12

GB E-ring circlips assortment
D Sortiment E-Sicherungsringe
PL Zestaw zawleczek typu „E”
RUS Набор Э-образных стопорных колец
CZ Otevření pojistný kroužek
H „E” klip választék készlet

RO Set inele seger alezaj
F „E” clip assortment kit
I Set di spine tipo „E”
E E-ring anillo de retención variedad
CN 卡簧

PLASTIC HANGING BOX

300 PCS

1.5-22 mm



1.5 mm, 3 mm, 5 mm, 6 mm, 10 mm,
12 mm, 15 mm, 19 mm, 22 mm

YATO YT-06884 25

GB Linch-pins assortment
D Klappsplint Sortiment
PL Zestaw zawleczek z kółkiem
RUS Набор шплинтов с кольцом
CZ Kolik pojistny
H Rugos biztosítoszeg készlet

RO Set pini pt. securizare
F Assortiment goupille clip
I Set di perni dalla ruota
E Pasador clip
CN 50件套弹性销组套

PLASTIC HANGING BOX

50 PCS

MIX SIZE RODMARROW



Ø 4.5x36 mm, Ø 6.0x45 mm,
Ø 8.0x45 mm, Ø 11.0x45 mm

YATO YT-06787 6/12

GB Hose clamp assortment
D Schlauchschelle Sortiment
PL Zestaw obejm ślimakowych
RUS Набор хомутов
CZ Spony stahovac na hadice sada
H Tömölbilincs csőszerelés szett
RO Coliere furtun

F Colliers de serrage universels
I Fascetta assortimento
E Manguera helicoidal instalación de tuberías abrazadera conjunto
CN 26件套喉箍

PLASTIC HANGING BOX

26 PCS

MIX SIZE RODMARROW

16-40 mm



16, 22, 25, 28, 35, 40 mm

YATO YT-06782 5/20

GB External / internal circlip assortment
D Aussen / Innen seegerring sortiment
PL Zestaw pierścieni Segera wewnętrznych / zewnętrznych
RUS Набор стопорных колец
CZ Sada vnitřní / vnější kroužky
H Állítsa belső / külső seeger-gyűrű

RO Set inele seger arbore
F Externe / interne assortiment de circlip
I Set all'esterno / all'interno degli anelli Segera
E Sortimento freio externo / interno
CN 225件套外挡圈

PLASTIC HANGING BOX

225 PCS

MIX SIZE RODMARROW

EXTERNAL / INTERNAL ZEWNETRZNE / WEWNETRZNE



INTERNAL / WEWNETRZNE: Ø 11, 13, 14, 16, 19, 20 mm
EXTERNAL / ZEWNETRZNE: Ø 6, 8, 9, 11, 13, 14, 16, 19, 20, 22, 25, 32 mm

YATO YT-06882 5/20

- GB** External circlip assortment
D Aussen-seegerring-sortiment
PL Zestaw pierścieni segera zewnętrznych
RUS Кольца стопорные внешние
CZ Sada pojistné kroužky
H Külső seeger-gyűrű készlet

- RO** Set agrafe
F Set de circlips ext.
I Set all'esterno degli anelli Segera
E Anillos seeger para agujeros exteriores
CN 件套外挡圈组套

PLASTIC HANGING BOX

300 PCS

EXTERNAL
ZEMNETRZNE



Ø 3, 4, 5, 6, 8, 9, 11, 12, 13, 14, 15, 19, 20, 22, 25, 26, 28, 32 mm



YT-06880



5/20

- GB** Internal circlip assortment
D Innen-seegerring-sortiment
PL Zestaw pierścieni segera wewnętrznych
RUS Кольца стопорные внутренние
CZ Sada pojistné kroužky
H Belső seeger-gyűrű készlet

- RO** Set agrafe
F Set de circlips int.
I Set all'interno degli anelli Segera
E Anillos seeger para agujeros interiores
CN 件套内挡圈组套

PLASTIC HANGING BOX

300 PCS

INTERNAL
BEMNETRZNE



Ø 3, 4, 5, 6, 8, 9, 11, 12, 13, 14, 15, 19, 20, 22, 25, 26, 28, 32 mm



YT-06881



5/20

- GB** Feather keys assortment
D Sortiment Federkeile
PL Zestaw klinów półokrągłych
RUS Шпонки полукруглые
CZ Sada klinů polokruhových
H Ives hornyok biztosítására
RO Set pene disc pt. imbinari arbore

- F** Aspérule clés assortiment
I Set di cunei semicircolari
E Surtido de chavetas media luna
CN 键销

PLASTIC HANGING BOX

80 PCS

MIX SIZE
KÖZMÉRŐK



3.0x5.0x13 mm, 3.0x6.5x16 mm, 4.0x5.0x13 mm,
4.0x6.5x16 mm, 4.0x7.5x19 mm, 5.0x7.5x19 mm,
5.0x9.0x22 mm, 6.0x9.0x22 mm



YT-06790



5/25

- GB** Socket head set screw assortment metric
D Sortiment Madenschrauben, metrisch
PL Zestaw śrub imbusowych bez łoża
RUS Набор винтов установочных с плоским концом

- CZ** Šroub stavěcí, plochý konec, bez úpravy
H Set menetes sasszegekkel
RO Set splituri filetate
F Set clavettes de vis
I Set di viti esagonali senza testa
E Conjunto de tornillo chavetas
CN 160件套无头螺钉组套

PLASTIC HANGING BOX

160 PCS

MIX SIZE
KÖZMÉRŐK



HEX INSIDE
HEXAGONAL



3x5 mm, 4x5 mm, 5x6 mm, 6x6 mm, 6x6 mm F, 6x10 mm, 8x10 mm,
8x10 mm F, 8x12 mm, 10x10 mm, 10x10 mm F, 10x12 mm



YT-06777



5/20

- GB** Rubber Grommet Assortment
D Gummi-durchgangs-tullen sortiment
PL Zestaw przelotek gumowych
RUS Набор резиновых втулок

- CZ** Gumové průchodka
H Gumi grommet készlet
RO Presetupa cauciuc pt. cablu
F Coffret passe-cloison caoutchouc

- I** Gommino angello
E Caja surtido de pasamuros de goma
CN 件套垫圈组套



180 PCS

MIX SIZE
KÖZMÉRŐK

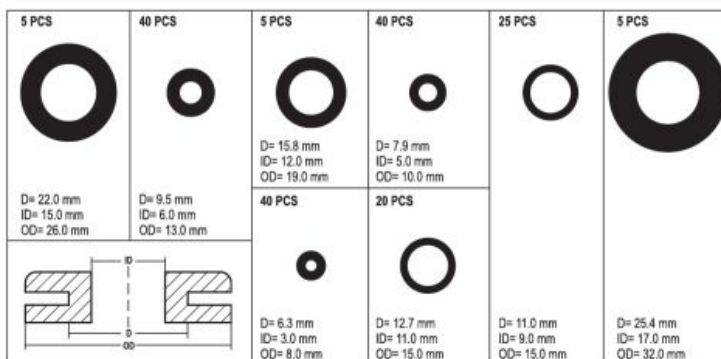

dimensions / wymiary (mm)

YT-06878 6.3; 7.9; 9.5; 11.0; 12.7; 15.8; 22.0; 25.4 5/20

- GB Roll pin assortment
- D Hohlspannstifte
- Spannstifte Sortiment
- PL Zestaw kołków sprężystych
- RUS Набор штифтов разрезных пружинных цилиндрических
- CZ Pružné válcové kolíky se štěrbínou
- H Rugalmas hengeres csapok a nyílásba
- RO Set splinturi elastice
- F Rouleau broche / pin assortment de printemps
- I Perno del rullo assortimento
- E Acero pasador elástico
- CN 315件套热收缩管组套



PLASTIC HANGING BOX

315 PCS **MIX** SIZE ROZMÁŘENÍ



1.5x5mm, 1.5x8mm, 1.5x20mm, 2x6mm, 2x12mm, 2x25mm, 2.5x16mm, 2.5x25mm, 2.5x30mm, 3x16mm, 3x25mm, 3x30mm, 4x16mm, 4x25mm, 4x40mm, 5x16mm, 5x25mm, 5x30mm, 5.5x16mm, 5.5x30mm, 5.5x45mm, 6x16mm, 6x30mm, 6x45mm, 8x20mm, 8x40mm, 8x50mm, 10x20mm, 10x40mm, 10x50mm

YATO YT-06785 5/20

- GB O-ring assortment
- D O-ring Sortiment
- PL Zestaw O-ringów gumowych
- RUS Набор резиновых прокладок

- CZ Gumové „o“ kroužky sada
- H O gyűrű készlet
- RO Garnituri din cauciuc
- F Set d'o-rings en caoutchouc

- I Set guarnizioni O-ring
- E Kit de junta tórica
- CN 件套O型圈组套

PLASTIC HANGING BOX

225 PCS

HEAT RESISTANT TEMPERATURÓDOPORNÓ

OIL, PETROL, CHEMICAL RESISTANT DOPORNÉ NA OLEJ, BENZÝNE, CHEMIKÁLIA



3x1 mm 20 pcs	4x1 mm 20 pcs	4.5x2 mm 20 pcs	5x2 mm 20 pcs	6x2 mm 20 pcs	6x2.5 mm 20 pcs
13x3 mm 5 pcs	14x2.5 mm 5 pcs	17x2.5 mm 5 pcs	18x4 mm 5 pcs	20x2 mm 5 pcs	22x2 mm 5 pcs
6x3 mm 20 pcs	7x2 mm 20 pcs	8x2 mm 20 pcs	9x2 mm 5 pcs	10x2 mm 5 pcs	12x3 mm 5 pcs

YATO YT-06877 5/20

- GB O-Rings assortment for air conditioning
- D O-Ringe für die Klimaanlage
- PL Zestaw O-ringów HNBR do klimatyzacji
- RUS Набор резиновых прокладок для систем кондиционирования воздуха

- CZ Gumový kroužek set klimatizace
- H Gumi gyűrű készlet légkondicionáló
- RO Inele pt. aer conditionat
- F Cercle en caoutchouc boîte de kit combinaison

- I O-Ring assortimento per l'aria condizionata
- E Kit círculo caucho combinación caja
- CN 270PC 绿色O型圈

PLASTIC HANGING BOX

270 PCS

MIX SIZE ROZMÁŘENÍ

HNBR MATERIAL MATERIAL



20x ∅ 5.29 x 1.78 mm	20x ∅ 6.07 x 1.78 mm	20x ∅ 6.8 x 1.9 mm	20x ∅ 7.65 x 1.78 mm	20x ∅ 7.8 x 1.9 mm	20x ∅ 8 x 2 mm
20x ∅ 8.8 x 1.9 mm	15x ∅ 10.82 x 1.78 mm	15x ∅ 10.77 x 2.62 mm	15x ∅ 11 x 2 mm	15x ∅ 12 x 2 mm	10x ∅ 13.9 x 1.8 mm
10x ∅ 13.95 x 2.62 mm	10x ∅ 10 x 2 mm	10x ∅ 15 x 2 mm	10x ∅ 17 x 2 mm	10x ∅ 17.17 x 1.78 mm	10x ∅ 17.04 x 3.53 mm

∅ 5.29 x 1.78 mm, 6.07 x 1.78 mm, 6.8 x 1.9 mm, 7.65 x 1.78 mm, 7.8 x 1.9 mm, 8 x 2 mm, 8.8 x 1.9 mm, 10.82 x 1.78 mm, 10.77 x 2.62 mm, 11 x 2 mm, 12 x 2 mm, 13.9 x 1.8 mm, 13.95 x 2.62 mm, 10 x 2 mm, 15 x 2 mm, 17 x 2 mm, 17.17 x 1.78 mm, 17.04 x 3.53 mm

YATO YT-06879 6/24

- GB O-ring assortment
- D O-ring Sortiment
- PL Zestaw O-ringów gumowych
- RUS Набор резиновых прокладок
- CZ Gumové „o“ kroužky sada
- H O gyűrű készlet
- RO Garnituri din cauciuc
- F Set d'o-rings en caoutchouc
- I Set guarnizioni O-ring
- E Kit de junta tórica
- CN 件套O型圈组套



PLASTIC BOX

419 PCS

MIX SIZE ROZMÁŘENÍ

NBR MATERIAL MATERIAL



3x1.5 mm, 4.4x2 mm, 5x2 mm, 7x1.5 mm, 10x1.5 mm, 10x2.5 mm, 11x2.5 mm, 13x1.5 mm, 13x2.5 mm, 14x2.5 mm, 16x2.5 mm, 18x2.5 mm, 19x2.5 mm, 21x2.5 mm, 22x2.5 mm, 18x3.5 mm, 20x3.5 mm, 22x3.5 mm, 23.5x3.5 mm, 25x3.5 mm, 26.5x3.5 mm, 28x3.5 mm, 30x3.5 mm, 31x3.5 mm, 33x3.5 mm, 34.5x3.5 mm, 36x3.5 mm, 38x3.5 mm, 41x3.5 mm, 44x3.5 mm, 47x3.5 mm, 50x3.5 mm

YATO YT-06876 24

- GB** Electrical clip assortment
D Krokodil-Klemmen-Kortiment
PL Zestaw złącz elektrycznych - krokodylki
RUS Набор разъемов - крокодил
CZ Terminal alligator krokodil přichytek
H Krokodil csipesz keszlet
RO Sortiment cleme crocodil
F Assortiment pinces crocodile
I Set di perni per misure e prove
E Crocodile clip
CN 件套夹头组套



10 pcs / sztuk - Alligator - clip without insulation / Krokodylki nieizolowane
6 pcs / sztuk - Alligator - clip insulation / Krokodylki izolowane
4 pcs / sztuk - Big charging clip insulation / Zaciski duże izolowane
6 pcs / sztuk - Mini alligator - clip / Krokodylki małe izolowane
2 pcs / sztuk - Small charging clip insulation / Zaciski małe izolowane

YATO	dimensions / wymiary (mm)	
YT-06870	50; 55; 60; 65; 70; 80	5/20

- GB** Terminal connectors
D Kabelschuhe schnellkupplung kabelklemme
PL Zestaw szybkozłączy elektrycznych kabelklemme
RUS Набор экспресс-клемм
CZ Kabelova rychlospojka
H Gyors csatlakozó auto
RO Conector rapid pt. auto
F Connecteur rapide
I Connettori terminali
E Conector rapido eléctrico
CN 件套连接片组套

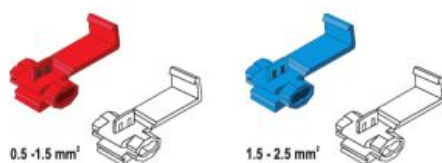

YATO	dimensions / wymiary (mm²)	
YT-06868	0.5 - 1.5; 1.5 - 2.5	5/20

- GB** Heat-shrink tubing set
D Schrumpfschlauch - sortiment
PL Zestaw koszulek termokurczliwych
RUS Набор термоусадочных трубок
CZ Smršťovací bužírka tepelné
H Hőre zsugorodó cső szettek
RO Set tuburi termocontractabile
F Gaine thermoretractable coffret
I Tubo termoretraibile per isolare
E Surtido tubo de conexión eléctrica cable manga
CN 件套热收缩管



Ø 2.0 x 40, 2.5 x 40, 3.5 x 40, 5.0 x 40, 7.0 x 80, 10.0 x 80, 13.0 x 85 mm

YATO		
YT-06866		5/20

- GB** Car fuse assortment
D KFZ-Sicherungs - Set
PL Zestaw bezpieczników

- RUS** Набор предохранителей
CZ Sada pojistek
H Biztosítékkészlet

- RO** Set sigurante
F Ensemble de fusible
I Kit di fusibili lamellari

- E** Conjunto de fusibles
CN 件套车用保险大插件组套



24 PCS

MAXI

(20A, 30A, 40A, 50A, 60A, 70A, 80A, 100A) x3 PCS

YATO		
YT-83140		24



92 PCS

STANDARD

FUSE PULLER CHWYTAK

(5A, 10A, 15A, 20A, 25A, 30A) x15 PCS / VOLTAGE TESTER 6-24V / TESTER

YATO		
YT-83142		24



97 PCS

STANDARD

FUSE PULLER CHWYTAK

(3A, 5A, 7.5A, 10A, 15A, 20A, 25A, 30A) x12 PCS

YATO		
YT-83141		24



121 PCS

MINI

FUSE PULLER CHWYTAK

(5A, 10A, 15A, 20A, 25A, 30A) x20 PCS

YATO		
YT-83143		24

GB Trim clips assortment RUS Набор автомобильного крепежа RO Clip de plastic asortat / Set di clip per auto
 D Befestigungs-Clip-Satz CZ Sada příchytek čalounění F Ensembles de clips en plastique auto E Clip de plástico surtido
 PL Komplet spinek samochodowych H Kötőelemek szegecsek CN 塑料卡扣

PLASTIC HANGING BOX



360 PCS

18 TYPES RODZAJÓW

for / dla: TOYOTA / LEXUS

YATO YT-06650 25



300 PCS

6 TYPES RODZAJÓW

for / dla: RENAULT

YATO YT-06651 25



300 PCS

6 TYPES RODZAJÓW

for / dla: OPEL

YATO YT-06652 25



345 PCS

12 TYPES RODZAJÓW

for / dla: PEUGEOT

YATO YT-06653 25



308 PCS

12 TYPES RODZAJÓW

for / dla: FIAT

YATO YT-06654 25

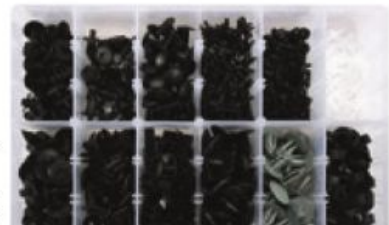

350 PCS

12 TYPES RODZAJÓW

for / dla: VOLVO

YATO YT-06655 25



418 PCS

18 TYPES RODZAJÓW

for / dla: HONDA

YATO YT-06656 25

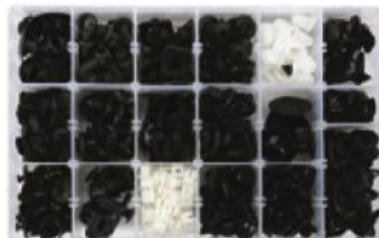

408 PCS

18 TYPES RODZAJÓW

for / dla: NISSAN

YATO YT-06657 25



475 PCS

18 TYPES RODZAJÓW

for / dla: MAZDA

YATO YT-06658 25



370 PCS

12 TYPES RODZAJÓW

for / dla: MITSUBISHI

YATO YT-06659 25



415 PCS

18 TYPES RODZAJÓW

for / dla: FORD

YATO YT-06660 25

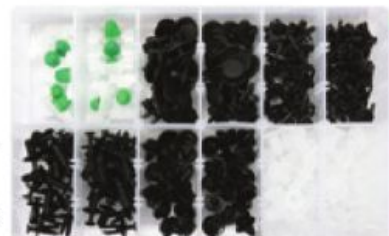

290 PCS

6 TYPES RODZAJÓW

for / dla: BMW

YATO YT-06661 25



270 PCS

12 TYPES RODZAJÓW

for / dla: MERCEDES

YATO YT-06662 25



255 PCS

12 TYPES RODZAJÓW

for / dla: VOLKSWAGEN

YATO YT-06663 25



160 PCS

12 TYPES RODZAJÓW

for / dla: AUDI

YATO YT-06664 25

Memo

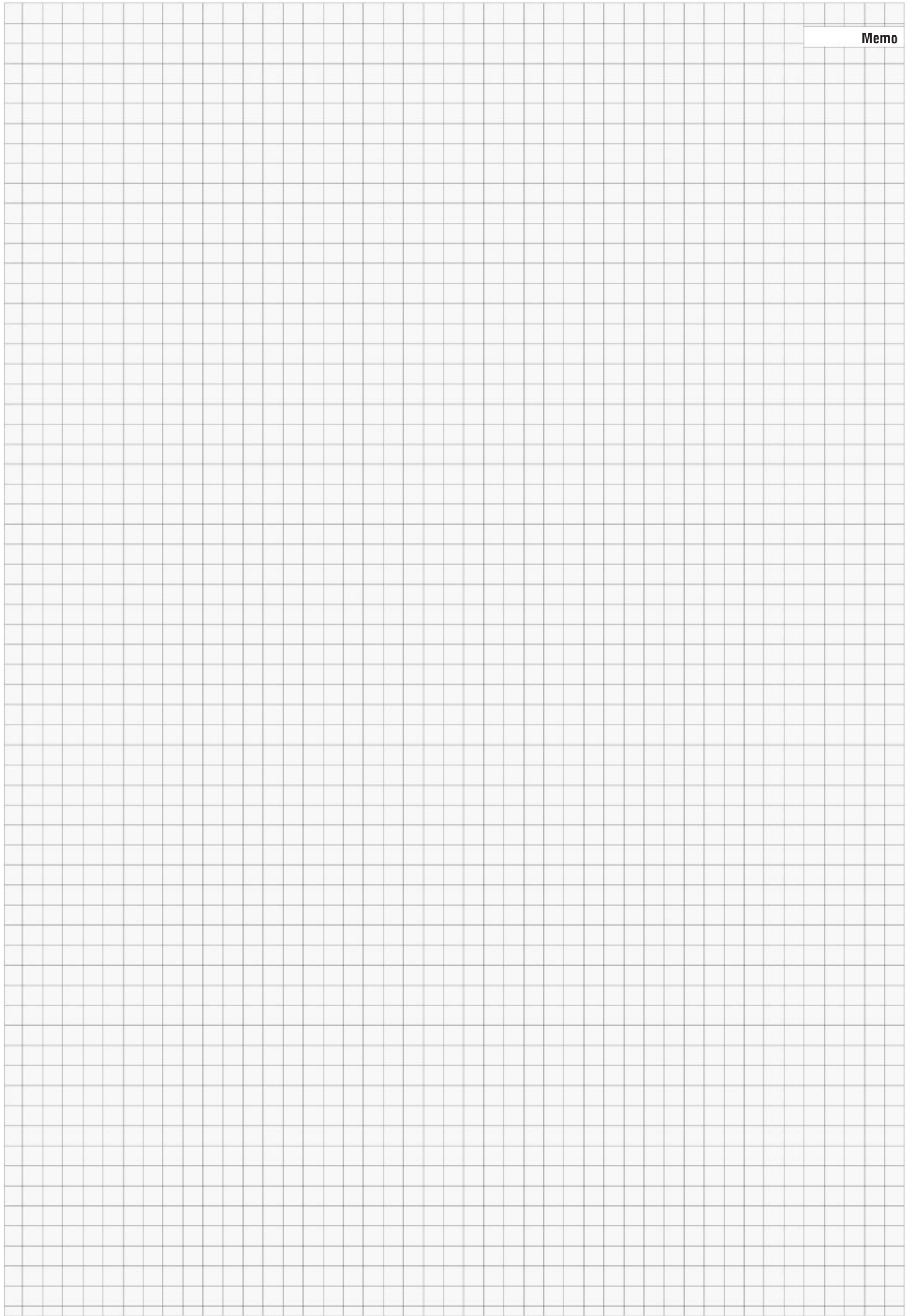

17

Welding equipment & accessories Narzędzia spawalnicze i akcesoria



Plasma cutters & accessories
Przecinarki plazmowe i akcesoria

392



Profile connection & forming pliers
Szcypce do łączenia i kształtowania profili

395



Welding helmets & accessories
Przyłbice spawalnicze i akcesoria

392



Spot weld cutter sets
Zestawy rozwiertaków do zgrzewów

395



Ball pein hammers & sets
Młotki blacharskie i zestawy

393



Combination edge setters & hole punch pliers
Dziurkarko-felcarki

396



Dead blow hammers
Młotki bezodrzutowe

393



Magnetic holders
Wsporniki magnetyczne

396



Lock grip pliers
Szcypce zaciskowe

394



Tin snips
Nożyce do blachy

397-401



Self-locking multi grip pliers	
Szcypce blacharskie.....	394
Welding locking pliers	
Szcypce zaciskowe, spawalnicze.....	394
Flat locking pliers	
Szcypce zaciskowe o szerokich szczękach.....	394
C-type welding locking pliers	
Szcypce zaciskowe, klamrowe typu „C”.....	394
Chain locking pliers	
Szcypce zaciskowe z łańcuchem.....	394

- GB Plasma cutter
- D Inverterplasma-schneider
- PL Przecinarka plazmowa
- RUS Плазматрон
- CZ Plazmová řezačka
- H Plazmavágó
- RO Aparat tăiere cu plasma
- F Coupeuse plasma
- I Taglio al plasma
- E Cortador de plasma
- CN 等离子切割机



40 A	230V~50Hz	DUTY CYCLE CYKL PRACY 60%	IGBT	12 mm STEEL STAL CUTTING THICKNESS GRUBOŚĆ CIĘCIA
HF ARC START INICJACJA ŁUKU	0.4-0.45 MPa	A WINDING INSULATION CLASS KLASA IZOLACJI WINDUJĄCYCH	IP21S	10 mm ALUMINIUM ALUMINIUM CUTTING THICKNESS GRUBOŚĆ CIĘCIA
OVERHEAT PROTECTION OCHRONA PRZED PRZEGRZANIEM	OVERCURRENT PROTECTION ZABEZPIECZENIE PRĄDOWE	7 mm COPPER MIEDŹ CUTTING THICKNESS GRUBOŚĆ CIĘCIA		



COLOR BOX

YATO	A	
YT-82952	40	1

- GB Plasma cutter accessories
- D Inverterplasma-schneider-Zusätze
- PL Akcesoria do przecinarki plazmowej
- RUS Расходные детали для плазматронов
- CZ Příslušenství k plazmové řezačce
- H Plazmavágó alkatrészek
- RO Aparat tăiere cu plasma accesorii
- F Coupeuse plasma accessoires
- I Accessori compatibili
- E Plasma cutter corte consumibles electrodos consejos
- CN 切割头套装



POLYBAG WITH HEADER



4 PCS

for / dla: YT-82952

YATO		
YT-82953		100

- GB Auto-darkening welding helmet
- D Schweißmaske, selbstverdunkelnd
- PL Przyłbica spawalnicza samościemniająca
- RUS Маска для сварки, самостоятельно затемняющаяся
- CZ Svářečská kukla samostmívací
- H Önmagától sötétedő hegesztőpajzs
- RO Mască de sudură auto-întunecare
- F Masque de soudage
- I Oscuramento casco di saldatura
- E Casco auto-oscurecedor para soldadura
- CN 工具车双挂板



DARK STATE STAN CIEMNY 9-13	LIGHT STATE STAN JASNY 4	REACTION TIME CZAS REAKCJI 1/25000 s	BRIGHTENING TIME CZAS ROZJAŚNIANIA 0.1-1.0 s	FILTER TEST TEST FILTRA	LOW BATTERY ALARM WSKAZNIK POZIOMU BATERII	CR2045 BATTERIES NOT INCLUDED WYKŁADZIKI NIE WŁĄCZONO	WORKING TEMPERATURE TEMPERATURA PRACY -5°C/+55°C
------------------------------------	---------------------------------	---	---	--------------------------------	---	--	---

4 POINT HEADGEAR WIĘZBA 4 PUNKTOWA

Lock into a detent when lifted
Blokada w pozycji podniesionej

2-point crown strap adjustment to rise or lower the helmet
2 punktowa regulacja wysokości

3 position slider to adjust the distance from eyes to lens
3 pozycje regulacji odległości od filtra

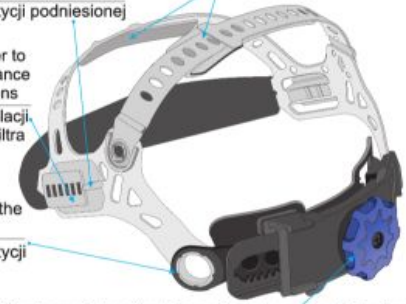

Regulation at the occipital area
Regulacja pozycji potylicznej

Ratchet with soft rubber grip to adjust size without removing the helmet
Regulacji obwodu za pomocą systemu grzechotkowego

- EN 379
- optical class: 1 / 1 / 1 / 1
- cover lens YT-73924 included
- klasa optyczna: 1 / 1 / 1 / 1
- w zestawie szybki ochronne YT-73924

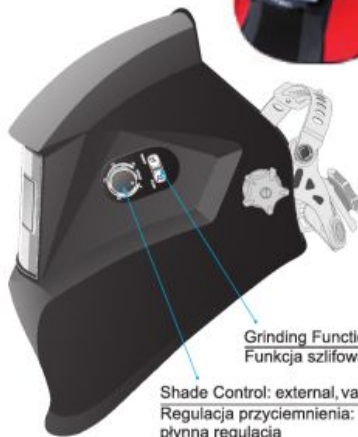

Grinding Function: YES
Funkcja szlifowania: TAK

Shade Control: external, variable
Regulacja przyciemnienia: zewnętrzna, płynna regulacja

Solar cell filter power supply during welding
Ogniwo słoneczne zasilanie filtru podczas spawania

Arc Sensor: 4
Liczba czujników łuku: 4

Viewing Area: 98x43 mm
Obszar pola widzenia: 98x43 mm

UV/IR Protection
Ochrona przed promieniowaniem UV/IR

Automatic power on / off
Automatyczne włączenie / wyłączenie

Sensitivity Control
Regulacja czułości

The rate of dimming
Szybkość ściemniania 0.3 - 1.0 ms



COLOR BOX

YATO		
YT-73921		6

- GB Front cover lens
- D Außerschutzglas
- PL Szybka ochronna do przyłbicy samościemniającej
- RUS Стекло защитное наружное
- CZ Přední krycí skříčko
- H Kűlső védőlemez
- RO Protecția exterioră de plastic
- F Verres de protection
- I Martello per lamiera
- E Cubierta de la lente de soldadura
- CN 前盖镜片



5 PCS	123x98 mm	PC
--------------	------------------	-----------

for / dla: YT-73921

POLYBAG

YATO		
YT-73924		20/160

TYPE FC-11 EN 166:2001 B

- GB Auto body fender set
D Karosserie-Ausbeulsatz
PL Komplet młotków blacharskich
RUS Молотки рихтовочные
CZ Souprava klempířských kladívek
H Bádogos kalapács készlet
RO Set de ciocane de tablă
F Set pour carrossier
I Martello per lamiera
E Juego de mazos de hojalatero
CN 钣金工具组套



7
PCS

DROP
FORGED
KUTE

GENUINE
HICKORY

BMC
& COLTOP
SLEEVE



YATO	m (g)	
YT-4590	4900	4

- GB Ball pein hammer
D Ausbeulhammer
PL Młotek blacharski
RUS Молоток рихтовочный
CZ Klempířské kladívko
H Bádogos kalapács
RO Ciocan pt. tablă
F Marteau à panne ronde
I Martello per lamiera
E Martillo de hojalatero
CN 圆头锤



FIBREGLASS
WŁÓKNO
SZKLANE

YATO	m (g)	L (mm)	A (mm)	H (mm)	
YT-4515	225	280	26	80	6/36
YT-4516	450	315	34	100	6/24
YT-4518	900	380	40	125	6/12

- GB Ball pein hammer
D Ausbeulhammer
PL Młotek blacharski
RUS Молоток рихтовочный
CZ Klempířské kladívko
H Bádogos kalapács
RO Ciocan pt. tablă
F Marteau à panne ronde
I Martello per lamiera
E Martillo de hojalatero
CN 圆头锤



YATO	m (g)	L (mm)	A (mm)	H (mm)	
YT-4519	225	295	26	80	6/36
YT-4520	450	335	35	100	6/24
YT-4521	680	360	36	115	6/12
YT-4522	900	380	40	125	6/12

- GB Dead blow mallet
D Rückschlagsfreier
Schonhammer
PL Młotek bezodrztowy
RUS Молоток безинерционный
CZ Palička nárazová plněná
celogumová
H Visszarúgás mentes
gumikalapács
RO Ciocan cu absorbție
F Maillet sans recul
I Martello morto colpo
E Martillo sin reacción
CN 防震无回弹橡胶锤



PU

YATO	m (g)	L (mm)	Ø (mm)	H (mm)	
YT-4624	265	318	30.0	94	10/40
YT-4625	430	350	40.0	100	6/36
YT-4626	490	348	45.0	110	6/36

- GB Dead blow mallet
D Rückschlagsfreier
Schonhammer
PL Młotek bezodrztowy
RUS Молоток безинерционный
CZ Palička nárazová
plněná celogumová
H Visszarúgás mentes
gumikalapács
RO Ciocan cu absorbție
F Maillet sans recul
I Martello morto colpo
E Martillo sin reacción
CN 防震无回弹橡胶锤



PU



YATO	m (g)	L (mm)	Ø (mm)	H (mm)	
YT-4620	740	300	44.5	100.0	4/24
YT-4622	900	336	53.5	100.0	4/24
YT-4623	1300	350	59.0	118.5	3/12

- GB PU & nylon heads mallet
D Schonhammer
mit PU & Nylon-Schlagkopf
PL Młotek blacharski
RUS Молоток рихтовочный
CZ Palička klempířská
H Vaskalapács
RO Ciocan tinichigerie
cap PU / nylon
F Marteau spécial
en PU / nylon
I Martello per lamiera
E Martillo chapista
CN 木柄安装锤



PU NYLON

YATO	m (g)	L (mm)	Ø (mm)	H (mm)	
YT-4630	150	250	22	75	6/48
YT-4631	250	280	28	85	6/36
YT-4632	340	315	35	95	6/36
YT-4633	660	350	45	105	6/24
YT-4634	1340	380	60	132	4/16

GB Self-locking multi grip pliers
 D Grip-Festhaltezeuge
 PL Szczypce blacharskie
 RUS Зажим ручной сварочный для закрепления лент и профилей
 CZ Kleště klempířské samodržící
 H Őnzáró rőgzítőfogó

RO Clește autoblocant pt. tinichigerie
 F Pince pour tôle
 I Pinze per lamiera
 E Pinzas de chapa
 CN 多功能大力钳



SLIDING CARD
CrMo



200 mm 0-15 mm 70 mm TYPE W

YATO	L (mm)	
YT-2160	200	12/24



230 mm 0-15 mm 45 mm TYPE JJ

YATO	L (mm)	
YT-2161	230	12/24



215 mm 0-10 mm 45 mm TYPE LL

YATO	L (mm)	
YT-2162	215	12/36

GB Welding locking pliers
 D Klemmzange zum Schweißen
 PL Szczypce zaciskowe spawalnicze
 RUS Клещи давяльные сварочные
 CZ Kleště samosvorné svářečské
 H Hegesztő fogó
 RO Clește de strângere pt. sudură

F Pincés de serrage pour soudeur
 I Pinze di bloccaggio per saldatura
 E Pinzas de tornillo (de apriete) para soldar
 CN 焊接用大力钳



HALF DOUBLE BLISTER
225 mm

TYPE U

0-85 mm

70 mm



YATO	L (mm)	
YT-2461	225	6/24

GB Flat locking pliers
 D Klemmzange mit breiten Backen
 PL Szczypce zaciskowe o szerokich szczękach
 RUS Клещи давяльные с широкими губками
 CZ Kleště samosvorné se širokými čelistmi
 H Lapos fogó

RO Clește de strângere plat / patent
 F Pince de serrage large
 I Pinze con ganasce piane e palette
 E Pinzas de tornillo (de apriete) con mordazas anchas
 CN 铁皮大力钳



HALF DOUBLE BLISTER
200 mm

0-50 mm

75 mm



YATO	L (mm)	
YT-2463	200	6/24

GB Sliding arm welding locking pliers
 D Parallel-gripzange
 PL Szybkonastawne szczypce spawalnicze
 RUS Образная струбцина с захватом
 CZ Paralelné samosvorné kleště
 H Szorítórúdas őnzáró fogó
 RO Clește de mana cu prindere

tip menghina
 F Pince-étai - serre-joint coulissant
 I Scorrevole pinze di bloccaggio di saldatura braccio
 E Pinzas de presion tipo sargento
 CN C型滑杆大力钳

260 mm 0-150 mm

QUICK-ADJUSTMENT SZYBKONASTAWNY

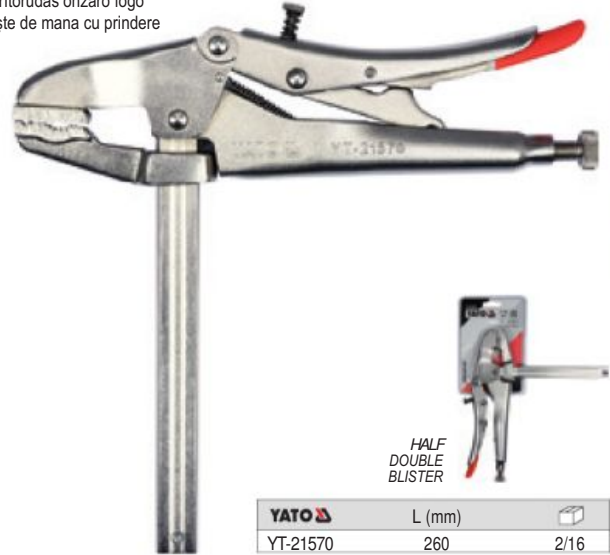

YATO	L (mm)	
YT-21570	260	2/16

GB C-type welding locking pliers
 D Klemm- und Klammerzange vom Typ „C“
 PL Szczypce zaciskowe klamrowe typu „C“
 RUS Клещи давяльные типа „C“
 CZ Kleště samosvorné upínací typu „C“

H „C“ fogó
 RO Clește de strângere cu demă tip „C“
 F Pince de serrage type „C“
 I Pinze di bloccaggio tipo „C“
 E Pinzas de tornillo (de apriete) de grapa tipo „C“
 CN C型大力钳



HALF DOUBLE BLISTER
280 mm

TYPE C

0-100 mm



MOVABLE JAWS RUCHOME SZCZĘKI



YATO	L (mm)	
YT-2466	280	6/24

0-80 mm



YATO	L (mm)	
YT-2468	280	6/24

GB Chain locking pliers
 D Klemmzange mit Kette
 PL Szczypce zaciskowe z łańcuchem
 RUS Клещи давяльные с цепью
 CZ Kleště samosvorné s řetězem
 H Láncos csőfogó
 RO Clește de strângere cu lanț
 F Pince de serrage avec une chaîne

I Pinze di bloccaggio con la catena
 E Pinzas de tornillo (de apriete) con cadena
 CN 链条大力钳



HALF DOUBLE BLISTER
500 mm

40 mm



YATO	L (mm)	
YT-2469	500	6/24

GB Profile connection pliers
D Zange zum Verbinden der Profile
PL Szczypce do łączenia profili
RUS Щипцы для соединения профилей
CZ Kleště ke spojování profilů

H Profilyegység fogó
RO Cleste pt. îmbinarea profilelor
F Pince pour sertir les profiles
I Pinze per la unione profili
E Pinzas para conectar perfiles
CN 龙骨钳

SLIDING CARD
SECTION THICKNESS
GRUBOSC PROFILU
0.5-0.8 mm



275 mm
A380 AI-TI ALLOY (HEAD)
GR15 BEARING STEEL (PUNCH)

YATO	L (mm)	
YT-5130	275	6/24

GB Profile connection pliers
D Zange zum Verbinden der Profile
PL Szczypce do łączenia profili
RUS Щипцы для соединения профилей
CZ Kleště ke spojování profilů
H Profilyegység fogó
RO Cleste pt. îmbinarea profilelor

F Pince pour sertir les profiles
I Pinze per la unione profili
E Pinzas para conectar perfiles
CN 新款长柄龙骨钳

280 mm
SECTION THICKNESS
GRUBOSC PROFILU
0.5-0.8 mm

GR15 BEARING STEEL (PUNCH)

A380 AI-TI ALLOY (HEAD)

SLIDING CARD



YATO	L (mm)	
YT-5131	280	6/24



345 mm
65 Mn MATERIAL OF PUNCH
PUNKTAK

YATO	L (mm)	
YT-5131	345	6/24

GB Punch pliers
D Blech Lochzange
PL Szczypce do dziurkowania blach
RUS Просекатель круглых отверстий
CZ Děrovací kleště
H Fogó peremező lyukasztó

RO Cleste pt. perforat
F Trou pince feuilles
I Pinza per forare lamiera
E Punzonadora una mano perfiles
CN CS打孔钳

240 mm
PUNCH DIAMETER
SREDNICA OTWORU
Ø 3.2 mm

GR15 BEARING STEEL (PUNCH)

SLIDING CARD



YATO	L (mm)	
YT-5132	240	5/30

GB Profile forming pliers
D Zange zur Formgebung der Profile
PL Szczypce do kształtowania profili
RUS Щипцы для формироваки профилей
CZ Kleště k tvarování profilů

H Profilformázó fogó
RO Cleste pt. modelarea profilelor
F Pince pour former les profiles
I Pinze per la formazione di profili
E Pinzas para formar perfiles
CN 龙骨钳

SLIDING CARD
210 mm



80x35 mm
JAWS
SZCZEPKI

YATO	L (mm)	
YT-5140	210	2/12



80x35 mm
JAWS
SZCZEPKI

YATO	L (mm)	
YT-5141	210	2/12



150x35 mm
JAWS
SZCZEPKI

YATO	L (mm)	
YT-5142	210	2/12

GB Spot weld cutter & drill bit set
D Schweisspunktbohrer Set
Schweisspunktfräser
PL Zestaw rozwiertaków do zgrzewów punktowych
RUS Набор для высверливания точечной сварки
CZ Sada na odvrtání bodových svárů
H Hegesztőpont maró készlet
RO Set de freze pt. suduri în puncte
F Jeu de fraises pour points de soudage
I Set di alesatori per punti di saldatura
E Juego de puntos de soldadura de la fresa
CN 点焊刀



9 PCS
Ø 8 mm

Ø 10 mm
HSS

METAL BOX & COLOR BOX



YATO		
YT-28920		10/60

GB Drill welding points set
D Schweisspunkt-Fräsersatz
PL Zestaw wiertel do zgrzewów punktowych
RUS Набор сверл для точечной сварки
CZ Frézy pro bodové sváry
H Pont hegesztés lefűró készlet
RO Set burghiu puncte sudura
F Forets à dépointer les points soudure
I Set di alesatori per punti di saldatura
E Juego de brocas para puntos de soldadura
CN 3件套电焊



3 PCS

COBALT COATED
POKRYTE KOBALTEM

METAL BOX & COLOR BOX

YATO	Ø (mm)	
YT-28921	6.5; 8.0; 10.0	50

GB Combination edge setter / hole punch pliers
 D Kombinierte Absetzange Lochzange
 PL Dziurkarko-felcarka
 RUS Дырокол, кромкогиб
 CZ Falcovačka a děrovačka
 H Lyukasztó peremező fogó
 RO Cleste pt. fasonat si gaurit tabla

F Pince spéciale perforatrice carrosserie
 I Combinazione: bordo setter / pinza perforare
 E Solapadora y ponchadora manual
 CN 点焊刀

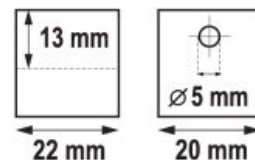

HANGING COLOR BOX

YATO	
YT-21582	10

GB Adjustable angle welding magnet
 D Verstellbarer Magnet-Werkstückhalter
 PL Wspornik magnetyczny spawalniczy regulowany
 RUS Регулируемый магнит заварки угла
 CZ Polohovací magnetický držák ke svařování
 H Állítható, mágneses, hegesztő támasz
 RO Dispozitiv magnetic regulabil pt. sudura
 F Support magnétique de soudure
 I Supporto della saldatura magnetico
 E Soporte magnético de soldadura, ajustable
 CN 焊接磁铁



DOUBLE BLISTER

YATO	⌋ (kg)	mm	
YT-0862	2x22.5	85x65x22	6

GB Magnetic welding holder
 D Magnet-Werkstückhalter
 PL Kałownik magnetyczny spawalniczy
 RUS Магнитная струбцина заварки

CZ Magnetický uhelník ke svařování
 H Mágneses, hegesztő szögvas
 RO Dispozitiv magnetic fixare pt. sudura
 F Support magnétique de soudure

I Angolo magnetico da saldatura
 E Escuadra magnética de soldadura
 CN 焊接磁铁

DOUBLE BLISTER

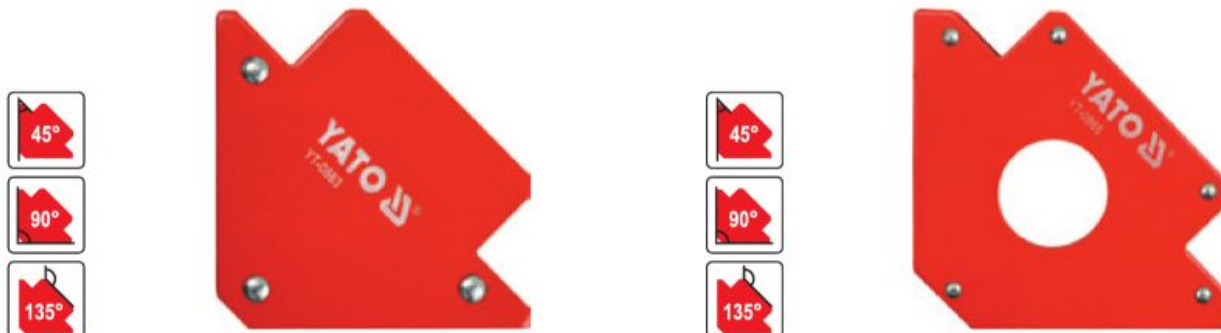

YATO	⌋ (kg)	mm	
YT-0863	11.5	82x120x13	6/48

YATO	⌋ (kg)	∅ (mm)	mm	
YT-0864	22.5	18	102x155x17	6/30
YT-0865	34.0	46	122x190x25	6/18

GB Magnetic welding holder
 D Magnet-Werkstückhalter
 PL Kałownik magnetyczny spawalniczy
 RUS Магнитная струбцина заварки
 CZ Magnetický uhelník ke svařování
 H Mágneses, hegesztő szögvas

RO Dispozitiv magnetic fixare pt. sudura
 F Support magnétique de soudure
 I Triangolo magnetico da saldatura con interruttore
 E Escuadra magnética de soldadura con interruptor
 CN 焊接磁铁

GB Magnetic welding holder with switch
 D Magnet-Werkstückhalter mit Schalter
 PL Kałownik magnetyczny spawalniczy z wyłącznikiem
 RUS Магнитный держатель заварки с выключателем
 CZ Magnetický uhelník ke svařování s vypínačem
 H Mágneses, hegesztő szögvas, kapcsolóval

RO Dispozitiv magnetic fixare pt. sudura cu intrerupator
 F Support magnétique de soudure avec interrupteur
 I Triangolo magnetico da saldatura con interruttore
 E Escuadra magnética de soldadura, con interruptor
 CN 焊接磁铁



DOUBLE BLISTER

YATO	⌋ (kg)	mm	
YT-0866	11.5	64x95x14	6/24
YT-0867	34.0	111x136x24	6/18



DOUBLE BLISTER

YATO	⌋ (kg)	mm	
YT-0870	13.5	107x160x26	6/24

GB Tin snips
D Blechscherer
PL Nożyce do cięcia blachy

RUS Ножницы по металлу
CZ Nůžky na plech
H Lemezvágó olló

RO Foarfece pt. tablă
F Cisaille à tôle
I Cesioie per lamiere

E Tijeras para chapas
CN 铁皮剪

SLIDING
CARD



HRC 60-62

DIN 6438



HRC 60-62

DIN 6438



YATO	L (mm)	cutting length (mm)	cutting capacities (mm)				6/36
			copper	cold-rolled steel	hard steel HRC35	stainless steel 304	
YT-1910	260	35	1.80	1.50	1.00	0.90	6/36

YATO	L (mm)	cutting length (mm)	cutting capacities (mm)				6/36
			copper	cold-rolled steel	hard steel HRC35	stainless steel 304	
YT-1915	235	30	1.50	1.20	1.00	0.70	6/36

HRC 60-62

DIN 6438



HRC 56-62

SHARPENED EDGES ZARÓWNIANA KRAWĘDZ OSTRZY

HIGH FREQUENCY HARDENING HARTOWANIE IMPULSOWE



YATO	L (mm)	cutting length (mm)	cutting capacities (mm)				6/36
			copper	cold-rolled steel	hard steel HRC35	stainless steel 304	
YT-1918	260	32	1.80	1.50	1.00	0.90	6/36

YATO	L (mm)	cutting length (mm)	cutting capacities (mm)				6/36
			copper	cold-rolled steel	hard steel HRC35	stainless steel 304	
YT-1960	250	40	2.00	1.50	1.00	0.80	6/36

GB Tin snips
D Blechscherer
PL Nożyce do cięcia blachy
RUS Ножницы по металлу
CZ Nůžky na plech
H Lemezvágó olló
RO Foarfece pt. tablă
F Cisaille à tôle
I Cesioie per lamiere
E Tijeras para chapas
CN 铁皮剪



SLIDING
CARD



YATO	L (mm)	cutting length (mm)	cutting capacities (mm)				6/36
			copper	cold-rolled steel	hard steel HRC35	stainless steel 304	
YT-1913	225	30	0.78	0.53	0.46	0.36	6/36

GB Tin snips
D Blechscherer
PL Nożyce do cięcia blachy

RUS Ножницы по металлу
CZ Nůžky na plech
H Lemezvágó olló

RO Foarfece pt. tablă
F Cisaille à tôle
I Cesioie per lamiere

E Tijeras para chapas
CN 铁皮剪

SLIDING
CARD



HRC 60-62

DIN 6438



HRC 60-62

DIN 6438



YATO	L (mm)	cutting length (mm)	cutting capacities (mm)				6/36
			copper	cold-rolled steel	hard steel HRC35	stainless steel 304	
YT-1912	260	35	1.80	1.50	1.00	0.90	6/36

YATO	L (mm)	cutting length (mm)	cutting capacities (mm)				6/36
			copper	cold-rolled steel	hard steel HRC35	stainless steel 304	
YT-1922	290	75	1.10	0.94	0.70	0.53	6/36

HRC 60-62

DIN 6438



HRC 56-62

SHARPENED EDGES ZARÓWNIANA KRAWĘDZ OSTRZY

HIGH FREQUENCY HARDENING HARTOWANIE IMPULSOWE



YATO	L (mm)	cutting length (mm)	cutting capacities (mm)				6/36
			copper	cold-rolled steel	hard steel HRC35	stainless steel 304	
YT-1923	230	25	2.00	1.60	1.20	1.20	6/36

YATO	L (mm)	cutting length (mm)	cutting capacities (mm)				6/36
			copper	cold-rolled steel	hard steel HRC35	stainless steel 304	
YT-1962	250	45	2.00	1.50	1.00	0.80	6/36

GB Tin snips
D Blechscherer
PL Nożyce do cięcia blachy

RUS Ножницы по металлу
CZ Nůžky na plech
H Lemezvágó olló

RO Foarfece pt. tablă
F Cisaille à tôle
I Cesioie per lamiera

E Tijeras para chapas
CN 铁皮剪

SLIDING
CARD



RIGHT CUT
CIECIE
PRAWO

CrMo

INCREASED CUTTING POWER
DIMENSIONAL STABILITY

HRC 60-62

DIN 6438



HRC 60-62

DIN 6438



YATO	L (mm)	cutting length (mm)	cutting capacities (mm)				6/36
			copper	cold-rolled steel	hard steel HRC35	stainless steel 304	
YT-1911	260	35	1.80	1.50	1.00	0.90	6/36

YATO	L (mm)	cutting length (mm)	cutting capacities (mm)				6/36
			copper	cold-rolled steel	hard steel HRC35	stainless steel 304	
YT-1916	235	30	1.50	1.20	1.00	0.70	6/36

HRC 60-62

DIN 6438



HRC 56-62

SERRATED EDGES
ZARZKOWANA
PRAWICZ
OSTRZY

HIGH FREQUENCY
HARDENING
HARTOWANIE
MIPUSZCIE



YATO	L (mm)	cutting length (mm)	cutting capacities (mm)				6/36
			copper	cold-rolled steel	hard steel HRC35	stainless steel 304	
YT-1919	260	32	1.80	1.50	1.00	0.90	6/36

YATO	L (mm)	cutting length (mm)	cutting capacities (mm)				6/36
			copper	cold-rolled steel	hard steel HRC35	stainless steel 304	
YT-1961	250	40	2.00	1.50	1.00	0.80	6/36

GB Tin snips
D Blechscherer
PL Nożyce do cięcia blachy
RUS Ножницы по металлу
CZ Nůžky na plech
H Lemezvágó olló
RO Foarfece pt. tablă
F Cisaille à tôle
I Cesioie per lamiera
E Tijeras para chapas
CN 铁皮剪



RIGHT CUT
CIECIE
PRAWO

HRC 60-62

90°

SERRATED EDGES
ZARZKOWANA
PRAWICZ
OSTRZY

SLIDING
CARD



YATO	L (mm)	cutting length (mm)	cutting capacities (mm)				6/36
			copper	cold-rolled steel	hard steel HRC35	stainless steel 304	
YT-1914	225	30	0.78	0.53	0.46	0.36	6/36

GB Tin snips
D Blechscherer
PL Nożyce do cięcia blachy
RUS Ножницы по металлу
CZ Nůžky na plech
H Lemezvágó olló
RO Foarfece pt. tablă
F Cisaille à tôle
I Cesioie per lamiera
E Tijeras para chapas
CN 铁皮剪



SLIDING
CARD



LEFT CUT
CIECIE
LEWE

DROP FORGED
KUTE

HRC 58-61

YATO	L (mm)	cutting length (mm)	cutting capacities (mm)				6/24
			copper	cold-rolled steel	hard steel HRC35	stainless steel 304	
YT-1900	260	30	0.94	0.78	0.60	0.45	6/24

GB Tin snips
D Blechscherer
PL Nożyce do cięcia blachy
RUS Ножницы по металлу
CZ Nůžky na plech
H Lemezvágó olló

RO Foarfece pt. tablă
F Cisaille à tôle
I Cesioie per lamiera
E Tijeras para chapas
CN 铁皮剪

SLIDING
CARD



RIGHT CUT
CIECIE
PRAWO

DROP FORGED
KUTE

HRC 58-61



YATO	L (mm)	cutting length (mm)	cutting capacities (mm)				6/24
			copper	cold-rolled steel	hard steel HRC35	stainless steel 304	
YT-1901	260	30	0.94	0.78	0.60	0.45	6/24

YATO	L (mm)	cutting length (mm)	cutting capacities (mm)				6/24
			copper	cold-rolled steel	hard steel HRC35	stainless steel 304	
YT-1902	300	50	0.94	0.78	0.60	0.45	6/24

- GB Tin snips
D Blechscherer
PL Nożyce do cięcia blachy
RUS Ножницы по металлу
CZ Nůžky na plech
H Lemezvágó olló
- RO Foarfece pt. tablă
F Cisaille à tôle
I Cesioie per lamiera
E Tijeras para chapas
CN 铁皮剪



For cutting straight and tight curves left or right



STRAIGHT CUT
CIECIE PROSTE

HRC 58-61

DROP FORGED
KUTE

YATO	L (mm)	cutting length (mm)	cutting capacities (mm)				6/36
			copper	cold-rolled steel	hard steel HRC35	stainless steel 304	
YT-1925	225	52	0.94	0.78	0.60	0.45	6/36



HRC 58-60

YATO	L (mm)	cutting length (mm)	cutting capacities (mm)				6/36
			copper	cold-rolled steel	hard steel HRC35	stainless steel 304	
YT-1920	260	42	1.20	1.00	0.60	0.50	6/36

- GB Tin snips
D Blechscherer
PL Nożyce do cięcia blachy
RUS Ножницы по металлу
CZ Nůžky na plech
H Lemezvágó olló
- RO Foarfece pt. tablă
F Cisaille à tôle
I Cesioia roditrice per lamiera
E Tijeras para chapas
CN 铁皮剪



For cutting straight and tight curves left or right



HRC 58-61

YATO	L (mm)	cutting length (mm)	cutting capacities (mm)				6/36
			copper	cold-rolled steel	hard steel HRC35	stainless steel 304	
YT-1924	254	52	0.94	0.78	0.60	0.45	6/36

- GB Metal sheet nibbler
D Blechnibbler
PL Nożyce matrycowe do blachy
RUS Ножницы для резки жести
CZ Nůžky na plech
H Lemezvágó olló
- RO Foarfece pt. tablă
F Grignoteuse a tole
I Cesioia roditrice per lamiera
E Tijeras para chapas
CN 法式剪

260 mm

1 mm METAL PLATE BLACHA

1.2 mm ALUMINIUM COOPER ALLUMINIUW MIEZEL

2 mm PLASTIC PLASTIK

Mn 65

3 mm CHANGEABLE CUTTING BLADES WYMIENNE OSTRZA



HALF DOUBLE BLISTER



YATO	L (mm)	6/36
YT-19260	260	6/36

- GB Tin snips
D Blechscherer
PL Nożyce do cięcia blachy
RUS Ножницы по металлу
CZ Nůžky na plech
H Lemezvágó olló
RO Foarfece pt. tablă
F Cisaille à tôle
I Cesioie per lamiera
E Tijeras para chapas
CN 铁皮剪



YATO	L (mm)	cutting length (mm)	cutting capacities (mm)				6/36
			copper	cold-rolled steel	hard steel HRC35	stainless steel 304	
YT-1963	200	40	1.5	1.0	0.6	0.6	6/36
YT-1964	250	60	1.8	1.2	0.8	0.8	6/24
YT-1965	300	75	2.0	1.4	0.8	0.8	6/12

- GB Tin snips
D Blechscherer
PL Nożyce do cięcia blachy
RUS Ножницы по металлу
CZ Nůžky na plech
H Lemezvágó olló
RO Foarfece pt. tablă
F Cisaille à tôle
I Cesioie per lamiera
E Tijeras para chapas
CN 铁皮剪



YATO	L (mm)	cutting length (mm)	cutting capacities (mm)				6/36
			copper	cold-rolled steel	hard steel HRC35	stainless steel 304	
YT-1970	260	42	2.0	1.4	1.0	1.0	6/36

- GB Spare blades for metal sheet nibbler
D Abbrechklängen für Blechnibbler
PL Ostrza zapasowe do nożyc matrycowych
RUS Лезвия для ножиц для резки жести
CZ Ostrů nahradní
H Tartalékpenge
- RO Lame de rezervă
F Lame sécables pour grignoteuse a tole
I Lame di ricambio per cesioia roditrice per lamiera
E Cuchillas de cambio
CN 法式剪备用刀片

3 PCS

Mn 65



for / dla: YT-19260

YATO	10/100
YT-19261	10/100

GB Steel strap cutter
 D Stahlgurtblechscherer
 PL Nożyce do cięcia taśmy stalowej
 RUS Ножницы для резки стальной ленты
 CZ Nůžky na plech
 H Lemezvágó olló
 RO Foarfece pt. tablă

F Cisailla à bande acier
 I Cesoia per taglio reggetta in acciaio
 E Tijeras para bandejas de acero
 CN 钢带剪

HRC
58-61

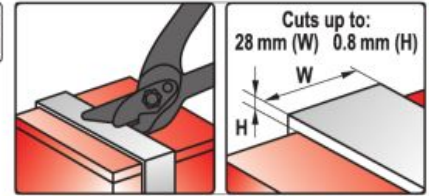

SLIDING
CARD

YATO	L (mm)	cutting length (mm)	cutting capacities (mm)				6/24
			copper	cold-rolled steel	hard steel HRC35	stainless steel 304	
YT-1930	305	28	-	1.00	0.80	0.60	

GB Portable notchers
 D Schere zum Ausschneiden von Ecken
 PL Nożyce do wycinania naroży
 RUS Ножницы для наружных углов
 CZ Nůžky na vystřihování rohů
 H Sarokkivágó olló
 RO Foarfece pt. taierea colturilor
 F Ciseaux pour le coupage des coins
 I Cesoia per taglio reggetta in angoli
 E Tijera para esquinas
 CN 截角器

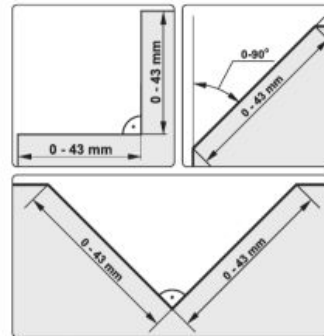

300 mm 90°

YATO	L (mm)	15
YT-1939	300	

GB Hand notchers
 D Kerbzange
 PL Nożyce dekarские do nacinania blach
 RUS Ножницы v-образные
 CZ Nůžky na plech vystřihování rohů
 H Lemezvágó olló

RO Foarfece tabla taierea colturii
 F Ciseaux à tôle
 I Cesoie per lamiera

E Cizallas para techos
 CN 缺口钳



230 mm 30° CrV

YATO	L (mm)	6/36
YT-18970	230	

GB Nail hole slot punch
 D Langlochzange
 PL Szczypce do sidingu do podłużnych otworów montażowych
 RUS Клещи для пробивки продольных отверстий
 CZ Klempířské kleště prošťňovací - oválné otvory

H Lyukasztó fogó vágó
 RO Clește pt. perforare - găuri ovale
 F Pince à poinçonner en oblong
 I Pinze per pannelli profilati per fori di montaggio oblungni

E Canteadeira conjugada com furador ovóide
 CN 腰型打孔钳



240 mm 15 x 3.5 mm CrV

YATO	L (mm)	6/36
YT-18975	240	

GB Snap lock punch
 D Schnappverschluss-Lochtreiber
 PL Zaciskacz punktowy
 RUS Плоскогубцы для кровельщиков
 CZ Střešní kleště

H Tetőfedő fogó
 RO Clește pt. despiciat
 F Pincés pour couvreurs

I Pinza a crimpare
 E Punzón de cerradura de resorte
 CN 记号钳



230 mm CrV

YATO	L (mm)	6/36
YT-18977	230	

- | | |
|--|---------------------------------------|
| GB Straight pliers | F Pince à fléchir la tôle |
| D Zange zum Blechbiegen | I Taglie per la lamiera |
| PL Kleszcze do gięcia blach | E Tenazas para doblar hojalata |
| RUS Клещи с тупым ножом для жести | CN 钣金钳 |
| CZ Kleště na ohýbání plechu | |
| H Falcfogó | |
| RO Cleste pt. indoirea tablei | |

COLOR
BOX



YATO	L (mm)	
YT-5416	280	10/20



YATO	L (mm)	
YT-5417	260	10/20



YATO	L (mm)	
YT-5415	280	10/20

Memo

18

**Power & gasoline tools
Elektronarzędzia
i narzędzia spalinowe**



Cordless tools
Narzędzia akumulatorowe

405-415



Planers
Strugi

422-423



Gasoline construction tools
Budowlane narzędzia spalinowe

416



Sabre saws
Piły szablaste

423



Impact wrenches
Klucze udarowe

416



Finishing sanders
Szlifierki oscylacyjne

423



Angle grinders
Szlifierki kątowe

416-417



Drywall sanders
Szlifierki do gładzi i tynków

423



Car polishers
Polerki samochodowe

417-418



Painting tools
Narzędzia do malowania

424



Cut-off machines
Przecinarki do metalu

418



Multi-purpose oscillating tools
Wielofunkcyjne narzędzia oscylacyjne

424-425



Drilling machines
Wiertarki

418-419



Vacuum cleaners
Odkurzacze

425-426



Drywall screwdrivers
Wkrętarki do regipsów

419



Knives
Noże

426



Diamond drills
Wiertnice diamentowe

419



Hot air guns
Opalarki

426-427



Rotary hammers
Młotowiertarki

420-421



Blowers
Dmuchawy

427



Demolition hammers
Młoty wyburzeniowe

421



Burners & soldering tools
Palniki i lutownice

427-429



Concrete vibrator sets
Wibratory do betonu

421



Glue guns
Pistolety do klejenia

429



Circular saws
Pilarki tarczowe

422



Pipe welders
Zgrzewarki do rur

429



Miter saws
Ukośnice

422



Generators
Generatory

430



Jig saws
Wyrzynarki

422



Pumps
Pompy

430-431



Cordless garden tools & accessories
Ogrodowe narzędzia akumulatorowe i akcesoria



431-434

Cordless chainsaws	
Akumulatorowe pilarki tańcuchowe	431
Cordless grass trimmers	
Akumulatorowe wykaszarki	432
Cordless hedge trimmers	
Akumulatorowe nożyce do żywopłotu	433

Electric garden tools
Ogrodowe narzędzia elektryczne



435

Electric lawn mowers	
Kosiarki elektryczne	435

Gasoline garden tools & accessories
Ogrodowe narzędzia spalinowe i akcesoria



435-442

Gasoline sprayers	
Opryskiwacze spalinowe	435
Gasoline chainsaws	
Pilarki spalinowe	435
Gasoline brushcutters	
Kosy spalinowe	436
Gasoline hedge trimmers	
Spalinowe nożyce do żywopłotu	436
Accessories	
Akcesoria	437

Electric hoists
Elektryczne wciągarki linowe



442

GB Cordless drill / driver
D Akkuschauber-und-bohrer
PL Akumulatorowa wiertarko-wkrętarka
RUS Аккумуляторная дрель с шурупвертом
CZ Akumulátorový vrtací šroubovák
H Akkus fúrőcsavarozók

RO Mașina de găurit / înșurubat cu acumulator
F Perceuse-visseuse sans-fil
I Trapano avvitatore a batteria
E Taladro / atomillador a batería
CN 充电式电钻



$L_{PA} = 83,14 \pm 3,0$ dB;
 $L_{WA} = 94,14 \pm 3,0$ dB;
 $a_s = 2,390 \pm 1,5 / 1,146 \pm 1,5$ m/s²

YATO	V	
YT-82901	12	5

BMC & COLOR SLEEVE

GB Cordless ratchet
D Akku-Ratsche
PL Grzechotka akumulatorowa
RUS Аккумуляторные импульсная трещотка
CZ Akumulátorový rázový utahovák
H Akkus ütvecsavarozó
RO Șurubelniță cu impact cu acumulator
F Clé à cliquet à batterie
I Cricchetto a batteria
E Llave de carraca a batería
CN 充电式扳手



$L_{PA} = 78,66 \pm 3,0$ dB;
 $L_{WA} = 89,66 \pm 3,0$ dB;
 $a_s = 2,898 \pm 1,5$ m/s²

COLOR BOX

YATO	V	
YT-82902	12	10

GB Cordless polisher
D Akku-Polierer
PL Polerka akumulatorowa
RUS Полировальная машина
CZ Akumulátorový leštič
H Vezeték nélküli polírózó

RO Polisher cu acumulator
F Polisseuse sans fil
I Lucidatrice a batteria
E Bateria pulidor
CN 充电式抛光机



COLOR BOX

$L_{PA} = 78,6 \pm 3,0$ dB;
 $L_{WA} = 89,6 \pm 3,0$ dB;
 $a_s = 4,213 \pm 1,5$ m/s²

YATO	V	
YT-82903	12	5

GB Cordless sabre saw
D Akku-Säbelsäge
PL Akumulatorowa piła szablsta
RUS Аккумуляторная сабельная пила
CZ Akumulátorová píla ocaskač
H Akkus szablyafűrész
RO Ferăstrău sabie cu acumulator
F Scie sabre sans-fil
I Sega a sciabola a batteria
E Sierra sable de batería
CN 充电式往复锯

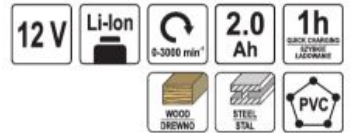

COLOR BOX

$L_{PA} = 83,58 \pm 3,0$ dB;
 $L_{WA} = 94,58 \pm 3,0$ dB;
 $a_s = 12,86 \pm 1,5 / 10,13 \pm 1,5 / 13,78 \pm 1,5 / 11,92 \pm 1,5$ m/s²

YATO	V	
YT-82904	12	6

GB Battery
D Akkumulator
PL Akumulator
RUS Аккумулятор
CZ Akumulátor
H Akkumulátor
RO Acumulatorul
F Batterie
I Batteria
E Bateria
CN 锂电池



COLOR BOX

YATO	V	
YT-82909	12	50

GB Cordless drill / driver
 D Akkuschauber-und-bohrer
 PL Akumulatorowa wiertarko-wkrętarła
 RUS Аккумуляторная дрель с шурупвертом
 CZ Akumulátorový vrtací šroubovák
 H Akkus fűrócsavarozók
 RO Maşina de găurit / înşurubat cu acumulator
 F Perceuse-visseuse sans-fil
 I Trapano avvitatore a batteria
 E Taladro / atornillador a batería
 CN 充电式电钻

18 V Li-Ion 40 Nm 0-440 min⁻¹ 0-1650 min⁻¹

2.0 Ah 1h QUICK CHARGING SYSTEM ŁADUNKOWE 13mm



$L_{pA} = 71,0 \pm 3,0$ dB;
 $L_{pM} = 82,0 \pm 3,0$ dB;
 $a_n = 3,0 \pm 1,5$ m/s²

COLOR BOX

YATO	V	
YT-82780	18	5

GB Cordless drill / driver (tool only)
 D Akkuschauber-und-bohrer (nur das Gerät)
 PL Akumulatorowa wiertarko-wkrętarła (tylko narzędzie)
 RUS Аккумуляторная дрель с шурупвертом (только инструмент)
 CZ Akumulátorový vrtací šroubovák (pouze nářadí)
 H Akkus fűrócsavarozók (csak a szerszámot)
 RO Maşina de găurit / înşurubat cu acumulator (numai sculă)
 F Perceuse-visseuse sans-fil (outil seulement)
 I Trapano avvitatore a batteria (solo utensile)
 E Taladro / atornillador a batería (herramienta solamente)
 CN 充电式电钻

18 V Li-Ion 40 Nm 0-440 min⁻¹ 0-1650 min⁻¹

1h* QUICK CHARGING SYSTEM ŁADUNKOWE 13mm



* given charging time is for 2.0 Ah battery only

$L_{pA} = 71,0 \pm 3,0$ dB;
 $L_{pM} = 82,0 \pm 3,0$ dB;
 $a_n = 3,0 \pm 1,5$ m/s²

battery not included
akumulatora nie dołączono

YATO	V	
YT-82781	18	5

GB Cordless drill / driver
 D Akkuschauber-und-bohrer
 PL Akumulatorowa wiertarko-wkrętarła
 RUS Аккумуляторная дрель с шурупвертом
 CZ Akumulátorový vrtací šroubovák
 H Akkus fűrócsavarozók
 RO Maşina de găurit / înşurubat cu acumulator
 F Perceuse-visseuse sans-fil
 I Trapano avvitatore a batteria
 E Taladro / atornillador a batería
 CN 充电式电钻

18 V Li-Ion 40 Nm 0-440 min⁻¹ 0-1650 min⁻¹

2.0 Ah 1h QUICK CHARGING SYSTEM ŁADUNKOWE 13mm



MABUCHI MOTOR SILNIK



$L_{pA} = 71,0 \pm 3,0$ dB;
 $L_{pM} = 82,0 \pm 3,0$ dB;
 $a_n = 3,0 \pm 1,5$ m/s²

BMC & COLOR SLEEVE

YATO	V	
YT-82782	18	4

GB Cordless drill / driver
 D Akkuschauber-und-bohrer
 PL Akumulatorowa wiertarko-wkrętarła
 RUS Аккумуляторная дрель с шурупвертом
 CZ Akumulátorový vrtací šroubovák
 H Akkus fűrócsavarozók
 RO Maşina de găurit / înşurubat cu acumulator
 F Perceuse-visseuse sans-fil
 I Trapano avvitatore a batteria
 E Taladro / atornillador a batería
 CN 充电式电钻

18 V Li-Ion 40 Nm 0-440 min⁻¹ 0-1650 min⁻¹

3.0 Ah 1h QUICK CHARGING SYSTEM ŁADUNKOWE 13mm



MABUCHI MOTOR SILNIK

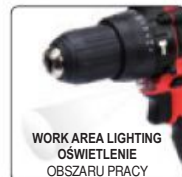

$L_{pA} = 71,0 \pm 3,0$ dB;
 $L_{pM} = 82,0 \pm 3,0$ dB;
 $a_n = 3,0 \pm 1,5$ m/s²

BMC & COLOR SLEEVE

YATO	V	
YT-82784	18	4

GB Cordless drill / driver (tool only)
D Akku-Schlagbohrschrauber (nur das Gerät)
PL Akumulatorowa wiertarko-wkrętarka (tylko narzędzie)
RUS Аккумуляторная дрель с шурупвертом (только инструмент)
CZ Akumulátorový vrtací šroubovák (pouze nářadí)
H Akkus fűrészarozók (csak a szerszámot)
RO Mașina de găurit / înșurubat cu acumulator (numai sculă)
F Perceuse-visseuse sans-fil (outil seulement)
I Trapano avvitatore a batteria (solo utensile)
E Taladro / atornillador a batería (herramienta solamente)
CN 充电式电钻



SPINDLE BRAKE

HAMULEC
WCZECIONA



WORK AREA LIGHTING
OŚWIETLENIE
OBSZARU PRACY

**MABUCHI
MOTOR
SILNIK**

18V
Li-Ion

COLOR
BOX



* given charging time is for 2.0 Ah battery only

* podany czas ładowania dotyczy tylko akumulatora 2.0 Ah

$L_{pA} = 71,0 \pm 3,0$ dB;
 $L_{wA} = 82,0 \pm 3,0$ dB;
 $a_n = 3,0 \pm 1,5 / 9,89 \pm 1,5$ m/s²

battery not included
akumulatora nie dołączono

YATO	V	
YT-82783	18	5

GB Cordless impact drill / driver
D Akku-Schlagbohrschrauber
PL Akumulatorowa wiertarko-wkrętarka udarowa
RUS Аккумуляторный ударный дрель-шурупверт
CZ Akumulátorový nárazový šroubovák s příklepem
H Akkus ütvefűrógép
RO Mașina de găurit cu percute și cu acumulator
F Perceuse-visseuse percussion sans-til
I Trapano avvitatore a percussione a batteria
E Taladro / atornillador con percusión a batería
CN 充电式冲击钻



SPINDLE BRAKE

HAMULEC
WCZECIONA



WORK AREA LIGHTING
OŚWIETLENIE
OBSZARU PRACY



$L_{pA} = 82,0 \pm 3,0$ dB;
 $L_{wA} = 93,0 \pm 3,0$ dB;
 $a_n = 3,0 \pm 1,5 / 9,89 \pm 1,5$ m/s²

18V
Li-Ion

COLOR
BOX

YATO	V	
YT-82786	18	5

GB Cordless impact drill / driver (tool only)
D Akku-Schlagbohrschrauber (nur das Gerät)
PL Akumulatorowa wiertarko-wkrętarka udarowa (tylko narzędzie)
RUS Аккумуляторная ударный дрель-шурупверт (только инструмент)
CZ Akumulátorový nárazový šroubovák s příklepem (pouze nářadí)
H Akkus ütvefűrógép (csak a szerszámot)
RO Mașină de găurit cu percute și cu acumulator (numai sculă)
F Perceuse-visseuse percussion sans-til (outil seulement)
I Trapano avvitatore a percussione a batteria (solo utensile)
E Taladro / atornillador con percusión a batería (herramienta solamente)
CN 充电式冲击钻 (光机)



SPINDLE BRAKE

HAMULEC
WCZECIONA



WORK AREA LIGHTING
OŚWIETLENIE
OBSZARU PRACY

18V
Li-Ion

COLOR
BOX



* given charging time is for 2.0 Ah battery only

* podany czas ładowania dotyczy tylko akumulatora 2.0 Ah

$L_{pA} = 82,0 \pm 3,0$ dB;
 $L_{wA} = 93,0 \pm 3,0$ dB;
 $a_n = 3,0 \pm 1,5 / 9,89 \pm 1,5$ m/s²

battery not included
akumulatora nie dołączono

YATO	V	
YT-82787	18	5

GB Cordless impact drill / driver
D Akku-Schlagbohrschrauber
PL Akumulatorowa wiertarko-wkrętarka udarowa
RUS Аккумуляторный ударный дрель-шурупверт
CZ Akumulátorový nárazový šroubovák s příklepem
H Akkus ütvefűrógép
RO Mașina de găurit cu percute și cu acumulator
F Perceuse-visseuse percussion sans-til
I Trapano avvitatore a percussione a batteria
E Taladro / atornillador con percusión a batería
CN 充电式冲击钻



SPINDLE BRAKE

HAMULEC
WCZECIONA



WORK AREA LIGHTING
OŚWIETLENIE
OBSZARU PRACY



$L_{pA} = 71,0 \pm 3,0$ dB;
 $L_{wA} = 82,0 \pm 3,0$ dB;
 $a_n = 3,0 \pm 1,5 / 9,89 \pm 1,5$ m/s²

18V
Li-Ion

BMC
& COLOR
SLEEVE

YATO	V	
YT-82788	18	4

GB Cordless impact drill / driver (tool only)
 D Akku-Schlagbohrschrauber (nur das Gerät)
 PL Akumulatorowa wiertarko-wkrętarka udarowa (tylko narzędzie)
 RUS Аккумуляторная ударный дрель-шурупверт (только инструмент)
 CZ Akumulátorový nárazový šroubovák s příklepem (pouze nářadí)
 H Akkus ütvefűrógép (csak a szerszámot)
 RO Mașină de găurit cu percuzie cu accumulator (numai scula)
 F Perceuse-visseuse percussion sans-fil (outil seulement)
 I Trapano avvitatore a percussione a batteria (solo utensile)
 E Taladro / atornillador con percusión a batería (herramienta solamente)
 CN 充电式冲击钻 (光机)

18 V Li-Ion 40 Nm 0-440 min⁻¹ 0-1650 min⁻¹ T 9-7320 min⁻¹ 0-29700 min⁻¹

1h* 13mm



MABUCHI MOTOR SILNIK



18V Li-Ion!

$L_{PA} = 71.0 \pm 3.0$ dB;
 $L_{WA} = 82.0 \pm 3.0$ dB;
 $a_s = 3.0 \pm 1.5 / 9.89 \pm 1.5$ m/s²

battery not included akumulatora nie dołączono

YATO	V	
YT-82789	18	5

GB Brushless cordless drill / driver
 D Bürstenloser Akku-Bohrschrauber
 PL Bezszczotkowa wiertarko-wkrętarka akumulatorowa
 RUS Бесщеточный аккумуляторный ударный дрель-шурупверт
 CZ Bezkartáčový akumulátorový vrtací šroubovák s příklepem
 H Sznékfe nélküli akkus fűrócsavarozók
 RO Mașină de găurit / înșurubat cu accumulator fără perii
 F Perceuse-visseuse sans-fil sans charbon
 I Trapano avvitatore senza spazzole a batteria
 E Taladro / atornillador a batería sin escobillas
 CN 充电式无刷电钻

18 V Li-Ion 42 Nm 0-600 min⁻¹ 0-2500 min⁻¹ T 0-19800 min⁻¹ 0-36000 min⁻¹

1h 13mm



18V Li-Ion!

$L_{PA} = 74.0 \pm 3.0$ dB;
 $L_{WA} = 85.0 \pm 3.0$ dB;
 $a_s = 3.0 \pm 1.5$ m/s²

BMC & COLOR SLEEVE

YATO	V	
YT-82794	18	4

GB Brushless cordless drill / driver (tool only)
 D Bürstenloser Akku-Bohrschrauber (nur das Gerät)
 PL Bezszczotkowa wiertarko-wkrętarka akumulatorowa (tylko narzędzie)
 RUS Бесщеточный аккумуляторный ударный дрель-шурупверт (только инструмент)
 CZ Bezkartáčový akumulátorový vrtací šroubovák s příklepem (pouze nářadí)
 H Sznékfe nélküli akkus fűrócsavarozók (csak a szerszámot)
 RO Mașină de găurit / înșurubat cu accumulator fără perii (numai scula)
 F Perceuse-visseuse sans-fil sans charbon (outil seulement)
 I Trapano avvitatore senza spazzole a batteria (solo utensile)
 E Taladro / atornillador a batería sin escobillas (herramienta solamente)
 CN 充电式无刷冲击钻 (光机)

18 V Li-Ion 42 Nm 0-600 min⁻¹ 0-2000 min⁻¹ T 0-19800 min⁻¹ 0-36000 min⁻¹

1h* 13mm



18V Li-Ion!

$L_{PA} = 74.0 \pm 3.0$ dB;
 $L_{WA} = 85.0 \pm 3.0$ dB;
 $a_s = 3.0 \pm 1.5$ m/s²

battery not included akumulatora nie dołączono

YATO	V	
YT-82795	18	5

GB Brushless cordless drill / driver
 D Bürstenloser Akku-Bohrschrauber
 PL Bezszczotkowa wiertarko-wkrętarka akumulatorowa
 RUS Бесщеточный аккумуляторный ударный дрель-шурупверт
 CZ Bezkartáčový akumulátorový vrtací šroubovák s příklepem
 H Sznékfe nélküli akkus fűrócsavarozók
 RO Mașină de găurit / înșurubat cu accumulator fără perii
 F Perceuse-visseuse sans-fil sans charbon
 I Trapano avvitatore senza spazzole a batteria
 E Taladro / atornillador a batería sin escobillas
 CN 充电式无刷电钻

18 V Li-Ion 42 Nm 0-600 min⁻¹ 0-2500 min⁻¹ T 0-19800 min⁻¹ 0-36000 min⁻¹

2.0 Ah 1h 13mm



18V Li-Ion!

$L_{PA} = 73.0 \pm 3.0$ dB;
 $L_{WA} = 94.0 \pm 3.0$ dB;
 $a_s = 3.0 \pm 1.5 / 9.56 \pm 1.5$ m/s²

BMC & COLOR SLEEVE

YATO	V	
YT-82796	18	4

- GB Brushless cordless drill / driver (tool only)
D Bürstenloser Akku-Bohrschrauber (nur das Gerät)
PL Bezszczotkowa wiertarko-wkrętarka akumulatorowa (tylko narzędzie)
RUS Бесщеточный аккумуляторный ударный дрель-шурупверт (только инструмент)
CZ Bezšcartočový akumulátorový vrtací šroubovák s přiklepem (pouze nářadí)
H Szénkefe nélküli akkus fúrócsavarozók (csak a szerszámot)
RO Mașină de găurit / înșurubat cu acumulator fără perii (numai sculă)
F Perceuse-visseuse sans-fil sans charbon (outil seulement)
I Trapano avvitatore senza spazzole a batteria (solo utensile)
E Taladro / atomillador a batería sin escobillas (herramienta solamente)
CN 充电式无刷冲击钻 (光机)

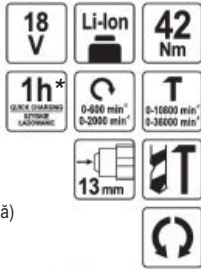

* given charging time is for 2.0 Ah battery only

* podany czas ładowania dotyczy tylko akumulatora 2.0 Ah

$L_{pA} = 73.0 \pm 3.0$ dB;
 $L_{pM} = 94.0 \pm 3.0$ dB;
 $a_{a0} = 3.0 \pm 1.5 / 9.56 \pm 1.5$ m/s²

battery not included
akumulatora nie dołączono

YATO	V	
YT-82797	18	5

- GB Cordless impact screwdriver
D Akku-Schlagbohrschrauber
PL Akumulatorowa zakrętkarka udarowa
RUS Аккумуляторный ударный гайковёрт
CZ Akumulátorový rázový utahovák
H Akkus ütvecsavarozó
RO Șurubelniță cu impact cu acumulator
F Boulonneuse sans-fil
I Avvitatore a percussione a batteria
E Atomillador de impacto a batería
CN 充电式冲击螺丝批



$L_{pA} = 82.0 \pm 3.0$ dB;
 $L_{pM} = 93.0 \pm 3.0$ dB;
 $a_{a0} = 8.15 \pm 1.5$ m/s²

COLOR BOX

YATO	V	
YT-82800	18	5

- GB Cordless impact screwdriver (tool only)
D Akku-Schlagbohrschrauber (nur das Gerät)
PL Akumulatorowa zakrętkarka udarowa (tylko narzędzie)
RUS Аккумуляторный ударный гайковёрт (только инструмент)
CZ Akumulátorový rázový utahovák (pouze nářadí)
H Akkus ütvecsavarozó (csak a szerszámot)
RO Șurubelniță cu impact cu acumulator (numai sculă)
F Boulonneuse sans-fil (outil seulement)
I Avvitatore a percussione a batteria (solo utensile)
E Atomillador de impacto a batería (herramienta solamente)
CN 充电式冲击螺丝批 (光机)



* given charging time is for 2.0 Ah battery only

* podany czas ładowania dotyczy tylko akumulatora 2.0 Ah

$L_{pA} = 82.0 \pm 3.0$ dB;
 $L_{pM} = 93.0 \pm 3.0$ dB;
 $a_{a0} = 8.15 \pm 1.5$ m/s²

battery not included
akumulatora nie dołączono

YATO	V	
YT-82801	18	5

- GB Cordless impact wrench
D Akku-DrehSchlagschrauber
PL Akumulatorowy klucz udarowy
RUS Аккумуляторный ударный гайковёрт
CZ Akumulátorový rázový utahovák
H Akkus ütvecsavarozó
RO Șurubelniță cu impact cu acumulator
F Boulonneuse sans-fil
I Chiave a percussione a batteria
E Atomillador de impacto a batería
CN 充电式冲击扳手



$L_{pA} = 84.0 \pm 3.0$ dB;
 $L_{pM} = 95.0 \pm 3.0$ dB;
 $a_{a0} = 9.09 \pm 1.5$ m/s²

BMC & COLOR SLEEVE

YATO	V	
YT-82804	18	4

- GB Cordless impact wrench (tool only)
- D Akku-DrehSchlagschrauber (nur das Gerät)
- PL Akumulatorowy klucz udarowy (tylko narzędzie)
- RUS Аккумуляторный ударный гайковёрт (только инструмент)
- CZ Akumulátorový rázový utahovák (pouze nářadí)
- H Akkus ütvecsavarozó (csak a szerszámot)
- RO Şurubelniţă cu impact cu acumulator (numai sculă)
- F Boulonneuse sans-fil (outil seulement)
- I Chiave a percussione a batteria (solo utensile)
- E Atornillador de impacto a batería (herramienta solamente)
- CN 充电式冲击扳手 (光机)

18 V Li-Ion 300 Nm 0-2200 rpm 0-2700 min⁻¹

1/2" 12.5mm 1h* LED 18V 16 x 16 x 2.4 (mm) 54 teeth 24T 90°-54mm 45°-40mm



18V Li-Ion!

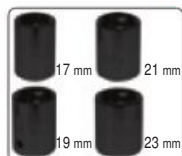

* given charging time is for 2.0 Ah battery only

* podany czas ładowania dotyczy tylko akumulatora 2.0 Ah

L_{WA} = 84,0 ± 3,0 dB;
L_{WA} = 95,0 ± 3,0 dB;
a_w = 9,09 ± 1,5 m/s²



battery not included
akumulatora nie dołączono

YATO	V	BOX
YT-82805	18	5

- GB Cordless screwdriver
- D Akku-schrauber
- PL Wkrętkak akumulatorowy
- RUS Аккумуляторный шуруповёрт
- CZ Akumulátorový utahovák
- H Akkus csavarbehajtó
- RO Şurubelniţă cu acumulator
- F Tournevis sans fil
- I Avvitatore a batteria
- E Herramienta de resistencia para soldar
- CN 充电式螺丝批

3.6 V Li-Ion 1300mAh 230 min⁻¹ 3.0 Nm

LED 18V 16 x 16 x 2.4 (mm) 54 teeth 24T 90°-54mm 45°-40mm



L_{WA} = 61,7 ± 3,0 dB;
L_{WA} = 72,7 ± 3,0 dB;
a_w = 0,39 ± 1,5 m/s²



YATO	V	BOX
YT-82760	3.6	20

- GB Cordless circular saw
- D Akku-Handkreissäge
- PL Akumulatorowa pilarka tarczowa
- RUS Аккумуляторная циркулярная пила
- CZ Akumulátorová okružní pila
- H Akkus körfűrész
- RO Ferăstrău circular cu acumulator
- F Scie circulaire sans-fil
- I Sega circolare a batteria
- E Sierra circular a batería
- CN 充电式电圆锯 (光机)

18 V Li-Ion 3800 min⁻¹ 2.0 Ah 1h* 18V 16 x 16 x 2.4 (mm) 54 teeth 24T 90°-54mm 45°-40mm



18V Li-Ion!

L_{WA} = 85,0 ± 3,0 dB;
L_{WA} = 96,0 ± 3,0 dB;
a_w = 5,33 ± 1,5 m/s²

YATO	V	BOX
YT-82810	18	2

- GB Cordless circular saw (tool only)
- D Akku-Handkreissäge (nur das Gerät)
- PL Akumulatorowa pilarka tarczowa (tylko narzędzie)
- RUS Аккумуляторная циркулярная пила (только инструмент)
- CZ Akumulátorová okružní pila (pouze nářadí)
- H Akkus körfűrész (csak a szerszámot)
- RO Ferăstrău circular cu acumulator (numai sculă)
- F Scie circulaire sans-fil (outil seulement)
- I Sega circolare a batteria (solo utensile)
- E Sierra circular a batería (herramienta solamente)
- CN 充电式电圆锯 (光机)

18 V Li-Ion 3800 min⁻¹ 2.0 Ah 1h* 18V 16 x 16 x 2.4 (mm) 54 teeth 24T 90°-54mm 45°-40mm



18V Li-Ion!

L_{WA} = 85,0 ± 3,0 dB;
L_{WA} = 96,0 ± 3,0 dB;
a_w = 5,33 ± 1,5 m/s²

* given charging time is for 2.0 Ah battery only

* podany czas ładowania dotyczy tylko akumulatora 2.0 Ah

battery not included
akumulatora nie dołączono

YATO	V	BOX
YT-82811	18	2

GB Cordless sabre saw
D Akku-Säbelsäge
PL Akumulatorowa piła szablasta
RUS Аккумуляторная шабельна пила
CZ Akumulátorová píla ocaska
H Akkus szablyafűrész
RO Ferăstrău sabie cu acumulator
F Scie sabre sans-fil
I Sega a gattuccio a batteria
E Sierra sable de batería
CN 充电式往复锯



$L_{pA} = 81,0 \pm 3,0$ dB;
 $L_{wA} = 92,0 \pm 3,0$ dB;
 $a_a = 7,5 \pm 1,5 / 8,3 \pm 1,5$ m/s²



COLOR BOX

YATO	V	
YT-82814	18	4

GB Cordless sabre saw (tool only)
D Akku-Säbelsäge (nur das Gerät)
PL Akumulatorowa piła szablasta (tylko narzędzie)
RUS Аккумуляторная шабельна пила (только инструмент)
CZ Akumulátorová píla ocaska (pouze nářadí)
H Akkus szablyafűrész (csak a szerszámot)
RO Ferăstrău sabie cu acumulator (numai scula)
F Scie sabre sans-fil (outil seulement)
I Sega a gattuccio a batteria (solo utensile)
E Sierra sable de batería (herramienta solamente)
CN 充电式往复锯 (光机)

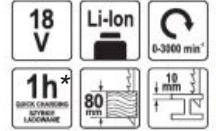

* given charging time is for 2.0 Ah battery only

* podany czas ładowania dotyczy tylko akumulatora 2.0 Ah

$L_{pA} = 81,0 \pm 3,0$ dB;
 $L_{wA} = 92,0 \pm 3,0$ dB;
 $a_a = 7,5 \pm 1,5 / 8,3 \pm 1,5$ m/s²

battery not included
akumulatora nie dołączono



COLOR BOX

YATO	V	
YT-82815	18	4

GB Multi-purpose oscillating tool
D Multifunktionales Oszillationswerkzeug
PL Wielofunkcyjne narzędzie oscylacyjne
RUS Многофункциональный инструмент
CZ Multifunkční oscilační nářadí
H Multifunkciós rezgő szerszám
RO Unealtă multifuncțională oscilantă
F Outil multifonctions oscillant
I Oscillante strumento multifunzione
E Herramienta oscilatoria multiusos
CN 多功能啊雄莓



$L_{pA} = 78,20 \pm 3,0$ dB;
 $L_{wA} = 89,20 \pm 3,0$ dB;
 $a_a = 1,609 \pm 1,5 / 2,503 \pm 1,5$ m/s²

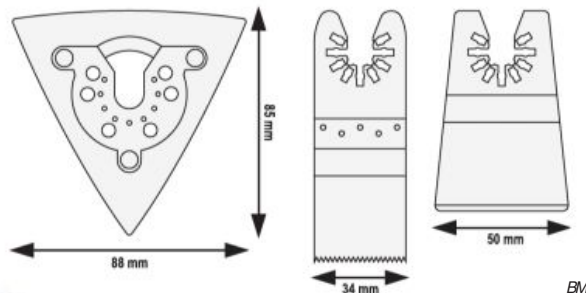

CUTTING / CIĘCIE

SANDING / SZLIFOWANIE

SCRAPING / ZDRAPYWANIE



additional battery in set
dodatkowy akumulator w zestawie

BMC & COLOR SLEEVE



YATO	V	
YT-82900	10.8	5

GB Battery
D Akkumulator
PL Akumulator
RUS Аккумулятор
CZ Akumulátor
H Akkumulátor
RO Acumulatorul
F Batterie
I Batteria
E Bateria
CN 锂电池



WHITE CARTON BOX & COLOR LABEL



for / dla: YT-82850, YT-82900

YATO	V	
YT-82857	10.8	40

- GB Cordless multi-purpose oscillating tool
- D Akku-Multifunktionswerkzeug
- PL Akumulatorowe wielofunkcyjne narzędzie oscylacyjne
- RUS Аккумуляторный многофункциональный инструмент
- CZ Akumulátorová multifunkční pila
- H Akkus multifunkcionális vágószerszám
- RO Mașină multifuncțională cu acumulator
- F Découpeur-ponceur multifonctions sans-fil
- I Utensile oscillante multifunzione a batteria
- E Multiherramienta a batería
- CN 充电式多功能锯



18V
Li-Ion

18 V	Li-Ion	8000-19000 rpm	
2.0 Ah	1h	QUICK CHARGED BATTERY TECHNOLOGY	

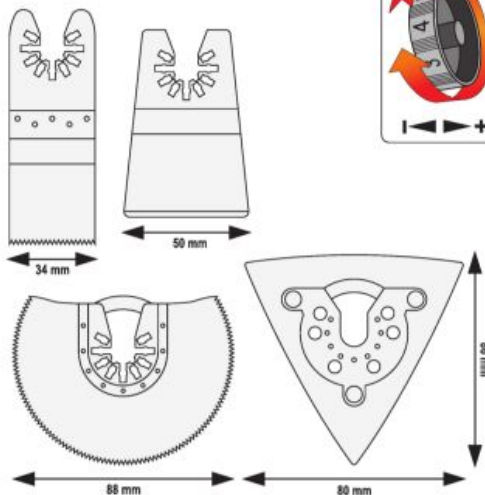

CUTTING / CIĘCIE	CUTTING / CIĘCIE	SANDING / SZLIFOWANIE	SCRAPING / ZDRAPYWANIE

$L_{wA} = 77,0 \pm 3,0$ dB;
 $L_{wA} = 88,0 \pm 3,0$ dB;
 $a_n = 4,68 \pm 1,5$ m/s²

YATO	V	
YT-82818	18	4



COLOR BOX

- GB Cordless multi-purpose oscillating tool (tool only)
- D Akku-Multifunktionswerkzeug (nur das Gerät)
- PL Akumulatorowe wielofunkcyjne narzędzie oscylacyjne (tylko narzędzie)
- RUS Аккумуляторный многофункциональный инструмент (только инструмент)
- CZ Akumulátorová multifunkční pila (pouze nářadí)
- H Akkus multifunkcionális vágószerszám (csak a szerszámot)
- RO Mașină multifuncțională cu acumulator (numai sculă)
- F Découpeur-ponceur multifonctions sans-fil (outil seulement)
- I Utensile oscillante multifunzione a batteria (solo utensile)
- E Multiherramienta a batería (herramienta solamente)
- CN 充电式多功能锯 (光机)



18V
Li-Ion

18 V	Li-Ion	
8000-19000 rpm	1h*	

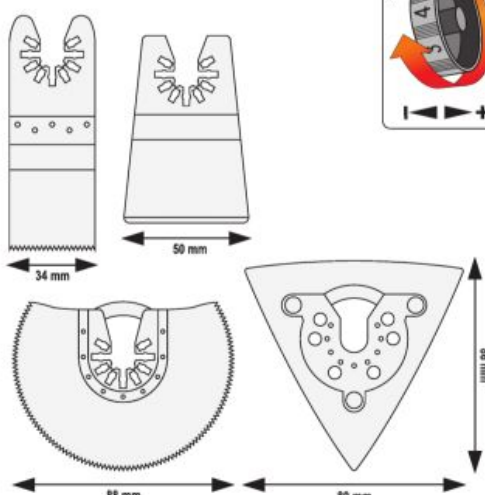

CUTTING / CIĘCIE	CUTTING / CIĘCIE	SANDING / SZLIFOWANIE	SCRAPING / ZDRAPYWANIE

* given charging time is for 2.0 Ah battery only
* podany czas ładowania dotyczy tylko akumulatora 2.0 Ah

battery not included
akumulatora nie dołączono

$L_{wA} = 77,0 \pm 3,0$ dB;
 $L_{wA} = 88,0 \pm 3,0$ dB;
 $a_n = 4,68 \pm 1,5$ m/s²

YATO	V	
YT-82819	18	8



COLOR BOX

- GB Cordless jig saw
D Akku-Stichsäge
PL Akumulatorowa wyrzynarka
RUS Аккумуляторная лобзиковая пила
CZ Akumulátorová přímočará pila
H Akkus szűrőfűrész
RO Ferăstrău vertical cu acumulator
F Scie sauteuse sans-fil
I Seghetto alternativo a batteria
E Sierra de calar a batería
CN 充电式曲线锯



18V
Li-Ion!



$L_{pA} = 76,0 \pm 3,0$ dB;
 $L_{mA} = 87,0 \pm 3,0$ dB;
 $a_n = 6,28 \pm 1,5 / 5,78 \pm 1,5$ m/s²

COLOR BOX

YATO	V	
YT-82822	18	4



- GB Cordless jig saw (tool only)
D Akku-Stichsäge (nur das Gerät)
PL Akumulatorowa wyrzynarka (tylko narzędzie)
RUS Аккумуляторная лобзиковая пила (только инструмент)
CZ Akumulátorová přímočará pila (pouze nářadí)
H Akkus szűrőfűrész (csak a szerszámot)
RO Ferăstrău vertical cu acumulator (numai sculă)
F Scie sauteuse sans-fil (outil seulement)
I Seghetto alternativo a batteria (solo utensile)
E Sierra de calar a batería (herramienta solamente)
CN 充电式曲线锯 (光机)

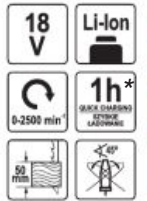

18V
Li-Ion!



$L_{pA} = 76,0 \pm 3,0$ dB;
 $L_{mA} = 87,0 \pm 3,0$ dB;
 $a_n = 6,28 \pm 1,5 / 5,78 \pm 1,5$ m/s²

COLOR BOX

YATO	V	
YT-82823	18	5



* given charging time is for 2.0 Ah battery only
battery not included
akumulatora nie dołączono

* podany czas ładowania dotyczy tylko akumulatora 2.0 Ah

- GB Cordless angle grinder
D Akku-Winkelschleifer
PL Akumulatorowa szlifierka kątowa
RUS Аккумуляторная угловая шлифмашина
CZ Akumulátorová úhlová bruska
H Akkus sarokcsiszoló
RO Polizor unghiular cu acumulator
F Meuleuse angulaire sans-fil
I Smeraglatrice angolare a batteria
E Amoladora angular a batería
CN 充电式角磨

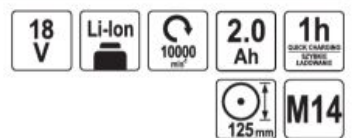

18V
Li-Ion!

$L_{pA} = 88,0 \pm 3,0$ dB;
 $L_{mA} = 99,0 \pm 3,0$ dB;
 $a_n = 4,9 \pm 1,5$ m/s²

COLOR BOX

YATO	V	
YT-82826	18	4

- GB Cordless angle grinder
D Akku-Winkelschleifer
PL Akumulatorowa szlifierka kątowa
RUS Аккумуляторная угловая шлифмашина
CZ Akumulátorová úhlová bruska
H Akkus sarokcsiszoló
RO Polizor unghiular cu acumulator
F Meuleuse angulaire sans-fil
I Smeraglatrice angolare a batteria
E Amoladora angular a batería
CN 充电式角磨



18V
Li-Ion!

$L_{pA} = 88,0 \pm 3,0$ dB;
 $L_{mA} = 99,0 \pm 3,0$ dB;
 $a_n = 4,9 \pm 1,5$ m/s²

COLOR BOX

YATO	V	
YT-82828	18	4



- GB Cordless angle grinder (tool only)
D Akku-Winkelschleifer (nur das Gerät)
PL Akumulatorowa szlifierka kątowa (tylko narzędzie)
RUS Аккумуляторная угловая шлифмашина (только инструмент)
CZ Akumulátorová úhlová bruska (pouze nářadí)
H Akkus sarokcsiszoló (csak a szerszámot)
RO Polizor unghiular cu acumulator (numai sculă)
F Meuleuse angulaire sans-fil (outil seulement)
I Smeraglatrice angolare a batteria (solo utensile)
E Amoladora angular a batería (herramienta solamente)
CN 充电式角磨 (光机)



18V
Li-Ion!

$L_{pA} = 88,0 \pm 3,0$ dB;
 $L_{mA} = 99,0 \pm 3,0$ dB;
 $a_n = 4,9 \pm 1,5$ m/s²

COLOR BOX

YATO	V	
YT-82827	18	6

* given charging time is for 2.0 Ah battery only
* podany czas ładowania dotyczy tylko akumulatora 2.0 Ah

battery not included
akumulatora nie dołączono

- GB Cordless rotary hammer
- D Akku-Bohrhammer
- PL Akumulatorowa młotowiertarka
- RUS Аккумуляторный перфоратор
- CZ Akumulátorové vrtací kladivo
- H Akkus fúrókalapács
- RO Ciocan rotopercutor cu acumulator
- F Marteau-perforateur rotatif sans-fil
- I Trapano a percussione a batteria
- E Martillo perforador a batería
- CN 充电式电锤



18 V	Li-Ion	0-1850 rpm	0-4800 mm/s	SDS PLUS
3.0 Ah	2.0 J	18 mm		



18V
Li-Ion

BMC & COLOR SLEEVE



$L_{pa} = 83.0 \pm 3.0 / 91.0 \pm 3.0$ dB;
 $L_{ma} = 94.0 \pm 3.0 / 102.0 \pm 3.0$ dB;
 $a_n = 16.9 \pm 1.5 / 15.9 \pm 1.5$ m/s²

YATO	V	
YT-82770	18	3

- GB Cordless grass trimmer
- D Akku-Rasentrimmer
- PL Akumulatorowa podkaszarka do trawy
- RUS Аккумуляторный триммер
- CZ Akumulátorová sekačka na trávu
- H Akkus szegélynyíró
- RO Trimmere de gazon cu acumulator
- F Débroussaillseuse sans-fil
- I Tagliabordi a batteria
- E Desbrozadora a batería
- CN 充电式打草机

18 V	Li-Ion	7200 rpm	2.0 Ah	1h QUICK CHARGING SYSTEM LAZARUS
				250/300 mm

- GB Cordless grass trimmer (tool only)
- D Akku-Rasentrimmer (nur das Gerät)
- PL Akumulatorowa podkaszarka do trawy (tylko narzędzie)
- RUS Аккумуляторный триммер (только инструмент)
- CZ Akumulátorová sekačka na trávu (pouze nářadí)
- H Akkus szegélynyíró (csak a szerszámot)
- RO Trimmere de gazon cu acumulator (numai sculă)
- F Débroussaillseuse sans-fil (outil seulement)
- I Tagliabordi a batteria (solo utensile)
- E Desbrozadora a batería (herramienta solamente)
- CN 充电式打草机 (光机)

18 V	Li-Ion	7200 rpm	1h* QUICK CHARGING SYSTEM LAZARUS
			250/300 mm



$L_{pa} = 85.0 \pm 3.0$ dB;
 $L_{ma} = 93.0 \pm 3.0$ dB;
 $a_n = 2.5 \pm 1.5$ m/s²

YATO	V	
YT-82830	18	2

COLOR BOX



battery not included
akumulatora nie dołączono

* given charging time is for 2.0 Ah battery only

* podany czas ładowania dotyczy tylko akumulatora 2.0 Ah

$L_{pa} = 85.0 \pm 3.0$ dB;
 $L_{ma} = 93.0 \pm 3.0$ dB;
 $a_n = 2.5 \pm 1.5$ m/s²

YATO	V	
YT-82831	18	2

COLOR BOX

- GB Cordless hedge trimmer
- D Akku-Heckenschere
- PL Akumulatorowe nożyce do żywopłotu
- RUS Аккумуляторный кусторез
- CZ Akumulátorové nožky na živé ploty
- H Akkus sövénynyíró
- RO Foarfece de tăiat gard viu cu acumulator
- F Taille-haies sans-fil
- I Tagliasiepi a batteria
- E Cortasetos inalámbrico
- CN 充电式高枝剪

18 V	Li-Ion	2.0 Ah	1h QUICK CHARGING SYSTEM LAZARUS
		1050 min	560 mm
			22"

- GB Cordless hedge trimmer (tool only)
- D Akku-Heckenschere (nur das Gerät)
- PL Akumulatorowe nożyce do żywopłotu (tylko narzędzie)
- RUS Аккумуляторный кусторез (только инструмент)
- CZ Akumulátorové nožky na živé ploty (pouze nářadí)
- H Akkus sövénynyíró (csak a szerszámot)
- RO Foarfece de tăiat gard viu cu acumulator (numai sculă)
- F Taille-haies sans-fil (outil seulement)
- I Tagliasiepi a batteria (solo utensile)
- E Cortasetos inalámbrico (herramienta solamente)
- CN 充电式高枝剪 (光机)

18 V	Li-Ion	1h* QUICK CHARGING SYSTEM LAZARUS
		1050 min
		560 mm
		22"



$L_{pa} = 80.0 \pm 3.0$ dB;
 $L_{ma} = 87.0 \pm 3.0$ dB;
 $a_n = 3.5 \pm 1.5$ m/s²

YATO	V	
YT-82832	18	2

COLOR BOX



battery not included
akumulatora nie dołączono

* given charging time is for 2.0 Ah battery only
* podany czas ładowania dotyczy tylko akumulatora 2.0 Ah

$L_{pa} = 80.0 \pm 3.0$ dB;
 $L_{ma} = 87.0 \pm 3.0$ dB;
 $a_n = 3.5 \pm 1.5$ m/s²

YATO	V	
YT-82833	18	2

COLOR BOX

- GB Cordless hedge trimmer
D Akku-Heckenschere
PL Akumulatorowe nożyce do żywopłotu
RUS Аккумуляторный кусторез
CZ Akumulátorové nůžky na živé ploty
H Akkus sövényníró
RO Foarfece de tăiat gard viu cu acumulator
F Taille-haies sans-fil
I Tagliasiepi a batteria
E Tijera cortasetos a batería
CN 充电式高枝剪



$L_{pA} = 77,3 \pm 3,0$ dB;
 $L_{pM} = 88,1 \pm 3,0$ dB;
 $a_s = 1,5 \pm 1,5$ m/s²

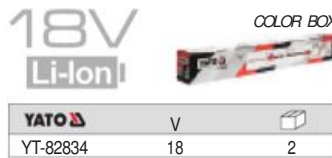
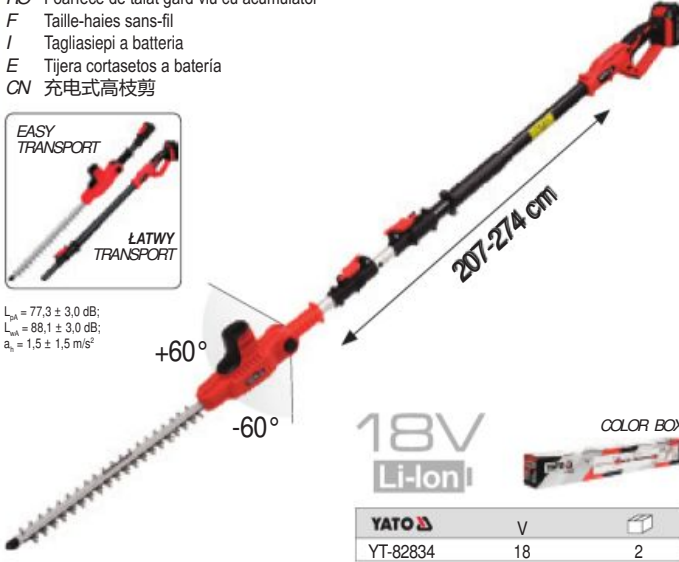

- GB Cordless hedge trimmer (tool only)
D Akku-Heckenschere (nur das Gerät)
PL Akumulatorowe nożyce do żywopłotu (tylko narzędzie)
RUS Аккумуляторный кусторез (только инструмент)
CZ Akumulátorové nůžky na živé ploty (pouze nářadí)
H Akkus sövényníró (csak a szerszámot)
RO Foarfece de tăiat gard viu cu acumulator (numai sculă)
F Taille-haies sans-fil (outil seulement)
I Tagliasiepi a batteria (solo utensile)
E Tijera cortasetos a batería (herramienta solamente)
CN 充电式高枝剪 (光机)



$L_{pA} = 77,3 \pm 3,0$ dB;
 $L_{pM} = 88,1 \pm 3,0$ dB;
 $a_s = 1,5 \pm 1,5$ m/s²

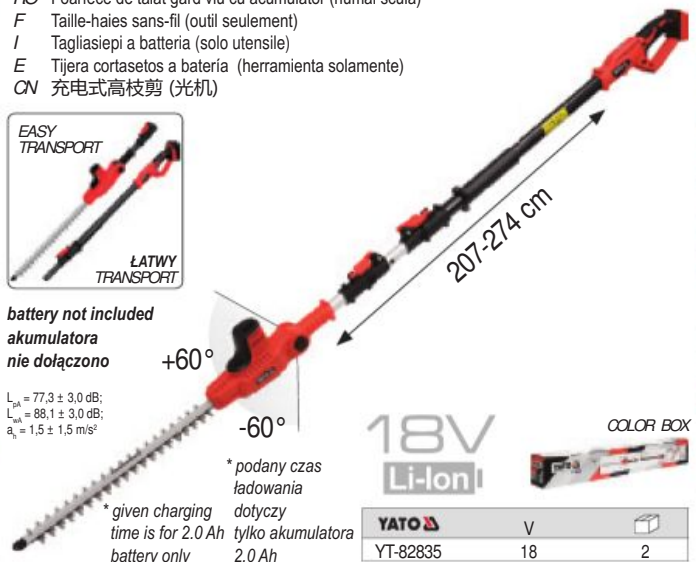

battery not included
akumulatora
nie dołączono
* podany czas ładowania dotyczy tylko akumulatora 2.0 Ah
* given charging time is for 2.0 Ah battery only

- GB Cordless telescopic pole saw
D Akku-Teleskop-Hochtaster
PL Akumulatorowe okrzesywarka na wysięgniku
RUS Аккумуляторный телескопический высоторез
CZ Akumulátorová teleskopická vyvėtovací pila
H Akkus magassági ágvgó távcsőves
RO Ferăstraie cu lanț cu telescopic cu acumulator
F Elagueuse sur perche télescopique sans-fil
I Decescpugliatore telescopico a batteria
E Sierra de pértiga telescópica a batería
CN 充电式高枝锯



$L_{pA} = 78,2 \pm 3,0$ dB;
 $L_{pM} = 91,2 \pm 2,36$ dB;
 $a_s = 2,109 \pm 1,5$ m/s²

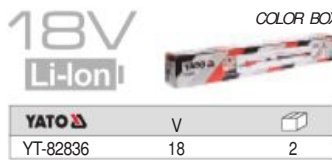

- GB Cordless telescopic pole saw (tool only)
D Akku-Teleskop-Hochtaster (nur das Gerät)
PL Akumulatorowe okrzesywarka na wysięgniku (tylko narzędzie)
RUS Аккумуляторный телескопический высоторез (только инструмент)
CZ Akumulátorová teleskopická vyvėtovací pila (pouze nářadí)
H Akkus magassági ágvgó távcsőves (csak a szerszámot)
RO Ferăstraie cu lanț cu telescopic cu acumulator (numai sculă)
F Elagueuse sur perche télescopique sans-fil (outil seulement)
I Decescpugliatore telescopico a batteria (solo utensile)
E Sierra de pértiga telescópica a batería (herramienta solamente)
CN 充电式高枝锯 (光机)



$L_{pA} = 78,2 \pm 3,0$ dB;
 $L_{pM} = 91,2 \pm 2,36$ dB;
 $a_s = 2,109 \pm 1,5$ m/s²

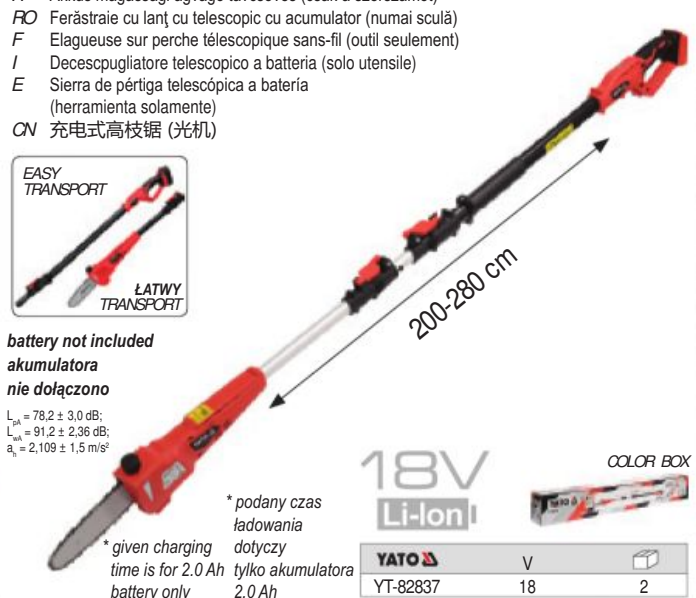

battery not included
akumulatora
nie dołączono
* podany czas ładowania dotyczy tylko akumulatora 2.0 Ah
* given charging time is for 2.0 Ah battery only

- GB Battery
D Akkumulator
PL Akumulator
RUS Аккумулятор
CZ Akumulátor
H Akkumulátor
RO Acumulatorul
F Batterie
I Batteria
E Bateria
CN 锂电池



YATO	V	capacity / pojemność (Ah)	charging time / czas ładowania (h)	
YT-82842	18	2.0	1.0	20
YT-82843	18	3.0	1.5	20
YT-82844	18	4.0	2.0	20

- GB Battery charger
D Ladegerät
PL Ładowarka
RUS Зарядное устройство
CZ Nabíječka
H Akkutöltő
RO Redresor
F Chargeur de batterie
I Caricabatteria
E Rectificador
CN 充电器



YATO	V	
YT-82848	18	10

- GB Power cutter
- D Trennschleifer
- PL Przecinarka spaliniowa
- RUS Бензиновый бензорез
- CZ Rozbrušovací pila
- H Beton- és fémdarabolók
- RO Motodebitator
- F Découpeuse
- I Troncatrice con motore a combustione interna
- E La cortadora
- CN 汽油切割机



4 kW	4700 rpm	93.6 cm ²	Ø 48 x 25.4 mm
1/2" 12.5 mm	145 mm	40 : 1	1 L



Disc not included
Tarczy nie dołączono

L_{pa} = 93.35 ± 2.5 / 107.95 ± 2.5 dB;
L_{wa} = 112.33 ± 2.5 / 115.5 ± 2.5 dB;
a_v = 10.26 ± 1.5 / 9.77 ± 1.5 / 6.99 ± 1.5 / 7.79 ± 1.5 m/s²

YATO	kW	
YT-84820	4	1

- GB Electric impact wrench
- D Elektro-Schlagschrauber
- PL Elektryczny klucz udarowy
- RUS Электрический гайковерт
- CZ Elektrický rázový utahovák
- H Elektromos ütvecsavarozó
- RO Pistol de impact electric
- F Clé à choc électrique
- I Avvitatore elettrico ad impulso
- E llave de impacto eléctrica
- CN 电动冲击扳手

230V~50Hz	450 W	450 Nm	0-3300 rpm	T 0-3300 mm ²
1/2" 12.5mm	17, 19, 21, 22 mm	4m		



L_{pa} = 96 ± 3 dB;
L_{wa} = 107 ± 3 dB;
a_v = 17.648 ± 1.5 m/s²

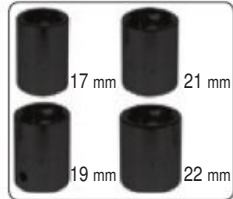

BMC & COLOR SLEEVE

YATO	W	
YT-82020	450	5

- GB Electric impact wrench
- D Elektro-Schlagschrauber
- PL Elektryczny klucz udarowy
- RUS Электрический гайковерт
- CZ Elektrický rázový utahovák
- H Elektromos ütvecsavarozó
- RO Pistol de impact electric
- F Clé à choc électrique
- I Avvitatore elettrico ad impulso
- E llave de impacto eléctrica
- CN 电动冲击扳手

230V~50Hz	1020 W	600 Nm	0-2600 rpm	T 2700 mm ²
1/2" 12.5mm	17, 19, 21, 22 mm	4m		



L_{pa} = 100 ± 3 dB;
L_{wa} = 111 ± 3 dB;
a_v = 18.9 ± 1.5 m/s²

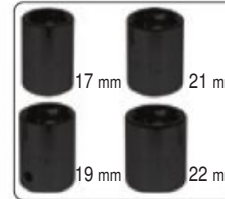

BMC & COLOR SLEEVE

YATO	W	
YT-82021	1020	3

- GB Angle grinder
- D Winkelschleifmaschine
- PL Szlifierka kątowa
- RUS Угловой шлифовальный станок
- CZ Úhlová bruska
- H Sarokcsiszoló
- RO Polizor unghiular
- F Meuleuse d'angle
- I Smeligiatrice angolare
- E Lijadera de angulo
- CN 角向磨光机

230V~50Hz	720 W	11500 rpm
115mm	M14	



COLOR BOX

L_{pa} = 87.6 ± 3.0 dB;
L_{wa} = 98.6 ± 3.0 dB;
a_v = 5.437 ± 1.5 / 6.134 ± 1.5 m/s²

YATO	W	
YT-82091	720	8

- GB Angle grinder
- D Winkelschleifmaschine
- PL Szlifierka kątowa
- RUS Угловой шлифовальный станок
- CZ Úhlová bruska
- H Sarokcsiszoló
- RO Polizor unghiular
- F Meuleuse d'angle
- I Smeligiatrice angolare
- E Lijadera de angulo
- CN 角向磨光机

230V~50Hz	850 W	12000 rpm
125mm	M14	



COLOR BOX

L_{pa} = 87.3 ± 3.0 dB;
L_{wa} = 98.3 ± 3.0 dB;
a_v = 3.378 ± 1.5 / 4.746 ± 1.5 m/s²

YATO	W	
YT-82097	850	6

GB Angle grinder
D Winkelschleifmaschine
PL Szlifierka kątowa
RUS Угловой шлифовальный станок
CZ Úhlová bruska

H Sarokcsiszoló
RO Polizor unghiular
F Meuleuse d'angle
I Smeligiatrice angolare
E Lijadera de angulo
CN 角向磨光机



COLOR BOX



$L_{pA} = 87,37 \pm 3,0$ dB;
 $L_{wA} = 98,37 \pm 3,0$ dB;
 $a_s = 7,131 \pm 1,5 / 5,852 \pm 1,5$ m/s²

YATO	W	Box
YT-82094	850	10

GB Angle grinder
D Winkelschleifmaschine
PL Szlifierka kątowa
RUS Угловой шлифовальный станок
CZ Úhlová bruska

H Sarokcsiszoló
RO Polizor unghiular
F Meuleuse d'angle
I Smeligiatrice angolare
E Lijadera de angulo
CN 角向磨光机



COLOR BOX



$L_{pA} = 79,0 \pm 3,0$ dB;
 $L_{wA} = 90,0 \pm 3,0$ dB;
 $a_s = 3,98 \pm 1,5$ m/s²

YATO	W	Box
YT-82100	1100	6

GB Angle grinder
D Winkelschleifmaschine
PL Szlifierka kątowa
RUS Угловой шлифовальный станок
CZ Úhlová bruska

H Sarokcsiszoló
RO Polizor unghiular
F Meuleuse d'angle
I Smeligiatrice angolare
E Lijadera de angulo
CN 角向磨光机



COLOR BOX



$L_{pA} = 84,3 \pm 3,0$ dB;
 $L_{wA} = 95,3 \pm 3,0$ dB;
 $a_s = 6,743 \pm 1,5$ m/s²

YATO	W	Box
YT-82101	1100	8

GB Angle grinder
D Winkelschleifmaschine
PL Szlifierka kątowa
RUS Угловой шлифовальный станок
CZ Úhlová bruska

H Sarokcsiszoló
RO Polizor unghiular
F Meuleuse d'angle
I Smeligiatrice angolare
E Lijadera de angulo
CN 角向磨光机



COLOR BOX



$L_{pA} = 99,75 \pm 3,0$ dB;
 $L_{wA} = 110,75 \pm 3,0$ dB;
 $a_s = 6,398 \pm 1,5 / 9,277 \pm 1,5$ m/s²

YATO	W	Box
YT-82103	2100	2

GB Angle grinder
D Winkelschleifmaschine
PL Szlifierka kątowa
RUS Угловой шлифовальный станок
CZ Úhlová bruska
H Sarokcsiszoló
RO Polizor unghiular
F Meuleuse d'angle
I Smeligiatrice angolare
E Lijadera de angulo
CN 角向磨光机



COLOR BOX



$L_{pA} = 91,8 \pm 3,0$ dB;
 $L_{wA} = 102,8 \pm 3,0$ dB;
 $a_s = 4,478 \pm 1,5 / 4,956 \pm 1,5$ m/s²

YATO	W	Box
YT-82110	2800	2

GB Car polisher
D Autopoliermaschine
PL Polerka samochodowa
RUS Полировальная машина
CZ Leštička na automobily
RO Masina de lustruit automobile

F Polisseur de voiture
I Levigatrice rotoorbitale
E Maquina para pulir coches
CN 抛光机



BMC & COLOR SLEEVE



ADDITIONAL PADS / DODATKOWE KRAŽKI



$L_{pA} = 85,0 \pm 3,0$ dB;
 $L_{wA} = 96,0 \pm 3,0$ dB;
 $a_s = 5,56 \pm 1,5$ m/s²

YATO	W	Box
YT-82200	720	4

- GB Car polisher
D Autopoliermaschine
PL Polerka samochodowa
RUS Полировальная машина
CZ Leštíčka na automobily
H Gépkocsi polírozógép
RO Masina de lustruit automobile
- F Polisseur de voiture
I Levigatrice
PL rotoorbitalna
E Maquina para pulir coches
CN 抛光机



220-240V-50Hz
1200 W
600-3000 rpm
180 mm
M14
5m
5m



BMC & COLOR SLEEVE

L_{pa} = 84,54 ± 3,0 dB;
L_{wa} = 95,54 ± 3,0 dB;
a_w = 12,063 ± 1,5 / 19,086 ± 1,5 m/s²

YATO	W	
YT-82195	1200	3

- GB Grinding wheel cutter for metal
D Trennschleifer für Metall
PL Przecinarka ściernicowa do metalu
RUS Абразивно-отрезной станок по металлу
CZ Rozbrušovací pila na kovy
H Gyorsdaraboló fémhez
RO Ferăstrău abraziv pt. metal
F Scie a métaux
I Trapano a percussione
E Cortador abrasivo para metalesn
CN 型材切割机

230V~50Hz
2450 W
4000 rpm
Ø 150x25,4
0-45° CUTTING ANGLE DEGREE FOR MOTOR
SOFT START MIEKKI START
LONG LIFE MOTOR TRWALY SILNIK



COLOR BOX

L_{pa} = 95,8 ± 3,0 dB;
L_{wa} = 108,8 ± 3,0 dB

YATO	W	
YT-82181	2450	1

- GB Band saw
D Bandsäge
PL Pila taśmowa
RUS Ленточные пилы
- CZ Pásová pila
H Szalagfűrész
RO Ferastrau cu banda
F Scie à ruban
- I Seg a nastro
E Sierra de cinta
CN 带锯

220-240V-50Hz
1100 W
0.7-2.4 m/s
14 TPI
1140 x 12.7 x 0.6 mm BLADE OSTRZE
127x127 mm CUTTING RANGE ZABIEG CIECIA
3m
5m

L_{pa} = 89 ± 3 dB;
L_{wa} = 100 ± 3 dB;
a_w = 6,62 ± 1,5 / 6,08 ± 1,5 m/s²



BMC & COLOR BOX



YATO	W	
YT-82185	1100	1

- GB Impact drill
D Schlagbohrmaschine
PL Wiertarka udarowa
RUS Ударная дрель
CZ Nárazová vrtačka
H Kezelési utasítás
RO Masina de gaurit
F Perceuse à percussion
I Trapano a percussione
E Taladradora de percusión
CN 冲击钻

220-240V-50Hz
710 W
0-2800 rpm
0-44000 min⁻¹
25 mm
13 mm
3m
5m



COLOR BOX

L_{pa} = 80,0 ± 3,0 dB;
L_{wa} = 91,0 ± 3,0 dB;
a_w = 2,95 ± 1,5 / 8,46 ± 1,5 m/s²

YATO	W	
YT-82034	710	5

- GB Impact drill
D Schlagbohrmaschine
PL Wiertarka udarowa
RUS Ударная дрель
CZ Nárazová vrtačka
H Kezelési utasítás
RO Masina de gaurit
F Perceuse à percussion
I Trapano a percussione
E Taladradora de percusión
CN 冲击钻

220-240V-50Hz
810 W
0-2800 rpm
0-44000 min⁻¹
25 mm
13 mm
3m
5m



COLOR BOX

L_{pa} = 87,0 ± 3,0 dB;
L_{wa} = 98,0 ± 3,0 dB;
a_w = 2,29 ± 1,5 / 8,50 ± 1,5 m/s²

YATO	W	
YT-82036	810	5

GB Impact drill
D Schlagbohrmaschine
PL Wiertarka udarowa
RUS Ударная дрель
CZ Nárazová vrtačka
H Kezelési utasítás
RO Masina de gaurit
F Perceuse à percussion
I Trapano a percussione
E Taladradora de percusión
CN 冲击钻



YATO	W	
YT-82037	850	5

L_{pa} = 89,0 ± 3,0 dB;
L_{wa} = 100,0 ± 3,0 dB;
a_v = 2,39 ± 1,5 / 8,78 ± 1,5 m/s²

GB Impact drill
D Schlagbohrmaschine
PL Wiertarka udarowa
RUS Ударная дрель
CZ Nárazová vrtačka
H Kezelési utasítás
RO Masina de gaurit
F Perceuse à percussion
I Trapano a percussione
E Taladradora de percusión
CN 冲击钻



YATO	W	
YT-82044	1050	5

L_{pa} = 97,0 ± 3,0 dB;
L_{wa} = 108,0 ± 3,0 dB;
a_v = 2,85 ± 1,5 / 10,1 ± 1,5 m/s²

GB Electric drill
D Elektrobohrmaschine
PL Wiertarka elektryczna
RUS Электрическая дрель
CZ Elektrická vrtačka
H Elektromos fúrógép
RO Mașină de găurit electrică
F Perceuse à métal
I Trapano
E Taladro eléctrico
CN 电钻



YATO	W	
YT-82050	550	5

L_{pa} = 92,0 ± 3,0 dB;
L_{wa} = 103,0 ± 3,0 dB;
a_v = 4,31 ± 1,5 m/s²

GB Electric drill
D Elektrobohrmaschine
PL Wiertarka elektryczna
RUS Электрическая дрель
CZ Elektrická vrtačka
H Elektromos fúrógép
RO Mașină de găurit electrică
F Perceuse à métal
I Trapano
E Taladro eléctrico
CN 电钻



YATO	W	
YT-82051	580	5

L_{pa} = 92,0 ± 3,0 dB;
L_{wa} = 103,0 ± 3,0 dB;
a_v = 4,31 ± 1,5 m/s²

GB Drywall screwdriver
D Trockenbauschrauber
PL Wkrętarka elektryczna
RUS Сетевой шуруповерт
CZ Sádokartonářský šroubovák
H Gipszkarton csavarzó
RO Șurubelniță pt. gips-carton
F Perceuse aux plaques de plâtre
I Trapano
E Atomilladores para construcción en seco
CN 墙板螺丝刀



YATO	W	
YT-82070	500	5

L_{pa} = 86 ± 3 dB;
L_{wa} = 97 ± 3 dB;
a_v = 2,32 ± 1,5 m/s²

GB Diamond drill
D Diamantbohrmaschine
PL Wiertnica diamentowa
RUS Дрель алмазного сверления
CZ Diamantová vrtačka
H Gyémántfúrógép
RO Mașină de găurit cu diamant
F Appareil de forage diamant
I Perforatrice diamantata
E Taladradora de diamante
CN 墙水钻



YATO	W	
YT-81980	2200	1

L_{pa} = 90,0 ± 3,0 dB;
L_{wa} = 103,0 ± 3,0 dB;
a_v = 2,90 ± 1,5 m/s²

GB Rotary hammer
 D Bohrhämmer
 PL Motowiertarka SDS-plus
 RUS Перфоратор
 CZ Vrtací kladivo
 H Fúrókalapács
 RO Ciocan rotopercutor
 F Marteau perforateur
 I Martello rotativo
 E Martillo perforador
 CN 电锤

220-240V~50Hz	620 W	0-870 rpm	0-4850 mm/s	2.3 J IMPACT ENERGY (ENERGIA UDARU)		



L_{pa} = 91,2 ± 3 dB;
 L_{wa} = 102,2 ± 3 dB;
 a_s = 14,054 ± 1,5 / 11,744 ± 1,5 m/s²



YATO	W	
YT-82115	620	3

GB Rotary hammer
 D Bohrhämmer
 PL Motowiertarka SDS-plus
 RUS Перфоратор
 CZ Vrtací kladivo
 H Fúrókalapács
 RO Ciocan rotopercutor
 F Marteau perforateur
 I Martello rotativo
 E Martillo perforador
 CN 电锤

230V~50Hz	850 W	0-1100 rpm	0-4900 mm/s			



L_{pa} = 91,8 ± 3 dB;
 L_{wa} = 102,8 ± 3 dB;
 a_s = 15,810 ± 1,5 / 14,092 ± 1,5 m/s²



YATO	W	
YT-82120	850	4

GB Rotary hammer
 D Bohrhämmer
 PL Motowiertarka SDS-plus
 RUS Перфоратор
 CZ Vrtací kladivo
 H Fúrókalapács
 RO Ciocan rotopercutor
 F Marteau perforateur
 I Martello rotativo
 E Martillo perforador
 CN 电锤

220-240V~50Hz	850 W	0-1300 rpm	0-5100 mm/s	3.3 J IMPACT ENERGY (ENERGIA UDARU)		



L_{pa} = 92,3 ± 3 dB;
 L_{wa} = 103,3 ± 3 dB;
 a_s = 11,964 ± 1,5 / 10,037 ± 1,5 m/s²

YATO	W	
YT-82122	850	3

GB Rotary hammer
 D Bohrhämmer
 PL Motowiertarka SDS-plus
 RUS Перфоратор
 CZ Vrtací kladivo
 H Fúrókalapács
 RO Ciocan rotopercutor
 F Marteau perforateur
 I Martello rotativo
 E Martillo perforador
 CN 电锤

230V~50Hz	1100 W	0-850 rpm	5000 mm/s			



L_{pa} = 95 ± 3 dB;
 L_{wa} = 106 ± 3 dB;
 a_s = 14,65 ± 1,5 / 12,77 ± 1,5 m/s²

YATO	W	
YT-82123	1100	2

GB Rotary hammer
 D Bohrhämmer
 PL Motowiertarka SDS-plus
 RUS Перфоратор
 CZ Vrtací kladivo

H Fúrókalapács
 RO Ciocan rotopercutor
 F Marteau perforateur
 I Martello rotativo
 E Martillo perforador
 CN 电锤

230V~50Hz	1250 W	800 rpm	3900 mm/s		4 J IMPACT ENERGY (ENERGIA UDARU)	



L_{pa} = 86,25 ± 3 / 92,4 ± 3 dB;
 L_{wa} = 97,25 ± 3 / 103,4 ± 3 dB;
 a_s = 15,105 ± 1,5 / 14,641 ± 1,5 m/s²

YATO	W	
YT-82125	1250	2

GB Rotary hammer
 D Bohrhämmer
 PL Motowiertarka SDS-plus
 RUS Перфоратор
 CZ Vrtací kladivo

H Fúrókalapács
 RO Ciocan rotopercutor
 F Marteau perforateur
 I Martello rotativo
 E Martillo perforador
 CN 电锤

230V~50Hz	1500 W	800 rpm	3900 mm/s		5 J IMPACT ENERGY (ENERGIA UDARU)	



L_{pa} = 94,6 ± 3 dB;
 L_{wa} = 105,6 ± 3 dB;
 a_s = 19,167 ± 1,5 / 13,314 ± 1,5 m/s²

YATO	W	
YT-82127	1500	2

GB Rotary hammer
D Bohrhammer
PL Młotowiertarka
SDS-plus
RUS Перфоратор
CZ Vrtací kladivo

H Fűrőkalapács
RO Ciocan rotopercutor
F Marteau perforateur
I Martello rotativo
E Martillo perforador
CN 电锤



$L_{pa} = 93,8 \pm 3 / 95,8 \pm 3$ dB;
 $L_{wa} = 104,8 \pm 3 / 106,8 \pm 3$ dB;
 $a_s = 14,89 \pm 1,5 / 13,02 \pm 1,5$ m/s²

YATO	W	
YT-82130	1050	2

GB Rotary hammer
D Bohrhammer
PL Młotowiertarka SDS-plus
RUS Перфоратор
CZ Vrtací kladivo
H Fűrőkalapács
RO Ciocan rotopercutor
F Marteau perforateur
I Martello rotativo
E Martillo perforador
CN 电锤



$L_{pa} = 96,1 \pm 3,0$ dB;
 $L_{wa} = 107,1 \pm 3,0$ dB;
 $a_s = 22,31 \pm 1,5 / 20,91 \pm 1,5$ m/s²

YATO	W	
YT-82135	1600	1

GB Chiselling hammer
D Schlaghammer
PL Młot dłutujący
RUS Отбойный молоток
CZ Sekací kladivo
H Vésőkalapács

RO Ciocan demolitor
F Marteau-piqueur
I Martello demolitore
E Martillo de percusión
CN 电镐



$L_{pa} = 83,5 \pm 3,0$ dB;
 $L_{wa} = 97,5 \pm 2,4$ dB;
 $a_s = 15,546 \pm 1,5$ m/s²

YATO	W	
YT-82133	1150	2

GB Demolition hammer
D Abbruchhammer
PL Młot wyburzeniowy
RUS Отбойный молоток
CZ Bourací kladivo
H Bontókalapács
RO Ciocan demolitor
F Brise-béton
I Martello demolitore
E Martillo de demolición
CN 电镐

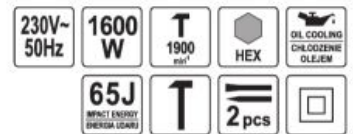

• switch lock for continuous operation
• blokada włącznika do pracy ciągłej

YATO	W	
YT-82001	1600	1

GB Concrete vibrator set
D Tragbarer BiegeWellenrüttler
PL Wibrator do betonu
(napęd + buława)
RUS Вибратор для бетона
CZ Ponořný vibrátor
H Betonvibrátor szett

RO Vibrator de adancime pt. beton
F Vibreur à béton
I Vibratore per il calcestruzzo
E Vibrador de hormigón
eléctrico
CN 混凝土振动器



$L_{pa} < 70$ dB;
 $L_{wa} < 85$ dB;
 $a_s < 2,5$ m/s²

YATO	W	
YT-82600	1200	5

GB Concrete vibrator set
D Tragbarer BiegeWellenrüttler
PL Wibrator do betonu
(napęd + buława)
RUS Вибратор для бетона
CZ Ponořný vibrátor
H Betonvibrátor szett

RO Vibrator de adancime pt. beton
F Vibreur à béton
I Vibratore per il calcestruzzo
E Vibrador de hormigón
eléctrico
CN 混凝土振动器



$L_{pa} < 70$ dB;
 $L_{wa} < 85$ dB;
 $a_s < 2,5$ m/s²

YATO	W	
YT-82601	2300	2

GB Circular saw
D Handkreissäge
PL Piłarka elektryczna
RUS Дисковая пила
CZ Ručna kružna pila
H Kézi körfűrész
RO Ferăstrău circular de mana

F Tronçonneuse
I Sega circolare
E Sierra circular
CN 电圆锯

230V~50Hz
1300 W
5500 rpm
Ø (mm) 190x25 x3,0 (mm) *torcida*
90°-65 mm
45°-48 mm



L_{pa} = 98,64 ± 3,0 dB;
L_{wa} = 111,64 ± 3,0 dB;
a₁ = 1,189 ± 1,5 / 1,180 ± 1,5 m/s²

YATO	W	
YT-82150	1300	2

GB Circular saw
D Handkreissäge
PL Piłarka elektryczna
RUS Дисковая пила
CZ Ručna kružna pila
H Kézi körfűrész

RO Ferăstrău circular de mana
F Tronçonneuse
I Sega circolare
E Sierra circular
CN 电圆锯

230V~50Hz
2000 W
4500 rpm
Ø (mm) 230x25,4 x3,0 (mm) *torcida*
83 mm
90°-83 mm
45°-62 mm



L_{pa} = 98,64 ± 3,0 dB;
L_{wa} = 111,64 ± 3,0 dB;
a₁ = 1,868 ± 1,5 / 2,513 ± 1,5 m/s²

YATO	W	
YT-82153	2000	2

GB Miter saw
D Paneelsäge
PL Ukośnica
RUS Панельная пила
CZ Pokosová pila se zákluzem
H Sines gérvágó
RO Ferăstrău circular staționar

F Scie à onglet radiale
I Segga angolare taglio leghe
E Ingletdora telescopica
CN 斜切锯

230V~50Hz
1800 W
4800 rpm
Ø (mm) 255x30x2,8
60T



L_{pa} = 86,0 ± 3,0 dB;
L_{wa} = 99,0 ± 3,0 dB;
a₁ = 1,297 ± 1,5 m/s²

YATO	W	
YT-82171	1800	1

GB Jig saw
D Stichsäge
PL Wyrzynarka
RUS Электрический лобзик
CZ Přímočará pila

H Szűrőfűrész
RO Ferăstrău pt. traforaj
F Scie sauteuse
I Seghetto alternativo
E Sierra de calar
CN 曲线锯

230V~50Hz
550 W
800-2600 rpm
65 mm
QUICK REPLACEMENT
SZYBKĄ WYMIANĄ



L_{pa} = 80,9 ± 3,0 dB;
L_{wa} = 91,9 ± 3,0 dB;
a₁ = 13,2 ± 1,5 / 13,8 ± 1,5 m/s²

YATO	W	
YT-82270	550	5

GB Jig saw
D Stichsäge
PL Wyrzynarka
RUS Электрический лобзик
CZ Přímočará pila
H Szűrőfűrész

RO Ferăstrău pt. traforaj
F Scie sauteuse
I Seghetto alternativo
E Sierra de calar
CN 曲线锯

230V~50Hz
750 W
800-2800 rpm
110 mm
10 mm
45°



L_{pa} = 80,9 ± 3,0 dB;
L_{wa} = 91,9 ± 3,0 dB;
a₁ = 13,2 ± 1,5 / 13,8 ± 1,5 m/s²

YATO	W	
YT-82272	750	5

GB Electric planer
D Elektroholer
PL Strug elektryczny
RUS Электрорубанок
CZ Elektrický hoblík
H Elektromos gyalu

RO Rindea electrica
F Rabot
I Pialla elettrica
E Garlopa electrica
CN 电刨

230V~50Hz
810 W
16500 rpm
0-3 mm
11 mm (mm)
82 mm



L_{pa} = 87,0 ± 3,0 dB;
L_{wa} = 98,0 ± 3,0 dB;
a₁ = 7,68 ± 1,5 m/s²

YATO	W	
YT-82141	810	6

GB Electric planer
D Elektroholer
PL Strug elektryczny
RUS Электрорубанок
CZ Elektrický hoblík
H Elektromos gyalu

RO Rindea electrica
F Rabot
I Piatta elettrica
E Garlopa electrica
CN 电刨



$L_{pA} = 92,0 \pm 3,0$ dB;
 $L_{wA} = 103,0 \pm 3,0$ dB;
 $a_s = 4,31 \pm 1,5$ m/s²

YATO	W	
YT-82140	1050	4

GB Sabre saw
D Stichsäge
PL Pila szablasta
RUS Сабельная пила

CZ Šavlová pila
H Szablyafűrész
RO Ferăstrău electric
F Scie sabre

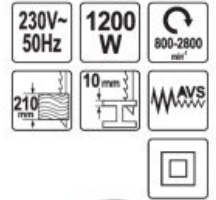

$L_{pA} = 83,9 \pm 3,0$ dB;
 $L_{wA} = 94,9 \pm 3,0$ dB;
 $a_s = 15,2 \pm 1,5$ m/s²

YATO	W	
YT-82280	1200	4

GB Finishing sander
D Schwingschleifer
PL Szlifierka oscylacyjna
CZ Oscilační bruska
H Vibrációs csiszológép
RO Polizor oscilant
F Ponceuse vibrante
I Levigatrice orbitali
E Lijadora de oscilación
CN 砂光机



$L_{pA} = 82,0 \pm 3,0$ dB;
 $L_{wA} = 93,0 \pm 3,0$ dB;
 $a_s = 5,4 \pm 1,5$ m/s²

YATO	W	
YT-82230	260	4

GB Drywall sander
D Wandschleifer
PL Szlifierka do tynków
RUS Шлифмашина
CZ Brúska muriva
H Kézi csiszoló fal
RO De perete manual slefuitor

F Ponceuse a platre filaire
I Levigatrice per intonaco
E Lijadora virutex pared manual
CN 干墙打磨机



$L_{pA} = 97,0 \pm 3,0$ dB;
 $L_{wA} = 108,0 \pm 3,0$ dB;
 $a_s = 8,96 \pm 1,5 / 13,04 \pm 1,5$ m/s²



- 2 functions:
- concrete grinding
- plaster sanding
- 2 funkcje:
- szlifowanie betonu
- szlifowanie gipsu

YATO	W	
YT-82341	1300	2

GB Drywall sander
D Wandschleifer
PL Szlifierka do tynków
RUS Шлифмашина
CZ Brúska muriva
H Kézi csiszoló fal
RO De perete manual slefuitor

F Ponceuse a platre filaire
I Levigatrice per intonaco
E Lijadora virutex pared manual
CN 干墙打磨机

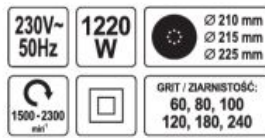

$L_{pA} = 85,0 \pm 3,0$ dB;
 $L_{wA} = 96,0 \pm 3,0$ dB;
 $a_s = 4,83 \pm 1,5$ m/s²

YATO	W	
YT-82340	1220	2

GB Drywall sander
D Wandschleifmaschine mit Ausleger
PL Szlifierka na wysięgniku do ścian
RUS Шлифовальная машина для стен
CZ Bruska na stěny s ramenem
H Hosszúszárú falcsiszoló
RO Polizor cu brat pt. pereti
F Ponceuse pour cloison sèche
I Levigatrice telescopica per muri
E Pulidor para paredes en un brazo
CN 干墙打磨机



$L_{pA} = 88,0 \pm 3,0$ dB;
 $L_{wA} = 99,0 \pm 3,0$ dB;
 $a_s = 3,48 \pm 1,5 / 3,51 \pm 1,5$ m/s²

YATO	W	
YT-82350	710	2

GB Electric spray gun
 D Elektro farbspritzpistole
 PL Elektryczny pistolet malarski
 RUS Электрический пульверизатор
 CZ Elektrická pistole malářská
 H Elektromos festékszoro pisztolye
 RO Pistol de vopisit - electric
 F Pistolet a peinture électrique
 I Pistola elettrica per verniciare
 E Pistola de pintar electric
 CN 电动喷枪

230V~50Hz
 500 W
 0.4 l/min
 1000 ml



YATO	W	
YT-82550	500	4

$L_{PA} = 102.0 \pm 3.0$ dB;
 $L_{WA} = 113.0 \pm 3.0$ dB;
 $a_w = 2.12 \pm 1.5$ m/s²

GB Airless paint sprayer
 D Farbsprüngerät
 PL Agregat malarski
 RUS Краскопульты
 CZ Stříkací zařízení
 H Festékszóró rendszer
 RO Pompa vopisit airless
 F Pistolet à peinture
 I Gruppo di verniciatura
 E Bomba de piston para spray de pintura airless
 CN 高压无气喷涂机

220-240V~50Hz
 650 W
 1.1 l/min
 207 Bar
 20.7 MPa
 AIRLESS
 250-310 mm
 7.5m



$L_{PA} = 93.3 \pm 3.0$ dB;
 $L_{WA} = 104.3 \pm 3.0$ dB;
 $a_w = \leq 2.5$ m/s²

YATO	W	
YT-82560	650	1

• for interior paints
 • do farb ściennych

GB Multi-purpose oscillating tool
 D Multifunktionales Oszillationswerkzeug
 PL Wielofunkcyjne narzędzie oscylacyjne
 RUS Многофункциональный инструмент
 CZ Multifunkční oscilační nářadí
 H Multifunkciós rezgő szerszám
 RO Unealtă multifuncțională oscilantă
 F Outil multifonctions oscillant
 I Oscillante strumento multifunzione
 E Herramienta oscilatoria multiusos
 CN 多功能啊雄莓



10.8 V
 Li-Ion
 5000-15000 rpm
 1h
 QUICK CHANGES SYSTEM
 QUICK RELEASE SYSTEM



additional battery in set
 dodatkowy akumulator
 w zestawie

$L_{PA} = 78.20 \pm 3.0$ dB;
 $L_{WA} = 89.20 \pm 3.0$ dB;
 $a_w = 1.609 \pm 1.5 / 2.503 \pm 1.5$ m/s²

YATO	V	
YT-82900	10.8	5

GB Multi-purpose oscillating tool
 D Multifunktionales Oszillationswerkzeug
 PL Wielofunkcyjne narzędzie oscylacyjne
 RUS Многофункциональный инструмент
 CZ Multifunkční oscilační nářadí
 H Multifunkciós rezgő szerszám
 RO Unealtă multifuncțională oscilantă
 F Outil multifonctions oscillant
 I Oscillante strumento multifunzione
 E Herramienta oscilatoria multiusos
 CN 多功能啊雄莓

GB Oscillante strumento multifunzione
 E Herramienta oscilatoria multiusos
 CN 多功能啊雄莓

230V~50Hz
 300 W
 15000-22000 rpm

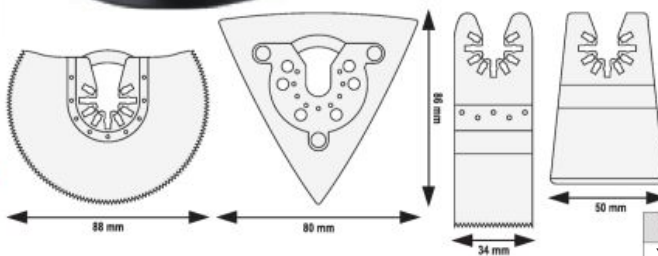
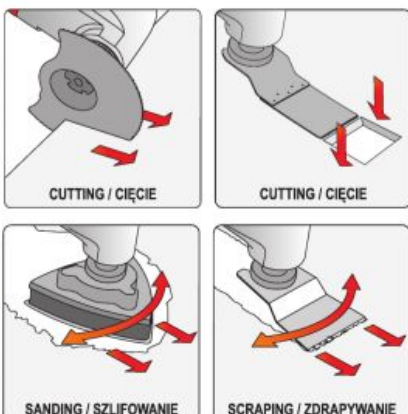

BMC & COLOR SLEEVE

$L_{PA} = 86.2 \pm 3$ dB;
 $L_{WA} = 97.2 \pm 3$ dB;
 $a_w = 3.772 \pm 1.5$ m/s²

YATO	W	
YT-82220	300	4

GB Multi-purpose oscillating tool
D Multifunktionales Oszillationswerkzeug
PL Wielofunkcyjne narzędzie oscylacyjne
RUS Многофункциональный инструмент
CZ Multifunkční oscilační nářadí
H Multifunkciós rezgő szerszám
RO Unealtă multifuncțională oscilantă
F Outil multifonctions oscillant

I Oscillante strumento multifunzione
E Herramienta oscilatoria multiusos
CN 多功能啊雄莓

230-240V~50Hz
500 W
8000-16000 rpm

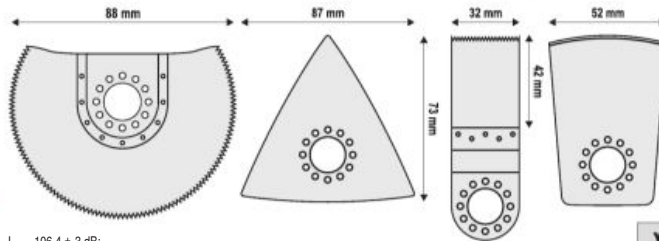

$L_{A1} = 106.4 \pm 3$ dB;
 $L_{A2} = 117.4 \pm 3$ dB;
 $a_e = 12.71 \pm 1.5$ m/s²

YATO	W	
YT-82223	500	5



GB Industrial vacuum cleaner
D Industriesauger
PL Odkurzacz przemysłowy
RUS Пилосос промышленный
CZ Průmyslový vysavač
H Ipari porszívó
RO Aspirator industrial
F Aspirateur eau et poussières
I Aspirapolvere industriale
E Aspirador industrial
CN 三合一多功能吸尘器

220-240V~50/60Hz
1400 W
20 l
18 kPa
IPX4
WET AND DRY SUCHO MOKRO
max. 2000 W
POWER SOCKET GNIAZDO ZASILAJĄCE

GB Industrial vacuum cleaner
D Industriesauger
PL Odkurzacz przemysłowy
RUS Пилосос промышленный
CZ Průmyslový vysavač
H Ipari porszívó
RO Aspirator industrial
F Aspirateur eau et poussières
I Aspirapolvere industriale
E Aspirador industrial
CN 三合一多功能吸尘器

220-240V~50/60Hz
1400 W
30 l
18 kPa
IPX4
WET AND DRY SUCHO MOKRO
max. 2000 W
POWER SOCKET GNIAZDO ZASILAJĄCE



COLOR BOX



YATO	W	
YT-85700	1400	1



COLOR BOX



YATO	W	
YT-85701	1400	1

GB Industrial vacuum cleaner
 D Industriesauger
 PL Odkurzacz przemysłowy
 RUS Пилосос промышленный
 CZ Průmyslový vysavač
 H Ipari porszívó
 RO Aspirator industrial
 F Aspirateur eau et poussières
 I Aspirapolvere industriale
 E Aspirador industrial
 CN 三合一多功能吸尘器

220-240V~50/60Hz
2400 W
70 l
18 kPa
 WET AND DRY SUCHO MOKRO
 ADJUSTABLE POWER REGULACJA MOCY
IPX4



COLOR BOX

YATO	W	
YT-85710	2400	1

GB Industrial vacuum cleaner
 D Industriesauger
 PL Odkurzacz przemysłowy
 RUS Пилосос промышленный
 CZ Průmyslový vysavač
 H Ipari porszívó
 RO Aspirator industrial
 F Aspirateur eau et poussières
 I Aspirapolvere industriale
 E Aspirador industrial
 CN 三合一多功能吸尘器

220-240V~50/60Hz
1600 W
30 l
18 kPa
 WET AND DRY SUCHO MOKRO
 BLOW FUNCTION FUNKCJA DMUCHAWY
 POWER SOCKET GNIAZDO ZASILAJĄCE
IPX4

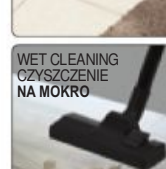

COLOR BOX

YATO	W	
YT-85715	1600	1

GB Thermal knife for polystyrene foam
 D Thermomesser für Styropor
 PL Nóż termiczny do styropianu
 RUS Термонож для пенопласта
 CZ Termický nůž na pěnový polystyrén
 H Polisztirol vágó hőkés

RO Cuțit termic pt. stiropian
 F Couteau thermique à styrofoam
 I Coltello termico per polistirolo

E Cuchilla térmica para poliestireno
 CN 热切割刀

230V~50Hz
220 W
70-450 °C
 POLYSTYRENE STYROPIAN
 PVC
 LED



COLOR BOX

YATO	W	L (mm)	
YT-82190	220	220	10

GB Hot air gun
 D Heissluftpistole
 PL Opalarka
 RUS Фен для обжигания краски
 CZ Opalovací stroj

H Hőlégfúvó
 RO Fion pt. ars vopseaua
 F Décapeur thermique
 I Generatore aria calda
 E Secadora
 CN 热风枪

230V~50Hz
2000 W
550°C
500 l/min



COLOR BOX

YATO	W	
YT-82288	2000	10

GB Hot air gun with accessories
 D Heissluftpistole
 PL Opalarka z akcesoriami
 RUS Фен для обжигания краски в наборе
 CZ Opalovací stroj s příslušenstvím
 H Hőlégfúvó tartozékokkal

RO Fion cu accesorii pt. ars vopseaua
 F Décapeur thermique
 I Generatore aria calda con accessori
 E Secadora con accesorios
 CN 热风枪

230V~50Hz
2000 W
550°C
500 l/min



BMC & COLOR SLEEVE

YATO	W	
YT-82291	2000	5

GB Hot air gun with accessories
D Heissluftpistole
PL Opalarka z akcesoriami
RUS Фен для обжигания краски в наборе
CZ Opalovací stroj s příslušenstvím
H Hőlégtűvő tartozékokkal
RO Fion cu accesorii pt. ars vopseaua
F Décapeur thermique
I Generatore aria calda con accessori
E Secadora con accesorios
CN 热风枪

230V~50Hz 2000 W
550°C 500 l/min
LED
TEMPERATURE ADJUSTMENT
REGULACJA TEMPERATURY



BMC & COLOR SLEEVE

YATO	W	
YT-82292	2000	5

GB Hot air gun with accessories
D Heissluftpistole
PL Opalarka z akcesoriami
RUS Фен для обжигания краски в наборе
CZ Opalovací stroj s příslušenstvím
H Hőlégtűvő tartozékokkal
RO Fion cu accesorii pt. ars vopseaua
F Décapeur thermique
I Generatore aria calda con accessori
E Secadora con accesorios
CN 热风枪

230V~50Hz 2000 W
600°C 500 l/min
LCD DISPLAY WITH 4 DIGIT
TEMPERATURE ADJUSTMENT
REGULACJA TEMPERATURY



BMC & COLOR SLEEVE

YATO	W	
YT-82293	2000	5

GB Blower
D Gebläse
PL Dmuchawa
RUS Сетевой вентилятор
CZ Výtačný ventilátor
H Légtűvő
RO Suflantă
F Souffleur
I Soffiatore
E Soplador
CN 吹吸机

220-240V-50/60Hz 600 W 6000-16000 rpm
4 m³/min
2m
SUCTION FUNCTION FUNKCJA ZASYSANIA
BLOW FUNCTION FUNKCJA DMUCHAWY



COLOR BOX

L_{WA} = 82.1 ± 2.5 dB;
L_{WA} = 95.0 ± 2.5 dB;
a_{WA} = 2.994 ± 1.5 m/s²

YATO	W	
YT-85170	600	4

GB Gas torch
D Gasbrenner
PL Palnik gazowy
RUS Газовая паяльная лампа
CZ Plynový hořák
H Gázégő
RO Arzător de gaz
F Brûleur à gaz
I Saldatore bruciatore a gas
E Soplete de gas
CN 火焰枪

PIEZO 30 ml 60-90 min
GAS GAZ
LOCK BLOKADA
BUTANE lighter gas BUTAN gas de aprindere
CHILD PROTECTION ZABRANECIENIE PRIZED DOBEHAN



DOUBLE BLISTER

YATO	W	
YT-36700	30-125	10/20

GB Soldering tool set
D Gaslötkolben satz
PL Lutownica gazowa z akcesoriami
RUS Газовый паяльный набор
CZ Plynova pajka souprava
H Gaz forrasztópaka készletek
RO Set ciocan de lipit cu gaz
F Fer à souder à gaz
I Saldatore a gas
E Soldador a gas con accesorios
CN 自动点火多功能瓦斯组套

SOLDERING IRON
LUTOWNICA 450°C

HOT AIR GUN
OPALARKA 600°C

TORCH
PALNIK 1300°C

7 PCS 30-125 W 30 ml 75 min
GAS GAZ
PIEZO
LOCK BLOKADA
BUTANE lighter gas BUTAN gas de aprindere



PREPARE-BUTANE lighter gas PROPAN-BUTAN gas de aprindere
CHILD PROTECTION ZABRANECIENIE PRIZED DOBEHAN

GAS LEVEL INSPECTION WINDOW
KONTROLA POZIOMU GAZU

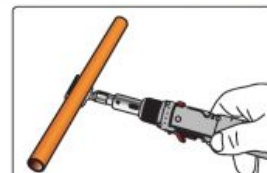

PLASTIC BOX & HANGING COLOR BOX

YATO	W	
YT-36706	30-125	6

- GB Soldering tool 3 in 1
- D Gaslötkolben 3 in 1
- PL Lutownica gazowa 3 w 1
- RUS Газовый паяльник 3-в-1
- CZ Plynová pájka 3 in 1
- H Gaz-forrasztópaka 3 in 1
- RO Ciocan de lipit cu gaz 3 in 1
- F Fer à souder à gaz
- I Saldatore a gas
- E Soldador de gas 3 in 1
- CN 瓦斯焊接工具



PIEZO	30-70 W	12 ml	60 min	GAS GAZ
LOCK BLOKADA	BUTANE lighter gas BUTAN (gas de incendiar)	PROPANE-BUTANE lighter gas PROPAN-BUTAN (gas de incendiar)	CHILD PROTECTION (PAREZ SPECIFICNE PRED DOKAZ)	

SOLDERING IRON LUTOWNICA 350°C	HOT AIR GUN OPALARKA 550°C	TORCH PALNIK 1300°C	GAS LEVEL INSPECTION WINDOW KONTROLA POZIOMU GAZU
--	--------------------------------------	-------------------------------	--

YATO	W	
YT-36704	30-70	12/72

SLIDING CARD



- GB Gas blow torch
- D Lötbrenner
- PL Palnik gazowy
- RUS Газовая горелка
- CZ Plynový hořák
- H Gázégő
- RO Arzător de gaz
- F Bruleur à gaz
- I Saldatore bruciatore a gas
- E Soplete de gas
- CN 火焰枪

1000°C	360°
EURO TYPE EN417	



PIEZO	1.0 kW	73 g/h	GAS GAZ	BUTANE BUTAN
-------	--------	--------	---------	--------------

YATO	kW	
YT-36710	1.0	10/100

SLIDING CARD



- GB Gas blow torch
- D Lötbrenner
- PL Palnik gazowy
- RUS Газовая горелка
- CZ Plynový hořák
- H Gázégő
- RO Arzător de gaz
- F Bruleur à gaz
- I Saldatore bruciatore a gas
- E Soplete de gas
- CN 火焰枪

1600°C	360°
EURO TYPE EN417	



PIEZO	1.28 kW	GAS GAZ	AIR POWETRZE	LOCK BLOKADA	BUTANE BUTAN
-------	---------	---------	--------------	--------------	--------------

YATO	kW	
YT-36709	1.28	6/12

SLIDING CARD



- GB Turbo gas torch
- D Turbo-Handbrenner
- PL Palnik gazowy turbo
- RUS Газовая горелка турбо
- CZ Plynový hořák turbo
- H Kézi gázégő
- RO Arzător cu gaz turbo
- F Bruleur à gaz
- I Saldatore bruciatore a gas
- E Quemador de gas turbo
- CN 手持式焊枪

360°	ADAPTER G1" M x G7/16" F	EURO TYPE EN417
------	-----------------------------	-----------------



PIEZO	2800°C	2.0 kW	142 g/h	2.59 MPa	G1" F	PROPAN
GAS GAZ	AUTO START STOP	LOCK BLOKADA	CONTINUOUS RUN LOCK BLOKADA PRACY CIĄGŁEJ	TURBO NOZZLE DYSSZA TURBO		

YATO	kW	
YT-36715	2.0	20

DOUBLE BLISTER



- GB Soldering iron
- D Lötkolben
- PL Lutownica oporowa
- RUS Электропаяльник
- CZ Pájka odporová
- H Forrasztópaka
- RO Ciocan de lipit
- F Fer à souder
- I Saldatore a stagno
- E Soldador de resistencia
- CN 电烙铁



HANGING DISPLAY COLOR BOX

230V-50Hz	400-520 °C	2-3 min
-----------	------------	---------

YATO	W	max. temperature of soldering tip / max. temperatura grotu (°C)	dimensions of soldering tip / wymiary grotu (mm)	
YT-8271	30	400	ø3.8 x 70	16
YT-8272	60	500	ø6.0 x 78	16
YT-8273	80	520	ø6.8 x 64	16

GB Transformer soldering gun
D Lötspistole
PL Lutownica transformatorowa
RUS Паяльник электрический
CZ Transformátorová páječka
H Forrasztópáka
RO Aparat de lipid letcon
cu transformator

F Fer à souder
I Saldatore
istantaneo
E Soldador
transformador
CN 电烙铁

230V~
50Hz 180
W WORKING MODE
TRYB PRACY
S2 20% 0-600
°C LED



WORK LIGHT
OŚWIELENIE
PRACY

YATO	W	temp. (°C)	
YT-8245	180	0-600	10

GB Transformer soldering gun
D Lötspistole
PL Lutownica transformatorowa
RUS Паяльник электрический
CZ Transformátorová páječka
H Forrasztópáka
RO Aparat de lipid letcon
cu transformator
F Fer à souder

I Saldatore
istantaneo
E Soldador
transformador
CN 电烙铁

230V~
50Hz 200
W LED WORKING MODE
TRYB PRACY
S2 20% 351-500°C
201-350°C
10-200°C



WORK LIGHT
OŚWIELENIE
PRACY

YATO	W	temp. (°C)	
YT-82451	200	70-500	10

GB Soldering station
D Lötstation
PL Stacja lutownicza
RUS Паяльная станция
CZ Letovací stanice
H Forrasztópáka állomás
RO Stație de lipit

F Station de soudage
I Stazione digitale
di saldatura
E Estación
de soldadura
CN 数显焊台

230V~
50Hz 48W 150-450
°C 7.1 mm
65 mm LCD
DISPLAY
WYWIETLACZ



YATO	W	temp. (°C)	
YT-82455	48	150-450	4

GB Electric glue gun
D Heissklebepistole
PL Pistolet do klejenia
RUS Пистолет для клея
CZ Pistolet na lepení
H Ragasztópisztoly

RO Pistol pt. lipit
F Pistolet à colle
I Pistola colla
E Pistola de cola
CN 热胶枪

230V~
50Hz 35
(400)
W 150-200
°C 15
g/min 3-6
min 11 mm



YATO	W	diameter of glue stick średnica wkładu (mm)	capacity wydajność (g/min)	
YT-82401	35 (400)	11	15	12/24

GB Electric glue gun
D Heissklebepistole
PL Pistolet do klejenia
RUS Пистолет для клея
CZ Pistolet na lepení
H Ragasztópisztoly

RO Pistol pt. lipit
F Pistolet à colle
I Pistola colla
E Pistola de cola
CN 热胶枪

230V~
50Hz 20
(80)
W 180-200
°C 15
g/min 3-5
min 3x
∅11mm



YATO	W	diameter of glue stick średnica wkładu (mm)	capacity wydajność (g/min)	
YT-82402	20 (80)	11	15	12/48

GB PVC plastic pipe welder
D Schweißgerät für thermoplastische Rohre
PL Zgrzewarka do rur termoplastycznych
RUS Сварочная машина для термопластиковых труба
CZ Svářečka na termoplastické trubky
H Hegesztő berendezés termoplasztikus csövekhez
RO Masina de sudat tevi termoplastic
F Soudeur en tuyauterie en PVC
I Polifusore saldatore per tubi
E Máquina de soldar las tubos termoplasticos
CN 热熔器

230V~
50Hz 850
W 0-300°C
∅ 16, 20, 25, 32
[mm] 40, 50, 63



YATO	W	
YT-82250	850	2

GB Gasoline generator
D Stromgenerator
PL Generator prądowórczy
RUS Генератор тока
CZ Generátor vytvářející proud
H Áramfejlesztő generátorhoz
RO Generator de curent
F Groupe électrogène
I Generatore di corrente
E Generator de corriente
CN 逆变发电机

2500 W max
230V-50Hz
2x
196 cm³
Pb
3.6 l
0.6 l
AVR



L_{pa} = 72,7 ± 2,03 dB;
L_{wa} = 92,2 ± 2,03 dB

PLYWOOD BOX & COLOR LABEL

YATO
YT-85451 1

GB Gasoline generator
D Stromgenerator
PL Generator prądowórczy
RUS Генератор тока
CZ Generátor vytvářející proud
H Áramfejlesztő generátorhoz
RO Generator de curent
F Groupe électrogène
I Generatore di corrente
E Generator de corriente
CN 逆变发电机

2700 W max
230V-50Hz
2x
196 cm³
Pb
3.6 l
0.6 l
AVR



L_{pa} = 73,6 ± 2,00 dB;
L_{wa} = 93,2 ± 2,00 dB

PLYWOOD BOX & COLOR LABEL

YATO
YT-85453 1

GB Gasoline generator
D Stromgenerator
PL Generator prądowórczy
RUS Генератор тока
CZ Generátor vytvářející proud
H Áramfejlesztő generátorhoz
RO Generator de curent
F Groupe électrogène
I Generatore di corrente
E Generator de corriente
CN 逆变发电机

5500 W max
230V-50Hz
3x
380V 1x
389 cm³
Pb
25 l
1.1 l
AVR



L_{pa} = 75,0 ± 2,62 dB;
L_{wa} = 93,7 ± 2,62 dB

PLYWOOD BOX & COLOR LABEL

YATO
YT-85460 1

GB Gasoline generator
D Stromgenerator
PL Generator prądowórczy
RUS Генератор тока
CZ Generátor vytvářející proud
H Áramfejlesztő generátorhoz
RO Generator de curent
F Groupe électrogène
I Generatore di corrente
E Generator de corriente
CN 逆变发电机



ULTRA LIGHT
8.5 kg

L_{pa} = 70,46 ± 0 dB;
L_{wa} = 90,46 ± 0 dB

WOODEN BOX & COLOR LABEL

YATO
YT-85481 1

GB Gasoline generator
D Stromgenerator
PL Generator prądowórczy
RUS Генератор тока
CZ Generátor vytvářející proud
H Áramfejlesztő generátorhoz
RO Generator de curent
F Groupe électrogène
I Generatore di corrente
E Generator de corriente
CN 逆变发电机



ULTRA LIGHT
21.5 kg

L_{pa} = 73,3 ± 1,96 dB;
L_{wa} = 93,0 ± 1,96 dB

WOODEN BOX & COLOR LABEL

YATO
YT-85482 1

GB Gasoline water pump
D Pumpe mit verbrennungsmotor
PL Pompa spalinowa
RUS Бензонасос
CZ Čerpadlo se spalovacím motorem
H Robbanómotoros szivattyú
RO Pompa cu motor cu ardere interna
F Pompe à eau
I Motopompa
E Bomba de combustion
CN 汽油抽水泵

3.6 kW
3600 rpm
196 cm³
50mm 2"
Q_{MAX} 500 l/min
Q_{MAX} 30m³/h
25m
8m
3.6 l



L_{pa} = 82,1 ± 3,0 dB;
L_{wa} = 95,4 ± 3,0 dB

BROWN CARTON BOX & COLOR LABEL

YATO
YT-85401 1

GB Gasoline water pump
D Pumpe mit verbrennungsmotor
PL Pompa spalinowa
RUS Бензонасос
CZ Čerpadlo se spalovacím motorem
H Robbanómotoros szivattyú
RO Pompa cu motor cu ardere interna
F Pompe à eau
I Motopompa
E Bomba de combustion
CN 汽油抽水泵

3.6 kW
3600 rpm
196 cm³
80mm 3"
Q_{MAX} 800 l/min
Q_{MAX} 50m³/h
20m
8m
3.6 l



L_{pa} = 81,9 ± 3,0 dB;
L_{wa} = 95,0 ± 3,0 dB

BROWN CARTON BOX & COLOR LABEL

YATO
YT-85402 1

GB Gasoline water pump
D Pumpe mit verbrennungsmotor
PL Pompa spalinowa
RUS Бензонасос
CZ Čerpadlo se spalovacím motorem
H Robbanómotoros szivattyú
RO Pompa cu motor cu ardere interna
F Pompe à eau
I Motopompa
E Bomba de combustion
CN 汽油抽水泵

4.0 kW
3600 rpm
208 cm³
100mm 4"
Q_{MAX} 1300 l/min
Q_{MAX} 78m³/h
20m
8m
3.6 l



L_{pa} = 81,9 ± 3,0 dB;
L_{wa} = 94,9 ± 3,0 dB

BROWN CARTON BOX & COLOR LABEL

YATO
YT-85403 1

- GB Cordless pole saw
- D Akku-Hochentaster
- PL Akumulatorowa okrzyszarka na wysięgniku
- RUS Аккумуляторный телескопический высотерез
- CZ Akumulatorová vyvrtvovací pila na vysięgniku
- H Akkumulátoros magassági ágnyeső
- RO Ferăstraie cu lanț cu telescopic
- F Elagueuse sur perche
- I Potatore a batteria
- E Sierra de pértiga telescópica
- CN 高枝锯



100-215 cm

18 V	3.0 Ah	8" / 20 cm
Li-Ion	AUTOMATIC CHAIN LUBRICATOR	AUTOMATIC BRAKE (SAFETY TRACKER)
TOOL-FREE ADJUSTMENT OF CHAIN TENSION	BULMAGAZINOWA WYPOSAŻENIE WYPOSAŻENIA	OIL TANK 0.6 l



$L_{PA} = 78.8 \pm 3.0$ dB;
 $L_{WA} = 90.7 \pm 2.36$ dB;
 $a_n = 2.68 \pm 1.5 / 4.84 \pm 1.5$ m/s²

YATO	V	
YT-85120	18	2

- GB Cordless telescopic pole saw
- D Akku-Teleskop-Hochentaster
- PL Akumulatorowa okrzyszarka na wysięgniku
- RUS Аккумуляторный телескопический высотерез
- CZ Akumulatorová teleskopická vyvrtvovací pila
- H Akkus magassági ágvágvó távcsőves
- RO Ferăstraie cu lanț cu telescopic cu acumulator
- F Elagueuse sur perche télescopique sans-fil
- I Decescupigliatore telescopico a batteria
- E Sierra de pértiga telescópica a batería
- CN 充电式高枝锯



$L_{PA} = 78.2 \pm 3.0$ dB;
 $L_{WA} = 91.2 \pm 2.36$ dB;
 $a_n = 2.109 \pm 1.5$ m/s²



200-280 cm

18 V	Li-Ion	2.0 Ah	1h
2500 min ⁻¹	8" / 20 cm	5 m/s	

YATO	V	
YT-82836	18	2

- GB Cordless telescopic pole saw (tool only)
- D Akku-Teleskop-Hochentaster (nur das Gerät)
- PL Akumulatorowa okrzyszarka na wysięgniku (tylko narzędzie)
- RUS Аккумуляторный телескопический высотерез (только инструмент)
- CZ Akumulatorová teleskopická vyvrtvovací pila (pouze nářadí)
- H Akkus magassági ágvágvó távcsőves (csak a szerszámot)
- RO Ferăstraie cu lanț cu telescopic cu acumulator (numai sculă)
- F Elagueuse sur perche télescopique sans-fil (outil seulement)
- I Decescupigliatore telescopico a batteria (solo utensile)
- E Sierra de pértiga telescópica a batería (herramienta solamente)
- CN 充电式高枝锯 (光机)

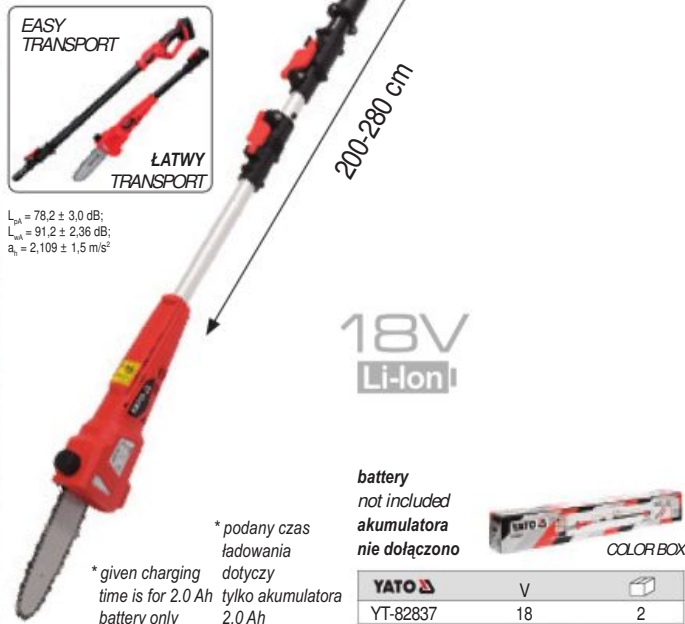

200-280 cm

18 V	Li-Ion	2500 min ⁻¹
1h*	8" / 20 cm	5 m/s

$L_{PA} = 78.2 \pm 3.0$ dB;
 $L_{WA} = 91.2 \pm 2.36$ dB;
 $a_n = 2.109 \pm 1.5$ m/s²

18V Li-Ion

battery not included
 akumulatora nie dołączono

* given charging time is for 2.0 Ah battery only
 * podany czas ładowania dotyczy tylko akumulatora 2.0 Ah

YATO	V	
YT-82837	18	2

- GB Cordless grass trimmer
- D Akku-Rasentrimmer
- PL Akumulatorowa podkaszarka do trawy
- RUS Аккумуляторный телескопический высотерез
- CZ Akumulatorová sekačka na trávu
- H Akkus szegélynyíró
- RO Trimmere de gazon cu acumulator
- F Coupe bordures sans fil
- I Tosaerba a filo a batteria
- E Desmalezadora inalámbrica
- CN 打草机



95-120 cm

$L_{PA} = 80.8 \pm 3.0$ dB;
 $L_{WA} = 88.5 \pm 2.64$ dB;
 $a_n = 4.41 \pm 1.5 / 3.33 \pm 1.5$ m/s²

18 V	3.0 Ah	8800 min ⁻¹
Li-Ion	250 mm	

YATO	V	
YT-85110	18	4

- GB Cordless grass trimmer
D Akku-Rasentrimmer
PL Akumulatorowa podkaszarka do trawy
RUS Аккумуляторный триммер
CZ Akumulátorová sekačka na trávu
H Akkus szegélynyíró
RO Trimmer de gazon cu acumulator
F Débroussailluse sans-fil
I Tagliabordi a batteria
E Desbrozadora a batería
CN 充电式打草机



$L_{pa} = 85,0 \pm 3,0$ dB;
 $L_{wa} = 93,0 \pm 3,0$ dB;
 $a_s = 2,5 \pm 1,5$ m/s²

YATO	V	
YT-82830	18	2

- GB Cordless grass trimmer (tool only)
D Akku-Rasentrimmer (nur das Gerät)
PL Akumulatorowa podkaszarka do trawy (tylko narzędzie)
RUS Аккумуляторный триммер (только инструмент)
CZ Akumulátorová sekačka na trávu (pouze nářadí)
H Akkus szegélynyíró (csak a szerszámot)
RO Trimmer de gazon cu acumulator (numai sculă)
F Débroussailluse sans-fil (outil seulement)
I Tagliabordi a batteria (solo utensile)
E Desbrozadora a batería (herramienta solamente)
CN 充电式打草机 (光机)



$L_{pa} = 85,0 \pm 3,0$ dB;
 $L_{wa} = 93,0 \pm 3,0$ dB;
 $a_s = 2,5 \pm 1,5$ m/s²

YATO	V	
YT-82831	18	2

battery not included
akumulatora nie dołączono

* given charging time
is for 2.0 Ah
battery only

* podany czas
ładowania dotyczy
tylko akumulatora
2.0 Ah

- GB Cordless hedge trimmer
D Akku-Heckenschere
PL Akumulatorowe nożyce do żywoplotu
RUS Аккумуляторный кусторез
CZ Akumulátorové nůžky na živé ploty
H Akkus sövénynyíró
RO Foarfece de tăiat gard viu cu acumulator
F Taille-haies sans fil

- I Tagliasiepi a batteria
E Cortasetos inalámbrico
CN 充电式修枝剪



$L_{pa} = 77,4 \pm 3,0$ dB;
 $L_{wa} = 86,5 \pm 2,07$ dB;
 $a_s = 1,96 \pm 1,5 / 2,07 \pm 1,5$ m/s²

YATO	V	
YT-85100	18	2

- GB Cordless hedge trimmer
D Akku-Heckenschere
PL Akumulatorowe nożyce do żywoplotu
RUS Аккумуляторный кусторез
CZ Akumulátorové nůžky na živé ploty
H Akkus sövénynyíró
RO Foarfece de tăiat gard viu cu acumulator
F Taille-haies sans fil

- I Tagliasiepi a batteria
E Cortasetos inalámbrico
CN 充电式修枝剪



$L_{pa} = 80,0 \pm 3,0$ dB;
 $L_{wa} = 87,0 \pm 3,0$ dB;
 $a_s = 3,5 \pm 1,5$ m/s²

YATO	V	
YT-82832	18	2

- GB Cordless hedge trimmer (tool only)
D Akku-Heckenschere (nur das Gerät)
PL Akumulatorowe nożyce do żywoplotu (tylko narzędzie)
RUS Аккумуляторный кусторез (только инструмент)
CZ Akumulátorové nůžky na živé ploty (pouze nářadí)
H Akkus sövénynyíró (csak a szerszámot)
RO Foarfece de tăiat gard viu cu acumulator (numai sculă)
F Taille-haies sans-fil (outil seulement)
I Tagliasiepi a batteria (solo utensile)
E Cortasetos inalámbrico (herramienta solamente)
CN 充电式高枝剪 (光机)

battery not included
akumulatora
nie dołączono



$L_{pa} = 80,0 \pm 3,0$ dB;
 $L_{wa} = 87,0 \pm 3,0$ dB;
 $a_s = 3,5 \pm 1,5$ m/s²

YATO	V	
YT-82833	18	2

* given charging time
is for 2.0 Ah
battery only

* podany czas
ładowania dotyczy
tylko akumulatora
2.0 Ah

GB Cordless hedge trimmer
 D Akku-Heckenschere
 PL Akumulatorowe nożyce do żywopłotu
 RUS Аккумуляторный кусторез
 CZ Akumulátorové nůžky na živé ploty
 H Akkus sövénynyíró
 RO Foarfece de tăiat gard viu cu acumulator
 F Taille-haies sans-fil
 I Tagliasiepi a batteria
 E Tijera cortasetos a batería
 CN 充电式高枝剪

18 V Li-Ion
 2.0 Ah
 1h QUICK CHARGING (2.0Ah)
 2100 min*
 420 mm



$L_{pA} = 77,3 \pm 3,0$ dB;
 $L_{pM} = 88,1 \pm 3,0$ dB;
 $a_n = 1,5 \pm 1,5$ m/s²

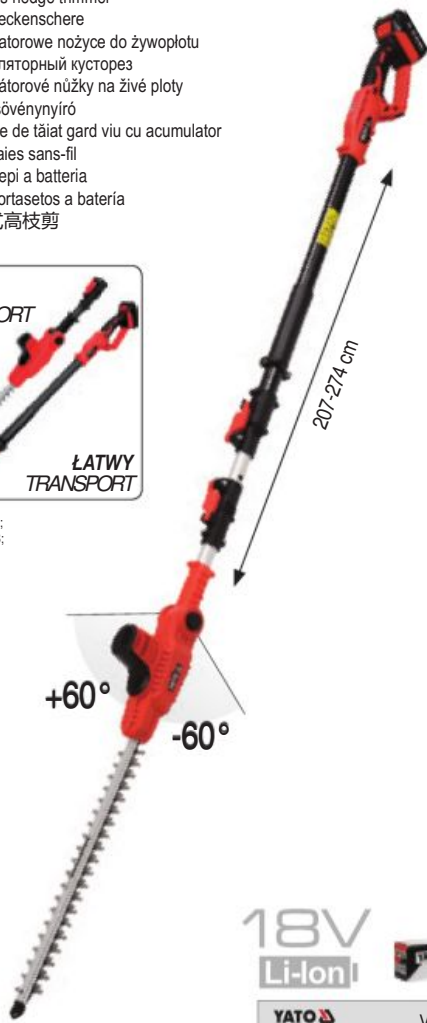

18V Li-Ion
 YATO V
 YT-82834 18 2
 COLOR BOX

GB Cordless hedge trimmer (tool only)
 D Akku-Heckenschere (nur das Gerät)
 PL Akumulatorowe nożyce do żywopłotu (tylko narzędzie)
 RUS Аккумуляторные ножицы (только инструмент)
 CZ Akumulátorové nůžky na živé ploty (pouze nářadí)
 H Akkus sövénynyíró (csak a szerszámot)
 RO Foarfece de tăiat gard viu cu acumulator (numai scula)
 F Taille-haies sans-fil (outil seulement)
 I Tagliasiepi a batteria (solo utensile)
 E Tijera cortasetos a batería (herramienta solamente)
 CN 充电式高枝剪 (光机)

18 V Li-Ion
 1h*
 2100 min*
 420 mm

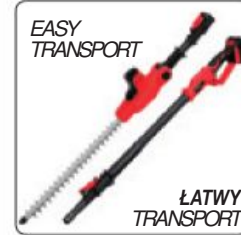

$L_{pA} = 77,3 \pm 3,0$ dB;
 $L_{pM} = 88,1 \pm 3,0$ dB;
 $a_n = 1,5 \pm 1,5$ m/s²

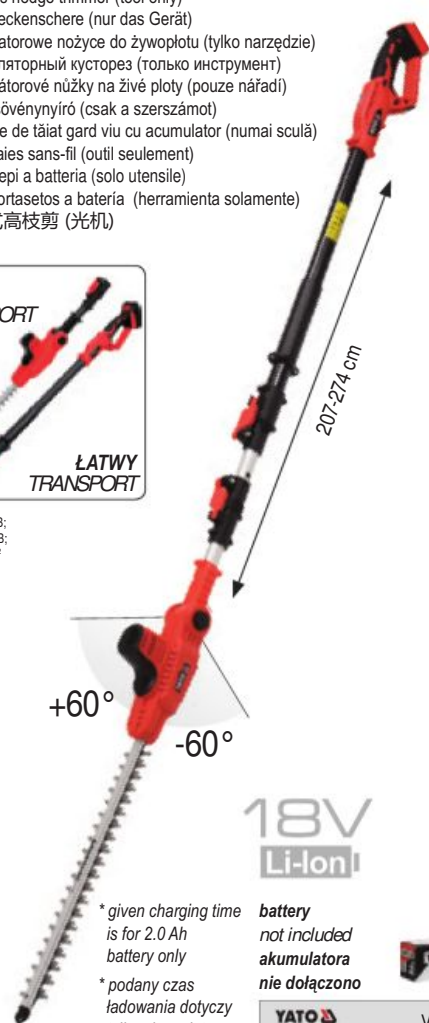

18V Li-Ion
 * given charging time is for 2.0 Ah battery only
 * podany czas ładowania dotyczy tylko akumulatora 2.0 Ah
 battery not included
 akumulatora nie dołączono
 YATO V
 YT-82835 18 2
 COLOR BOX

GB Battery
 D Akkumulator
 PL Akumulator
 RUS Зарядное устройство
 CZ Akumulátor
 H Akkutöltő
 RO Acumulatorul
 F Batterie
 I Batteria
 E Bateria
 CN 锂电池

18 V 3.0 Ah 54 Wh Li-Ion



WHITE CARTON BOX & COLOR LABEL

for / dla: YT-85080, YT-85100, YT-85110, YT-85120

YATO	V	
YT-85130	18	18

GB Battery charger
 D Ladegerät
 PL Ładowarka
 RUS Зарядное устройство
 CZ Nabíječka
 H Akkutöltő
 RO Redresor
 F Chargeur de batterie
 I Caricabatteria
 E Rectificador
 CN 充电器

for/dla: 18V 230V-50Hz for/dla: Li-Ion



WHITE CARTON BOX & COLOR LABEL

for / dla: YT-85080, YT-85100, YT-85110, YT-85120, YT-85130

YATO	V	
YT-85131	18	27

18

GB Battery
 D Akkumulator
 PL Akumulator
 RUS Аккумулятор
 CZ Akumulátor
 H Akkutöltő
 RO Acumulatorul
 F Batterie
 I Batteria
 E Bateria
 CN 锂电池

18 V Li-Ion for/dla: Li-Ion



COLOR BOX

for / dla: YT-82830, YT-82831, YT-82832, YT-82833, YT-82834, YT-82835, YT-82836, YT-82837

YATO	V	capacity / pojemność (Ah)	charging time / czas ładowania (h)	
YT-82842	18	2.0	1.0	20
YT-82843	18	3.0	1.5	20
YT-82844	18	4.0	2.0	20

GB Battery charger
 D Ladegerät
 PL Ładowarka
 RUS Зарядное устройство
 CZ Nabíječka
 H Akkutöltő
 RO Redresor
 F Chargeur de batterie
 I Caricabatteria
 E Rectificador
 CN 充电器

for/dla: 18V for/dla: Li-Ion 220-240V-50/60Hz



COLOR BOX

for / dla: YT-82830, YT-82831, YT-82832, YT-82833, YT-82834, YT-82835, YT-82836, YT-82837

YATO	V	
YT-82848	18	10

- GB Electric lawn mower
D Elektrischer grasmäher
PL Kosiarka elektryczna
RUS Электрокосилка
CZ Elektrická sekačka
H Elektromos fűnyíró-gép
RO Cositoare electrica pt. iarba
F Tondeuse à gazon électrique
I Tosaerba elettrici
E Contracesped
CN 电动草坪机

$L_{pa} = 82,3 \pm 3,0$ dB;
 $L_{wa} = 93,1 \pm 1,91$ dB;
 $a_s = 2,72 \pm 1,5$ m/s²



YATO	W	
YT-85200	1300	1

- GB Electric lawn mower
D Elektrischer grasmäher
PL Kosiarka elektryczna
RUS Электрокосилка
CZ Elektrická sekačka
H Elektromos fűnyíró-gép
RO Cositoare electrica pt. iarba
F Tondeuse à gazon électrique
I Tosaerba elettrici
E Contracesped
CN 电动草坪机

$L_{pa} = 82,8 \pm 3,0$ dB;
 $L_{wa} = 93,7 \pm 2,4$ dB;
 $a_s = 3,15 \pm 1,5$ m/s²



YATO	W	
YT-85205	1800	1

- GB Electric lawn mower
D Elektrischer grasmäher
PL Kosiarka elektryczna
RUS Электрокосилка
CZ Elektrická sekačka
H Elektromos fűnyíró-gép
RO Cositoare electrica pt. iarba
F Tondeuse à gazon électrique
I Tosaerba elettrici
E Contracesped
CN 电动草坪机

$L_{pa} = 83,6 \pm 3,0$ dB;
 $L_{wa} = 94,6 \pm 1,80$ dB;
 $a_s = 3,45 \pm 1,5$ m/s²

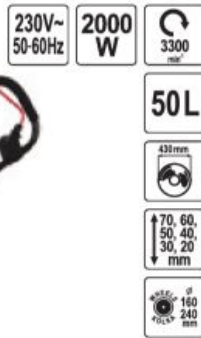

YATO	W	
YT-85208	2000	1

- GB Gasoline backpack sprayer
D Benzin Motorsprüher
PL Opryskiwacz plecakowy spalinowy
RUS Бензиновый ранец-опрыскиватель
CZ Motorový rosič
H Benzines permetező
RO Pulverizatoare pe benzina
F Pulvérisateur a essence
I Atomizzatore
E Pulverizador de gasolina
CN 喷雾喷粉机

$L_{pa} = 78,8 \pm 3,0 / 97,8 \pm 3,0$ dB;
 $L_{wa} = 89,8 \pm 3,0 / 108,8 \pm 3,0$ dB;
 $a_s = 1,94 \pm 1,5 / 8,93 \pm 1,5$ m/s²



WHITE
CARTON BOX
& COLOR
LABEL



YATO	kW	KM	
YT-85140	2.13	2.9	1

- GB Gasoline chainsaw
D Motorsägen
PL Piłarka spalinowa
RUS Бензопила
CZ Motorová pila
H Benzin lánkfűrés
- RO Drujba pe benzina
F Tronçonneuses
I Motosega a benzina
E Motosierra de gasolina
CN 油锯

$L_{pa} = 93,35 \pm 1,08$ dB;
 $L_{wa} = 112,33 \pm 1,08$ dB;
 $a_s = 5,600 \pm 1,5 / 4,884 \pm 1,5$ m/s²

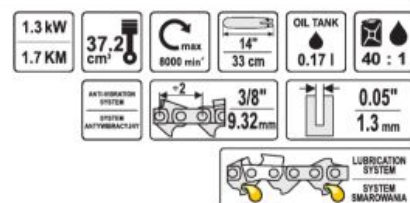

YATO	kW	KM	L (mm)	
YT-84895	1.3	1.7	330	1

- GB Gasoline chainsaw
D Motorsägen
PL Piłarka spalinowa
RUS Бензопила
CZ Motorová pila
H Benzin lánkfűrés
- RO Drujba pe benzina
F Tronçonneuses
I Motosega a benzina
E Motosierra de gasolina
CN 油锯

$L_{pa} = 89,69 \pm 1,37$ dB;
 $L_{wa} = 109,19 \pm 1,37$ dB;
 $a_s = 5,650 \pm 1,5 / 6,027 \pm 1,5$ m/s²

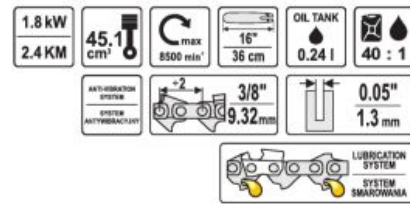

YATO	kW	KM	L (mm)	
YT-84901	1.8	2.4	360	1

GB Gasoline chainsaw
D Motorsägen
PL Piarka spalinowa
RUS Бензопила
CZ Motorová pila
H Benzin láncfűrész
RO Drujba pe benzina
F Tronçonneuses
I Motosega a benzina
E Motosierra de gasolina
CN 油锯

2.5 kW
3.4 KM
56.5 cm³
8500 min⁻¹
20" / 48 cm
OIL TANK 0.24 l
40 : 1
ANTIVIBRATION SYSTEM ANTIVIBRACIJA
0.325" / 8.25 mm
0.058" / 1.5 mm
LUBRICATION SYSTEM SYSTEM SMAROCANIA



L_{pa} = 94.59 ± 1.34 dB;
L_{wa} = 113.46 ± 1.34 dB;
a_w = 7.234 ± 1.5 / 9.528 ± 1.5 m/s²

COLOR BOX

YATO	kW	KM	L (mm)	Box
YT-84910	2.5	3.4	480	1

GB Brushcutter
D Motorsensen
PL Kosa spalinowa
RUS Бензокоса
CZ Motorový křovinořez
H Motoros kasza
RO Motocoasa
I Falce fienăia a benzina
E Motoguadaña de gasolina
CN 割草机

0.8 kW
1.1 KM
29.3 cm³
255 mm
430 mm
ANTIVIBRATION SYSTEM ANTIVIBRACIJA
40 : 1
0.48L
EASY START LATWY ROZRUCH



L_{pa} = 92.63 ± 2.5 dB;
L_{wa} = 109.41 ± 2.5 dB;
a_w = 4.617 ± 1.5 / 4.007 ± 1.5 m/s²

COLOR BOX

YATO	kW	KM	Box
YT-85001	0.8	1.1	1

GB Brushcutter
D Motorsensen
PL Kosa spalinowa
RUS Бензокоса
CZ Motorový křovinořez
H Motoros kasza
RO Motocoasa
I Falce fienăia a benzina
E Motoguadaña de gasolina
CN 割草机

1.25 kW
1.7 KM
42.7 cm³
255 mm
430 mm
ANTIVIBRATION SYSTEM ANTIVIBRACIJA
40 : 1
0.85L
EASY START LATWY ROZRUCH



L_{pa} = 96.3 ± 3.0 dB;
L_{wa} = 110.3 ± 3.0 dB;
a_w = 3.992 ± 1.5 / 10.403 ± 1.5 m/s²

COLOR BOX

YATO	kW	KM	Box
YT-85003	1.25	1.7	1

GB Brushcutter
D Motorsensen
PL Kosa spalinowa
RUS Бензокоса
CZ Motorový křovinořez
H Motoros kasza
RO Motocoasa
I Falce fienăia a benzina
E Motoguadaña de gasolina
CN 割草机

1.25 kW
1.7 KM
42.7 cm³
255 mm
430 mm
40 : 1
1L



L_{pa} = 88.59 ± 5.29 dB;
L_{wa} = 106.65 ± 5.29 dB;
a_w = 12.479 ± 1.5 / 4.692 ± 1.5 m/s²

COLOR BOX

YATO	kW	KM	Box
YT-85000	1.25	1.7	1

GB Petrol hedge trimmer
D Benzin-Heckenscheren
PL Spalinowe nożycy do żywoplotu
RUS Бензоножицы
CZ Plotostřih na živé ploty
H Benzines sövényvágó
RO Tuns gard viu
F Taille-haie
I Tosasièpi per privati
E Corta sebes a gasolina
CN 绿篱剪

0.7 kW
0.99 KM
25.4 cm³
7000 min⁻¹
1850 mm²
40 : 1
0.6L



L_{pa} = 96 ± 3 dB;
L_{wa} = 105.3 ± 0.48 dB;
a_w = 6.9 ± 1.5 m/s²

COLOR BOX

YATO	kW	KM	L (mm)	Box
YT-85021	0.7	0.99	550	1

GB Chainsaw guide bar
D Kettensägeführung
PL Prowadnica
do pił łańcuchowych

RUS Шина для бензопил
CZ Vodící lišta k řetězové pile
H Lánčvezető

RO Lama de ghidai pt. ferastrau
F Guide de tronçonneuse
I Barra per motosega

E Barra guía motosierra
CN 导轨

COLOR
PAPER
POUCH

Mn
65



for / dla: YT-84948, YT-84960

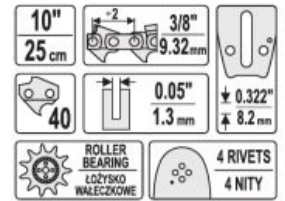

YATO	size / rozmiar	
YT-84925	10" (25 cm)	20



for / dla: YT-84949, YT-84960

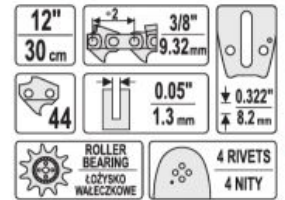

YATO	size / rozmiar	
YT-84927	12" (30 cm)	20



for / dla: YT-8499395, YT-84963

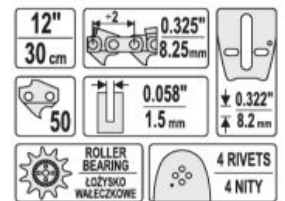

YATO	size / rozmiar	
YT-84928	12" (30 cm)	20



for / dla: YT-84950, YT-84960

competitors / odpowiedniki: Oregon: 140SPEA074; Alpina: 4112560; Stihl: 3005 000 809; Windsor: 14ST50SSR
for / dla: Alpina: 270, 280, Elletra 160, Elletra 170, Energy 1.6, Energy 1.8, P360, P361, P370, P390, P391, Sinergy 35, Sinergy 40; Oleo-Mac: 240, OEM200; Stihl: 009, 010, 011, 012, 017, 018, 019, 019T, 020, 020T, 021, 021C, 023, 025, 25, MS160, MS170, MS180, MS181, MS191, MS192, MS200, MS200T, MS210, MS211, MS230, MS231, MS241, MS250, MS251, MSE140, MSE200

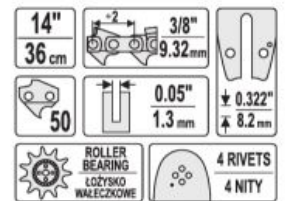

YATO	size / rozmiar	
YT-84930	14" (36 cm)	20



for / dla: YT-84951, YT-84960

competitors / odpowiedniki: Oregon: 140SDEA041; Oleo-mac: 50030218; Husqvarna: 501854149; Windsor: 14PKU50SSR; Makita: 442035661, 472035661, 482035661; Alpina: 4112300; Dolmar: 412035661, 452035661, 462035661; Partner: 530044328

for / dla: Al-Ko: 2000, 2300, 25A, E1200, E125, E1400, E1500, KE3500, VARIO, KE4000, KS, KSB; Alpina: 352, 382, A10E, A14E, E120, E130, E150, ELECTRIC, ES182, ES202, KS1400B, KS1500B; Bosch: 1586, 40-19PRO, AKE30B, AKE30LI, AKE35-19PRO, AKE35B, AKE40B, BULLCRAFT, GKE35BC, GKE40BC, PKE25, PKE30B, PKE35B, PKE40; Dolmar: 100, 101, 102, 103, 104, 105, 106, 108, 275, 285, ES140, ES151, ES152, ES152A, ES153, ES160, ES161, ES162, ES162A, ES163, ES172, ES172A, ES173, ES183, ES2035, ES2040, ES3, ES30, ES37, ES40, ES41, ES6, PS33, PS330, PS3300TH, PS34, PS340, PS341, PS3410, PS344, PS350, PS390, PS400, PS401, PS41, PS45; Echo: CS2600ES, CS260TES, CS2700ES, CS310WES, CS3500ES, CS350WES, CS351WES; Einhell: BG-EC-1840TC, BG-PC-4040, EKS1650, KSE, KSE1435, KSE1635, KSE1640, KSE2000, PES1540, PES1640, PES30, PES34, PES35, PES40, PKS1635, PKS1840, PROFI; Hitachi: CS280A, CS280B, CS30EH, CS350A, CS350B, CS35B; Homelite: 20AV, 23AV, 27, 3300, 3335, 350, 3550, 3800, 3850, 4500, 4550, S40, HCS3335, HCS4041CA, PS33, RANGER, TIMBERMAN, UT10901, UT10926, UT10974; Husqvarna: 23, E16, E316, E317, E321, T425; Jonsered: 2033TH; Makita: 5012, 5014, 5016, BUC122RFE, BUC250RDE, DCS232T, DCS300, DCS330S, DCS340, DCS341, DCS3410TH, DCS350, DCS3501, DCS380, DCS390, DCS400, DCS401, DCS4610, EA3201, EA3500F35B, EA3500F40B, UC250DWB, UC3000, UC3030A, UC3500, UC3501, UC3520A, UC3530AK, UC4000, UC4020A, UC4030AK, UC4530A; McCulloch: 10-42, 10-49, 335, 435, 440, 441, 442, 4600, 4700, 4900, 5000, 738, TIMBERBEAR-849, TITAN41, TITAN46; Oleo-Mac: 931, 932, GS35, GS350, GS370, GS410C; Partner: 330, 335, 340, 345, 350, 351, 352, 360, 370, 385, 391, 395, P390, P420, P842; Ryobi: APR02, PCN3335; Skil: 1620U, 1634U, 1636U

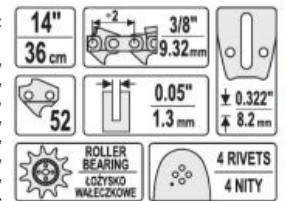

YATO	size / rozmiar	
YT-84931	14" (36 cm)	20



for / dla: YT-84940, YT-84963

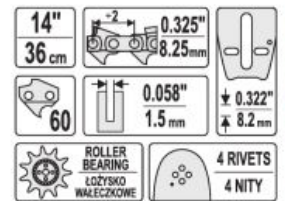

YATO	size / rozmiar	
YT-849311	14" (36 cm)	20

GB Chainsaw guide bar
D Kettensägeführung
PL Prowadnica
do pil łańcuchowych

RUS Шина для бензопил
CZ Vodící lišta k řetězové pile
H Láncevetető

RO Lama de ghidai pt. ferastrau
F Guide de tronçonneuse
I Barra per motosega

E Barra guía motosierra
CN 导板

COLOR
PAPER
POUCH

Mn
65



for / dla: YT-84961

competitors / odpowiedniki: Oregon: 158SLHD009; Husqvarna: 508914356; Windsor: 15HS58SPNA

for / dla: Alpina: P660, P690, P700, P750, P800, PROF700, PROF800; Dolmar: PS6400, PS6400H, PS7300, PS7300H, PS7900, PS7900H, PS9000, PS9010; Dolpima: PS190, PS290, PS390, PS490; Echo: CS3500, CS350WES, CS351WE; Husqvarna: 1100, 160, 162, 181, 2100XP, 2101, 2101XP, 260, 266, 268, 272, 281XP, 285, 288XP, 298, 298X, 298XG, 3120, 3120XP, 365, 371, 371XP, 371XPG, 372, 372XP, 372XPG, 380, 385, 385XP, 394, 394XP, 394XPG, 395, 395XP, 395XPG, 480, 562XP, 570, 575, 575XP, 576XP, 61, 64, 65, 66, 70, 77; Jonsered: 1020, 2065, 2071, 2077, 2083, 2094, 2095, 2165, 2171, 2186, 625, 630, 630 SUPER, 670, 670 CHAMP, 820; Makita: DCS6400, DCS6401, DCS7300, DCS7301, DCS7900, DCS79001, DCS9000, DCS9010; Partner: 660, 710, P7700; Solo: 603, 662, 665, 667, 670, 675, 680, 681, 690, 694

15" 38 cm

3/8" 9.32mm

56

0.058" 1.5 mm

± 0.355" ± 9.0 mm

ROLLER BEARING ŁOŻYSKO WALECZKOWE

4 RIVETS 4 NITY

YATO	size / rozmiar	
YT-84932	15" (38 cm)	20



for / dla: YT-84952, YT-84960

for / dla: YT-84905, YT-84945, YT-84962

competitors / odpowiedniki: Oregon: 50MLBK095; Dolmar: 415038141; Husqvarna: 508926164, 508926364; Makita: 445038141; Windsor: 15CJL50SPYJ

for / dla: Dolmar: 109, 110, 111, 112, 113, 114, 115i, 116, PS460, PS4600, PS4605, S500, PS5000, PS510, PS5100S, PS540; Husqvarna: 133, 136, 137, 141, 142, 154, 234, 238, 240, 242, 242XP, 246, 254, 257, 261, 262, 339XP, 340, 345, 346, 346XP, 350, 351, 353, 357, 357XP, 359, 36, 40, 41, 42, 435, 435E, 44, 440E, 444, 445, 445E, 45, 450E, 455 RANCHER, 455E RANCHER, 460, 460 RANCHER, 50, 51, 550, 560XP, T435; Jonsered: 2012, 2014, 2015, 2016, 2036, 2040, 2041, 2045, 2050, 2051, 2054, 2055, 2063, 2141, 2145, 2147, 2149, 2150, 2152, 2153, 2155, 2156, 2159, 2163, 370, 380, 410, 420, 425, 435, 45, 450, 451, 451EVS, 452, 455, 490, 49SP, 50, 51, 510, 52, 520, 521, 525, 535, 590, CS2149W, CS2152W; Makita: 45, DCS430, DCS43001, DCS4300I, DCS431, DCS460, DCS4600S, DCS500, DCS5000, DCS5030, DCS520, DCS5200I; Oleo-Mac: 850, 938, 940, 941, 942, 942C, 945, 946, 947, 950, 950 Super, 950A, 951, 952, 956, 962 E300F, GS410CX, GS44; Partner: 1200EL, 1400EL, 1450EL, 1500EL, 1650EL, 365, 400, 405, 410, 450, 460, 465, 470, 495, 500, 510, 540, 545, P500, P5000, P5500; Solo: 639, 641, 644, 645, 647, 650, 651, 652, 656, 665

15" 38 cm

3/8" 9.32mm

56

0.05" 1.3 mm

± 0.322" ± 8.2 mm

ROLLER BEARING ŁOŻYSKO WALECZKOWE

4 RIVETS 4 NITY

YATO	size / rozmiar	
YT-84933	15" (38 cm)	20



for / dla: YT-84900, YT-84941, YT-84963

competitors / odpowiedniki: Oregon: 158PXBK095; Dolmar: 415038631; Husqvarna: 508912164, 508912364; Makita: 445038631; Solo: 6900343, 6900343K, 6900343N

for / dla: Dolmar: 109, 110, 111, 112, 113, 114, 115i, 116, ES1800, PS460, PS4600, PS4605, PS500, PS5000, PS510, PS5100S, PS540; Homelite: 250, 252, 290, 290C, 300, 340, 340C, 3850B, 3850C, 4045, 415B, 444, 4550B, HCS4040, HCS4446CA; Husqvarna: 133, 136, 137, 141, 142, 154, 234, 235, 238, 240, 242, 242XP, 246, 254, 257, 261, 262, 339XP, 340, 345, 346, 346XP, 350, 351, 353, 357, 357XP, 359, 36, 40, 41, 42, 435, 435E, 44, 440, 440E, 444, 445, 445E, 45, 450E, 455 RANCHER, 455E RANCHER, 460, 460 RANCHER, 50, 51, 550, 560XP, T435; Jonsered: 2012, 2014, 2015, 2016, 2036, 2040, 2041, 2045, 2050, 2051, 2054, 2055, 2063, 2141, 2145, 2147, 2149, 2150, 2152, 2153, 2155, 2156, 2159, 2163, 370, 380, 410, 420, 425, 435, 45, 450, 451, 451EVS, 452, 455, 490, 49SP, 50, 51, 510, 52, 520, 521, 525, 535, 590, CS2149W, CS2152W; Makita: 45, DCS430, DCS43001, DCS4300I, DCS431, DCS460, DCS4600S, DCS500, DCS5000, DCS5030, DCS520, DCS5200I; NAC: NO-CS38, SPS01-45, SPS01-52, SPS02-45, YD 40/45, YD40, YD52; Oleo-Mac: 850, 938, 940, 941, 942, 942C, 945, 946, 947, 950, 950 Super, 950A, 951, 952, 956, 962, E300F; Partner: 365, 400, 405, 410, 450, 460, 465, 470, 495, 500, 510, 540, 545, P500, P5000, P5500

15" 38 cm

3/8" 9.32mm

64

0.058" 1.5 mm

± 0.322" ± 8.2 mm

ROLLER BEARING ŁOŻYSKO WALECZKOWE

4 RIVETS 4 NITY

YATO	size / rozmiar	
YT-84934	15" (38 cm)	20



for / dla: YT-84953, YT-84960

competitors / odpowiedniki: Oregon: 160SDEA041; Oleo-Mac: 50050092; Husqvarna: 530044508; Windsor: 16PKU50SSR; Makita: 442040661, 442040661; Alpina: 4112500; Partner: 530044329

for / dla: Al-Ko: 2000, 2300, 25A, E1200, E125, E1400, E1500, KE3500 VARIO, KE4000, KS, KSB; Alpina: 352, 382, A10E, A14E, E120, E130, E150, ELECTRIC ES182, ES202, KS1400B, KS1500B; Dolmar: 100, 101, 102, 103, 104, 105, 106, 108, 275, 285, ES140, ES151, ES152, ES152A, ES153, ES160, ES161, ES162, ES162A, ES163, ES172, ES172A, ES173, ES183, ES2035, ES2040, ES3, ES30, ES37, ES40, ES41, ES6, PS33, PS330, PS3300TH, PS34, PS340, PS341, PS3410, PS344, PS350, PS390, PS400, PS401, PS41, PS45; Echo: CS2600ES, CS260TES, CS2700ES, CS310WES, CS3500ES, CS350WES, CS351WES, CS360WES; Hitachi: CS280A, CS280B, CS350A, CS350B, CS35B; Homelite: 20AV, 23AV, 27, 3300, 3335, 3350, 3550, 3800, 3850, 4500, 4550, CS40, HCS3335, HCS4041CA, PS33, RANGER, TIMBERMAN, UT10901, UT10926, UT10974; Husqvarna: 23, E16, E316, E317, E321, T425; Jonsered: 2033TH; Makita: 5012, 5014, 5016, BUC122RFE, BUC250RDE, DCS230T, DCS232T, DCS300, DCS300S, DCS330, DCS330S, DCS34, DCS340, DCS341, DCS3410TH, DCS350, DCS3500, DCS3501, DCS3520A, DCS380, DCS390, DCS400, DCS401, DCS4610, UC3000, UC3030A, UC3500, UC3501, UC3520A, UC3530AK, UC4000, UC4030AK; McCulloch: 338, 442; Oleo-Mac: 931, 932, GS35, GS350, GS370, GS410C; Partner: 330, 335, 340, 345, 350, 351, 352, 360, 370, 385, 391, 395, P390, P420, P842; Ryobi: APR02, PCN3335

16" 40 cm

3/8" 9.32mm

56

0.05" 1.3 mm

± 0.322" ± 8.2 mm

ROLLER BEARING ŁOŻYSKO WALECZKOWE

4 RIVETS 4 NITY

YATO	size / rozmiar	
YT-84935	16" (40 cm)	20



for / dla: YT-84942, YT-84963

16" 40 cm

3/8" 9.32mm

66

0.058" 1.5 mm

± 0.322" ± 8.2 mm

ROLLER BEARING ŁOŻYSKO WALECZKOWE

4 RIVETS 4 NITY

YATO	size / rozmiar	
YT-849351	16" (40 cm)	20

GB Chainsaw guide bar
D Kettensägeführung
PL Prowadnica do pił łańcuchowych

RUS Шина для бензопил
CZ Vodicí lišta k řetězové pile
H Lánčvezető

RO Lama de ghidai pt. ferastrau
F Guide de tronçonneuse
I Barra per motosega
E Barra guia motosierra
CN 导轨

COLOR PAPER POUCH



for / dla: YT-84956, YT-84960

18" 45 cm		3/8" 9.32 mm		Mn 65
	62	0.05" 1.3 mm	± 0.322" ± 8.2 mm	
	ROLLER BEARING ŁOŻYSKO WALECZKOWE		4 RIVETS 4 NITY	
YATO size / rozmiar		YT-849355 18" (45 cm) 20		



for / dla: YT-84900, YT-84943, YT-84963

competitors / odpowiedniki: Oregon: 188SLGK095; Dolmar: 415045631; Makita: 415045631; Windsor: 18CJL58SPYJ9

for / dla: Dolmar: 109, 110, 111, 112, 113, 114, 115, 116, ES1800, PS460, PS460S, PS500, PS5000, PS510, PS5100S, PS540; Homelite: 250, 252, 290, 290C, 300, 340, 340C, 3850B, 3850C, 4045, 415B, 444, 4550B, HCS4040, HCS4446CA; Husqvarna: 133, 136, 137, 141, 142, 154, 234, 238, 240, 242, 242XP, 246, 254, 257, 261, 262, 339XP, 340, 345, 346, 346XP, 350, 351, 353, 357, 357XP, 359, 36, 40, 41, 42, 435, 435E, 44, 440, 440E, 444, 445, 445E, 45, 450E, 455 RANCHER, 455E RANCHER, 460, 460 RANCHER, 50, 51, 550, 560XP, T435; Jonsered: 2012, 2014, 2015, 2016, 2036, 2040, 2041, 2045, 2050, 2051, 2054, 2055, 2063, 2141, 2145, 2147, 2149, 2150, 2152, 2153, 2155, 2156, 2159, 2163, 370, 380, 410, 420, 425, 435, 45, 450, 451, 451EVS, 452, 455, 490, 49S, P50, 51, 510, 52, 520, 521, 525, 535, 590, CS2149W, CS2152W; Makita: 45, DCS430, DCS43001, DCS4300I, DCS431, DCS460, DCS4600S, DCS500, DCS5000, DCS5030, DCS520, DCS5200I; NAC: NO-CS38, SPS01-45, SPS01-52, SPS02-45, YD 40/45, YD40, YD52; Oleo-Mac: 850, 938, 940, 941, 942, 942C, 945, 946, 947, 950, 950 Super, 950A, 951, 952, 956, 962, E300F; Partner: 365, 400, 405, 410, 450, 460, 465, 470, 495, 500, 510, 540, 545, P500, P5000, P5500; Solo: 639, 641, 644, 645, 647, 650, 651, 652, 656, 665

18" 45 cm		0.325" 8.25 mm		Mn 65
	72	0.058" 1.5 mm	± 0.322" ± 8.2 mm	
	ROLLER BEARING ŁOŻYSKO WALECZKOWE		4 RIVETS 4 NITY	
YATO size / rozmiar		YT-84936 18" (45 cm) 20		



for / dla: YT-84944, YT-84963

20" 50 cm		0.325" 8.25 mm		Mn 65
	76	0.058" 1.5 mm	± 0.322" ± 8.2 mm	
	ROLLER BEARING ŁOŻYSKO WALECZKOWE		4 RIVETS 4 NITY	
YATO size / rozmiar		YT-84937 20" (50 cm) 20		

GB Chain for chainsaw
D Kette für Kettensägen
PL Łańcuch tnący do pił
RUS Цепь для бензопил

CZ Řetěz pro řetězové pily
H Lánč lánčfűrész
RO Lant pt. drujba
F Chaîne de tronçonneuse

I Taglio per motoseghea
E Cadena de motosierra
CN 蠟沫

COLOR BOX WITH EURO HOLE



for / dla: YT-84928

12" 30 cm		0.325" 8.25 mm		Mn 65
	50	0.058" 1.5 mm	± 0.322" ± 8.2 mm	
	KICKBACK REDUCTION REDUKCIJA ODRZUTU		VIBRATION REDUCTION REDUKCIJA WIBRACJI	
YATO size / rozmiar		YT-849395 12" (30 cm) 50		



for / dla: YT-84900

for / dla: Alpina: A40, A40E, P400, P450, P460, P500, P510, P522, PRO540, PRO600, PROF-41, PROF-45; Dolmar: 109, 110, 111, 112, 113, 114, 115i, 116, ES1800, PS460, PS4600, PS460S, PS500, PS5000, PS510, PS5100S, PS540; Echo: CS4200ES, CS4400; Homelite: 250, 252, 290, 290C, 300, 340, 340C, 3850B, 3850C, 415B, 444, 4550B, HCS4040, HCS4045, HCS4446CA; Husqvarna: 133, 136, 137, 140, 141, 142, 154, 234, 235, 238, 240, 240e, 242, 242XP, 246, 254, 254XP, 257, 261, 262, 338XP, 339XP, 340, 345, 346, 346XP, 350, 351, 353, 357, 357XP, 359, 36, 365, 40, 41, 42, 435, 435E, 44, 440E, 444, 445, 445E, 45, 450E, 455 RANCHER, 455E ANCHER, 460, 460 RANCHER, 50, 51, 55; Jonsered: 2012, 2014, 2015, 2016, 2036, 2040, 2041, 2045, 2050, 2051, 2054, 2055, 2063, 2141, 2145, 2147, 2149, 2150, 2152, 2153, 2155, 2156, 2159, 2163, 370, 380, 410, 420, 425, 435, 45, 450, 451, 451EVS, 452, 455, 490, 49SP, 50, 51, 510, 52, 521, 525, 535, 590, CS2149W, CS2152W; Makita: 45, DCS430, DCS43001, DCS4300I, DCS431, DCS460, DCS4600S, DCS4630, DCS500, DCS5000, DCS5030, DCS520, DCS5200I; NAC: NO-CS38, SPS01-45, SPS01-52, SPS02-45, YD 40/45, YD40, YD52; Oleo-Mac: 850, 938, 940, 941, 942, 945, 946, 947, 950, 950 Super, 950A, 951, 952, 956, 962, E300F; Partner: 1650, 365, 400, 405, 410, 450, 460, 465, 470, 495, 500, 510, 540, 545, P500, P5000, P5500

14" 36 cm		0.325" 8.25 mm		Mn 65
	56	0.058" 1.5 mm	± 0.322" ± 8.2 mm	
	KICKBACK REDUCTION REDUKCIJA ODRZUTU		VIBRATION REDUCTION REDUKCIJA WIBRACJI	
YATO size / rozmiar		YT-84940 14" (36 cm) 50		



for / dla: YT-84900, YT-84934

for / dla: Dolmar: 109, 110, 111, 112, 113, 114, 115i, 116, ES1800, PS460, PS4600, PS460S, PS500, PS5000, PS5510, PS5100S, PS540; Husqvarna: 154, 257, 440e, 133, 136, 137, 140, 141, 142, 234, 235, 238, 240, 240e, 242, 242XP, 246, 254, 254XP, 261, 262, 338XP, 339XP, 340, 345, 346, 346XP, 350, 351, 353, 357, 357XP, 359, 36, 365, 372XP, 40, 41, 42, 435, 435E, 44, 444, 445, 445E, 45, 450E, 455 RANCHER, 455E RANCHER, 460 RANCHER, 50, 51, 55, T435; Jonsered: 520, 2012, 2014, 2015, 2016, 2036, 2040, 2041, 2045, 2050, 2051, 2054, 2055, 063, 2141, 2145, 2147, 2149, 2150, 2152, 2153, 2155, 2156, 2159, 2163, 370, 380, 410, 420, 425, 435, 45, 450, 451, 451EVS, 452, 455, 490, 49SP, 50, 51, 510, 52, 521, 525, 535, 590, CS2149W, CS2152W; Makita: 45, DCS430, DCS43001, DCS4300I, DCS431, DCS460, DCS4600S, DCS4630, DCS500, DCS5000, DCS5030, DCS520, DCS5200I; NAC: NO-CS38, SPS01-45, SPS01-52, SPS02-45, YD 40/45, YD40, YD52; Oleo-Mac: 850, 938, 940, 941, 942, 945, 946, 947, 950, 950 Super, 950A, 951, 952, 956, 962, E300F; Partner: 1650, 365, 400, 405, 410, 450, 460, 465, 470, 495, 500, 510, 540, 545, P500, P5000, P5500

15" 38 cm		0.325" 8.25 mm		Mn 65
	64	0.058" 1.5 mm	± 0.322" ± 8.2 mm	
	KICKBACK REDUCTION REDUKCIJA ODRZUTU		VIBRATION REDUCTION REDUKCIJA WIBRACJI	
YATO size / rozmiar		YT-84941 15" (38 cm) 50		



for / dla: YT-84900

for / dla: Dolmar: 109, 110, 111, 112, 113, 114, 115i, 116, ES1800, PS460, PS4600, PS460S, PS500, PS5000, PS5510, PS5100S, PS540; Husqvarna: 154, 257, 440e, 133, 136, 137, 140, 141, 142, 234, 235, 238, 240, 240e, 242, 242XP, 246, 254, 254XP, 261, 262, 338XP, 339XP, 340, 345, 346, 346XP, 350, 351, 353, 357, 357XP, 359, 36, 365, 372XP, 40, 41, 42, 435, 435E, 44, 444, 445, 445E, 45, 450E, 455 RANCHER, 455E RANCHER, 460 RANCHER, 50, 51, 55, T435; Jonsered: 520, 2012, 2014, 2015, 2016, 2036, 2040, 2041, 2045, 2050, 2051, 2054, 2055, 063, 2141, 2145, 2147, 2149, 2150, 2152, 2153, 2155, 2156, 2159, 2163, 370, 380, 410, 420, 425, 435, 45, 450, 451, 451EVS, 452, 455, 490, 49SP, 50, 51, 510, 52, 521, 525, 535, 590, CS2149W, CS2152W; Makita: 45, DCS430, DCS43001, DCS4300I, DCS431, DCS460, DCS4600S, DCS4630, DCS500, DCS5000, DCS5030, DCS520, DCS5200I; NAC: NO-CS38, SPS01-45, SPS01-52, SPS02-45, YD 40/45, YD40, YD52; Oleo-Mac: 850, 938, 940, 941, 942, 945, 946, 947, 950, 950 Super, 950A, 951, 952, 956, 962, E300F; Partner: 1650, 365, 400, 405, 410, 450, 460, 465, 470, 495, 500, 510, 540, 545, P500, P5000, P5500

16" 40 cm		0.325" 8.25 mm		Mn 65
	66	0.058" 1.5 mm	± 0.322" ± 8.2 mm	
	KICKBACK REDUCTION REDUKCIJA ODRZUTU		VIBRATION REDUCTION REDUKCIJA WIBRACJI	
YATO size / rozmiar		YT-84942 16" (40 cm) 50		

GB Chain for chainsaw
D Kette für Kettensägen
PL Łańcuch łańcuch do piły
RUS Цепь для бензопилы

CZ Řetěz pro řetězové pily
H Lånc l ncf r sz
RO Lant pt. drijba
F Cha ne de tron onneuse

I Taglio per motoseghea
E Cadena de motosierra
CN  蠕沫

COLOR BOX
WITH EURO HOLE



for / dla: YT-84900, YT-84936



for / dla: Dolmar: 109, 110, 111, 112, 113, 114, 115i, 116, ES1800, PS460, PS4600, PS4605, PS500, PS5000, PS5510, PS5100S, PS540; Husqvarna: 154, 257, 440e, 133, 136, 137, 140, 141, 142, 234, 235, 238, 240, 240e, 242, 242XP, 246, 254, 254XP, 261, 262, 338XPT, 339XP, 340, 345, 346, 346XP, 350, 351, 353, 357, 357XP, 359, 36, 365, 372XP, 40, 41, 42, 435, 435E, 44, 444, 445, 445E, 45, 450E, 455 RANCHER, 455E RANCHER, 460 RANCHER, 50, 51, 55, T435; Jonsered: 520, 2012, 2014, 2015, 2016, 2036, 2040, 2041, 2045, 2050, 2051, 2054, 2055, 063, 2141, 2145, 2147, 2149, 2150, 2152, 2153, 2155, 2156, 2159, 2163, 370, 380, 410, 420, 425, 435, 45, 450, 451, 451EVS, 452, 455, 490, 49SP, 50, 51, 510, 52, 521, 525, 535, 590, CS2149W, CS2152W; Makita: 45, DCS430, DCS43001, DCS43001, DCS431, DCS460, DCS4600S, DCS4630, DCS500, DCS5000, DCS5030, DCS520, DCS52001; NAC: NO-CS38, SPS01-45, SPS01-52, SPS02-45, YD 40/45, YD40, YD52; Oleo-Mac: 850, 938, 940, 941, 942, 945, 946, 947, 950, 950 Super, 950A, 951, 952, 956, 962, E300F; Partner: 1650, 365, 400, 405, 410, 450, 460, 465, 470, 495, 500, 510, 540, 545, P500, P5000, P5500



YATO	size / rozmiar	
YT-84943	18" (45 cm)	50

for / dla: YT-84900



for / dla: Dolmar: 109, 110, 111, 112, 113, 114, 115i, 116, ES1800, PS460, PS4600, PS4605, PS500, PS5000, PS5510, PS5100S, PS540; Husqvarna: 154, 257, 440e, 133, 136, 137, 140, 141, 142, 234, 235, 238, 240, 240e, 242, 242XP, 246, 254, 254XP, 261, 262, 338XPT, 339XP, 340, 345, 346, 346XP, 350, 351, 353, 357, 357XP, 359, 36, 365, 372XP, 40, 41, 42, 435, 435E, 44, 444, 445, 445E, 45, 450E, 455 RANCHER, 455E RANCHER, 460 RANCHER, 50, 51, 55, T435; Jonsered: 520, 2012, 2014, 2015, 2016, 2036, 2040, 2041, 2045, 2050, 2051, 2054, 2055, 063, 2141, 2145, 2147, 2149, 2150, 2152, 2153, 2155, 2156, 2159, 2163, 370, 380, 410, 420, 425, 435, 45, 450, 451, 451EVS, 452, 455, 490, 49SP, 50, 51, 510, 52, 521, 525, 535, 590, CS2149W, CS2152W; Makita: 45, DCS430, DCS43001, DCS43001, DCS431, DCS460, DCS4600S, DCS4630, DCS500, DCS5000, DCS5030, DCS520, DCS52001; NAC: NO-CS38, SPS01-45, SPS01-52, SPS02-45, YD 40/45, YD40, YD52; Oleo-Mac: 850, 938, 940, 941, 942, 945, 946, 947, 950, 950 Super, 950A, 951, 952, 956, 962, E300F; Partner: 1650, 365, 400, 405, 410, 450, 460, 465, 470, 495, 500, 510, 540, 545, P500, P5000, P5500



YATO	size / rozmiar	
YT-84944	20" (50 cm)	50

for / dla: YT-84905, YT-84933



for / dla: Dolmar: 109, 110, 111, 112, 113, 114, 115i, 116, PS460, PS4600, S4605, PS500, PS5000, PS510, PS5100S, PS540; Husqvarna: 133, 136, 137, 141, 142, 154, 234, 238, 240, 242, 42XP, 246, 254, 254XP, 257, 261, 262, 338XPT, 339XP, 340, 345, 346, 346XP, 350, 351, 353, 357, 357XP, 359, 36, 65, 40, 41, 42, 435, 435E, 44, 440E, 444, 445, 445E, 45, 450E, 455 RANCHER, 455E RANCHER, 460 RANCHER, 50, 51, 55, T435; Jonsered: 2012, 2014, 2015, 2016, 2036, 2040, 2041, 2045, 2050, 051, 2054, 2055, 2063, 2141, 2145, 2147, 2149, 2150, 2152, 2153, 2155, 2156, 2159, 2163, 370, 380, 410, 420, 425, 435, 45, 450, 451, 451EVS, 452, 455, 490, 49SP, 50, 51, 510, 52, 521, 525, 535, 590, CS2149W, CS2152W; Makita: 45, DCS430, DCS43001, DCS43001, DCS431, DCS460, DCS4600S, DCS4630, DCS500, DCS5000, DCS5030, DCS520, DCS52001; Oleo-Mac: 850, 938, 940, 941, 941C, 942, 945, 946, 947, 950, 950 Super, 950A, 951, 952, 956, 962, E300F, GS350, GS370, GS410CX; Partner: 1200EL, 1400EL, 1450EL, 1500EL, 1650EL, 365, 400, 405, 410, 450, 460, 465, 470, 495, 500, 510, 540, 545, P500, P5000, P5500



YATO	size / rozmiar	
YT-84945	15" (38 cm)	50

for / dla: YT-84925

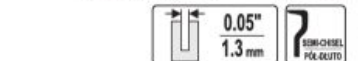

YATO	size / rozmiar	
YT-84948	10" (25 cm)	50

for / dla: YT-84927

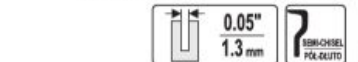
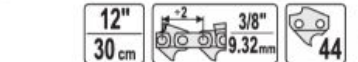

YATO	size / rozmiar	
YT-84949	12" (30 cm)	50

for / dla: Alpina: 270, 280, 330, 380, 432, 438, EURO-40, EURO-45, Elletra 160, Elletra 170, Energy 1.6, Energy 1.8, P360, P370, P390, PR350, Sinergy 35, Sinergy 40; Dolmar: CS2040, PS3300TH; Husqvarna: T425; McCulloch: 3500, 370, 374, 375, 384, 400, 400P, 430, 442, 445, 470, 474, 484, 838, 839, ELECTRA MAC 16E, MAC110, MAC120, MAC130, MAC140, MAC4, MAC6, MAC930, MAC935, MC115, MM30, MM36, PM310, PM320, PM330, PM340, PM36, PM360, PM364, PM370, PM380, PM394, PM400, M470, PM480, PM484, PM510, PM730; Oleo-Mac: 240, OEM200; Partner: 1535EL, 1540, 1540EL, 1640, 1835, 1840, 352, 371, 391, 538E, 542E, P1535, P351; Stihl: 009, 010, 011, 012, 017, 018, 019, 019T, 020, 020T, 021, 021C, 023, 025, 25, MS160, MS170, MS180, MS181, MS191, MS192, MS200, MS200T, MS210, MS211, MS230, MS231, MS241, MS250, MS251, MSE140, MSE200



YATO	size / rozmiar	
YT-84950	14" (36 cm)	50

for / dla: YT-84931



for / dla: Al-Ko: 2000, 2300, 25A, E1200, E125, E1400, E1500, KE3500 VARIO, KE4000, KS, KSB; Alpina: 352, 382, A10E, A14E, E120, E130, E150, ELECTRIC, ES182, ES202, KS1400B, KS1500B; Dolmar: 100, 101, 102, 103, 104, 105, 106, 108, 275, 285, CS2040E, S140, ES151, ES152, ES152A, ES153, ES160, ES161, ES162, ES162A, ES163, ES172, ES172A, ES173, ES183, ES2035, ES2040, ES3, ES30, ES37, ES40, ES41, ES6, PS33, PS330, PS3300TH, PS330TH, PS34, PS340, PS341, PS3410, PS344, PS350, PS390, PS400, PS401, PS41, PS45; Echo: CS2600ES, CS260TES, CS2700ES, CS3500ES, CS350WES, CS351WES; Hitachi: CS280A, CS280B, CS350A, CS350B, CS355B; Homelite: 20AV, 23AV, 27, 3300, 3335, 3350, 3550, 3800, 4500, 4550, CS40, HCS3335, HCS4041CA, PS33, RANGER, TIMBERMAN, UT10901, UT10926, UT10974; Husqvarna: 136, 137, 1400, 141, 142, 16, 1600, 23, 243, 315, 316, 318, 320, 321, 33, 333, 334, 335XPT, 338, 338XPT, 36, 41, E16, E316, E317, E321, T425; Jonsered: 2033TH, 2035, 2115, 2115EL, 2116, 2117, 2118EL, 2121, 2135, 2137, 2138, 2139; Makita: 5012, 5016, BUC122RFE, BUC250RDE, DCS230T, DCS232T, DCS300, DCS300S, CS330, DCS330S, DCS34, DCS340, DCS341, DCS3410TH, DCS350, DCS3500, DCS3501, DCS3520A, DCS380, DCS390, DCS400, DCS401, DCS4610, UC3000, UC3030A, UC3500, UC3501, UC3520A, UC3530AK, UC4000, UC4030AK; McCulloch: MS1215, MS1415, MS1425, MS1435, MS1630, MS1635AV, MS1640, MS1645, MS1834N, MS1845J; Oleo-Mac: 931, 932, GS35, GS350, GS370; Partner: 330, 335, 340, 345, 350, 351, 360, 370, 385, 391, 395, P390, P420, P842; Ryobi: APR02, PCN33351



YATO	size / rozmiar	
YT-84951	14" (36 cm)	50

for / dla: YT-849321

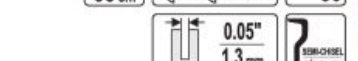
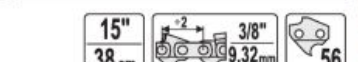

YATO	size / rozmiar	
YT-84952	15" (38 cm)	50

GB Chain for chainsaw
D Kette für Kettensägen
PL Łańcuch łańcuch do pił
RUS Цепь для бензопилы

CZ Řetěz pro řetězové pily
H Lánč lánčfűrés
RO Lant pt. drujba

F Chaîne de tronçonneuse
I Taglio per motoseghea

E Cadena de motosierra
CN 蠟沫

COLOR BOX
WITH EURO HOLE



KICKBACK REDUCTION
REDUKCIJA ODRZUTU
VIBRATION REDUCTION
REDUKCIJA WIBRACJI
Mn 65

for / dla: YT-84935

for / dla: **Al-Ko:** 2000, 2300, 25A, E1200, E125, E1400, E1500, KE3500 VARIO, KE4000, KS, KSB; **Alpina:** 352, 382, A10E, A14E, E120, E130, E150, ELECTRIC, ES182, ES202, KS1400B, KS1500B; **Dolmar:** 100, 101, 102, 103, 104, 105, 106, 108, 275, 285, CS2040, ES140, ES151, ES152, 152A, ES153, ES160, ES161, ES162, ES162A, ES163, ES172, ES172A, ES173, ES183, ES2035, ES2040, ES3, ES30, ES37, ES40, ES41, ES6, PS33, PS330, PS3300TH, PS3300TH, PS34, PS340, PS341, PS3410, PS344, PS350, PS390, PS400, PS401, PS41, PS45; **Echo:** CS2600ES, CS260TES, CS2700ES, CS3500ES, CS350WES, CS351WES; **Hitachi:** CS280A, CS280B, CS350A, CS350B, CS35B; **Homelite:** 20AV, 23AV, 27, 3300, 3335, 3350, 3550, 3800, 4500, 4550, CS40, HCS3335, HCS4041CA, PS33, RANGER, TIMBERMAN, UT10901, UT10926, UT10974; **Husqvarna:** 136, 137, 1400, 141, 142, 16, 1600, 23, 243, 315, 316, 318, 320, 321, 33, 333, 334, 335XPT, 338, 338XPT, 36, 41, E16, E316, E317, E321, T425; **Jonsered:** 2033TH, 2035, 2115, 2115EL, 2116, 2117, 2118EL, 2121, 2135, 2137, 2138, 2139; **Makita:** 5012, 5016, BU-C122RFE, BUC250RDE, DCS230T, DCS232T, DCS300, DCS300S, DCS330, DCS330S, DCS34, DCS340, DCS341, DCS3410TH, DCS350, DCS3500, DCS3501, DCS3520A, DCS380, DCS390, DCS400, DCS401, DCS4610, UC3000, UC3030A, UC3500, UC3501, UC3520A, UC3530AK, UC4000, UC4030AK; **McCulloch:** MS1215, MS1415, MS1425, MS1435, MS1630, MS1635AV, MS1640, MS1645, MS1834N, MS1845J; **Oleo-Mac:** 931, 932, GS35, GS350, GS370; **Partner:** 330, 335, 340, 345, 350, 351, 360, 370, 385, 391, 395, P390, P420, P842; **Ryobi:** APR02, PCN3335

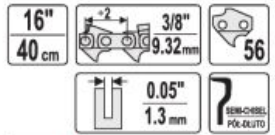

YATO	size / rozmiar	
YT-84953	16" (40 cm)	50

for / dla: YT-84935

for / dla: **Al-Ko:** 2000, 2300, 25A, E1200, E125, E1400, E1500, KE3500 VARIO, KE4000, KS, KSB; **Alpina:** 352, 382, A10E, A14E, E120, E130, E150, ELECTRIC, ES182, ES202, KS1400B, KS1500B; **Dolmar:** 100, 101, 102, 103, 104, 105, 106, 108, 275, 285, CS2040, ES140, ES151, ES152, ES152A, ES153, ES160, ES161, ES162, ES162A, ES163, ES172, ES172A, ES173, ES183, ES2035, ES2040, ES3, ES30, ES37, ES40, ES41, ES6, PS33, PS330, PS3300TH, PS3300TH, PS34, PS340, PS341, PS3410, PS344, PS350, PS390, PS400, PS401, PS41, PS45; **Echo:** CS2600ES, CS260TES, CS2700ES, CS3500ES, CS350WES, CS351WES; **Hitachi:** CS280A, CS280B, CS350A, CS350B, CS35B; **Homelite:** 20AV, 23AV, 27, 3300, 3335, 3350, 3550, 3800, 4500, 4550, CS40, HCS3335, HCS4041CA, PS33, RANGER, TIMBERMAN, UT10901, UT10926, UT10974; **Husqvarna:** 136, 137, 1400, 141, 142, 16, 1600, 23, 243, 315, 316, 318, 320, 321, 33, 333, 334, 335XPT, 338, 338XPT, 36, 41, E16, E316, E317, E321, T425; **Jonsered:** 2033TH, 2035, 2115, 2115EL, 2116, 2117, 2118EL, 2121, 2135, 2137, 2138, 2139; **Makita:** 5012, 5016, BUC122RFE, BUC250RDE, DCS230T, DCS232T, DCS300, DCS300S, DCS330, DCS330S, DCS34, DCS340, DCS341, DCS3410TH, DCS350, DCS3500, DCS3501, DCS3520A, DCS380, DCS390, DCS400, DCS401, DCS4610, UC3000, UC3030A, UC3500, UC3501, UC3520A, UC3530AK, UC4000, UC4030AK; **Oleo-Mac:** 931, 932, GS35, GS350, GS370; **Partner:** 330, 335, 340, 345, 350, 351, 370, 385, 395, P390, P420; **Ryobi:** APR02, PCN3335

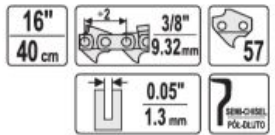

YATO	size / rozmiar	
YT-84954	16" (40 cm)	50

for / dla: **Stihl:** 029, 031, 032, 034, 036, 038, 039, 041, 042, 044, 045, 046, 048, 056, 064, 066, E15, E20, E220, MS200, MS220, MS290, MS310, MS311, MS340, MS341, MS361, MS362, MS390, MS440, MS441, MS460, MS650, MS660, MS880, MSE200, MSE220

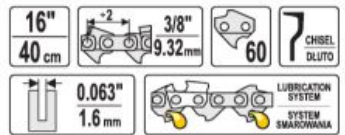

YATO	size / rozmiar	
YT-84955	16" (40 cm)	50

for / dla: YT-849355

GB Chain for chainsaw
D Kette für Kettensägen
PL Łańcuch łańcuch do pił
RUS Цепь для бензопилы
CZ Řetěz pro řetězové pily
H Lánč lánčfűrés

RO Lant pt. drujba
F Chaîne de tronçonneuse
I Taglio per motoseghea
E Cadena de motosierra
CN 蠟沫



PAPER SPOOL & COLOR LABEL PLUS 30 PCS OF ADDITIONAL COLOR BOXES & POLYBAGS



+30 PCS

KICKBACK REDUCTION
REDUKCIJA ODRZUTU
VIBRATION REDUCTION
REDUKCIJA WIBRACJI
Mn 65
30 SPARE LINKS ZAPASOWYCH OGNIV

for / dla: YT-84930, YT-84931, YT-84935

for / dla: **Alpina:** 270, 280, 330, 380, 432, 438, EURO-40, EURO-45, Elletra 160, Elletra 170, Energy 1.6, Energy 1.8, P360, P370, P390, PR350, Sinergy 35, Sinergy 40; **Dolmar:** CS2040, PS3300TH; **Husqvarna:** T425; **McCulloch:** 3500, 370, 374, 375, 384, 400, 400P, 430, 442, 445, 470, 474, 484, 838, 839, ELECTRA MAC 16E, MAC110, MAC120, MAC130, MAC140, MAC4, MAC6, MAC930, MAC935, MC115, MM30, MM36, PM310, PM320, PM330, PM340, PM36, PM360, PM364, PM370, PM380, PM394, PM400, M470, PM480, PM484, PM510, PM730; **Oleo-Mac:** 240, OEM200; **Partner:** 1535EL, 1540, 1540EL, 1640, 1835, 1840, 352, 371, 391, 538E, 542E, P1535, P351; **Stihl:** 009, 010, 011, 012, 017, 018, 019, 019T, 020, 020T, 021, 021C, 023, 025, 25, MS160, MS170, MS180, MS181, MS191, MS192, MS200, MS200T, MS210, MS211, MS230, MS231, MS241, MS250, MS251, MSE140, MSE200



YATO	size / rozmiar	
YT-84960	16" (40 cm)	1

for / dla: YT-84932

for / dla: **Alpina:** P700, P750, P800, PROF700, PROF800; **Dolmar:** 115, 117, 119, 120, 120SI, 122, 123, 1231, 133, 143, 152, 153, 186, 219, CA, KMS4, PS43, PS6000I, PS6000IH, PS6400, PS6400H, PS6800I, PS6800IH, PS7300, PS7300H, PS7900, PS7900H, PS9000, PS9010; **Echo:** CS3500, CS350WES, CS351WE; **Husqvarna:** 1100, 154, 160, 162, 181, 2100XP, 2101, 2101XP, 254, 257, 260, 261, 262, 266, 268, 272, 281XP, 285, 288XP, 298, 298X, 298XG, 3120, 3120XP, 357, 357XP, 359, 362, K34365, 371, 371XP, 371XP, 372XP, 372XP, 372XP, 380, 385, 385XP, 394, 394XP, 394XP, 395, 395XP, 395XP, 455, 480, 55, 560XP, 562XP, 570, 575, 575XP, 576XP, 61, 64, 65, 66, 70, 77; **Jonsered:** 1020, 2063, 2065, 2071, 2077, 2083, 2094, 2095, 2159, 2163, 2165, 2171, 2186, 625, 630, 630 SUPER, 670, 670 CHAMP, 820; **Makita:** DCS460, DCS4600, DCS500, DCS5030, DCS6400, DCS6401, DCS7301, DCS79001, DCS9000, DCS9010; **Oleo-Mac:** 250A, 251, 252, 254, 261, 264, 271, 272, 284, 350, 355, 460, 480, 481, 482, 484, 970, 971, 980, 981, E300; **Partner:** 550, 660, 710, P770

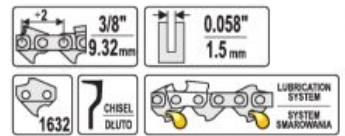

YATO	size / rozmiar	
YT-84961	16" (40 cm)	1

for / dla: YT-84905, YT-84933

for / dla: **Dolmar:** 109, 110, 111, 112, 113, 114, 115, 116, PS460, PS4600, S4605, PS500, PS5000, PS510, PS5100S, PS540; **Husqvarna:** 133, 136, 137, 141, 142, 154, 234, 238, 240, 242, 42XP, 246, 254, 254XP, 257, 261, 262, 338XPT, 339XP, 340, 345, 346, 346XP, 350, 351, 353, 357, 357XP, 359, 36, 65, 40, 41, 42, 435, 435E, 44, 440E, 444, 445, 445E, 45, 450E, 455 RANCHER, 455E RANCHER, 460, 460 RANCHER, 50, 51, 55, T435; **Jonsered:** 2012, 2014, 2015, 2016, 2036, 2040, 2041, 2045, 2050, 051, 2054, 2055, 2063, 2141, 2145, 2147, 2149, 2150, 2152, 2153, 2155, 2156, 2159, 2163, 370, 380, 410, 420, 425, 435, 45, 450, 451, 451EVS, 452, 455, 490, 49SP, 50, 51, 510, 52, 520, 521, 525, 535, 590, CS2149W, CS2152W; **Makita:** 45, DCS430, DCS43001, DCS43001, DCS431, DCS460, DCS4600S, DCS4630, DCS500, DCS5000, DCS5030, DCS520, DCS52001; **Oleo-Mac:** 850, 938, 940, 941, 941C, 942, 945, 946, 947, 950, 950 Super, 950A, 951, 952, 956, 962, E300F, GS350, GS370, GS410CX; **Partner:** 1200EL, 1400EL, 1450EL, 1500EL, 1650EL, 365, 400, 405, 410, 450, 460, 465, 470, 495, 500, 510, 540, 545, P500, P5000, P5500

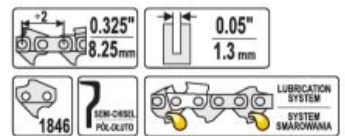

YATO	size / rozmiar	
YT-84962	16" (40 cm)	1

for / dla: YT-84900, YT-84934, YT-84936

for / dla: **Dolmar:** 109, 110, 111, 112, 113, 114, 115, 116, ES1800, PS460, PS4600, PS4605, PS500, PS5000, PS5510, PS5100S, PS540; **Husqvarna:** 154, 257, 440e, 133, 136, 137, 140, 141, 142, 234, 235, 238, 240, 240e, 242, 242XP, 246, 254, 254XP, 261, 262, 338XPT, 339XP, 340, 345, 346, 346XP, 350, 351, 353, 357, 357XP, 359, 36, 365, 372XP, 40, 41, 42, 435, 435E, 44, 444, 445, 445E, 45, 450E, 455 RANCHER, 455E RANCHER, 460 RANCHER, 50, 51, 55, T435; **Jonsered:** 520, 2012, 2014, 2015, 2016, 2036, 2040, 2041, 2045, 2050, 2051, 2054, 2055, 063, 2141, 2145, 2147, 2149, 2150, 2152, 2153, 2155, 2156, 2159, 2163, 370, 380, 410, 420, 425, 435, 45, 450, 451, 451EVS, 452, 455, 490, 49SP, 50, 51, 510, 52, 521, 525, 535, 590, DCS520, DCS52001; **NAC:** NO-C320S, SPS01-45, SPS01-52, SPS02-45, YD 40/45, YD40, YD52; **Oleo-Mac:** 850, 938, 940, 941, 942, 945, 946, 947, 950, 950 Super, 950A, 951, 952, 956, 962, E300F; **Partner:** 1650, 365, 400, 405, 410, 450, 460, 465, 470, 495, 500, 510, 540, 545, P500, P5000, P5500

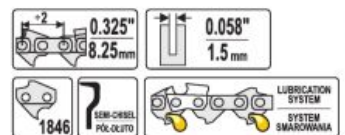

YATO	size / rozmiar	
YT-84963	16" (40 cm)	1

- GB Spare link for chainsaw
 D Ersatzglied für Kettensäge
 PL Ogniwa do łańcucha do pił
 RUS Запасная цепь
 CZ Náhradní řetěz řetězu
 H Csere lánc
 RO Nituri lant drujba
- F Lien de rechange pour tronçonneuse
 I Set di maglie di catena
 E Repuesto para sierra de cadena
 CN 连接片



POLYBAG WITH HEADER



5 PCS
Mn 65

for / dla: YT-84940, YT-84941, YT-84942, YT-84943, YT-84944, YT-84963



YATO 100
YT-84975

for / dla: YT-84945, YT-84962



YATO 100
YT-84976

for / dla: YT-84950, YT-84951, YT-84953, YT-84954, YT-84960

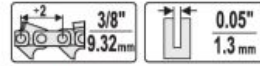

YATO 100
YT-84977

for / dla: YT-84955



YATO 100
YT-84978

- GB Chainsaw chain spinner
 D Sägekette nietgerät
 PL Nitownica do łańcuchów do pilarek
 RUS Станок для клепания цепей
 CZ Nitovačka pilových řetězů
 H Szegecselő készülék fűrészlánchoz

- RO Masina de nituit lanturi si de spart lanturi
 F Riveteuse d'établi pour chaînes de tronçonneuses
 I Catena spinner
 E Remachadora banco cadenas de motosierra
 CN 釘蠟

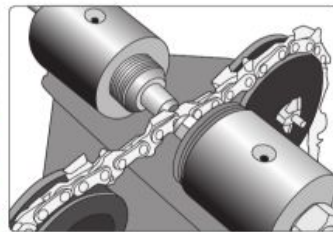

YATO 6
YT-84970

COLOR BOX

- GB Chainsaw chain breaker
 D Sägeketten Entnietgerät
 PL Rozkuwarka do łańcuchów pilarek
 RUS Станок для расклепки цепей
 CZ Roznitovačka pilových řetězů
 H Szegecskinyomó fűrészlánchoz
 RO Masina spart lant drujba
 F Deriveteuse chaîne de tronçonneuse
 I Catena breaker
 E Rompe cadenas de motosierra
 CN 釘蠟

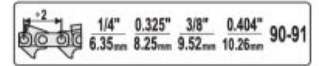

YATO 6
YT-84971

COLOR BOX

- GB Electric hoist
 D Elektro-Seilwinde
 PL Elektryczny wciągnik linowy
 RUS Электрическая канатная лебедка
 CZ Elektrický naviják kladkostroj
 H Elektromos csőrő
 RO Troliu electric cu cablu
 F Treuil électrique à corde
 I Verricello elettrico
 E Cabría eléctrica de cuerdas
 CN 电动葫芦



COLOR BOX



230V~50Hz	STOP	500W	125 kg	250 kg	8 min / max. 11m	4 min / max. 5.5m
$L_{PA} \leq 70$ dB; $L_{WA} \leq 85$ dB		YATO W				
		YT-5901	500	2		
		550W	150 kg	300 kg	8 min / max. 11m	4 min / max. 5.5m
$L_{PA} \leq 70$ dB; $L_{WA} \leq 85$ dB		YATO W				
		YT-5902	550	2		
		900W	250 kg	500 kg	8 min / max. 11m	4 min / max. 5.5m
$L_{PA} \leq 70$ dB; $L_{WA} \leq 85$ dB		YATO W				
		YT-5904	900	2		
		1050W	300 kg	600 kg	8 min / max. 11m	4 min / max. 5.5m
$L_{PA} \leq 70$ dB; $L_{WA} \leq 85$ dB		YATO W				
		YT-5905	1050	2		

Memo

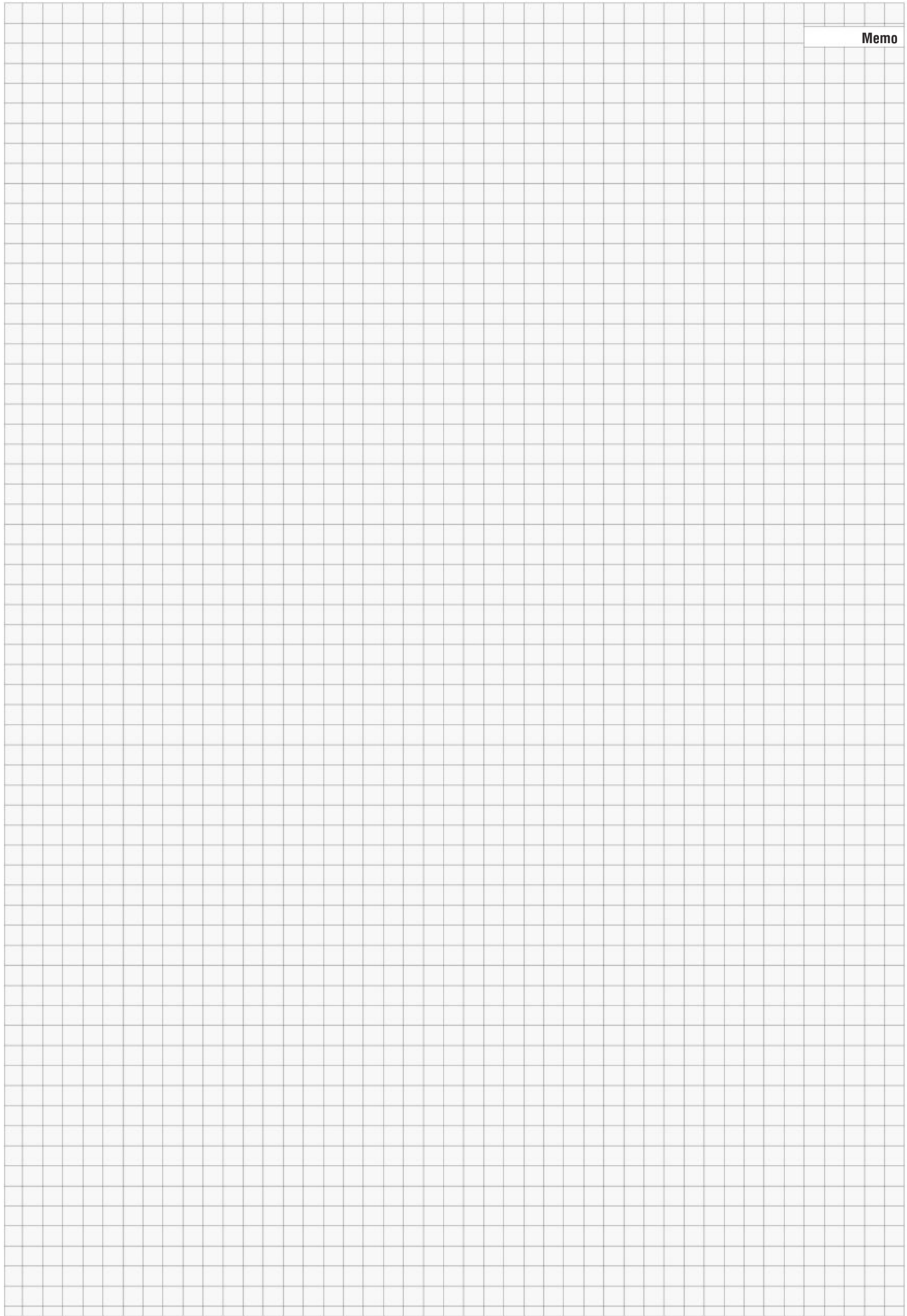

19

Accessories Akcesoria



Tool belts
Pasy na narzędzia

446-447



Tool bags
Torby narzędziowe

448-449



Tool pockets
Kieszenie na narzędzia

447-448



GB Pouch belt
 D Werkzeuggürtel
 PL Pas na kieszenie narzędziowe z uchwytem na młotek
 RUS Пояс с инструментами
 CZ Opasek s nářadím
 H Szerszám öv

RO Centura scule
 F Ceinture à outils
 I Cintura con le tasche porta utensili
 E Cinturón para herramientas
 CN 工具腰帶



600D
 POLYESTER
 POLYESTER

SET INCLUDES: WZESTAWIE:
 • pouch belt • pas na kieszenie narzędziowe
 • hammer holder • uchwyt na młotek

YATO	
YT-74003	20

GB Tool belt
 D Werkzeuggürtel
 PL Pas narzędziowy
 RUS Инструмент пояса
 CZ Opasek s nářadím
 H Szerszám öv
 RO Centura scule
 F Ceinture à outils
 I Cintura porta utensili
 E Cinturón para herramientas
 CN 工具袋



600D
 POLYESTER
 POLYESTER

SET INCLUDES: WZESTAWIE:
 • tool belt • pas narzędziowy
 • 4 large pockets • 4 duże kieszenie
 • 2 hammer holders • 2 uchwyty na młotki
 • 6 small pockets • 6 kieszonek

YATO	
YT-74001	10



SET INCLUDES: WZESTAWIE:
 • tool belt • pas narzędziowy
 • 4 big patch pockets • 4 duże nakładane kieszenie
 • measuring tape holder • uchwyt na taśmę mierniczą
 • 10 small pockets • 10 kieszonek

YATO	
YT-74002	10

GB Tooling belt with harness
 D Werkzeuggürtel mit Hosenträger
 PL Pas narzędziowy na szelkach
 RUS Инструментальный пояс с лямками

CZ Opasek na nářadí
 H Szerszám öv
 RO Curea port scule
 F Ceinture à outils avec harnais

I Cintura portautensili con bretelle
 E Cinturón para herramientas con arnés
 CN 背帶式組合工具袋

600D
 POLYESTER
 POLYESTER

DETACHABLE HARNESS
 COPORNANA UPRZĄŻ



SET INCLUDES: WZESTAWIE:
 • harness • szelki (uprząż)
 • tool bags for belt • sakwy
 • hammer holder • uchwyt na młotek
 • nails pouch • torba na gwoździec

YATO	
YT-74070	10

19



SET INCLUDES: WZESTAWIE:
 • harness • szelki (uprząż)
 • tool bag • sakwa
 • two holsters for drill or driver • dwie kabury na elektronarzędzia

YATO	
YT-74071	8

GB Heavy duty nail & tool pouch
D Werkzeuggürtel mit Nägel- und Schraubentaschen
PL Pas z kieszeniami na gwoździe i narzędzia
RUS Ремень с сумками для гвоздей и инструментов

CZ Pás na nářadí pětikapsový
H Szeg és szerszámartó öv
RO Centura port scule
F Ceinture porte-outils clous
I Cintura con le tasche per chiodi e utensili

E Cinturón porta herramientas y accesorios varios
CN 重型工具袋



21
POCKETS
KIESZENI

130
cm

HEAVY
DUTY
NYLON

COWHIDE BELT



COLOR BOX

YATO
YT-7400

10

GB Pouch belt
D Gürtel für Werkzeugtaschen
PL Pas na kieszenie na narzędzia
RUS Пояс для карманов для инструмента
CZ Opasek na monterské kapsáře
H Öv erszényhez

RO Curea cu buzunar
F Ceinture porte-outils
I Cintura con le tasche porta utensili
E Cinturón para bolsas de herramientas
CN 工具腰帶



HEADER
CARD



90-120
cm

HEAVY
DUTY
NYLON

YATO
YT-7409

50/100

GB 8-pocket tool bag
D Gürtelwerkzeugtasche mit 8 Fächern
PL 8. kieszeniowa torba na narzędzia
RUS Сумка - 8 карманов для инструмента
CZ Kapsář na nářadí 8-kapsový
H Szerszámartó erszény, 8 zsebbel
RO Geanta pt. scule 8 buzunare
F Pochette à outils
I Borsa porta attrezzi con 8 tasche
E Bolso para herramientas de 8 bolsillos
CN 工具包

HEADER
CARD



8
POCKETS
KIESZENI

HEAVY
DUTY
NYLON

GB Pocket - bag for nails and tools
D Werkzeugtasche
PL Torba na gwoździe i narzędzia
RUS Сумка для инструментов
CZ Univerzální kapsa na nářadí
H Impregnált bőr szerszám-szögtáska
RO Geanta cu buzunare pt. cuie si scule
F Multi-poché sac pour outil

I Tasca da cintura per chiodi e attrezzi
E Bolsillo para uñas y herramientass
CN 钉子袋

600D
POLYESTER
POLYESTER



YATO
YT-7410

20/40

YATO
YT-74171

24

GB Tool pouch
D Werkzeugbeutel
PL Kabura na wkrętarke lub wiertarkę
RUS Инструмент мешок
CZ Opaskové pouzdro
H Szerszám pisztolytáska
RO Suport masina de gaurit pt. centura
F Pochette d'outil
I Fondina per trapani a batteria
E Herramientas de bolsillo
CN 电钻通用挂袋

600D
POLYESTER
POLYESTER



GB Universal cordless drill holder
D Gürteltasche für Akkuschauber
PL Kieszeń na wiertarkę akumulatorową
RUS Карман для аккумуляторной дрели
CZ Kapsář za opasek na akuvrtačku
H Univerzálnis tartóerszény akkus csavabehajtóhoz

RO Suport universal pt. bormasina
F Pochette à perceuse sans fil
I Fondina per trapano a batteria
E Bolsa porta taladradora de acumulador
CN 电钻通用挂袋

HEADER
CARD



HEAVY
DUTY
NYLON



YATO
YT-74141

60

YATO
YT-7413

10/40

YATO
YT-7414

48/96

GB Nail / tool pouch
 D Gürtelwerkzeugtasche
 PL Kieszeń na gwoździe i narzędzia
 RUS Карман для гвоздей и инструментов
 CZ Kapsář na nářadí
 H Szeg és szerszámartató erszény

RO Buzunar pt. scule / cuie
 F Pochette à outils et clous
 I Tasche per chiodi e utensili
 E Bolsa porta herramientas y accesorios varios
 CN 钉子袋



YATO
 YT-7416 20/40

YATO
 YT-7417 39/156

GB Pouch for nails and tools
 D Werkzeugtasche
 PL Sakwa na gwoździe i narzędzia
 RUS Сумка для инструментов
 CZ Univerzální kapsa na nářadí
 H Impregnált bőr szerszám-szögtáska
 RO Geanta cu buzunare pt. cuie si scule
 F Multi-poche sac pour outil
 I Borsa per chiodi e attrezzi
 E Bolsillo para uñas y herramientas
 CN 电钻通用挂袋



600D
 POLYESTER
 POLYESTER
8
 POCKETS
 KIESZEN

YATO
 YT-74172 30

GB Nail pocket + hammer loop
 D Hammer und Nägel-Gürteltasche
 PL Kieszeń z uchwytem na młotek
 RUS Карман-держатель для молотка
 CZ Kapsář za opasek na kladivo
 H Szeg tartó erszény kalapácstartóval
 RO Suport pt. ciocan
 F Pochette à outils + porte-marteau
 I Tasca porta martello
 E Bolsa con el soporte para martillo
 CN 锤头钉子袋



HEAVY DUTY NYLON



GB Mobile phone pouch
 D Handy-Gürteltasche
 PL Kieszeń na telefon komórkowy
 RUS Карман для мобильного телефона
 CZ Pouzdro za opasek na mobilní telefon
 H Mobil telefon tartó
 RO Suport pt. telefon
 F Pochette à téléphone portable
 I Tasca porta cellulare
 E Bolsa de teléfono móvil
 CN 手机袋



HEAVY DUTY NYLON



YATO
 YT-7419 40/80

YATO
 YT-7420 27/54

GB Tool bag
 D Werkzeugtasche
 PL Torba na narzędzia

RUS Сумка для инструмента
 CZ Taška montérská
 H Szerszámos táská

RO Geanta pt. scule
 F Sac à outils
 I Borsa per attrezzi

E Bolso de herramientas
 CN 工具包

600D
 POLYESTER
 POLYESTER



17
 POCKETS
 KIESZEN
RUBBER BOTTOM
 GUMOWY SPÓD

YATO
 YT-74360 8



15
 POCKETS
 KIESZEN
RUBBER BOTTOM
 GUMOWY SPÓD

YATO
 YT-74361 6



41
 POCKETS
 KIESZEN

YATO
 YT-74351 4

GB Tool bag
 D Werkzeugtasche
 PL Torba na narzędzia

RUS Сумка для инструмента
 CZ Taška montérská
 H Szerszámos táská

RO Geanta pt. scule
 F Sac à outils
 I Borsa per attrezzi

E Bolso de herramientas
 CN 工具包

HEAVY DUTY NYLON



50
 POCKETS
 KIESZEN
STEEL EDGES FRAMES
EASY OPEN
EASY CLOSE

YATO
 YT-7430 12



16
 POCKETS
 KIESZEN

YATO
 YT-7433 12

GB Open tote tool bag
D Werkzeugtrage
PL Pojemnik na narzędzia

RUS Контейнер для инструментов
CZ Přeprava na nářadí
H Szerszámartó csövázás

RO Geanta de otel pt. portbagaj
F Panier porte-outils
I Borsa portautensili

E Maletin de herramientas
CN 具包

600D
POLYESTER
POLYESTER



16
POCKETS
KIESZEN

YATO
YT-74370



6



9
POCKETS
KIESZEN

YATO
YT-74371



6



17
POCKETS
KIESZEN

YATO
YT-74372



6



11
POCKETS
KIESZEN

YATO
YT-74373



6

GB Steel tube tool carrier
D Werkzeugkoffer
PL Walizka narzędziowa
RUS Семодан для инструмента
CZ Taška na nářadí
H Szerszámartó csövázás

RO Geanta de otel pt. portbagaj
F Sac à outils
I Valigetta per attrezzi
E Maletin de herramientas
CN 钢管柄工具包

31
POCKETS
KIESZEN

HEAVY
DUTY
NYLON

GB Foldable chair with bag
D Werkzeugtasche mit Klappstuhl
PL Torba narzędziowa z krzeselkiem
RUS Стул складной с сумкой
для инструмента
CZ Taška na nářadí se stojánkem
H Összecsukható szék tartózsebbel

RO Scaun rabatabil cu geanta
F Sac à outils + tabouret
I Sedia pieghevole per borsa attrezzi
E Bolso de herramientas
con silla plegable
CN 带包折叠椅

22
POCKETS
KIESZEN

HEAVY
DUTY
NYLON



10 kg



YATO
YT-7435



4



YATO
YT-7446



10

20

Health & safety articles
Artykuły BHP



Safety glasses
Okulary ochronne

452-453



Disposable dust masks
Półmaski filtrujące

456-457



Corrective protection glasses
Okulary ochronne korekcyjne

453



Ear plugs
Zatyczki do uszu

457



Safety goggles
Gogle ochronne

453



Hearing protectors
Nauszniki przeciwhałasowe

457



Working gloves
Rękawice robocze

454



Working shoes
Buty robocze

458-459



Working aprons
Fartuchy robocze

454



Safety sandals

Sandały robocze 458

Low-cut safety shoes

Półbuty robocze 458

Middle-cut safety shoes

Trzewiki robocze 459

Safety support belts
Pasy antyprzeciążeniowe

454



Working clothes

Odzież robocza

460-465



Safety harness & accessories
Szelki bezpieczeństwa i akcesoria

455



Vests

Kamizelki 460

Working jackets

Bluzy i kurtki robocze 460

Working trousers

Spodnie robocze 462

Work bib pants

Spodnie robocze ogrodniczki 463

Working overalls

Kombinezony robocze 465

Knee pads
Nakolanniki

455



GB Safety glasses
D Schutzbrille
PL Okulary ochronne

RUS Очки защитные открытые
CZ Ochranné brýle
H Védőszemüveg

RO Ochelari pt. protectie
F Lunettes de protection
I Occhiali protettivi

E Gafas protectoras
CN 劳保眼镜

PAPER
HANGING
CARD



TYPE 90960 EN 166:2001 F

YATO	
YT-7360	12/240



TYPE 9844 EN 166:2001 F

YATO	
YT-7361	12/240



TYPE 91977 EN 166:2001 F

YATO	
YT-7363	12/240



TYPE 91659 EN 166:2001 F

YATO	
YT-7365	12/240



TYPE 91708 EN 166:2001 F

YATO	
YT-7367	12/240



TYPE 91797 EN 166:2001 F

YATO	
YT-7369	12/240



TYPE 91692 EN 166:2001 F

YATO	
YT-7371	12/240



TYPE B524 EN 166:2001 F

YATO	
YT-73631	12/300



TYPE B532 EN 166:2001 F

YATO	
YT-73761	12/300



TYPE 9844 EN 166:2001 F

YATO	
YT-7362	12/240



TYPE 91977 EN 166:2001 F

YATO	
YT-7364	12/240



TYPE 91659 EN 166:2001 F

YATO	
YT-7366	12/240



TYPE 91708 EN 166:2001 F

YATO	
YT-7368	12/240



TYPE 91293 EN 166:2001 F

YATO	
YT-7374	12/240



TYPE 91380 EN 166:2001 F

YATO	
YT-7376	12/240



TYPE B517 EN 166:2001 F

YATO	
YT-73641	12/300



TYPE B532 EN 166:2001 F

YATO	
YT-73760	12/300



TYPE 92281 EN 166:2001 F

YATO	
YT-73602	12/240

GB Safety glasses
D Schutzbrille
PL Okulary ochronne

RUS Очки защитные открытые
CZ Ochranné brýle
H Védőszemüveg

RO Ochelari pt. protectie
F Lunettes de protection
I Occhiali protettivi

E Gafas protectoras
CN 劳保眼镜

POLYBAG WITH
HEADER



TYPE 92218SR EN 166:2001 F

TYPE 92281 EN 166:2001 F

TYPE 92218SR EN 166:2001 F

YATO	
YT-73700	12/240

YATO	
YT-73603	12/240

YATO	
YT-73701	12/240

GB Corrective protection glasses
with polycarbonate lenses
D Schutzbrille
PL Okulary ochronne korekcyjne
RUS Очки защитные открытые
CZ Ochranné brýle
H Védőszemüveg
RO Ochelari pt. protectie
F Lunettes de sécurité
I Occhiali da vista
di protezione
E Gafas protectoras
CN 防护眼镜



POLYBAG WITH
HEADER



BIFOCAL
ENDOGENE

TYPE 9844BI 166:2001 F

YATO	correction / korekcja	
YT-73611	+1.0 D	12/300
YT-73612	+1.5 D	12/300
YT-73613	+2.0 D	12/300
YT-73614	+2.5 D	12/300
YT-73615	+3.0 D	12/300

GB Safety goggles
with strap
D Schutzbrille
PL Gogle ochronne
z paskiem

RUS Очки защитные
CZ Ochranné brýle
H Védőszemüveg
RO Ochelari pt. protectie

F Lunettes masque
de protection
I Occhiali protettivi
con cinghia

E Gafas protectoras
CN 劳保眼镜

POLYBAG WITH
HEADER



ANTI-FOG
COATED
ODPORNE NA
ZAMGLIENIA

ANTI-SCRATCH
PROTECTION
ODPORNE NA
ZARYSIOWANIE



TYPE 92275 EN 166:2001 F

TYPE 92275 EN 166:2001 F

YATO	
YT-73765	12/240

YATO	
YT-73766	12/240

GB Safety goggles
D Schutzbrille
PL Gogle ochronne
RUS Очки защитные
CZ Ochranné brýle

H Védőszemüveg
RO Ochelari pt. protectie
F Lunettes masque
de protection

I Occhiali protettivi
a mascherina
E Gafas protectoras
CN 劳保眼镜

PAPER
HANGING
CARD



TYPE 2876 EN 166:2001 F

TYPE #2769 EN 166:2001 F

TYPE SG90B EN 166:2001 F

YATO	
YT-7377	12/120

YATO	
YT-7380	20/200

YATO	
YT-7381	20/200



TYPE SG-60 EN 166:2001 B

TYPE B608 EN 166:2001 B

TYPE B421 EN 166:2001 B

YATO	
YT-7382	10/100

YATO	
YT-73801	10/100

YATO	
YT-73830	10/100

GB Working gloves
D Arbeitshandschuh
PL Rękawice robocze
RUS Рабочие перчатки

CZ Pracovní rukavice
H Védőkesztyű
RO Mănuși de lucru

F Gants de travail
I Guanti da lavoro

E Guantes de piel
CN 劳保手套

PAPER
HEADER



NYLON
PU



YATO	size / rozmiar	
YT-7470	10	50/100

NYLON
PU



YATO	size / rozmiar	
YT-7472	10	50/100

NYLON
PU



YATO	size / rozmiar	
YT-7473	10	50/100

NYLON
NITRYLIT



YATO	size / rozmiar	
YT-7474	10	50/100

PE
NITRYLIT



YATO	size / rozmiar	
YT-7480	9	12/120
YT-7481	10	12/120

COTTON
BAWELNA

LATEX
LATEKS



YATO	size / rozmiar	
YT-7471	10	12/120

GB Elastic adjustable safety support belt
D Elastische Industriegurt
PL Pas antyprzeciążeniowy elastyczny
RUS Эластичный поддерживающий пояс с подтяжками
CZ Elastický opasek
H Rugalmas deréktámasztó öv
RO Curea de siguranță elastică ajustabilă
F Élastique de sécurité retour ceinture de soutien
I Cintura elastica di sovraccarico con bretelle staccabili
E Cinturón de soporte elástico ajustable
CN 护腰带

ELASTIC
ELASTYCZNY

DETACHABLE
SUSPENSERS
ODPINANE
SZELKI



GB High visibility elastic adjustable safety support belt
D Elastische reflektierende Industriegurt
PL Pas antyprzeciążeniowy elastyczny odblaskowy
RUS Эластичный поддерживающий пояс с высокой видимостью
CZ Reflexní elastický opasek
H Hívis rugalmas deréktámasztó öv
RO Curea de siguranță elastică reglabilă cu vizibilitate ridicată
F Élastique salut-vis de sécurité retour ceinture de soutien
I Cintura di sovraccarico ad alta visibilità
E Cinturón de soporte elástico ajustable de alta visibilidad
CN 护腰带

HOOK
FASTENER
RZEP

HIGH
VISIBILITY
WYSOKA
WIDOCZNOŚĆ



POLYBAG
WITH HEADER

YATO	size / rozmiar	
YT-74240	L	50
YT-742401	XL	50



POLYBAG
WITH HEADER

YATO	size / rozmiar	
YT-74241	XL	50
YT-742411	XXL	50

GB High visibility elastic adjustable safety support belt
D Elastische reflektierende Industriegurt
PL Pas antyprzeciążeniowy elastyczny odblaskowy
RUS Эластичный поддерживающий пояс с высокой видимостью
CZ Reflexní elastický opasek
H Hívis rugalmas deréktámasztó öv
RO Curea de siguranță elastică reglabilă cu vizibilitate ridicată
F Élastique salut-vis de sécurité retour ceinture de soutien
I Cintura di sovraccarico ad alta visibilità
E Cinturón de soporte elástico ajustable de alta visibilidad
CN 护腰带

HOOK
FASTENER
RZEP

HIGH
VISIBILITY
WYSOKA
WIDOCZNOŚĆ



POLYBAG
WITH HEADER

YATO	size / rozmiar	
YT-74242	XL	50
YT-742421	XXL	50

GB Tool apron
D Werkzeugschürze
PL Fartuch roboczy
RUS Фартук для инструментов
CZ Zástěra na nářadí
H Kertész kötény

RO Șorț pt. scule
F Outil tablier
I Grembiule da lavoro
E Delantal para herramientas
CN 围裙

6
POCKETS
MESH



POLYBAG
WITH HEADER

YATO	size / rozmiar	
YT-74060		60

- GB Safety harness for working at height
D Sicherheitsgurt für Arbeiten in Höhe
PL Szelki bezpieczeństwa z pasem biodrowym
RUS Страхочная привязь для работы на высоте
CZ Celotělový úvazek
H Biztonsági heveder
RO Centură de siguranță complexă cu suport lombar pt. munca la înălțime
F Arnès de seguridad
I Imbracatura di sicurezza con cosciale
E Harnais de sécurité
CN 高空作业安全带



100%
POLYESTER
POLYESTER

POLYBAG



YATO

YT-74220



10

- GB Safety harness for working at height
D Sicherheitsgurt für Arbeiten in Höhe
PL Szelki bezpieczeństwa
RUS Страхочная привязь для работы на высоте
CZ Celotělový úvazek
H Biztonsági heveder
RO Centură de siguranță complexă cu suport lombar pt. munca la înălțime
F Arnès de seguridad
I Imbracatura di sicurezza
E Harnais de sécurité
CN 高空作业安全带



100%
POLYESTER
POLYESTER

POLYBAG



YATO

YT-74221



20

- GB Shock absorber
D Verbindungsmittel mit Bandfalldämpfer
PL Amortyzator bezpieczeństwa
RUS Строп с амортизатором
CZ Tlumič pádu s karabinou
H Energiaelnyelő hevederszalag
RO Disipator de energie, cu cordon
F Cordes de sécurité avec amortisseur de chute
I Ammortizzatore di sicurezza
E Amortiguador de caída
CN 安全绳

100%
POLYESTER
POLYESTER



POLYBAG



YATO

YT-74227



15

- GB Steel carabiner snap hook with locking screw
D Karabiner Snap Haken Clip mit Schraube Lock
PL Karabińczyk, zatrzasknik do szelek bezpieczeństwa z nakrętką blokującą
RUS Карабин стальной
CZ Carabiná
H Karabiner
RO Carabină
F Mousqueton
I Moschettone
E Mosquetón
CN 弹簧钩

SELF CLOSING
AUTOMATYCZNE ZAMYKANIE

MANUAL LOCKING
RĘCZNE BLOKOWANIE

16 mm
WYMIAR W CIĘŻARCE

POLYBAG



YATO

YT-74229



20

- GB Gel knee pads
D Gel Knieschoner
PL Nakolanniki żelowe
RUS Гелевые наколенники
CZ Nákolenníky gelové
H Térdvédő zselés
RO Genunchiere cu protecție de silicon
F Genouillères à coussinets de gel
I Protettore per ginocchio
E Protectores de gel para rodillas
CN 护膝



TIED ON CARD



GEL SUPPORT
OCHRONA



YATO

YT-7460



12

YATO

YT-7461



12

GB Disposable dust masks
 D Atemschutzmaske
 PL Półmaski filtrujące
 jednorazowe
 RUS Респиратор
 противопылевой
 одноразовый
 CZ Protiprašná maska
 H Eldobható
 porvédőmaszk
 RO Masca praaf
 F Demi-masques
 de filtration
 I Maschera filtra polvere
 E Mascarilla desechable
 para protección
 contra polvo
 CN 防尘面罩

2
PCS FFP1 NR



YATO
 YT-74852 50

GB Disposable dust masks
 D Atemschutzmaske
 PL Półmaski filtrujące
 jednorazowe
 RUS Респиратор
 противопылевой
 одноразовый
 CZ Protiprašná maska
 H Eldobható
 porvédőmaszk
 RO Masca praaf
 F Demi-masques
 de filtration
 I Maschera filtra polvere
 E Mascarilla desechable
 para protección
 contra polvo
 CN 防尘面罩

3
PCS FFP1 NR



YATO
 YT-7485 25/100

GB Disposable dust
 mask with valve
 D Atemschutzmaske mit Ventil
 PL Półmaska filtrująca
 jednorazowa z zaworem
 RUS Респиратор
 противопылевой
 одноразовый
 с клапаном
 CZ Protiprašná maska
 s ventilem
 H Eldobható
 porvédőmaszk,
 szelepes
 RO Masca praaf cu valva
 F Demi-masques
 de filtration
 I Maschera respiratoria
 con valvola
 di espirazione
 E Mascarilla desechable
 para protección
 contra polvo
 CN 带阀防尘面罩

FFP1 NR



YATO
 YT-74862 50

GB Disposable dust
 masks with valve
 D Atemschutzmaske mit Ventil
 PL Półmaski filtrujące
 jednorazowe z zaworem
 RUS Респиратор
 противопылевой
 одноразовый с клапаном
 CZ Protiprašná maska
 s ventilem
 H Eldobható porvédőmaszk,
 szelepes
 RO Masca praaf cu valva
 F Demi-masques
 de filtration
 I Maschera respiratoria
 con valvola
 di espirazione
 E Mascarilla desechable
 para protección
 contra polvo
 CN 带阀防尘面罩

3
PCS FFP1 NR



YATO
 YT-7486 25/100

GB Disposable dust masks
 D Atemschutzmaske
 PL Półmaski filtrujące
 jednorazowe
 RUS Респиратор
 противопылевой
 одноразовый
 CZ Protiprašná maska
 H Eldobható porvédőmaszk
 RO Masca praaf
 F Demi-masques
 de filtration
 I Maschera filtra polvere
 E Mascarilla desechable
 para protección
 contra polvo
 CN 防尘面罩

3
PCS FFP1 NR



YATO
 YT-74870 50

GB Disposable dust
 masks with valve
 D Atemschutzmaske mit Ventil
 PL Półmaski filtrujące
 jednorazowe z zaworem
 RUS Респиратор
 противопылевой
 одноразовый с клапаном
 CZ Protiprašná maska
 s ventilem
 H Eldobható porvédőmaszk,
 szelepes
 RO Masca praaf cu valva
 F Demi-masques
 de filtration
 I Maschera respiratoria
 con valvola
 di espirazione
 E Mascarilla desechable
 para protección
 contra polvo
 CN 带阀防尘面罩

3
PCS FFP1 NR



YATO
 YT-7488 25/100

GB Disposable dust masks
 D Atemschutzmaske
 PL Półmaski filtrujące
 jednorazowe
 RUS Респиратор
 противопылевой
 одноразовый
 CZ Protiprašná maska
 H Eldobható porvédőmaszk
 RO Masca praaf
 F Demi-masques
 de filtration
 I Maschera filtra polvere
 E Mascarilla desechable
 para protección
 contra polvo
 CN 防尘面罩

3
PCS FFP2 NR



YATO
 YT-74916 50

GB Disposable dust
 masks with valve
 D Atemschutzmaske mit Ventil
 PL Półmaski filtrujące
 jednorazowe z zaworem
 RUS Респиратор
 противопылевой
 одноразовый с клапаном
 CZ Protiprašná maska
 s ventilem
 H Eldobható porvédőmaszk,
 szelepes
 RO Masca praaf cu valva
 F Demi-masques
 de filtration
 I Maschera respiratoria
 con valvola
 di espirazione
 E Mascarilla desechable
 para protección
 contra polvo
 CN 带阀防尘面罩

3
PCS FFP2 NR



YATO
 YT-74917 50

GB Disposable dust
 masks with valve
 D Atemschutzmaske mit Ventil
 PL Półmaski filtrujące
 jednorazowe z zaworem
 RUS Респиратор
 противопылевой
 одноразовый с клапаном
 CZ Protiprašná maska
 s ventilem
 H Eldobható
 porvédőmaszk,
 szelepes
 RO Masca praaf cu valva
 F Demi-masques
 de filtration
 I Maschera respiratoria
 con valvola
 di espirazione
 E Mascarilla desechable
 para protección
 contra polvo
 CN 带阀防尘面罩

3
PCS FFP2 NR



YATO
 YT-7492 15/60

- GB Disposable dust masks
D Atemschutzmaske
PL Półmaski filtrujące jednorazowe
RUS Респиратор противопылевой одноразовый
CZ Protiprašná maska
H Eldobható porvédőmaszk
RO Masca prař
F Demi-masques de filtration
I Maschera filtra polvere
E Mascarilla desechable para protecci3n contra polvo
CN 防尘面罩



2
PCS FFP2 NR



YATO			
YT-74919			50

- GB Disposable dust mask with valve
D Atemschutzmaske mit Ventil
PL Półmaska filtrująca jednorazowa z zaworem
RUS Респиратор противопылевой одноразовый с клапаном
CZ Protiprašná maska s ventilem
H Eldobható porvédőmaszk, szelepes
RO Masca prař cu valva
F Demi-masques de filtration
I Maschera respiratoria con valvola di espirazione
E Mascarilla desechable para protecci3n contra polvo
CN 带阀防尘面罩



FFP2 NR



YATO			
YT-74949			50

- GB Ear plugs
D Gehörschutz
PL Zatyczki do uszu
RUS Средства защиты слуха
CZ Chránice sluchu
H Fülvédőt
RO Antifoane
F Bouchons anti-bruit
I Tappi per orecchie
E Tapones para los oídos
CN 耳塞



SNR
34 dB

5
PAIRS
PAR



SNR
22 dB

5
PAIRS
PAR



YATO	size / rozmiar (mm)	pairs / pary	
YT-7451	7-12	5	25/500

YATO	size / rozmiar (mm)	pairs / pary	
YT-7455	8-12	5	25/500



SNR
34 dB

200
PAIRS
PAR



SNR
28 dB



YATO	size / rozmiar (mm)	pairs / pary	
YT-74510	7-12	200	20

YATO	size / rozmiar (mm)	pairs / pary	
YT-7456	8-12	50	20

- GB Ear plugs
D Gehörschutz
PL Zatyczki do uszu na pałaku
RUS Средства защиты слуха
CZ Chránice sluchu
H Fülvédőt
RO Antifoane
F Arceau antibruit avec bouchons
I Tappi per orecchie auricolari
E Tapones para los oídos
CN 耳塞

SNR
21 dB



YATO			
YT-7458			25/500

- GB Hearing protectors
D Gehörschutz
PL Nauszniki przeciwhałasowe
RUS Средства защиты слуха
CZ Chránice sluchu
H Fülvédőt
RO Antifoane
F Casque anti-bruit

- I Cuffie antirumore
E Protectores auditivos
CN 耳罩

POLYBAG WITH HEADER



SNR
26 dB

YATO			
YT-7462			40



SNR
26 dB

YATO			
YT-7463			20



SNR
27 dB

YATO			
YT-74621			60

GB Safety sandals
D Arbeitshalschuhe
PL Sandały robocze
RUS Полуботинки рабочие

CZ Pracovní polobotky
H Munkavédelmi félcipő
RO Bocanci de lucru
F Sandale de sécurité

I Sandalo da lavoro
E Zapato de trabajo
CN 劳保鞋

RED CARTON BOX & COLOR LABEL



INSOLE & MESH COATED EVA
WKŁADKA I WYŚCIÓŁKA Z MATERIAŁU EVA



SHOCK ABSORBER
AMORTYZATOR DRGAŃ



COMPOSITE TOE CUP
KOMPOZYTOWY NOSEK

PU OVERCUP
PODESZWA Z POLIURETANU Z NOSKIEM

YATO	size / rozmiar	
YT-80460	36	10
YT-80461	37	10
YT-80462	38	10
YT-80463	39	10
YT-80464	40	10
YT-80465	41	10
YT-80466	42	10
YT-80467	43	10
YT-80468	44	10
YT-80469	45	10
YT-80470	46	10
YT-80471	47	10

GB Low-cut safety shoes
D Arbeitshalschuhe
PL Półbuty robocze
RUS Полуботинки рабочие

CZ Pracovní polobotky
H Munkavédelmi félcipő
RO Bocanci de lucru
F Chaussure de sécurité

I Scarpe da lavoro
E Zapato de trabajo
CN 劳保鞋

RED CARTON BOX & COLOR LABEL



INSOLE & MESH COATED EVA
WKŁADKA I WYŚCIÓŁKA Z MATERIAŁU EVA



SHOCK ABSORBER
AMORTYZATOR DRGAŃ



PUNO

STALOWY NOSEK
STEEL TOE CAP
PU SOLE
PODESZWA Z POLIURETANU



INSOLE & MESH COATED EVA
WKŁADKA I WYŚCIÓŁKA Z MATERIAŁU EVA



SHOCK ABSORBER
AMORTYZATOR DRGAŃ



PARENA

STALOWY NOSEK
STEEL TOE CAP
PU SOLE
PODESZWA Z POLIURETANU



YATO	size / rozmiar	
YT-80521	39	10
YT-80522	40	10
YT-80523	41	10
YT-80524	42	10
YT-80525	43	10
YT-80526	44	10
YT-80527	45	10
YT-80528	46	10
YT-80529	47	10

YATO	size / rozmiar	
YT-80572	39	10
YT-80573	40	10
YT-80574	41	10
YT-80575	42	10
YT-80576	43	10
YT-80577	44	10
YT-80578	45	10
YT-80579	46	10
YT-80580	47	10

INSOLE & MESH COATED EVA
WKŁADKA I WYŚCIÓŁKA Z MATERIAŁU EVA



SHOCK ABSORBER
AMORTYZATOR DRGAŃ



PIURA

STEEL TOE CAP
STALOWY NOSEK
PU SOLE
PODESZWA Z POLIURETANU



INSOLE & MESH COATED EVA
WKŁADKA I WYŚCIÓŁKA Z MATERIAŁU EVA



SHOCK ABSORBER
AMORTYZATOR DRGAŃ



PUEBLE

STEEL TOE CAP
STALOWY NOSEK
PU SOLE
PODESZWA Z POLIURETANU



YATO	size / rozmiar	
YT-80552	39	10
YT-80553	40	10
YT-80554	41	10
YT-80555	42	10
YT-80556	43	10
YT-80557	44	10
YT-80558	45	10
YT-80559	46	10
YT-80560	47	10

YATO	size / rozmiar	
YT-80583	39	10
YT-80584	40	10
YT-80585	41	10
YT-80586	42	10
YT-80587	43	10
YT-80588	44	10
YT-80589	45	10
YT-80590	46	10
YT-80591	47	10

GB Middle-cut safety shoes
D Arbeitsschnürschuhe
PL Trzewiki robocze
RUS Ботинки рабочие

CZ Pracovní boty šněrovací
H Munkavédelmi bakancs
RO Pantof de lucru
F Chaussure de sécurité

I Scarpe da lavoro
E Calzado de trabajo
CN 劳保鞋

RED CARTON BOX
& COLOR LABEL



INSOLE & MESH COATED EVA

WKŁADKA I WYSIÓŁKA Z MATERIAŁU EVA



SHOCK ABSORBER
AMORTYZATOR DRGAŃ



TRAT

INSOLE & MESH COATED EVA

WKŁADKA I WYSIÓŁKA Z MATERIAŁU EVA



SHOCK ABSORBER
AMORTYZATOR DRGAŃ

STEEL TOE CAP
STALOWY NOSEK

PU SOLE
PODESZWA Z POLIURETANU



TABAR

STEEL TOE CAP
STALOWY NOSEK

PU SOLE
PODESZWA Z POLIURETANU



YATO	size / rozmiar	
YT-80733	39	10
YT-80734	40	10
YT-80735	41	10
YT-80736	42	10
YT-80737	43	10
YT-80738	44	10
YT-80739	45	10
YT-80740	46	10
YT-80741	47	10

YATO	size / rozmiar	
YT-80761	39	10
YT-80762	40	10
YT-80763	41	10
YT-80764	42	10
YT-80765	43	10
YT-80766	44	10
YT-80767	45	10
YT-80768	46	10
YT-80769	47	10

INSOLE & MESH COATED EVA

WKŁADKA I WYSIÓŁKA Z MATERIAŁU EVA



SHOCK ABSORBER
AMORTYZATOR DRGAŃ



TENDA

INSOLE & MESH COATED EVA

WKŁADKA I WYSIÓŁKA Z MATERIAŁU EVA



SHOCK ABSORBER
AMORTYZATOR DRGAŃ

STEEL TOE CAP
STALOWY NOSEK

PU OVERCUP
PODESZWA Z POLIURETANU Z NOSKIEM

PU SOLE
PODESZWA Z POLIURETANU



TEZU

STEEL TOE CAP
STALOWY NOSEK

PU SOLE
PODESZWA Z POLIURETANU



YATO	size / rozmiar	
YT-80852	39	10
YT-80853	40	10
YT-80854	41	10
YT-80855	42	10
YT-80856	43	10
YT-80857	44	10
YT-80858	45	10
YT-80859	46	10
YT-80860	47	10

YATO	size / rozmiar	
YT-80841	39	10
YT-80842	40	10
YT-80843	41	10
YT-80844	42	10
YT-80845	43	10
YT-80846	44	10
YT-80847	45	10
YT-80848	46	10
YT-80849	47	10

INSOLE & MESH COATED EVA

WKŁADKA I WYSIÓŁKA Z MATERIAŁU EVA



SHOCK ABSORBER
AMORTYZATOR DRGAŃ



TOLU

INSOLE & MESH COATED EVA

WKŁADKA I WYSIÓŁKA Z MATERIAŁU EVA



SHOCK ABSORBER
AMORTYZATOR DRGAŃ

STEEL TOE CAP
STALOWY NOSEK

PU SOLE
PODESZWA Z POLIURETANU



TWER

STEEL TOE CAP
STALOWY NOSEK

PU SOLE
PODESZWA Z POLIURETANU



YATO	size / rozmiar	
YT-80794	39	10
YT-80795	40	10
YT-80796	41	10
YT-80797	42	10
YT-80798	43	10
YT-80799	44	10
YT-80800	45	10
YT-80801	46	10
YT-80802	47	10

YATO	size / rozmiar	
YT-80783	39	10
YT-80784	40	10
YT-80785	41	10
YT-80786	42	10
YT-80787	43	10
YT-80788	44	10
YT-80789	45	10
YT-80790	46	10
YT-80791	47	10

- GB Insulated vest
- D Gepolsterte Weste
- PL Bezrękawnik ocieplany
- RUS Утепленный жилет
- CZ Vesta
- H Bélelt mellény
- RO Vestă vătuită
- F Gilet matelassé
- I Gilet imbottito
- E Chaleco acolchado
- CN 绝缘背心



100% POLYESTER
PVC COATED
100% POLYESTER
POWRODKA PVC

POLYBAG



YATO	size / rozmiar	
YT-80355	S	20
YT-80356	M	20
YT-80357	L	20
YT-80358	XL	20
YT-80359	XXL	20

DUGO

- GB Fleece jacket
- D Fleece-Jacke
- PL Bluza polarowa
- RUS Флисовая кофта
- CZ Fleecová bunda
- H Fleece dzseki
- RO Bluză polar
- F Veste polaire
- I Giacca in pile
- E Chaqueta polar
- CN 摇粒绒夹克



POLAR
350g/m²

POLYBAG



YATO	size / rozmiar	
YT-80360	S	12
YT-80361	M	12
YT-80362	L	12
YT-80363	XL	12
YT-80364	XXL	12

DURANGO BLACK

- GB Fleece jacket
- D Fleece-Jacke
- PL Bluza polarowa
- RUS Флисовая кофта
- CZ Fleecová bunda
- H Fleece dzseki
- RO Bluză polar
- F Veste polaire
- I Giacca in pile
- E Chaqueta polar
- CN 摇粒绒夹克



POLAR
350g/m²

POLYBAG



YATO	size / rozmiar	
YT-80365	S	8
YT-80366	M	8
YT-80367	L	8
YT-80368	XL	8

DURANGO GREY

- GB Softshell jacket
- D Softshell-Jacke
- PL Kurtka softshell
- RUS Softshell куртка
- CZ Softshellová bunda
- H Softshell dzseki
- RO Jacheta softshell
- F Veste softshell
- I Giacca softshell
- E Chaqueta softshell
- CN 冲锋夹克



95% POLYESTER
4% SPANDEX
1% POLYESTER
4% SPANDEX

POLYBAG



YATO	size / rozmiar	
YT-80390	S	10
YT-80391	M	10
YT-80392	L	10
YT-80393	XL	10
YT-80394	XXL	10

DEZ

- GB Working jacket
- D Arbeitsjacke
- PL Bluza robocza
- RUS Рабочая рубашка
- CZ Pracovní blůza
- H Munkaruha felső
- RO Bluză de lucru
- F Blouson de travail
- I Felpa da lavoro
- E Blusa de trabajo
- CN 工作服

95% POLYESTER
3% COTTON
1% POLYESTER
3% BAWELINA



POLYBAG
WITH PLASTIC
HANGER



YATO	size / rozmiar	
YT-80280	S	10
YT-80281	M	10
YT-80282	L	10
YT-80283	XL	10
YT-80284	XXL	10

DAN

- GB Working jacket
- D Arbeitsjacke
- PL Bluza robocza
- RUS Рабочая рубашка
- CZ Pracovní blůza
- H Munkaruha felső
- RO Bluză de lucru
- F Blouson de travail
- I Felpa da lavoro
- E Blusa de trabajo
- CN 工劳保夹克

95% POLYESTER
3% COTTON
1% POLYESTER
3% BAWELINA



POLYBAG
WITH PLASTIC
HANGER



YATO	size / rozmiar	
YT-80435	S	20
YT-80436	M	20
YT-80437	L	20
YT-80438	XL	20
YT-80439	XXL	20

DOHAR

- GB Jacket
- D Jacke
- PL Kurtka
- RUS Куртка
- CZ Bunda
- H Dzseki
- RO Jacheta
- F Veste
- I Giacca
- E Chaqueta
- CN 夹克



100% POLYESTER
PVC COATED
100% POLYESTER
POWLONA/PVC

POLAR
220g/m²

3in1
3w1

POLYBAG



YATO	size / rozmiar	
YT-80380	S	10
YT-80381	M	10
YT-80382	L	10
YT-80383	XL	10
YT-80384	XXL	10

DORRA

- GB Working jacket
- D Arbeitsjacke
- PL Bluza robocza
- RUS Рабочая рубашка
- CZ Pracovní blůza
- H Munkaruha felső
- RO Bluză de lucru
- F Blouson de travail
- I Felpa da lavoro
- E Blusa de trabajo
- CN 工作服



60% POLYESTER
30% COTTON
60% POLYESTER
30% BAWELINA

POLYBAG



YATO	size / rozmiar	
YT-8020	S	20
YT-8021	M	20
YT-8022	L	20
YT-8023	XL	20
YT-8024	XXL	20

DUERO

- GB Working jacket
- D Arbeitsjacke
- PL Bluza robocza
- RUS Рабочая рубашка

- CZ Pracovní blůza
- H Munkaruha felső
- RO Bluză de lucru
- F Blouson de travail

- I Felpa da lavoro
- E Blusa de trabajo
- CN 劳保夹克

60% POLYESTER
30% COTTON
60% POLYESTER
30% BAWELINA



POLYBAG WITH
PLASTIC HANGER



YATO	size / rozmiar	
YT-80140	S	10
YT-80141	M	10
YT-80142	L	10
YT-80143	L/XL	10
YT-80144	XL	10
YT-80145	XXL	10

- GB Working jacket
- D Arbeitsjacke
- PL Bluza robocza
- RUS Рабочая рубашка

- CZ Pracovní blůza
- H Munkaruha felső
- RO Bluză de lucru
- F Blouson de travail

- I Felpa da lavoro
- E Blusa de trabajo
- CN 劳保夹克

100% COTTON
100% BAWELINA



POLYBAG WITH
PLASTIC HANGER



YATO	size / rozmiar	
YT-80158	S	10
YT-80159	M	10
YT-80160	L	10
YT-80161	L/XL	10
YT-80162	XL	10
YT-80163	XXL	10

- GB Working jacket
- D Arbeitsjacke
- PL Bluza robocza
- RUS Рабочая рубашка
- CZ Pracovní blůza

- H Munkaruha felső
- RO Bluză de lucru
- F Blouson de travail

- I Felpa da lavoro
- E Blusa de trabajo
- CN 劳保夹克

60% POLYESTER
30% COTTON
60% POLYESTER
30% BAWELINA



POLYBAG WITH
PLASTIC HANGER



YATO	size / rozmiar	
YT-80176	S	10
YT-80177	M	10
YT-80178	L	10
YT-80179	L/XL	10
YT-80180	XL	10
YT-80181	XXL	10

- GB Working jacket
- D Arbeitsjacke
- PL Bluza robocza
- RUS Рабочая рубашка
- CZ Pracovní blůza

- H Munkaruha felső
- RO Bluză de lucru
- F Blouson de travail

- I Felpa da lavoro
- E Blusa de trabajo
- CN 劳保夹克

60% POLYESTER
30% COTTON
60% POLYESTER
30% BAWELINA



POLYBAG WITH
PLASTIC HANGER



YATO	size / rozmiar	
YT-80395	S	10
YT-80396	M	10
YT-80397	L	10
YT-80398	L/XL	10
YT-80399	XL	10
YT-80400	XXL	10

GB Working jacket
D Arbeitsjacke
PL Bluzà robocza
RUS Рабочая рубашка
CZ Pracovní blůza

H Munkaruha felső
RO Bluză de lucru
F Blouson de travail
I Felpa da lavoro
E Blusa de trabajo
CN 劳保夹克

80% POLYESTER
20% COTTON
80% POLYESTER
20% BAWELNA



POLYBAG
WITH PLASTIC
HANGER



YATO	size / rozmiar	
YT-80900	S	10
YT-80901	M	10
YT-80902	L	10
YT-80903	L/XL	10
YT-80904	XL	10
YT-80905	XXL	10

GB Working shorts
D Kurze Arbeitshosen
PL Spodnie robocze krótkie
RUS Рабочие шорты
CZ Pracovní šortky
H Munkaruha rövid nadrág
RO Pantaloni scurți de lucru
F Pantalon de travail court
I Pantaloni da lavoro corti
E Pantalones cortos de trabajo
CN 工装短裤

80% POLYESTER
20% COTTON
80% POLYESTER
20% BAWELNA



POLYBAG WITH PLASTIC HANGER



YATO	size / rozmiar	
YT-80924	S	10
YT-80925	M	10
YT-80926	L	10
YT-80927	L/XL	10
YT-80928	XL	10
YT-80929	XXL	10

GB Working shorts
D Kurze Arbeitshosen
PL Spodnie robocze krótkie
RUS Рабочие шорты
CZ Pracovní šortky
H Munkaruha rövid nadrág
RO Pantaloni scurți de lucru
F Pantalon de travail court
I Pantaloni da lavoro corti
E Pantalones cortos de trabajo
CN 工装短裤

POLYBAG WITH PLASTIC HANGER



100% COTTON
100% BAWELNA



YATO	size / rozmiar	
YT-80930	S	10
YT-80931	M	10
YT-80932	L	10
YT-80933	L/XL	10
YT-80934	XL	10
YT-80935	XXL	10

GB Working shorts
D Kurze Arbeitshosen
PL Spodnie robocze krótkie
RUS Рабочие шорты
CZ Pracovní šortky
H Munkaruha rövid nadrág
RO Pantaloni scurți de lucru
F Pantalon de travail court
I Pantaloni da lavoro corti
E Pantalones cortos de trabajo
CN 工装短裤

POLYBAG WITH PLASTIC HANGER



100% COTTON
100% BAWELNA



YATO	size / rozmiar	
YT-80936	S	10
YT-80937	M	10
YT-80938	L	10
YT-80939	L/XL	10
YT-80940	XL	10
YT-80941	XXL	10

GB Working cropped pants
D 3/4 Arbeitshosen
PL Spodnie robocze rybaczki
RUS Рабочие брюки капри
CZ Tříčtvrteční pracovní kalhoty
H Munkaruha halász nadrág
RO Pantaloni pescar de lucru
F Pantalon de travail trois-quarts
I Pantaloni da lavoro a tre quarti
E Pantalones de trabajo de tres cuartos
CN 工装中裤

POLYBAG WITH PLASTIC HANGER



80% POLYESTER
20% COTTON
80% POLYESTER
20% BAWELNA



YATO	size / rozmiar	
YT-80942	S	10
YT-80943	M	10
YT-80944	L	10
YT-80945	L/XL	10
YT-80946	XL	10
YT-80947	XXL	10

GB Working trousers
D Arbeitshosen
PL Spodnie robocze
RUS Рабочие брюки
CZ Pracovní kalhoty
H Munkaruha nadrág
RO Pantaloni de lucru
F Pantalon de travail
I Pantalone da lavoro
E Pantalón de trabajo
CN 工作服



80% POLYESTER
20% COTTON
80% POLYESTER
20% BAWELNA

POLYBAG



YATO	size / rozmiar	
YT-8025	S	20
YT-8026	M	20
YT-8027	L	20
YT-8028	XL	20
YT-8029	XXL	20

GB Working trousers
D Arbeitshosen
PL Spodnie robocze
RUS Рабочие брюки
CZ Pracovní kalhoty
H Munkaruha nadrág
RO Pantaloni de lucru

F Pantalon de travail
I Pantalone da lavoro
E Pantalón de trabajo
CN 工作服

80% POLYESTER
20% COTTON
80% POLYESTER
20% BAWELNA



DAN



POLYBAG WITH PLASTIC HANGER



YATO	size / rozmiar	
YT-80285	S	10
YT-80286	M	10
YT-80287	L	10
YT-80288	XL	10
YT-80289	XXL	10

DUERO

GB Working trousers
D Arbeitshosen
PL Spodnie robocze
RUS Рабочие брюки
CZ Pracovní kalhoty
H Munkaruha nadrág
RO Pantaloni de lucru
F Pantalon de travail
I Pantalone da lavoro
E Pantalón de trabajo
CN 工作服



85% POLYESTER
35% COTTON
65% POLYESTER
35% BAWELINA

POLYBAG
WITH
PLASTIC
HANGER



YATO	size / rozmiar	
YT-80146	S	10
YT-80147	M	10
YT-80148	L	10
YT-80149	L/XL	10
YT-80150	XL	10
YT-80151	XXL	10

GB Working trousers
D Arbeitshosen
PL Spodnie robocze
RUS Рабочие брюки
CZ Pracovní kalhoty
H Munkaruha nadrág
RO Pantaloni de lucru
F Pantalon de travail
I Pantalone da lavoro
E Pantalón de trabajo
CN 工作服



100% COTTON
100% BAWELINA

POLYBAG
WITH
PLASTIC
HANGER



YATO	size / rozmiar	
YT-80164	S	10
YT-80165	M	10
YT-80166	L	10
YT-80167	L/XL	10
YT-80168	XL	10
YT-80169	XXL	10

GB Working trousers
D Arbeitshosen
PL Spodnie robocze
RUS Рабочие брюки
CZ Pracovní kalhoty
H Munkaruha nadrág
RO Pantaloni de lucru
F Pantalon de travail
I Pantalone da lavoro
E Pantalón de trabajo
CN 工作服



85% POLYESTER
35% COTTON
65% POLYESTER
35% BAWELINA

POLYBAG
WITH
PLASTIC
HANGER



YATO	size / rozmiar	
YT-80182	S	10
YT-80183	M	10
YT-80184	L	10
YT-80185	L/XL	10
YT-80186	XL	10
YT-80187	XXL	10

GB Working trousers
D Arbeitshosen
PL Spodnie robocze
RUS Рабочие брюки
CZ Pracovní kalhoty
H Munkaruha nadrág
RO Pantaloni de lucru
F Pantalon de travail
I Pantalone da lavoro
E Pantalón de trabajo
CN 工作服



85% POLYESTER
35% COTTON
65% POLYESTER
35% BAWELINA

POLYBAG
WITH
PLASTIC
HANGER



YATO	size / rozmiar	
YT-80401	S	10
YT-80402	M	10
YT-80403	L	10
YT-80404	L/XL	10
YT-80405	XL	10
YT-80406	XXL	10

GB Working trousers
D Arbeitshosen
PL Spodnie robocze
RUS Рабочие брюки
CZ Pracovní kalhoty
H Munkaruha nadrág
RO Pantaloni de lucru
F Pantalon de travail
I Pantalone da lavoro
E Pantalón de trabajo
CN 工作服



85% POLYESTER
35% COTTON
65% POLYESTER
35% BAWELINA

POLYBAG
WITH
PLASTIC
HANGER



YATO	size / rozmiar	
YT-80906	S	10
YT-80907	M	10
YT-80908	L	10
YT-80909	L/XL	10
YT-80910	XL	10
YT-80911	XXL	10

GB Work bib pants
D Arbeitshosen, Gärtnerin
PL Spodnie robocze ogrodniczki
RUS Рабочий полукombineзон
CZ Pracovní kalhoty lačlové
H Kertész nadrág
RO Pantaloni de lucru grădină
F Salopette de travail
I Salopette da lavoro
E Pantalón de trabajo tipo jardinero
CN 背带裤



85% POLYESTER
35% COTTON
65% POLYESTER
35% BAWELINA

POLYBAG



YATO	size / rozmiar	
YT-8030	S	20
YT-8031	M	20
YT-8032	L	20
YT-8033	XL	20
YT-8034	XXL	20

DUERO

GB Work bib pants
D Arbeitshosen, Gärtnerin
PL Spodnie robocze ogrodniczk
RUS Рабочий полукомбинезон
CZ Pracovní kalhoty laclové
H Kertész nadrág
RO Pantaloni de lucru grădină

F Salopette de travail
I Salopette da lavoro
E Pantalón de trabajo tipo jardinero
CN 背带裤

85% POLYESTER
15% COTTON
85% POLYESTER
15% BAWELINA

GB Work bib pants
D Arbeitshosen, Gärtnerin
PL Spodnie robocze ogrodniczk
RUS Рабочий полукомбинезон
CZ Pracovní kalhoty laclové
H Kertész nadrág

RO Pantaloni de lucru grădină
F Salopette de travail
I Salopette da lavoro
E Pantalón de trabajo tipo jardinero
CN 背带裤

85% POLYESTER
15% COTTON
85% POLYESTER
15% BAWELINA



POLYBAG WITH PLASTIC HANGER



DAN

YATO	size / rozmiar	
YT-80290	S	10
YT-80291	M	10
YT-80292	L	10
YT-80293	XL	10
YT-80294	XXL	10



POLYBAG WITH PLASTIC HANGER



YATO	size / rozmiar	
YT-80152	S	10
YT-80153	M	10
YT-80154	L	10
YT-80155	L/XL	10
YT-80156	XL	10
YT-80157	XXL	10

GB Work bib pants
D Arbeitshosen, Gärtnerin
PL Spodnie robocze ogrodniczk
RUS Рабочий полукомбинезон
CZ Pracovní kalhoty laclové
H Kertész nadrág

RO Pantaloni de lucru grădină
F Salopette de travail
I Salopette da lavoro
E Pantalón de trabajo tipo jardinero
CN 背带裤

100% COTTON
100% BAWELINA

GB Work bib pants
D Arbeitshosen, Gärtnerin
PL Spodnie robocze ogrodniczk
RUS Рабочий полукомбинезон
CZ Pracovní kalhoty laclové
H Kertész nadrág

RO Pantaloni de lucru grădină
F Salopette de travail
I Salopette da lavoro
E Pantalón de trabajo tipo jardinero
CN 背带裤

85% POLYESTER
15% COTTON
85% POLYESTER
15% BAWELINA



POLYBAG WITH PLASTIC HANGER



YATO	size / rozmiar	
YT-80170	S	10
YT-80171	M	10
YT-80172	L	10
YT-80173	L/XL	10
YT-80174	XL	10
YT-80175	XXL	10



POLYBAG WITH PLASTIC HANGER



YATO	size / rozmiar	
YT-80188	S	10
YT-80189	M	10
YT-80190	L	10
YT-80191	L/XL	10
YT-80192	XL	10
YT-80193	XXL	10

GB Work bib pants
D Arbeitshosen, Gärtnerin
PL Spodnie robocze ogrodniczk
RUS Рабочий полукомбинезон
CZ Pracovní kalhoty lačlové
H Kertész nadrág

RO Pantaloni de lucru grădină
F Salopette de travail
I Salopette da lavoro
E Pantalón de trabajo tipo jardinero
CN 背带裤

60% POLYESTER
30% COTTON
10% POLYESTER
30% BAWELINA

GB Work bib pants
D Arbeitshosen, Gärtnerin
PL Spodnie robocze ogrodniczk
RUS Рабочий полукомбинезон
CZ Pracovní kalhoty lačlové
H Kertész nadrág

RO Pantaloni de lucru grădină
F Salopette de travail
I Salopette da lavoro
E Pantalón de trabajo tipo jardinero
CN 背带裤

60% POLYESTER
30% COTTON
10% POLYESTER
30% BAWELINA

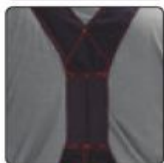

POLYBAG WITH PLASTIC HANGER



YATO	size / rozmiar	
YT-80407	S	10
YT-80408	M	10
YT-80409	L	10
YT-80410	L/XL	10
YT-80411	XL	10
YT-80412	XXL	10



POLYBAG WITH PLASTIC HANGER



YATO	size / rozmiar	
YT-80912	S	10
YT-80913	M	10
YT-80914	L	10
YT-80915	L/XL	10
YT-80916	XL	10
YT-80917	XXL	10

GB Working overall
D Arbeitsoverall
PL Kombinezon roboczy
RUS Комбинезон рабочий
CZ Pracovní kombinéza
H Overall

RO Combinezon de lucru
F Combinaison de travail
I Tuta da lavoro
E Mono de trabajo
CN 连体工作服

60% POLYESTER
30% COTTON
10% POLYESTER
30% BAWELINA

GB Working overall
D Arbeitsoverall
PL Kombinezon roboczy
RUS Комбинезон рабочий
CZ Pracovní kombinéza
H Overall

RO Combinezon de lucru
F Combinaison de travail
I Tuta da lavoro
E Mono de trabajo
CN 连体工作服

60% POLYESTER
30% COTTON
10% POLYESTER
30% BAWELINA



POLYBAG WITH PLASTIC HANGER



YATO	size / rozmiar	
YT-80194	S	10
YT-80195	M	10
YT-80196	L	10
YT-80197	L/XL	10
YT-80198	XL	10
YT-80199	XXL	10



POLYBAG WITH PLASTIC HANGER



YATO	size / rozmiar	
YT-80918	S	10
YT-80919	M	10
YT-80920	L	10
YT-80921	L/XL	10
YT-80922	XL	10
YT-80923	XXL	10

21

Electric products Artykuły elektryczne



Ceiling & wall lamps
Oprawy sufitowe i ściennie

468-471



Workshop lightning
Oświetlenie warsztatowe

475-480



Floodlights
Naświetlacze

471-474



Flashlights
Latarki

480-481



Solar lamps
Oprawy solarne

474-475



Extension cords
Przedłużacze elektryczne

482



- GB LED ceiling light
- D LED-Deckenleuchte
- PL Oprawa sufitowa LED
- RUS Потолочный светодиодный светильник
- CZ Stropní LED svítidlo
- H Mennyezeti LED lámpatest
- RO Corp de iluminat pt. tavan LED
- F Lumiere de plafond a LED
- I Plafoniera LED
- E Luz de techo del LED
- CN LED 吸顶灯



GREY CARTON BOX & COLOR LABEL



220-240V-50/60Hz

40W

216 LED

4000 lm

4000K

120°

Ra>80

YATO	W	lm	size / rozmiar (mm)	
YT-81948	40	4000	595 x 595	5

- GB LED ceiling light
- D LED-Deckenleuchte
- PL Oprawa sufitowa LED
- RUS Потолочный светодиодный светильник
- CZ Stropní LED svítidlo
- H Mennyezeti LED lámpatest
- RO Corp de iluminat pt. tavan LED
- F Lumiere de plafond a LED
- I Plafoniera LED
- E Luz de techo del LED
- CN LED 吸顶灯



GREY CARTON BOX & COLOR LABEL



230V~50Hz

4000K

120°

50000 h

IP20



40W

112 LED

3100 lm

YATO	W	lm	size / rozmiar (mm)	
YT-81943	40	3100	595 x 595 x 15	5

40W

112 LED

3000 lm

YATO	W	lm	size / rozmiar (mm)	
YT-81947	40	3000	300 x 1200 x 15	4

18W

80 LED

1150 lm

YATO	W	lm	size / rozmiar (mm)	
YT-81941	18	1150	300 x 300 x 15	10

- GB Mounting brackets for plaster-board ceiling
- D Montagehalterungen für Gipskartondecke
- PL Zestaw uchwytyw do płyt kartonowo-gipsowych
- RUS Монтажные кронштейны для потолочных светильников
- CZ Montážní konzoly na sádkarton strop
- H Rögzítőelemek mert gipszkarton mennyezet

- RO Maner pt. multi-caseta gips
- F Supports de montage pour plafonds en plâtre
- I Set di attacchi per lastre in cartongesso
- E Soportes de montaje para techo de escayola
- CN 吸顶灯安装支架



POLYBAG



YATO		
YT-81951		20

- GB Hanging wires set for suspended fittings
- D Stahlseilauflhängung für Lampen
- PL Oprawa sufitowa LED
- RUS Zestaw linek do zawieszania opraw
- CZ Kit závěsných lanek pro zavěšení světla
- H Lámpa függesztődrot
- RO Set de fire pt. montaj suspendate
- F Ensemble de suspension pour luminaires
- I Set di fili per appendere apparecchi a sospensione
- E Suspensiones con cable para lámparas
- CN 吸顶灯安装五金件

POLYBAG



YATO		
YT-81952		200

GB Waterproof lamp LED
D Wasserdichte lampe LED
PL Oprawa hermetyczna LED
RUS Светильник светодиодный герметичный
CZ Vodotěsné a prachotěsné svítidlo LED
H Vízálló lámpa LED

RO Lampa LED impermeabilă
F Plafonnier LED étanche
I Plafoniera stagna LED
E Lámpara hermética LED
CN 三防灯

GREY CARTON BOX
& COLOR
LABEL



SMD
LED



20W **1800**
lm

YATO	W	lm	size / rozmiar (mm)	
YT-81960	20	1800	600x80	12



40W **3600**
lm

YATO	W	lm	size / rozmiar (mm)	
YT-81961	40	3600	1200x80	8



50W **4500**
lm

YATO	W	lm	size / rozmiar (mm)	
YT-81962	50	4500	1500x80	8

GB Wall lamp
D Wandleuchte
PL Lampa ścienna
RUS Светильник настенный
CZ Nástěnné svítidlo
H Fali lámpa
RO Lampă de perete
F Applique
I Lampada da parete
E Lámpara de pared
CN 壁灯

COLOR
BOX



SMD
LED

15W **230V~50Hz** **850** **4000K** **120°** **IP54**
lm



OUTDOOR LAMP
LAMPĂ ZEWNĘTRZNA

YATO	W	lm	size / rozmiar (mm)	
YT-81840	15	850	260	12



OUTDOOR LAMP
LAMPĂ ZEWNĘTRZNA

YATO	W	lm	size / rozmiar (mm)	
YT-81841	15	850	260	12



OUTDOOR LAMP
LAMPĂ ZEWNĘTRZNA

YATO	W	lm	size / rozmiar (mm)	
YT-81842	15	850	285 x 170	12



OUTDOOR LAMP
LAMPĂ ZEWNĘTRZNA

YATO	W	lm	size / rozmiar (mm)	
YT-81843	15	850	285 x 170	12

GB Wall lamp
 D Wandleuchte
 PL Lampa naścienna
 RUS Светильник настенный

CZ Nástěnné svítidlo
 H Fali lámpa
 RO Lampă de perete
 F Applique

I Lampada da parete
 E Lámpara de pared
 CN 壁灯

COLOR BOX



220-240V-50/60Hz

120°

IP20



12W

840 lm

3000 K



12W

840 lm

4000 K



18W

1260 lm

3000 K

YATO	W	lm	size / rozmiar (mm)	
YT-81844	12	840	290	10

YATO	W	lm	size / rozmiar (mm)	
YT-81845	12	840	290	10

YATO	W	lm	size / rozmiar (mm)	
YT-81846	18	1260	330	10



18W

1260 lm

4000 K



24W

1680 lm

3000 K



24W

1680 lm

4000 K

YATO	W	lm	size / rozmiar (mm)	
YT-81847	18	1260	330	10

YATO	W	lm	size / rozmiar (mm)	
YT-81848	24	1680	385	5

YATO	W	lm	size / rozmiar (mm)	
YT-81849	24	1680	385	5

GB Wall lamp
 D Wandleuchte
 PL Lampa naścienna
 RUS Светильник настенный
 CZ Nástěnné svítidlo
 H Fali lámpa

RO Lampă de perete
 F Applique
 I Lampada da parete
 E Lámpara de pared
 CN 壁灯

COLOR BOX



230V~50Hz

4000 K

120°

20000 h

IP54



8W

650 lm

55 W REPLACEMENT EQUIVALENT

12W

860 lm

70 W REPLACEMENT EQUIVALENT



YATO	W	lm	size / rozmiar (mm)	
YT-81834	8	650	165 x 115	24

YATO	W	lm	size / rozmiar (mm)	
YT-81835	12	860	222 x 143	12

GB Wall lamp
D Wandleuchte
PL Lampa naścienna
RUS Светильник
настенный
CZ Nástěnné svítidlo
H Fali lámpa
RO Lampă de perete
F Applique
I Lampada da parete
E Lámpara de pared
CN 壁灯



GU10
1 x 35W max.
OUTDOOR LAMP
LAMPA ZEWNĘTRZNA

YATO	
YT-81900	20

COLOR
BOX



220-240V-
50Hz

IP44



GU10
1 x 35W max.
OUTDOOR LAMP
LAMPA ZEWNĘTRZNA

YATO	
YT-81901	20



GU10
2 x 35W max.
OUTDOOR LAMP
LAMPA ZEWNĘTRZNA

YATO	
YT-81902	12



GU10
2 x 35W max.
OUTDOOR LAMP
LAMPA ZEWNĘTRZNA

YATO	
YT-81903	12



GU10
2 x 35W max.
OUTDOOR LAMP
LAMPA ZEWNĘTRZNA

YATO	
YT-81904	12

GB Garden light with spike
D Gartenleuchte mit Erdspiess
PL Reflektor ogrodowy ze szpiculem
RUS Светильник садовый
CZ Zahradní svítidlo
H Kerti tűske fényvető
RO Lampă gradina cu pivot
F Lampe de jardin
I Lampada da giardino
con punta
E Reflector de jardin
CN 地插灯

220-240V-
50Hz

GU10
35W max.

AI

IP54



OUTDOOR LAMP
LAMPA ZEWNĘTRZNA



YATO	
YT-81775	8

COLOR
BOX



GB LED lamp
D Diodenscheinwerfer
PL Reflektor diodowy
RUS Светодиодный
прожектор
CZ LED reflektor
H Diódás reflektor
RO Reflector diodă
F Projecteur LED
I Faretto LED
E Reflector de diodos
CN 工作灯

10W 700
lm 6000 K 230V-
50Hz

20000 h IP65

COB
LED



COLOR
BOX



YATO	
YT-81800	18

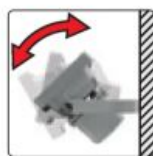

GB LED lamp
D Diodenscheinwerfer
PL Reflektor diodowy
RUS Светодиодный
прожектор
CZ LED reflektor
H Diódás reflektor
RO Reflector diodă
F Projecteur LED
I Faretto LED
E Reflector de diodos
CN 工作灯

20W 1400
lm 6000 K 230V-
50Hz

20000 h IP65

COB
LED



COLOR
BOX



YATO	
YT-81797	16

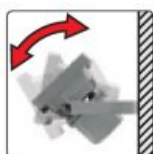

GB LED lamp
 D Diodenscheinwerfer
 PL Reflektor diodowy
 RUS Светодиодный прожектор
 CZ LED reflektor
 H Diódás reflektor
 RO Reflector diodă
 F Projecteur LED
 I Faretto LED
 E Reflector de diodos
 CN 工作灯

30W 2100 lm 6000 K 230V~50Hz
 20000 h IP65
COB LED



COLOR BOX



YATO
YT-81803 6

50W 3500 lm 6000 K 230V~50Hz
 20000 h IP65
COB LED



COLOR BOX



YATO
YT-81806 3

GB LED lamp with motion detector
 D Diodenscheinwerfer mit Bewegungsmelder
 PL Reflektor diodowy z czujnikiem ruchu
 RUS Светодиодный прожектор с датчиком движения
 CZ LED reflektor se snímačem pohybu
 H Diódás reflektor mozgásérzékelővel
 RO Reflector diodă cu senzor de mișcare
 F Projecteur LED avec détecteur de mouvement
 I Faretto LED con sensore movimento
 E Reflector de diodos con sensor de movimiento
 CN 感应灯

10W 700 lm 6000 K 230V~50Hz
 12m 20000 h IP44
COB LED



COLOR BOX



YATO
YT-81801 18

GB LED lamp with motion detector
 D Diodenscheinwerfer mit Bewegungsmelder
 PL Reflektor diodowy z czujnikiem ruchu
 RUS Светодиодный прожектор с датчиком движения
 CZ LED reflektor se snímačem pohybu
 H Diódás reflektor mozgásérzékelővel
 RO Reflector diodă cu senzor de mișcare
 F Projecteur LED avec détecteur de mouvement
 I Faretto LED con sensore movimento
 E Reflector de diodos con sensor de movimiento
 CN 感应灯

20W 1400 lm 6000 K 230V~50Hz
 12m 20000 h IP44
COB LED



COLOR BOX



YATO
YT-81798 16

GB LED lamp with motion detector
 D Diodenscheinwerfer mit Bewegungsmelder
 PL Reflektor diodowy z czujnikiem ruchu
 RUS Светодиодный прожектор с датчиком движения
 CZ LED reflektor se snímačem pohybu
 H Diódás reflektor mozgásérzékelővel
 RO Reflector diodă cu senzor de mișcare
 F Projecteur LED avec détecteur de mouvement
 I Faretto LED con sensore movimento
 E Reflector de diodos con sensor de movimiento
 CN 感应灯

30W 2100 lm 6000 K 230V~50Hz
 12m 20000 h IP44
COB LED



COLOR BOX



YATO
YT-81804 6

GB LED lamp with motion detector
 D Diodenscheinwerfer mit Bewegungsmelder
 PL Reflektor diodowy z czujnikiem ruchu
 RUS Светодиодный прожектор с датчиком движения
 CZ LED reflektor se snímačem pohybu
 H Diódás reflektor mozgásérzékelővel
 RO Reflector diodă cu senzor de mișcare
 F Projecteur LED avec détecteur de mouvement
 I Faretto LED con sensore movimento
 E Reflector de diodos con sensor de movimiento
 CN 感应灯

50W 3500 lm 6000 K 230V~50Hz
 12m 20000 h IP44
COB LED



COLOR BOX



YATO
YT-81807 3

- GB Portable LED lamp
- D Diodenscheinwerfer mit Tragebügel
- PL Reflektor diodowy przenośny
- RUS Светодиодный прожектор переносной
- CZ LED reflektor přenosný
- H Hordozható, diódás reflektor
- RO Reflector diodă portabil
- F Projecteur LED
- I Faretto LED portatilea
- E Reflector de diodos portátil
- CN 手提式工作灯



- 10W
- 700 lm
- 20000 h
- IP65
- 6000 K
- 230V~50Hz
- CABLE HO5RN-F KABEL
- 1.8m
- COB LED

COLOR BOX

YATO
YT-81802 12

- GB Portable LED lamp
- D Diodenscheinwerfer mit Tragebügel
- PL Reflektor diodowy przenośny
- RUS Светодиодный прожектор переносной
- CZ LED reflektor přenosný
- H Hordozható, diódás reflektor
- RO Reflector diodă portabil
- F Projecteur LED
- I Faretto LED portatilea
- E Reflector de diodos portátil
- CN 手提式工作灯



- 20W
- 1400 lm
- 20000 h
- IP65
- 6000 K
- 230V~50Hz
- CABLE HO5RN-F KABEL
- 1.8m
- COB LED

COLOR BOX

YATO
YT-81799 8

- GB LED lamp with tripod
- D Stativ-Diodenscheinwerfer
- PL Reflektor diodowy na stojaku
- RUS Светодиодный прожектор на стойке
- CZ LED reflektor na stojanu
- H Allványos diódás reflektor
- RO Reflector diodă pe stativ
- F Projecteur LED sur un trépied
- I Riflettore LED sul cavalletto
- E Reflector de diodos con tripie
- CN 灯

- 20W
- 6000 K
- 1400 lm
- 20000 h
- 230V~50Hz
- IP65
- CABLE HO5RN-F KABEL
- 3m
- COB LED



0.7-1.8 m

WHITE BOX & COLOR LABEL

YATO
YT-81788 2

- GB LED lamp with tripod
- D Stativ-Diodenscheinwerfer
- PL Reflektor diodowy na stojaku
- RUS Светодиодный прожектор на стойке
- CZ LED reflektor na stojanu
- H Allványos diódás reflektor
- RO Reflector diodă pe stativ
- F Projecteur LED sur un trépied
- I Riflettore LED sul cavalletto
- E Reflector de diodos con tripie
- CN 灯

- 30W
- 6000 K
- 2250 lm
- 20000 h
- 230V~50Hz
- IP65
- CABLE HO5RN-F KABEL
- 3m
- COB LED

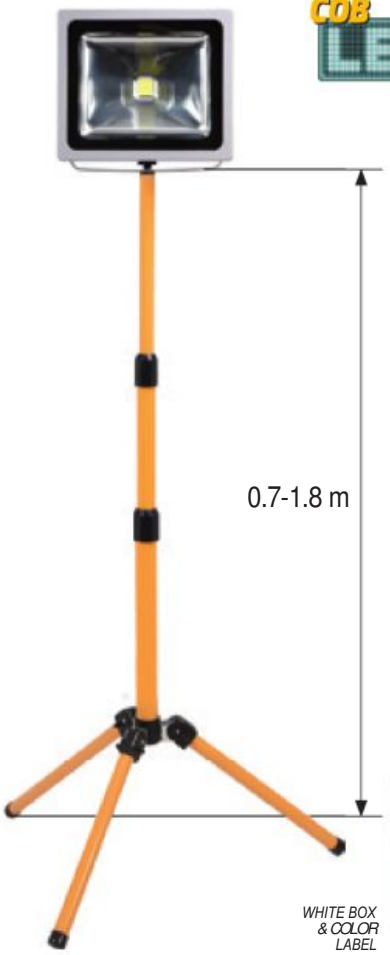

0.7-1.8 m

WHITE BOX & COLOR LABEL

YATO
YT-81810 2

- GB LED lamp with tripod
- D Stativ-Diodenscheinwerfer
- PL Reflektor diodowy na stojaku
- RUS Светодиодный прожектор на стойке
- CZ LED reflektor na stojanu
- H Allványos diódás reflektor
- RO Reflector diodă pe stativ
- F Projecteur LED sur un trépied
- I Riflettore LED sul cavalletto
- E Reflector de diodos con tripie
- CN 灯

- 20W x2
- 6000 K
- 1400lm x2
- 20000 h
- 230V~50Hz
- IP65
- CABLE HO5RN-F KABEL
- 3m
- COB LED



0.7-1.8 m

WHITE BOX & COLOR LABEL

YATO
YT-81789 4

- GB LED rechargeable floodlight
- D Akku-Diodenscheinwerfer
- PL Reflektor diodowy akumulatorowy
- RUS Светодиодный аккумуляторный прожектор
- CZ LED reflektor dobijeci
- H LED reflektor újratölthető
- RO Reflector cu led dioda pe acumulatori
- F Projecteur a LED rechargeable
- I Lampada a LED a batteria
- E LED reflector recargable
- CN 工作灯

10W	3.7V 4400mAh Li-Ion	800 lm	6000 K
Micro USB	4400mAh	CHARGING TIME COB LIGHTER 5.5 h	WORK TIME COB LIGHT 2.5 h

COB
LED



COLOR BOX

YATO	
YT-81820	6/12

- GB LED rechargeable floodlight
- D Akku-Diodenscheinwerfer
- PL Reflektor diodowy akumulatorowy
- RUS Светодиодный аккумуляторный прожектор
- CZ LED reflektor dobijeci
- H LED reflektor újratölthető
- RO Reflector cu led dioda pe acumulatori
- F Projecteur a LED rechargeable
- I Lampada a LED a batteria
- E LED reflector recargable
- CN 工作灯

10W	6V 4x AA	680 lm	3 LIGHTING MODES TWINKY BROADCAST
4400mAh	PA6 POLYESTER WINDPRO SOLAR	MAGNETIC	

COB
LED



- 3 lighting modes:
100%, 30%, strobe
- 3 tryby świecenia:
100%, 30%, pulsowanie

COLOR BOX

YATO	
YT-81821	8/16

- GB LED lamp
- D Diodenscheinwerfer
- PL Reflektor diodowy
- RUS Светодиодный прожектор
- CZ LED reflektor
- H Diódás reflektor
- RO Reflector diodă
- F Projecteur LED
- I Faretto LED
- E Reflector de diodos
- CN 工作灯

80W	6000 lm	6000 K	230V~ 50Hz	20000 h	IP65
-----	------------	--------	---------------	---------	------

COB
LED



WHITE
CARTON BOX
& COLOR LABEL

YATO	
YT-81812	3

- GB Solar LED floodlight with motion detector
- D Solar-Diodenscheinwerfer mit Bewegungsmelder
- PL Reflektor solarny LED z czujnikiem ruchu
- RUS Настенный светильник на солнечной батарее с датчиком движения
- CZ LED solarni reflektor se snimačem pohybu
- H Napelemes reflektor led mozgásérzékelővel
- RO Lampă solara cu senzör
- F LED projecteur solaire avec détecteur de mouvement
- I Lampada solare a LED con sensore di movimento
- E LED solar reflector con sensor de movimiento
- CN 带感应太阳能投光灯

4W	380 lm	4000 K	3.7V 2200mAh Li-Ion
6h	3h	10m	IP44

SMD
LED



COLOR BOX

YATO	
YT-81860	12

- GB Solar LED wall lamp
- D LED Solar-Wandleuchte
- PL Lampă solară LED
- RUS Настінний світильник
- CZ LED solární svítla
- H Fall lámpa napelemes LED
- RO Lampă solara pt. perete
- F Lampe solaire LED
- I Lampada da parete LED solare
- E Luz de pared de LED solar
- CN 太阳能感应壁灯

SMD
LED

120 lm	3.7V 900mAh Li-Ion
8 h	12 h
3m	IP65

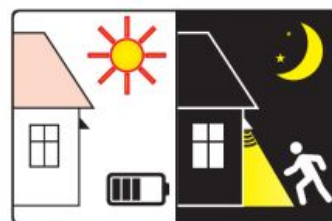

COLOR BOX

YATO	
YT-81855	12/48

- GB Solar LED wall lamp
D LED Solar-Wandleuchte
PL Lampa ścienna solarna LED
RUS Настінний світильник
CZ LED solární světlá
H Fali lámpa napelemes LED
RO Lampă solara pt. perete
F Lampe solaire LED
I Lampada da parete LED solare
E Luz de pared de LED solar
CN 太阳能感应壁灯



SMD LED

120 lm	3.7V 900mAh Li-Ion
CHARGING TIME CZAS ŁADUNKI 8 h	WORK TIME CZAS PRACY 12 h
	IP65

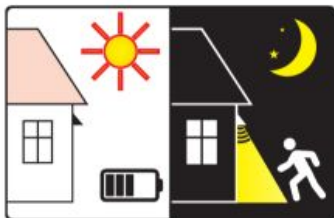

COLOR BOX



YATO
YT-81856 12/48

- GB Solar LED floodlight with spike
D Solar-Diodenscheinwerfer mit Spitze
PL Reflektor solarny LED ze szpiculcem
RUS Настенный светильник на солнечной батарее со шпиком
CZ LED solární reflektor s hrotem
H Napelemes reflektor LED tűskével
RO Lampă solara cu vâr
F LED projecteur solaire avec avec pique
I Lampada solare a LED con punta
E LED solar reflector con pincho
CN 带感应太阳能地插灯

LED

4 LED	2W	3.7V 2200mAh Li-Ion	180 lm
CHARGING TIME CZAS ŁADUNKI 6h	WORK TIME CZAS PRACY 6h		
IP44			



COLOR BOX



YATO
YT-81880 20



- GB Workshop LED battery lamp
D LED Akku-handleuchte
PL Diodowa lampa warsztatowa akumulatorowa
RUS Светодиодная беспроводная лампа
CZ Ruční svítilna LED
H LED szerelő lámpák
RO Lampă portabilă cu acumulator leduri
F Lampe a LED rechargeable
I Lampada LED per officina
E Linterna LED recargable
CN 可充長款針腳

HANGING COLOR BOX



CRI 95	5W	3.7V 2600mAh Li-Ion	400 lm
4500K	CHARGING TIME CZAS ŁADUNKI 4h	WORK TIME CZAS PRACY 4h	
IP65	IK07		2x

COB LED

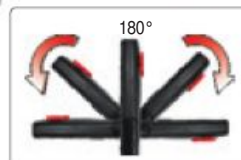

YATO
YT-08509 12



COLOR INSPECTION LAMP
LAMPĂ DO INSPEKȚII LĂKIERU



- GB Workshop LED battery lamp
D LED Akku-handleuchte
PL Diodowa lampa warsztatowa akumulatorowa
RUS Светодиодная беспроводная лампа
CZ Ruční svítilna LED
H LED szerelő lámpák
RO Lampă portabilă cu acumulator leduri
F Lampe a LED rechargeable
I Lampada LED per officina
E Linterna LED recargable
CN 可充長款針腳

FRONT LIGHTING
FUNKCIJA LADUNGA

1+1 LED	3.7V 3600mAh Li-Ion	180 lm
230V~ 50Hz BATTERY CHARGER LADUNGARKA	12V BATTERY CHARGER LADUNGARKA	
CHARGING TIME CZAS ŁADUNKI 4h	WORK TIME CZAS PRACY 3 h 2 LED	
HOOK HAK		
MAGNETIC		

COB LED



COLOR BOX



YATO
YT-08502 10

GB Workshop LED battery lamp
 D LED Akku-handleuchte
 PL Diodowa lampa warsztatowa akumulatorowa
 RUS Светодиодная беспроводная лампа
 CZ Ruční svítidla LED
 H LED szerelő lámpák
 RO Lampa portabila cu acumulator leduri
 F Lampe a LED rechargeable
 I Lampada LED per officina
 E Linterna LED recargable
 CN 可充裝款針脩



FRONT LIGHTING FUNKCJA LAMPY	2W	3.7V 1100mAh Li-Ion
	200 lm	CHARGING TIME CZAS ŁADOWANIA 2.5 h
USB BATTERY CHARGER ŁADOWNIK	WORK TIME CZAS PRACY 2.5 h	
IP54	HOOK HAK	
POLYCARBONATE DIFFUSER KŁOSZ Z POLIWĘGLANU	x2	

COB
LED

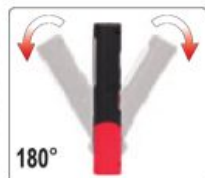

YATO
YT-08501 20

GB Workshop LED battery lamp
 D LED Akku-handleuchte
 PL Diodowa lampa warsztatowa akumulatorowa
 RUS Светодиодная беспроводная лампа
 CZ Ruční svítidla LED
 H LED szerelő lámpák
 RO Lampa portabila cu acumulator leduri
 F Lampe a LED rechargeable
 I Lampada LED per officina
 E Linterna LED recargable
 CN 可充裝款針脩



FRONT LIGHTING FUNKCJA LAMPY	3W	3.7V 2200mAh Li-Ion
	350 lm	CHARGING TIME CZAS ŁADOWANIA 4h
USB BATTERY CHARGER ŁADOWNIK	WORK TIME CZAS PRACY 3.5 h	
IP54	HOOK HAK	
POLYCARBONATE DIFFUSER KŁOSZ Z POLIWĘGLANU	x2	

COB
LED

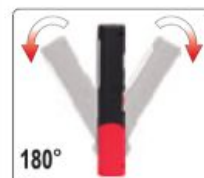

YATO
YT-08560 12

GB Workshop LED battery lamp
 D LED Akku-handleuchte
 PL Diodowa lampa warsztatowa akumulatorowa
 RUS Светодиодная беспроводная лампа
 CZ Ruční svítidla LED
 H LED szerelő lámpák
 RO Lampa portabila cu acumulator leduri
 F Lampe a LED rechargeable
 I Lampada LED per officina
 E Linterna LED recargable
 CN 可充裝款針脩



FRONT LIGHTING FUNKCJA LAMPY	5+3 W	3.7V 2600mAh Li-Ion	CHARGING TIME CZAS ŁADOWANIA 4h
	600/260 lm	6500 K	WORK TIME CZAS PRACY 2.5/5.5 h
USB BATTERY CHARGER ŁADOWNIK	MAGNETIC	POLYCARBONATE DIFFUSER KŁOSZ Z POLIWĘGLANU	

COB
LED

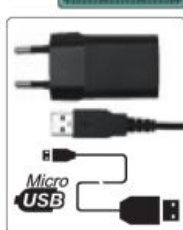

YATO
YT-08518 12

GB Workshop LED battery lamp
 D LED Akku-handleuchte
 PL Diodowa lampa warsztatowa akumulatorowa
 RUS Светодиодная беспроводная лампа
 CZ Ruční svítidla LED
 H LED szerelő lámpák
 RO Lampa portabila cu acumulator leduri
 F Lampe a LED rechargeable
 I Lampada LED per officina
 E Linterna LED recargable
 CN 可充裝款針脩



FRONT LIGHTING FUNKCJA LAMPY	7+3 W	3.7V 2600mAh Li-Ion	CHARGING TIME CZAS ŁADOWANIA 4.5h
	60-600 lm	6500 K	WORK TIME CZAS PRACY 1.5-16.5h
LED CHARGE INDICATOR WSKAZNIK NAŁADOWNIKA BATERII	HOOK HAK	POLYCARBONATE DIFFUSER KŁOSZ Z POLIWĘGLANU	

COB
LED

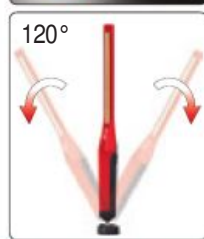

YATO
YT-08519 12

- GB Workshop LED battery lamp
D LED Akku-handleuchte
PL Diodowa lampa warsztatowa akumulatorowa
RUS Светодиодная беспроводная лампа
CZ Ruční svítidla LED
H LED szerelő lámpák
RO Lampa portabila cu acumulator leduri
F Lampe a LED rechargeable
I Lampada LED per officina
E Linterna LED recargable
CN 可充裝款鉗腳



3W	3.7V 2200mAh Li-Ion
250 lm	6000 K
230V-50Hz BATTERY CHARGER LADONAWKA	CHARGING TIME CZAS ŁADOWNIA 5h
IP54	WORK TIME CZAS PRACY 3.5 h
IK07	HOOK HAK
POLYCARBONATE DIFFUSER KŁOSZ Z POLIWĘGLANU	MAGNETIC

COB
LED



YATO
YT-08563 10

HANGING
COLOR BOX
WITH WINDOW

- GB Workshop LED battery lamp
D LED Akku-handleuchte
PL Diodowa lampa warsztatowa akumulatorowa
RUS Светодиодная беспроводная лампа
CZ Ruční svítidla LED
H LED szerelő lámpák
RO Lampa portabila cu acumulator leduri
F Lampe a LED rechargeable
I Lampada LED per officina
E Linterna LED recargable
CN 可充裝款鉗腳



3.5+3 W	3.7V 2200mAh Li-Ion
280 lm	6000 K
USB BATTERY CHARGER LADONAWKA	CHARGING TIME CZAS ŁADOWNIA 4h
IP54	WORK TIME CZAS PRACY 3.5 h
IK07	HOOK HAK
POLYCARBONATE DIFFUSER KŁOSZ Z POLIWĘGLANU	x2 HOOK HAK
	x3

SMD
LED



YATO
YT-08508 12

HANGING
COLOR BOX

- GB Workshop LED battery lamp
D LED Akku-handleuchte
PL Diodowa lampa warsztatowa akumulatorowa
RUS Светодиодная беспроводная лампа
CZ Ruční svítidla LED
H LED szerelő lámpák
RO Lampa portabila cu acumulator leduri
F Lampe a LED rechargeable
I Lampada LED per officina
E Linterna LED recargable
CN 可充裝款鉗腳

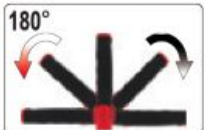

30+7 LED	140 lm	3.7V 2000mAh Li-Ion
USB BATTERY CHARGER LADONAWKA	WORK TIME CZAS PRACY 4h	CHARGING TIME CZAS ŁADOWNIA 4h
x3	HOOK HAK	POLYCARBONATE DIFFUSER KŁOSZ Z POLIWĘGLANU

LED



YATO
YT-08507 12

HANGING
COLOR BOX

- GB Workshop LED battery lamp
D LED Akku-handleuchte
PL Diodowa lampa warsztatowa akumulatorowa
RUS Светодиодная беспроводная лампа
CZ Ruční svítidla LED
H LED szerelő lámpák
RO Lampa portabila cu acumulator leduri
F Lampe a LED rechargeable
I Lampada LED per officina
E Linterna LED recargable
CN 可充裝款鉗腳



1+7 LED	250 lm	3.7V 1800mAh Li-Ion	12V BATTERY CHARGER LADONAWKA
USB BATTERY CHARGER LADONAWKA	WORK TIME CZAS PRACY 4h	CHARGING TIME CZAS ŁADOWNIA 4h	WORK TIME CZAS PRACY 4h
x2	HOOK HAK	x2	

COB
LED



YATO
YT-08504 10

COLOR
BOX

- GB Workshop LED battery lamp
- D LED Akku-handleuchte
- PL Diodowa lampa warsztatowa akumulatorowa
- RUS Светодиодная беспроводная лампа
- CZ Ruční svítilna LED
- H LED szerelő lámpák
- RO Lampa portabila cu acumulator leduri
- F Lampe a LED rechargeable
- I Lampada LED per officina
- E Linterna LED recargable
- CN 可充式射灯

30+7 LED	85 lm	3.7V 1800mAh (Li-ion)	12V BATTERY CHARGER LADOWARKA
	230V~50Hz BATTERY CHARGER LADOWARKA	CHARGING TIME 4-5 h	
WORK TIME 15h 7LED	WORK TIME 4h 30LED	HOOK x2	MAGNETIC x2



- GB LED workshop lamp
- D LED Werkstattlampe
- PL Diodowa lampa warsztatowa
- RUS Светодиодная беспроводная лампа
- CZ Montážní lampa
- H LED lámpa
- RO Lampa cu LED
- F Lampe d'atelier a LED
- I Lampada LED per autofficina
- E Lámpara de taller LED
- CN 可充式射灯

27 LED	13000 MCD	3.6V 1200mAh (Ni-MH)	
12V BATTERY CHARGER LADOWARKA	230V~50Hz BATTERY CHARGER LADOWARKA	CHARGING TIME 4h	WATER PROOF ODPORNA NA WODE
WORK TIME 4h	CHARGING TIME 4h	HOOK HAK	MAGNETIC



- GB LED workshop lamp
- D LED Werkstattlampe
- PL Diodowa lampa warsztatowa
- RUS Светодиодная беспроводная лампа
- CZ Montážní lampa
- H LED szerelő lámpák
- RO Lampa cu LED
- F Lampe d'atelier a LED
- I Lampada LED per autofficina
- E Lámpara de taller LED
- CN 可充式射灯

60+1 LED	13000 MCD	7.2V 800mAh (Ni-MH)	230V~50Hz BATTERY CHARGER LADOWARKA
WORK TIME 4h	CHARGING TIME 4h	WATER PROOF ODPORNA NA WODE	
12V BATTERY CHARGER LADOWARKA	HOOK HAK	MAGNETIC	



- GB LED workshop lamp
- D LED Werkstattlampe
- PL Diodowa lampa warsztatowa
- RUS Светодиодная беспроводная лампа
- CZ Montážní lampa
- H LED szerelő lámpák
- RO Lampa cu LED
- F Lampe d'atelier a LED
- I Lampada LED per autofficina
- E Lámpara de taller LED
- CN 可充式射灯

8+1 LED	280 lm	3 LIGHTING OPTIONS	FRONT LIGHTING (PUNTA/LATA)
WORK TIME 4h 9 LED	1.5V 3x AA	HOOK HAK	MAGNETIC



GB LED workshop lamp
D LED Werkstattlampe
PL Diodowa lampa warsztatowa
RUS Светодиодный светильник для мастерской
CZ Montážní lampa
H LED szerelő lámpák
RO Lampa cu LED
F Lampe d'atelier a LED
I Lampada LED per autofficina
E Lámpara de taller LED
CN 可充長款針腳



8 LED
80 lm
1.5V 3x AAA
WORK TIME / CZAS PRACY 20 h / 8 LED

SMD LED



SLIDING CARD



YATO
YT-08514 12/72

GB LED workshop lamp
D LED Werkstattlampe
PL Diodowa lampa warsztatowa
RUS Светодиодный светильник для мастерской
CZ Montážní lampa
H LED szerelő lámpák
RO Lampa cu LED
F Lampe d'atelier a LED
I Lampada LED per autofficina
E Lámpara de taller LED
CN 可充長款針腳



4 LED
400 lm
IP65
230V~50Hz
CABLE / KABEL HOSRN-F
HOOK HAK
4.9m

POWER LED



YATO
YT-08531 10

GB Workshop LED battery lamp
D LED Akku-handleuchte
PL Diodowa lampa warsztatowa akumulatorowa
RUS Светодиодная лампа LED

CZ Ruční svítlna LED
H LED szerelő lámpák
RO Lampa portabila cu acumulator leduri
F Lampe a LED rechargeable

I Lampada LED trasportabile per illuminazione di vani motore
E Linterna LED recargable
CN 引擎蓋檢修燈

SMD LED

100 LED
600 lm
7.4V 2000mAh Li-Ion
3-4 h
4 h / 100 LED
HOOK HAK
MAGNETIC



YATO
YT-08503 8

GB Workshop LED battery lamp
D LED Akku-handleuchte
PL Diodowa lampa warsztatowa akumulatorowa
RUS Светодиодная лампа LED

CZ Ruční svítlna LED
H LED szerelő lámpák
RO Lampa portabila cu acumulator leduri
F Lampe a LED rechargeable

I Lampada LED trasportabile per illuminazione di vani motore
E Linterna LED recargable
CN 引擎蓋檢修燈

LED

350 lm
60 LED
120 LED
7.2V 1800mAh Ni-MH
8 h / 60 LED
4 h / 120 LED
4-5 h
HOOK HAK
MAGNETIC



YATO
YT-08530 4

GB Workshop LED battery lamp
D LED Akku-handleuchte
PL Diodowa lampa warsztatowa akumulatorowa
RUS Светодиодная лампа LED

CZ Ruční svítlna LED
H LED szerelő lámpák
RO Lampa portabila cu acumulator leduri
F Lampe a LED rechargeable

I Lampada LED trasportabile per illuminazione di vani motore
E Linterna LED recargable
CN 引擎蓋檢修燈

SMD LED

36 LED
18 LED
36 LED
7.4V 2400mAh Li-Ion
5.5 h
3.5 h
HOOK HAK
MAGNETIC



YATO
YT-08533 4

GB Workshop LED battery lamp
 D LED Akku-handleuchte
 PL Diodowa lampa warsztatowa akumulatorowa
 RUS Светодиодная лампа LED

CZ Ruční svítilna LED
 H LED szerelő lámpák
 RO Lampa portabila cu acumulator leduri
 F Lampe a LED rechargeable

I Lampada LED trasportabile per illuminazione di vani motore
 E Linterna LED recargable
 CN 引擎盖检修灯

SMD LED

12W	1200 lm	4000 K	230V~50Hz	CABLE H05RN-F KABEL
5m	2x 1.0mm ²	POLYCARBONATE DIFFUSER KÜGEL Z POLYURETHAN	HOOK HAK	IP54



GB UV LED flashlight and glasses set
 D UV LED-Taschenlampe mit UV Schutzbrille
 PL Zestaw latarka UV LED i okulary
 RUS Комплект для проверки утечек хладагента - УФ фонарь LED

UV LED

51 LED	UV
395 nm	1.5V 3x AA

CZ UV LED svítilna + brýle
 H UV LED zseblámpa + szemüveg
 RO Set lanterna UV LED si ochelari
 F UV LED lampe de poche avec lunettes
 I Set torcia UV LED e occhiali
 E UV LED linterna con gafas para
 CN 手电筒



YATO
YT-08581 40

GB LED Flashlight
 D LED Taschenlampe
 PL Latarka LED
 RUS Светодиодный фонарь
 CZ LED svítilna
 H LED zseblámpal
 RO Lanterna cu LED
 F LED lampe de torche

6W	XPG3	500 lm	230 m
4 LIGHTING MODES	IPX7	6V 4x AA	



GB LED Flashlight
 D LED Taschenlampe
 PL Latarka LED
 RUS Светодиодный фонарь
 CZ LED svítilna
 H LED zseblámpal

10W	XPL	1000 lm	350 m
3 LIGHTING MODES	ZOOM	IPX4	6V 4x AAA



GB LED Flashlight
 D LED Taschenlampe
 PL Latarka LED
 RUS Светодиодный фонарь
 CZ LED svítilna
 H LED zseblámpal
 RO Lanterna cu LED
 F LED lampe de torche

3W	XPE2	200 lm	120 m
2 LIGHTING MODES	IPX4	3V 2x AAA	



GB LED Flashlight
 D LED Taschenlampe
 PL Latarka LED
 RUS Светодиодный фонарь
 CZ LED svítilna
 H LED zseblámpal
 RO Lanterna cu LED
 F LED lampe de torche

5W	XPG2	300 lm	150 m
3 LIGHTING MODES	ZOOM	IPX4	4.5V 3x AAA



GB LED Flashlight
 D LED Taschenlampe
 PL Latarka LED
 RUS Светодиодный фонарь
 CZ LED svítilna
 H LED zseblámpal
 RO Lanterna cu LED
 F LED lampe de torche

6W	XPG3	500 lm
200 m	3 LIGHTING MODES	ZOOM
3.7V 2200mAh Li-Ion	IPX7	USB BATTERY CHARGER LAZDNIK

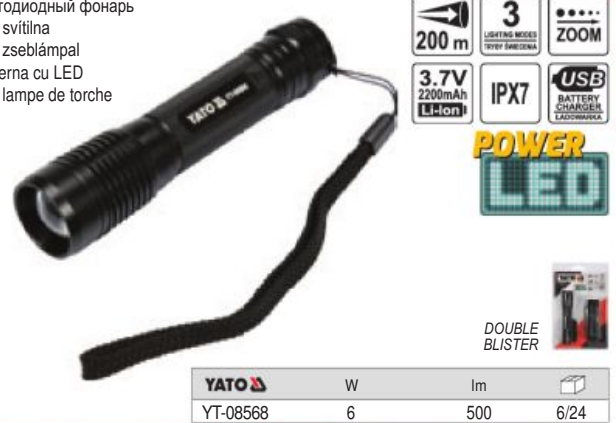

GB LED Flashlight
D LED Taschenlampe
PL Latarka LED
RUS Светодиодный фонарь
CZ LED svítilna
H LED zseblámpal
RO Lanterna cu LED

F LED lampe de torche
I Torcia LED
E Linterna LED
CN 手电筒

5W XTE 350 lm
150 m 4 LIGHTING MODES TYPY ŚWIĘCENIA ZOOM
3.7 V 650 mAh Li-Ion I USB BATTERY CHARGER ŁADOWNICZKA IPX4
POWER LED



YATO	W	lm	
YT-08569	5	350	12/96

DOUBLE BLISTER

GB LED Flashlight
D LED Taschenlampe
PL Latarka LED
RUS Светодиодный фонарь
CZ LED svítilna
H LED zseblámpal

RO Lanterna cu LED
F LED lampe de torche
I Torcia LED
E Linterna LED
CN 手电筒

3W 130 lm ZOOM
IP64 1.5V 2x C WATER PROOF ODPORNA NA WODĘ



YATO	W	lm	
YT-08577	3	130	12/48

POWER LED

SLIDING CARD



GB LED Flashlight
D LED Taschenlampe
PL Latarka LED
RUS Светодиодный фонарь
CZ LED svítilna
H LED zseblámpal

RO Lanterna cu LED
F LED lampe de torche
I Torcia LED
E Linterna LED
CN 手电筒

3W 100 lm ZOOM
IP64 1.5V 2x AA WATER PROOF ODPORNA NA WODĘ



YATO	W	lm	
YT-08575	3	100	12/72

SLIDING CARD



GB LED Flashlight
D LED Taschenlampe
PL Latarka LED
RUS Светодиодный фонарь
CZ LED svítilna
H LED zseblámpal

RO Lanterna cu LED
F LED lampe de torche
I Torcia LED
E Linterna LED
CN 手电筒

3W 110 lm ZOOM
IP64 1.5V AA WATER PROOF ODPORNA NA WODĘ



YATO	W	lm	
YT-08572	3	110	12/72

POWER LED

SLIDING CARD



GB LED Flashlight
D LED Taschenlampe
PL Latarka LED
RUS Светодиодный фонарь
CZ LED svítilna
H LED zseblámpal
RO Lanterna cu LED
F LED lampe de torche

I Torcia LED
E Linterna LED
CN 手电筒

3W 100 lm ZOOM IP64
1.5V AA WATER PROOF ODPORNA NA WODĘ



YATO	W	lm	
YT-08571	3	100	24/96

SLIDING CARD



GB LED Flashlight
D LED Taschenlampe
PL Latarka LED
RUS Светодиодный фонарь
CZ LED svítilna
H LED zseblámpal
RO Lanterna cu LED
F LED lampe de torche
I Torcia LED
E Linterna LED
CN 手电筒



YATO			
YT-08570			24/192

9 LED 1.5V 3x AAA WATER PROOF ODPORNA NA WODĘ

SLIDING CARD



GB LED head lamp
D LED kopflampe
PL Diodowa lampka czołowa
RUS Налобный светодиодный фонарь
CZ LED montážní lampka - čelovka
H LED fejlámpa
RO Lampa cu LED
F Lampe frontale LED
I Lampada da testa
E Linterna de diodo
CN LED头灯

10W XM-L2 450 lm ZOOM 3 LIGHTING MODES TYPY ŚWIĘCENIA 6V 4x AAA



YATO	W	lm	
YT-08591	10	450	6/24

DOUBLE BLISTER



GB LED head lamp
D LED kopflampe
PL Diodowa lampka czołowa
RUS Налобный светодиодный фонарь
CZ LED montážní lampka - čelovka
H LED fejlámpa
RO Lampa cu LED
F Lampe frontale LED
I Lampada da testa
E Linterna de diodo
CN LED头灯



YATO	W	lm	
YT-08590	3	100	50/100

3W 100 lm ZOOM WATER PROOF ODPORNA NA WODĘ 1.5V 3x AAA

POWER LED

SLIDING CARD



- GB Rubber protection extension cord
- D Gummiisolierte Verlängerungsschnur
- PL Przedłużacz w osłonie gumowej
- RUS Удлинитель с резиновой изоляцией
- CZ Prodlužovací kabel s gumovou izolací
- H Gumi szigetelésű hosszabbító
- RO Cablu prelungitor cauciuc
- F Rallonge électrique
- I Prolunga in gomma
- E Cable de extensión con protección de caucho
- CN 电缆延长线



CABLE 3G1.5
H05RR-F mm²
KABEL CABLE / KABEL

YATO	L (m)	
YT-81021	10	8
YT-81022	20	4
YT-81023	30	4
YT-81024	40	2

IP44 16A EAF TYPE / TYP E TYPE / TYP 230V~50Hz



CABLE 3G2.5
H05RR-F mm²
KABEL CABLE / KABEL

YATO	L (m)	
YT-8100	20	4
YT-8101	30	2
YT-8102	40	2

COLOR BOX



CABLE 3G1.5
H07RN-F mm²
KABEL CABLE / KABEL

YATO	L (m)	
YT-8111	5	16
YT-8112	10	8



CABLE 3G1.5
H07RN-F mm²
KABEL CABLE / KABEL

YATO	L (m)	
YT-8116	10	4
YT-81162	20	4

- GB Cable reel
- D Kabeltrommel
- PL Przedłużacz zwijany
- RUS Удлинитель электрический
- CZ Bubnový prodlužovač
- H Kábeldob
- RO Prelungitor pe tambur
- F Rallonge électrique sur tambour enrouleur
- I Avvolgicavo con bobina
- E Cable de prolongación de tambor
- CN 电缆延长线

IP44 16A

CABLE 3G1.5
H05RR-F mm²
KABEL CABLE / KABEL

EAF TYPE / TYP E TYPE / TYP

230V~50Hz



- P_{max} = 1000 W coiled
- P_{max} = 1000 W zwinięty
- P_{max} = 3000 W uncoiled
- P_{max} = 3000 W rozwinięty

POLYBAG

YATO	L (m)	
YT-81052	20	2
YT-81053	30	2
YT-81054	40	2

- GB Cable reel
- D Kabeltrommel
- PL Przedłużacz zwijany
- RUS Удлинитель электрический
- CZ Bubnový prodlužovač
- H Kábeldob
- RO Prelungitor pe tambur
- F Rallonge électrique sur tambour enrouleur
- I Avvolgicavo con bobina
- E Cable de prolongación de tambor
- CN 电缆延长线

IP44 16A

CABLE 3G2.5
H05RR-F mm²
KABEL CABLE / KABEL

EAF TYPE / TYP E TYPE / TYP

230V~50Hz



- P_{max} = 1200 W coiled
- P_{max} = 1200 W zwinięty
- P_{max} = 3600 W uncoiled
- P_{max} = 3600 W rozwinięty

POLYBAG

YATO	L (m)	
YT-8106	30	1
YT-8107	40	1
YT-8108	50	1

- GB Drum power extension cord
- D Verlängerungstrommel für Kraftstrom
- PL Przedłużacz bębnowy siłowy
- RUS Силовой удлинитель барабанного типа
- CZ Prodlužovací kabel silový na bubnu
- H Háromfázisú hosszabbító dob
- RO Derulator cu tambur
- F Rallonge électrique sur tambour enrouleur
- I Avvolgicavo di forza
- E Cilindro de extensión de fuerza
- CN 电缆延长线

IP44 16A

CABLE 5G2.5
H07RN-F mm²
KABEL CABLE / KABEL

3P+N+E 3P+N+E 2x 2P+E

~400V ~230V



- ~230V; 2P+E
- P_{max} = 1200 W coiled
- P_{max} = 1200 W zwinięty
- P_{max} = 3000 W uncoiled
- P_{max} = 3000 W rozwinięty
- ~400V; 3P+N+E
- P_{max} = 3000 W coiled
- P_{max} = 3000 W zwinięty
- P_{max} = 9000 W uncoiled
- P_{max} = 9000 W rozwinięty

POLYBAG

YATO	L (m)	
YT-8120	25	1

Memo

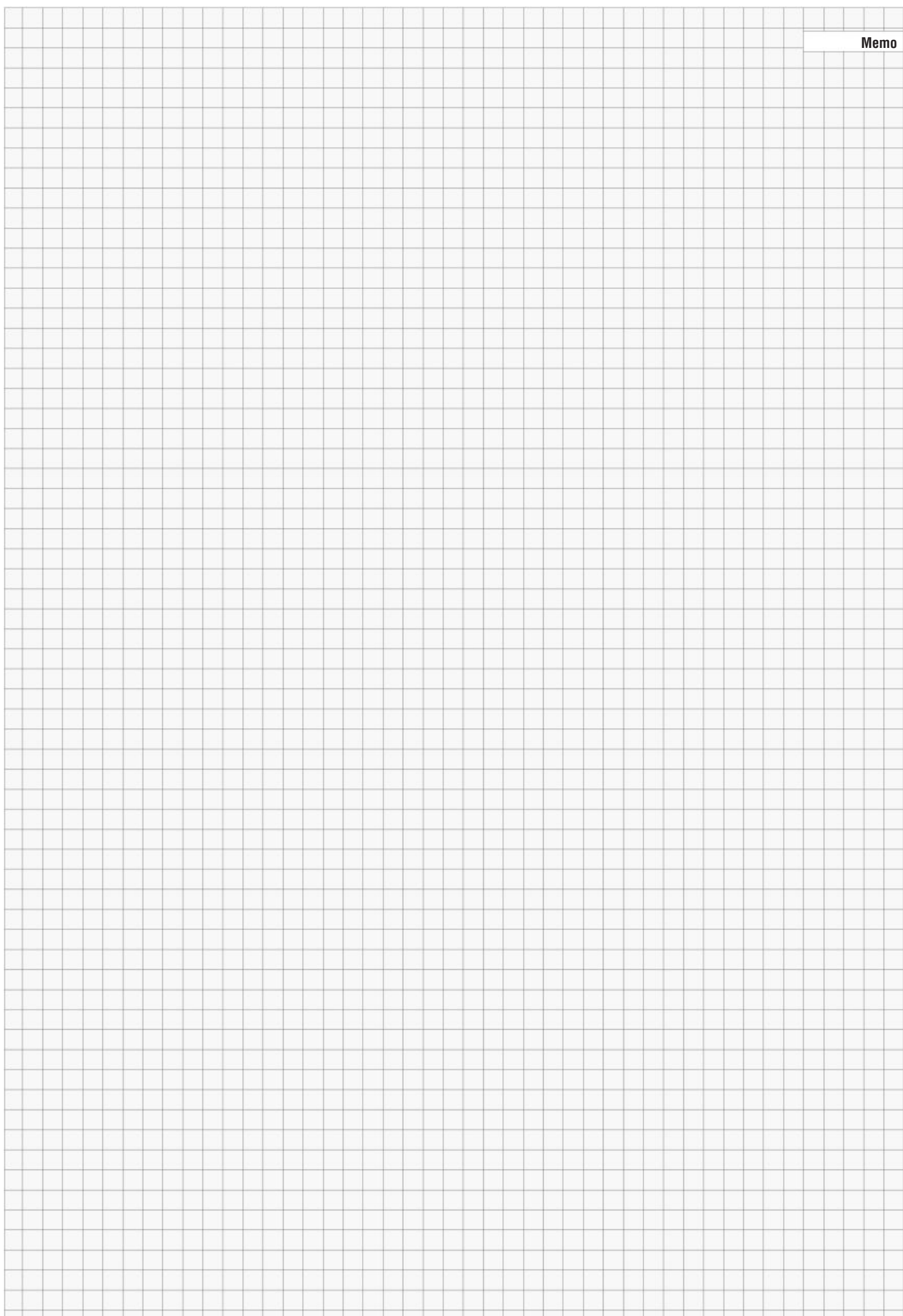

22

Garden tools
Narzędzia ogrodnicze



Watering program Program wodny	
486-492	

Hose connectors, male connectors, couplings, hose menders Złącza, nypły, łączniki, rozgałęźniacze, reparatory	486
Hose nozzles (sprinklers) & sets Zraszacze i zestawy	488
Garden hose holders Stojaki na węże ogrodowe	492
Pumps Pompy	492

Pruners & shears Sekatory i nożyce ogrodowe	
493-497	

Pruners Sekatory	493
Lopping shears Sekatory do gałęzi	495
Leverage tree pruners Sekatory gąsienicowe	496
Hedge shears Nożyce do żywopłotu	497
Grass shears Nożyce do trawy	497

Bow saws & blades Piły kabłąkowe i brzeszczoty	
498	

Axes Siekierki	
498	

Hand tools Narzędzia ręczne	
499-500	

Small garden tools Małe narzędzia ogrodowe	499
Big garden tools Duże narzędzia ogrodowe	500

Cordless garden tools & accessories Ogrodowe narzędzia akumulatorowe i akcesoria	
501-504	

Cordless chainsaws Akumulatorowe pilarki łańcuchowe	501
Cordless grass trimmers Akumulatorowe wykasarki	501
Cordless hedge trimmers Akumulatorowe nożyce do żywopłotu	503

Electric garden tools Ogrodowe narzędzia elektryczne	
504-505	

Electric lawn mowers Kosiarki elektryczne	504
---	-----

Gasoline garden tools & accessories Ogrodowe narzędzia spalinowe i akcesoria	
505-512	

Gasoline sprayers Opryskiwacze spalinowe	505
Gasoline chainsaws Pilarki spalinowe	505
Gasoline brushcutters Kosy spalinowe	506
Gasoline hedge trimmers Spalinowe nożyce do żywopłotu	506
Accessories Akcesoria	507

GB Hose connector
 D Universal
 PL Złącze standard
 RUSСоединитель
 CZ Rychlospojka
 H Fitting
 RO Mufă pt. pistol
 F Raccord standard
 I Connettore standard
 E Junta estandar
 CN 通水接头



TIED ON CARD

YATO	size / rozmiar	
YT-99801	1/2" 12.5 mm	12/120

GB Waterstop hose connector
 D Universal
 PL Złącze standard
 RUSСоединитель с автостопом
 CZ Rychlospojka
 H Fitting
 RO Mufă pt. pistol
 F Raccord stop
 I Connettore stop
 E Junta estandar
 CN 止水接头



TIED ON CARD

YATO	size / rozmiar	
YT-99803	1/2" 12.5 mm	12/120

GB Hose connector
 D Universal
 PL Złącze standard
 RUSСоединитель
 CZ Rychlospojka
 H Fitting
 RO Mufă pt. pistol
 F Raccord standard
 I Connettore standard
 E Junta estandar
 CN 通水接头



TIED ON CARD

YATO	size / rozmiar	
YT-99802	3/4" 19.0 mm	12/120

GB Waterstop hose connector
 D Universal
 PL Złącze stop
 RUSСоединитель с автостопом
 CZ Rychlospojka
 H Fitting
 RO Mufă pt. pistol
 F Raccord stop
 I Connettore stop
 E Junta estandar
 CN 止水接头

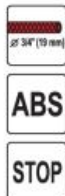

TIED ON CARD

YATO	size / rozmiar	
YT-99804	3/4" 19.0 mm	12/120

GB Hose mender
 D Schlauchreparator,
 Schlauchverbinder
 PL Reparatör do węzła
 RUSСоединитель шлангов
 CZ Opravka
 H Gyorstoldó
 RO Mufă înădire
 F Réparateur de tuyau
 I Tubo reparatore
 E Reparador para manguera
 CN 修补接头



TIED ON CARD

YATO	size / rozmiar	
YT-99810	1/2" 12.5 mm	12/120

GB Hose mender
 D Schlauchreparator,
 Schlauchverbinder
 PL Reparatör do węzła
 RUSСоединитель шлангов
 CZ Opravka
 H Gyorstoldó
 RO Mufă înădire
 F Réparateur de tuyau
 I Tubo reparatore
 E Reparador para manguera
 CN 修补接头



TIED ON CARD

YATO	size / rozmiar	
YT-99811	3/4" 19.0 mm	12/120

GB Hose mender
 D Schlauchreparator,
 Schlauchverbinder
 PL Reparatör do węzła
 RUSСоединитель шлангов
 CZ Opravka
 H Gyorstoldó
 RO Mufă înădire
 F Réparateur de tuyau
 I Tubo reparatore
 E Reparador para manguera
 CN 修补接头



TIED ON CARD

YATO	size / rozmiar	
YT-8979	1/2"; 3/4" 12.5; 19.0 mm	24/240

GB Snap-in tap adaptor
 D Wasserhahnanschluss
 für Gartenschlauch
 PL Przyłącze do kranu
 RUSАдаптер внутренний
 CZ Šroubení
 H Tömlövég csaphoz
 RO Mufă pt. robinet
 cu filet interior
 F Raccord
 I Collegamento al rubinetto
 E Tubuladura de grifo
 CN 铁箍接头

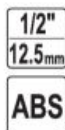

TIED ON CARD

YATO	size / rozmiar	
YT-8970	1/2" 12.5 mm	24/240

GB Snap-in tap adaptor
 D Wasserhahnanschluss
 für Gartenschlauch
 PL Przyłącze do kranu
 RUSАдаптер внутренний
 CZ Šroubení
 H Tömlövég csaphoz
 RO Mufă pt. robinet
 cu filet interior
 F Raccord
 I Collegamento al rubinetto
 E Tubuladura de grifo
 CN 铁箍接头



TIED ON CARD

YATO	size / rozmiar	
YT-8971	3/4" 19.0 mm	12/120

GB Snap-in tap adaptor
 D Wasserhahnanschluss
 für Gartenschlauch
 PL Przyłącze do kranu
 RUSАдаптер внутренний
 CZ Šroubení
 H Tömlövég csaphoz
 RO Mufă pt. robinet
 cu filet interior
 F Raccord
 I Collegamento al rubinetto
 E Tubuladura de grifo
 CN 铁箍接头



TIED ON CARD

YATO	size / rozmiar	
YT-99812	3/4" 19.0 mm	12/120

GB Snap-in tap adaptor
 D Wasserhahnanschluss
 für Gartenschlauch
 PL Przyłącze do kranu
 RUSАдаптер внутренний
 CZ Šroubení
 H Tömlövég csaphoz
 RO Mufă pt. robinet
 cu filet interior
 F Raccord
 I Collegamento al rubinetto
 E Tubuladura de grifo
 CN 铁箍接头



TIED ON CARD

YATO	size / rozmiar	
YT-8972	1" 25.0 mm	12/120

GB Snap-in tap adaptor
 D Wasserhahnanschluss
 für Gartenschlauch
 PL Przyłącze do kranu
 RUSАдаптер внутренний
 CZ Šroubení
 H Tömlövég csaphoz
 RO Mufă pt. robinet
 cu filet interior
 F Raccord
 I Collegamento al rubinetto
 E Tubuladura de grifo
 CN 铁箍接头

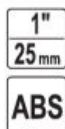

TIED ON CARD

YATO	size / rozmiar	
YT-99813	1" 25.0 mm	12/120

GB Snap-in tap adaptor
D Wasserhahnanschluss für Gartenschlauch
PL Przyłącze do kranu
RUSAдаптер внутренний
CZ Šroubení
H Tömlovég csaphoz
RO Mufă pt. robinet cu file interior
F Raccord
I Collegamento al rubinetto
E Tubuladura de grifo
CN 铁箍接头

1/2"
12.5mm
3/4"
19mm
ABS



TIED ON CARD

YATO	size / rozmiar	
YT-8973	1/2"; 3/4" 12.5; 19.0 mm	12/120

GB Snap-in tap adaptor
D Wasserhahnanschluss für Gartenschlauch
PL Przyłącze do kranu
RUSAдаптер внутренний
CZ Šroubení
H Tömlovég csaphoz
RO Mufă pt. robinet cu file interior
F Raccord
I Collegamento al rubinetto
E Tubuladura de grifo
CN 铁箍接头

1/2"
12.5mm
3/4"
19mm
ABS



TIED ON CARD

YATO	size / rozmiar	
YT-99814	1/2"; 3/4" 12.5; 19.0 mm	12/120

GB Snap-in tap adaptor
D Wasserhahnanschluss für Gartenschlauch
PL Przyłącze do kranu
RUSAдаптер внутренний
CZ Šroubení
H Tömlovég csaphoz
RO Mufă pt. robinet cu file interior
F Raccord
I Collegamento al rubinetto
E Tubuladura de grifo
CN 铁箍接头

3/4"
19mm
1"
25mm
ABS



TIED ON CARD

YATO	size / rozmiar	
YT-8974	3/4"; 1" 19.0; 25.0 mm	12/120

GB Snap-in tap adaptor
D Wasserhahnanschluss für Gartenschlauch
PL Przyłącze do kranu
RUSAдаптер внутренний
CZ Šroubení
H Tömlovég csaphoz
RO Mufă pt. robinet cu file interior
F Raccord
I Collegamento al rubinetto
E Tubuladura de grifo
CN 铁箍接头

3/4"
19mm
1"
25mm
ABS



TIED ON CARD

YATO	size / rozmiar	
YT-99815	3/4"; 1" 19.0; 25.0 mm	12/120

GB Snap-in tap adaptor
D Wasserhahnanschluss für Gartenschlauch
PL Przyłącze do kranu
RUSAдаптер внутренний
CZ Šroubení
H Tömlovég csaphoz
RO Mufă pt. robinet cu file interior
F Raccord
I Collegamento al rubinetto
E Tubuladura de grifo
CN 铁箍接头

3/4"
19mm
ABS



TIED ON CARD

YATO	size / rozmiar	
YT-8975	3/4" 19.0 mm	24/240

GB 2 way coupling
D Schlauchkupplung
PL Złącze typu „I”
RUSСоединитель шлангов
CZ Spojka
H „I” típusú csőtoldó idom
RO Prelungitor furtun apă
F Connecteur type „I”
I Connettore tipo „I”
E Junta tipo „I”
CN 双向水管接头

ABS



TIED ON CARD

YATO	size / rozmiar	
YT-8976		24/240

GB 3 way coupling
D Drei wege kupplung
PL Rozdzielacz typu „Y”
RUSТройник для шлангов
CZ Y-kus
H „Y” típusú elágazás
RO Distributor 3 căi
F Dérivation type „Y”
I Connettore tipo „Y”
E Distribuidor tipo „Y”
CN 三向水管接头

ABS



TIED ON CARD

YATO	size / rozmiar	
YT-8977		24/240

GB Y-switch coupling with swivel
D 2-Wege Ventil
PL Rozdzielacz z zaworami
RUSРаспределитель внешний
CZ Rozbočovač s uzavíracími ventily
H Y-elágazó, 2 db külső menetes elzáróval
RO Racord iny cu robinet
F Dérivation type „Y”
I Distributore con valvole
E Distribuidor tipo „Y”
CN 双通水管转换接头

1/2"
12.5mm
ABS



TIED ON CARD

YATO	size / rozmiar	
YT-8978	1/2" 12.5 mm	24/240

GB One way tap adaptor
D Garten-Ventil
PL Zawór ogrodowy
RUSВентиль
CZ Ventil
H Szelep
RO Robinet
F Raccord régulateur
I Valvola giardino
E Válvula
CN 接头

3/4"
19mm
BRASS
MOSIADZ
AI
ABS



TIED ON CARD

YATO	size / rozmiar	
YT-9940	3/4" 19.0 mm	12/48

GB Y-switch coupling with swivel
D 2-Wege Ventil
PL Rozdzielacz z zaworami
RUSРаспределитель внешний
CZ Rozbočovač s uzavíracími ventily
H Y-elágazó, 2 db külső menetes elzáróval
RO Racord iny cu robinet
F Soupape double
I Distributore con valvole
E Distribuidor tipo „Y”
CN 两用转换接头

3/4"
19mm
1"
25mm
ABS



TIED ON CARD

YATO	size / rozmiar	
YT-99848	3/4"; 1" 19.0; 25.0 mm	12/48

GB Y-switch coupling with swivel
D 2-Wege Ventil
PL Rozdzielacz z zaworami
RUSРаспределитель внешний
CZ Rozbočovač s uzavíracími ventily
H Y-elágazó, 2 db külső menetes elzáróval
RO Racord iny cu robinet
F Raccord régulateur double
I Distributore con valvole
E Distribuidor tipo „Y”
CN 两用转换接头

3/4"
19mm
BRASS
MOSIADZ
AI
ABS



TIED ON CARD

YATO	size / rozmiar	
YT-9941	3/4" 19.0 mm	12/48

GB Adjustable spray nozzle
 D Spritze
 PL Zraszacz prosty regulowany
 RUS Распылитель поливочный
 CZ Postřikovač
 H Szórófej
 RO Stropitor apă

F Pistolet d'arrosage droit et réglé
 I Semplice sprinkler regolabile
 E Rociador
 CN 铝合金调节式水枪



TIED ON CARD

YATO
 YT-8950 12/48

GB Adjustable spray nozzle
 D Spritze
 PL Zraszacz prosty regulowany
 RUS Распылитель поливочный
 CZ Postřikovač
 H Szórófej
 RO Stropitor apă

F Pistolet d'arrosage droit et réglé
 I Semplice sprinkler regolabile
 E Rociador
 CN 铝合金调节式水枪



TIED ON CARD

YATO
 YT-99830 12/120

GB Adjustable spray gun
 D Regelbare Sprühpistole
 PL Pistolet zraszający regulowany
 RUS Регулируемый оросительный пистолет
 CZ Kropící pistole regulovatelná

H Öntöző pisztoly, állítható sugarú
 RO Pistolet de irigare ajustabil
 F Pistolet d'arrosage réglé
 I Pistola a spruzzo regolabile
 E Pistola rociadora ajustable
 CN 调节式水枪

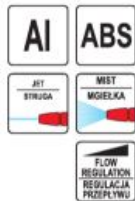

TIED ON CARD



YATO
 YT-8965 12/48

GB Adjustable spray gun
 D Regelbare Sprühpistole
 PL Pistolet zraszający regulowany
 RUS Регулируемый оросительный пистолет
 CZ Kropící pistole regulovatelná

H Öntöző pisztoly, állítható sugarú
 RO Pistolet de irigare ajustabil
 F Pistolet d'arrosage réglé
 I Pistola a spruzzo regolabile
 E Pistola rociadora ajustable
 CN 调节式水枪

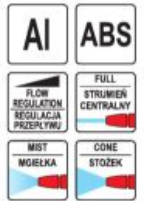

TIED ON CARD



YATO
 YT-8955 12/48

GB Adjustable spray gun
 D Regelbare Sprühpistole
 PL Pistolet zraszający regulowany
 RUS Регулируемый оросительный пистолет
 CZ Kropící pistole regulovatelná

H Öntöző pisztoly, állítható sugarú
 RO Pistolet de irigare ajustabil
 F Pistolet d'arrosage réglé
 I Pistola a spruzzo regolabile
 E Pistola rociadora ajustable
 CN 调节式水枪

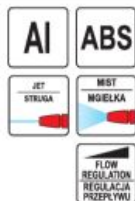

TIED ON CARD



YATO
 YT-8966 12/48

GB Adjustable spray gun
 D Regelbare Sprühpistole
 PL Pistolet zraszający regulowany
 RUS Регулируемый оросительный пистолет
 CZ Kropící pistole regulovatelná

H Öntöző pisztoly, állítható sugarú
 RO Pistolet de irigare ajustabil
 F Pistolet d'arrosage réglé
 I Pistola a spruzzo regolabile
 E Pistola rociadora ajustable
 CN 调节式水枪



TIED ON CARD



YATO
 YT-8956 12/48

GB Adjustable spray gun
D Regelbare Sprühpistole
PL Pistolet zraszający regulowany
RUSРегулируемый оросительный пистолет
CZ Kropící pistole regulovatelná

H Öntöző pisztoly, állítható sugarú
RO Pistolet de irigare ajustabil
F Pistolet d'arrosage réglé
I Pistola a spruzzo regolabile
E Pistola rociadora ajustable
CN 调节式水枪

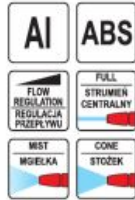

TIED ON CARD



YATO
YT-8957 12/48

GB Adjustable spray gun
D Regelbare Sprühpistole
PL Pistolet zraszający regulowany
RUSРегулируемый оросительный пистолет
CZ Kropící pistole regulovatelná
H Öntöző pisztoly, állítható sugarú

RO Pistolet de irigare ajustabil
F Pistolet d'arrosage réglé
I Pistola a spruzzo regolabile
E Pistola rociadora ajustable
CN 调节式水枪



TIED ON CARD



YATO
YT-8967 12

GB Multifunction sprinkling gun
D Multifunktions-Spritzpistole
PL Wielofunkcyjny pistolet zraszający
RUSМногофункциональный оросительный пистолет
CZ Multifunkční postřikovací pistole
H Többfunkciós öntöző pisztoly

RO Pistol multifuncțional pt. pulverizare
F Pistolet d'arrosage
I Multifunzione pistola a spruzzo
E Pistola para regar multifuncional
CN 六用途调节式水枪



TIED ON CARD



YATO
YT-8958 12/48

GB Multifunction sprinkling gun
D Multifunktions-Spritzpistole
PL Wielofunkcyjny pistolet zraszający
RUSМногофункциональный оросительный пистолет
CZ Multifunkční postřikovací pistole
H Többfunkciós öntöző pisztoly

RO Pistol multifuncțional pt. pulverizare
F Pistolet d'arrosage
I Multifunzione pistola a spruzzo
E Pistola para regar multifuncional
CN 六用途调节式水枪



TIED ON CARD



YATO
YT-8964 12/48

GB Multifunction sprinkling gun
D Multifunktions-Spritzpistole
PL Wielofunkcyjny pistolet zraszający
RUSМногофункциональный оросительный пистолет
CZ Multifunkční postřikovací pistole
H Többfunkciós öntöző pisztoly

RO Pistol multifuncțional pt. pulverizare
F Pistolet d'arrosage
I Multifunzione pistola a spruzzo
E Pistola para regar multifuncional
CN 六用途调节式水枪



TIED ON CARD



YATO
YT-8963 12/48

GB Multifunction sprinkling gun
D Multifunktions-Spritzpistole
PL Wielofunkcyjny pistolet zraszający
RUSМногофункциональный оросительный пистолет
CZ Multifunkční postřikovací pistole
H Többfunkciós öntöző pisztoly

RO Pistol multifuncțional pt. pulverizare
F Pistolet d'arrosage
I Multifunzione pistola a spruzzo
E Pistola para regar multifuncional
CN 六用途调节式水枪



TIED ON CARD



YATO
YT-8959 12/48

GB Multifunction sprinkling gun
 D Multifunktions-Spritzpistole
 PL Wielofunkcyjny pistolet zraszający
 RUS Многофункциональный оросительный пистолет
 CZ Multifunkční postřikovací pistole
 H Többfunkciós öntöző pisztoly

RO Pistol multifuncțional pt. pulverizare
 F Pistolet d'arrosage
 I Multifunzione pistola a spruzzo
 E Pistola para regar multifuncional
 CN 六用途调节式水枪



TIED ON CARD



YATO size / rozmiar
 YT-8960 12/48

GB Multifunction sprinkling gun
 D Multifunktions-Spritzpistole
 PL Wielofunkcyjny pistolet zraszający
 RUS Многофункциональный оросительный пистолет
 CZ Multifunkční postřikovací pistole
 H Többfunkciós öntöző pisztoly

RO Pistol multifuncțional pt. pulverizare
 F Pistolet d'arrosage
 I Multifunzione pistola a spruzzo
 E Pistola para regar multifuncional
 CN 六用途调节式水枪



TIED ON CARD



YATO size / rozmiar
 YT-99841 12/48

GB Multifunction sprinkling gun
 D Multifunktions-Spritzpistole
 PL Wielofunkcyjny pistolet zraszający
 RUS Многофункциональный оросительный пистолет
 CZ Multifunkční postřikovací pistole
 H Többfunkciós öntöző pisztoly

RO Pistol multifuncțional pt. pulverizare
 F Pistolet d'arrosage
 I Multifunzione pistola a spruzzo
 E Pistola para regar multifuncional
 CN 六用途调节式水枪



TIED ON CARD



YATO size / rozmiar
 YT-8968 12

GB Basic hose set with straight nozzle
 D Bewässerungs Spritz und Anschlussset
 PL Zestaw złączek ze zraszaczem prostym
 RUS Набор поливочный
 CZ Postřikovač + spojky
 H Készlet gyorskapoccsal csaphoz
 RO Ștut furtun apă cu accesorii pt. robinet
 F Set d'arrosage raccord
 I Set raccordi con sprinkler semplice
 E Juego de rociar tubuladura de grifo
 CN 水枪组套



BLISTER CARD



YATO size / rozmiar
 YT-99831 1/2"; 3/4" 12.5; 19.0 mm 48

GB Basic hose set with straight nozzle
 D Bewässerungs Spritz und Anschlussset
 PL Zestaw złączek ze zraszaczem prostym
 RUS Набор поливочный
 CZ Postřikovač + spojky
 H Készlet gyorskapoccsal csaphoz
 RO Ștut furtun apă cu accesorii pt. robinet
 F Set d'arrosage raccord
 I Set raccordi con sprinkler semplice
 E Juego de rociar tubuladura de grifo
 CN 水枪组套



BLISTER CARD



YATO size / rozmiar
 YT-99832 3/4"; 1" 19.0; 25.0 mm 48

GB Impulse sprinkler
D Impulssprenger
PL Zraszacz impulsowy
RUS Распылитель импульсный на пике
CZ Postřikovač
H Impulzus szórófej
RO Stropitor apă
F Arroseur impulsion sur piquet
I Sprinkler impulso
E Rociador
CN 脉冲洒水器

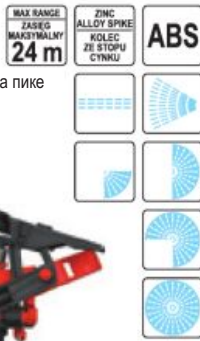

TIED
ON CARD



YATO

YT-8985



48

GB Impulse sprinkler
D Impulssprenger
PL Zraszacz impulsowy
RUS Распылитель импульсный на пике
CZ Postřikovač
H Impulzus szórófej
RO Stropitor apă
F Arroseur impulsion sur piquet
I Sprinkler impulso
E Rociador
CN 脉冲洒水器

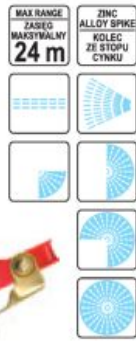

TIED
ON CARD



YATO

YT-8986



48

GB 3-arms revolving sprinkler
D 3-Arm Kreis-Regner
PL Zraszacz 3-ramienny
RUS трехсторонний вращающийся распылитель на пике
CZ Rozprařovač třiramenný
H Locsoló, leszúrható, forgó
RO Aspersol cu 3 brate
F Arroseur sur piquet 3 branches
I Tre braccio sprinkler
E Rociador 3-brazos
CN 三叉插针洒水器



TIED
ON CARD



YATO

YT-8987



48

GB Tripod impulse sprinkler
D Impulssprenger
PL Zraszacz impulsowy na statywie
RUS Распылитель импульсный на подставке
CZ Postřikovač
H Impulzus szórófej
RO Stropitor apă
F Arroseur impulsion lance
I Sprinkler impulso su un treppiede
E Rociador
CN 洒水器

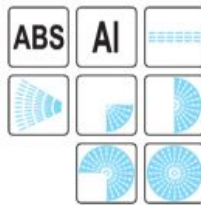

COLOR BOX

YATO

YT-8984



12

GB 8 pattern sprinkler
D 8-Flächenregner
PL Zraszacz 8-funkcyjny
RUS Распылитель 8-позиционный на подставке
CZ Postrikovač
H 8 funkciós szórófej
RO Stropitor apă cu 8 duze
F Turbine d'arrosage 8 fonctionnes
I Sprinkler 8-funzioni
E Rociador 8-funciones de tierra
CN 洒水器

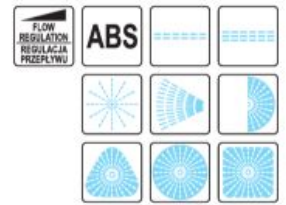

TIED
ON CARD



YATO

YT-8991



48

GB Aluminium tube oscillating sprinkler
D Viereckregner
PL Zraszacz oscylacyjny z rurką aluminiową
RUS Распылитель осциллирующий
CZ Postrikovač
H Oszillációs szórófej
RO Stropitor apă
F Arroseur oscillant aluminium
I Oscillante sprinkler con tubo di alluminio
E Rociador giratorio con tubo de aluminio
CN 摇摆洒水器

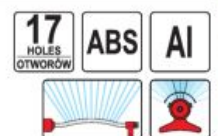

COLOR BOX

YATO

YT-8993



6

GB Tube oscillating sprinkler
 D Viereckregner
 PL Zraszacz oscylacyjny
 RUS Распылитель осциллирующий
 CZ Postríkovač
 H Oszillációs szórófej
 RO Stropitor apă
 F Arroseur oscillant
 I Oscillante sprinkler
 E Rociador giratorio
 CN 摇摆洒水器



COLOR BOX

YATO
 YT-99845 6

GB Hose holder
 D Gartenschlauchträger
 PL Stojak do węży ogrodowego
 RUS Барабан для намотки поливочного шланга
 CZ Stojan navijecí na zahradní hadici
 H Utartódob locsolótömlőhöz
 RO Suport pt. furtun
 F Dévidoir sur roues
 I Carrello avvolgitubo
 E Estante para manguera de jardín
 CN 卷线盘

ø 3/4" (19 mm)
 45 m

ø 1/2" (12.5 mm)
 50 m

PP



COLOR BOX



YATO	hose size / rozmiar węży (m)	
YT-99850	3/4" (19.0 mm) / 45 m 1/2" (12.5 mm) / 50 m	2

GB Hose holder
 D Gartenschlauchträger
 PL Stojak do węży ogrodowego
 RUS Барабан для намотки поливочного шланга
 CZ Stojan navijecí na zahradní hadici
 H Utartódob locsolótömlőhöz
 RO Suport pt. furtun
 F Dévidoir sur roues
 I Carrello avvolgitubo
 E Estante para manguera de jardín
 CN 卷线盘

ø 3/4" (19 mm)
 45 m

ø 1/2" (12.5 mm)
 50 m

PP



COLOR BOX



YATO	hose size / rozmiar węży (m)	
YT-99852	3/4" (19.0 mm) / 45 m 1/2" (12.5 mm) / 50 m	2

GB Hose holder
 D Gartenschlauchträger
 PL Stojak do węży ogrodowego
 RUS Барабан для намотки поливочного шланга
 CZ Stojan navijecí na zahradní hadici
 H Utartódob locsolótömlőhöz
 RO Suport pt. furtun
 F Dévidoir sur roues
 I Carrello avvolgitubo
 E Estante para manguera de jardín
 CN 卷线盘

ø 3/4" (19 mm)
 50 m

ø 1/2" (12.5 mm)
 100 m

PP



COLOR BOX



YATO	hose size / rozmiar węży (m)	
YT-99853	3/4" (19.0 mm) / 50 m 1/2" (12.5 mm) / 100 m	2

GB Submersible pump for dirty water and wastewater
 D Tauchpumpe für Schmutzwasser
 PL Pompa zatapialna do wody brudnej i ścieków
 RUS Погружной насос для грязной воды
 CZ Ponorné čerpadlo pro odpadní vody
 H Bűvárszivattyú szennyvíz
 RO Pompă submersibilă pt. apă uzată
 F Pompe submersible pour eaux usees
 I Pompa sommersa per acque reflue
 E Bomba sumergible para aguas residuales
 CN 污水和废水的潜水泵



COLOR BOX



230V~50Hz 750 W Q max 16000 l/h



Δ [m]	Q [l/h]
0	16000
1	15000
2	14000
3	13500
4	12500
5	11500
6	11000
7	10500
8	9500
9	8000
10	5500
11	3500
12	2000
13	500

YATO	W	l / h	H (max)	
YT-85350	750	16000	13	1

GB By-pass pruner
D Rebenschere
PL Sekator uniwersalny
RUS Cекатор
CZ Nožnice zahradnicke
H Metszoolló

RO Foarfece pt. pomi
F Sécateur traditionnel
I Cesioie universale
E Podadera universal
CN 剪枝剪



205 mm



TRY ME
HALF BLISTER
CARD

YATO	L (mm)	
YT-8800	205	12/72

mid carbon steel blades

GB By-pass pruner
D Rebenschere
PL Sekator uniwersalny
RUS Cекатор
CZ Nožnice zahradnicke
H Metszoolló

RO Foarfece pt. pomi
F Sécateur traditionnel
I Cesioie universale
E Podadera universal
CN 剪枝剪



220 mm
PTFE COATED
POWLEKANE



TRY ME
HALF BLISTER
CARD

YATO	L (mm)	
YT-8801	220	12/72

high carbon steel blades

GB Professional anvil pruner
D Amboss-Gartenschere
PL Sekator kowadełkowy
RUS Cекатор
CZ Nožnice zahradnicke
H Metszoolló

RO Foarfece pt. pomi
F Sécateur à enclume
I Cesioie anvil
E Podadera
de bigornia
CN 棘轮剪枝剪



200 mm
PTFE COATED
POWLEKANE



TRY ME
HALF BLISTER
CARD

YATO	L (mm)	
YT-8802	200	12/72

high carbon steel blades

GB By-pass pruner
D Rebenschere
PL Sekator uniwersalny
RUS Cекатор
CZ Nožnice zahradnicke
H Metszoolló

RO Foarfece pt. pomi
F Sécateur traditionnel
I Cesioie universale
E Podadera universal
CN 剪枝剪



180 mm
PTFE COATED
POWLEKANE



TRY ME
HALF BLISTER
CARD

YATO	L (mm)	
YT-8805	180	12/72

high carbon steel blades

GB Ratchet by-pass pruner
D Gartenschere
PL Sekator z grzechotką
RUS Cекатор
CZ Nožnice zahradnicke
H Metszoolló

RO Foarfece pt. pomi
F Sécateur à cliquet
I Cesioie con cricchetto
E Podadera
con carraca
CN 棘轮剪枝剪



200 mm
SK5
PTFE COATED
POWLEKANE



TRY ME
HALF BLISTER
CARD

YATO	L (mm)	
YT-8807	200	12/72

GB Ratchet by-pass pruner
D Gartenschere
PL Sekator z grzechotką
RUS Cекатор
CZ Nožnice zahradnicke
H Metszoolló

RO Foarfece pt. pomi
F Sécateur à cliquet
I Cesioie con cricchetto
E Podadera
con carraca
CN 棘轮剪枝剪



200 mm
SK5
PTFE COATED
POWLEKANE



TRY ME
HALF BLISTER
CARD

YATO	L (mm)	
YT-8808	200	12/72

GB Professional anvil pruner
D Amboss-Gartenschere
PL Sekator kowadełkowy
RUS Cекатор
CZ Nožnice zahradnicke
H Metszoolló

RO Foarfece pt. pomi
F Sécateur à enclume
I Cesioie anvil
E Podadera
de bigornia
CN 棘轮剪枝剪



210 mm
SK5
PTFE COATED
POWLEKANE



TRY ME
HALF BLISTER
CARD

YATO	L (mm)	
YT-8809	210	12/72

high carbon steel blades

GB By-pass pruner
D Rebenschere
PL Sekator uniwersalny
RUS Cекатор
CZ Nožnice zahradnicke
H Metszoolló

RO Foarfece pt. pomi
F Sécateur traditionnel
I Cesioie universale
E Podadera universal
CN 剪枝剪



190 mm
SK5
PTFE COATED
POWLEKANE



TRY ME
HALF BLISTER
CARD

YATO	L (mm)	
YT-8811	190	12/72

high carbon steel blades

GB By-pass pruner
D Rebschere
PL Sekator uniwersalny
RUSСекатор
CZ Nožnice zahradnicke
H Metszoolló

RO Foarfece pt. pomi
F Sécateur traditionnel
I Cesioie universale
E Podadera universal
CN 剪枝剪



TRY ME
HALF BLISTER
CARD

YATO	L (mm)	
YT-8845	200	12/72

GB By-pass pruner
D Rebschere
PL Sekator uniwersalny
RUSСекатор
CZ Nožnice zahradnicke
H Metszoolló

RO Foarfece pt. pomi
F Sécateur traditionnel
I Cesioie universale
E Podadera universal
CN 剪枝剪



SLIDING
CARD

YATO	L (mm)	
YT-8790	200	12/60

GB Fruit and flower shears
D Blumen- und Rebschere
PL Sekator do obcinania zawiązków
RUSСекатор
CZ Nožnice zahradnicke
H Metszoolló

RO Foarfece pt. pomi
F Sécateur
I Cesioia taglio gemme
E Podadera para cortar germenos
CN 花枝剪



SLIDING
CARD

YATO	L (mm)	
YT-8791	200	12/60

GB Fruit and flower shears
D Blumen- und Rebschere
PL Sekator do obcinania zawiązków
RUSСекатор
CZ Nožnice zahradnicke
H Metszoolló

RO Foarfece pt. pomi
F Sécateur
I Cesioia taglio gemme
E Podadera para cortar germenos
CN 花枝剪



SLIDING
CARD

YATO	L (mm)	
YT-8815	180	12/72

GB Fruit and flower shears
D Blumen- und Rebschere
PL Sekator do obcinania zawiązków
RUSСекатор
CZ Nožnice zahradnicke
H Metszoolló

RO Foarfece pt. pomi
F Sécateur
I Cesioia taglio gemme
E Podadera para cortar germenos
CN 花枝剪



SLIDING
CARD

YATO	L (mm)	
YT-8816	190	12/72

GB Fruit and flower shears
D Blumen- und Rebschere
PL Sekator do obcinania zawiązków
RUSСекатор
CZ Nožnice zahradnicke
H Metszoolló

RO Foarfece pt. pomi
F Sécateur
I Cesioia taglio gemme
E Podadera para cortar germenos
CN 花枝剪



SLIDING
CARD

YATO	L (mm)	
YT-8817	190	12/72

GB By-pass pruner
D Rebschere
PL Sekator uniwersalny
RUSСекатор
CZ Nožnice zahradnicke
H Metszoolló

RO Foarfece pt. pomi
F Sécateur traditionnel
I Cesioie universale
E Podadera universal
CN 剪枝剪



TRY ME
HALF BLISTER
CARD

YATO	L (mm)	
YT-8843	180	5/60

GB By-pass pruner
D Rebschere
PL Sekator uniwersalny
RUSСекатор
CZ Nožnice zahradnicke
H Metszoolló

RO Foarfece pt. pomi
F Sécateur traditionnel
I Cesioie universale
E Podadera universal
CN 剪枝剪



TRY ME
HALF BLISTER
CARD

YATO	L (mm)	
YT-8849	200	12/72

GB By-pass lopping shears
D Astschere
PL Sekator do gałęzi
RUSСучкорез
CZ Nožnice zahradnicke
H Ágvágó fix
RO Foarfeca curbata pt. taiat crengi

F Coupe-branches à lame franche
I Cesoia tagliarami
E Podadera para ramas
CN 高枝剪



HANGING CARD & POUCH ON BLADE

YATO	L (mm)	
YT-8831	625	12

1050 mid carbon steel blades

GB Anvil lopping shears
D Amboss Astschere
PL Sekator kowadełkowy do gałęzi
RUSСучкорез
CZ Nožnice zahradnicke
H Ágvágó fix
RO Foarfeca curbata pt. taiat crengi

F Coupe-branches à éclume
I Cesoia anvil tagliarami
E Podadera para ramas, de bigornia
CN 高枝剪



HANGING CARD & POUCH ON BLADE

YATO	L (mm)	
YT-8832	635	12

1050 mid carbon steel blades

GB By-pass lopping shears
D Astschere
PL Sekator do gałęzi
RUSСучкорез
CZ Nožnice zahradnicke
H Ágvágó fix
RO Foarfeca curbata pt. taiat crengi

F Coupe-branches à lame franche
I Cesoia tagliarami
E Podadera para ramas
CN 高枝剪



HANGING CARD & POUCH ON BLADE

YATO	L (mm)	
YT-8833	705	12

1050 mid carbon steel blades

GB Anvil lopping shears
D Amboss Astschere
PL Sekator kowadełkowy do gałęzi
RUSСучкорез
CZ Nožnice zahradnicke
H Ágvágó fix
RO Foarfeca curbata pt. taiat crengi

F Coupe-branches à éclume
I Cesoia anvil tagliarami
E Podadera para ramas, de bigornia
CN 高枝剪



HANGING CARD & POUCH ON BLADE

YATO	L (mm)	
YT-8834	700	12

1050 mid carbon steel blades

GB By-pass lopping shears
D Astschere
PL Sekator do gałęzi
RUSСучкорез
CZ Nožnice zahradnicke
H Ágvágó fix
RO Foarfeca curbata pt. taiat crengi

F Coupe-branches à lame franche
I Cesoia tagliarami
E Podadera para ramas
CN 高枝剪



HANGING CARD & POUCH ON BLADE

YATO	L (mm)	
YT-8835	780	12

1050 mid carbon steel blades

GB Anvil lopping shears
D Amboss Astschere
PL Sekator kowadełkowy do gałęzi
RUSСучкорез
CZ Nožnice zahradnicke
H Ágvágó fix
RO Foarfeca curbata pt. taiat crengi

F Coupe-branches à éclume
I Cesoia anvil tagliarami
E Podadera para ramas, de bigornia
CN 高枝剪



HANGING CARD & POUCH ON BLADE

YATO	L (mm)	
YT-8836	770	12

1050 mid carbon steel blades

GB Telescopic by-pass lopping shears
D Astschere
PL Sekator teleskopowy do gałęzi
RUSСекатор с телескопическими ручками
CZ Nožnice zahradnicke
H Ágvágó teleszkópos
RO Foarfeca curbata pt. taiat crengi
F Coupe-branches télescopique
I Cesoie tagliarami telescopica
E Podadera telescópica para ramas
CN 可伸缩高枝剪



HANGING CARD & POUCH ON BLADE

YATO	L (mm)	
YT-8838	630-960	6/12

mid carbon steel blades

GB Telescopic by-pass lopping shears
 D Astschere
 PL Sekator teleskopowy do gałęzi
 RUS Секатор с телескопическими ручками
 CZ Nožnice zahradnicke
 H Ágvágó teleszkópos

RO Foarfeca curbata pt. taiat crengi
 F Coupe-branches télescopique
 I Cesoie tagliarami telescopica
 E Podadera telescópica para ramas
 CN 可伸缩高枝剪



HANGING CARD & POUCH ON BLADE

YATO	L (mm)	
YT-8839	650-900	6

GB Telescopic by-pass lopping shears
 D Astschere
 PL Sekator teleskopowy do gałęzi
 RUS Секатор с телескопическими ручками
 CZ Nožnice zahradnicke
 H Ágvágó teleszkópos

RO Foarfeca curbata pt. taiat crengi
 F Coupe-branches télescopique
 I Cesoie tagliarami telescopica
 E Podadera telescópica para ramas
 CN 可伸缩高枝剪



HANGING CARD & POUCH ON BLADE

YATO	L (mm)	
YT-8840	640-885	12

GB Telescopic by-pass lopping shears
 D Astschere
 PL Sekator teleskopowy do gałęzi
 RUS Секатор с телескопическими ручками
 CZ Nožnice zahradnicke
 H Ágvágó teleszkópos

RO Foarfeca curbata pt. taiat crengi
 F Coupe-branches télescopique
 I Cesoie tagliarami telescopica
 E Podadera telescópica para ramas
 CN 可伸缩高枝剪



HANGING CARD & POUCH ON BLADE

YATO	L (mm)	
YT-8841	690-930	6

GB Telescopic by-pass lopping shears
 D Astschere
 PL Sekator teleskopowy do gałęzi
 RUS Секатор с телескопическими ручками
 CZ Nožnice zahradnicke
 H Ágvágó teleszkópos

RO Foarfeca curbata pt. taiat crengi
 F Coupe-branches télescopique
 I Cesoie tagliarami telescopica
 E Podadera telescópica para ramas
 CN 可伸缩高枝剪



HANGING CARD & POUCH ON BLADE

YATO	L (mm)	
YT-8842	660-910	12

GB Leverage tree pruner
 D Baumsäge mit astschere
 PL Sekator gašienicowy z piłą
 RUS Сучкорез штанговый с пилой
 CZ Střiháč na větve s pilovým listem
 H Kóteles ágvágó
 RO Fierastrau pt. pomii cu prelungitor
 F Système de scie à poulie
 I Taglio pista con sega
 E Podadera de palanca con sierra
 CN 高枝锯



DOUBLE BLISTER

YATO	L (mm)	
YT-8876	325	12

GB Hedge shears
D Heckenschere
PL Nożyce do żywopłotu
RUSКусторезы
CZ Nožnice na živý plot
H Sónvényvágó olló

RO Foarfeca pt. gard viu
F Cisaille à haie
I Cesioie per le siepe
E Tijeras para seto vivo
CN 整篱剪

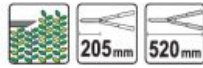

HANGING CARD & POUCH ON BLADE

YATO	L (mm)	
YT-8821	520	24

1050 mid carbon steel blades

GB Hedge shears
D Heckenschere
PL Nożyce do żywopłotu
RUSКусторезы
CZ Nožnice na živý plot
H Sónvényvágó olló
RO Foarfeca pt. gard viu

F Cisaille à haie
I Cesioie per le siepe
E Tijeras para seto vivo
CN 整篱剪



HANGING CARD & POUCH ON BLADE

YATO	L (mm)	
YT-8822	550	12

1050 mid carbon steel blades

GB Hedge shears
D Heckenschere
PL Nożyce do żywopłotu
RUSКусторезы
CZ Nožnice na živý plot
H Sónvényvágó olló

RO Foarfeca pt. gard viu
F Cisaille à haie
I Cesioie per le siepe
E Tijeras para seto vivo
CN 整篱剪



HANGING CARD & POUCH ON BLADE

YATO	L (mm)	
YT-8823	650	12

1050 mid carbon steel blades

GB Telescopic hedge shears
D Heckenschere
PL Teleskopowe nożyce do żywopłotu
RUSКусторезы с телескопическими ручками
CZ Nožnice na živý plot
H Sónvényvágó olló

RO Foarfeca pt. gard viu
F Cisaille télescopique à haie
I Cesioie telescopiche per siepe
E Tijeras para seto vivo
CN 可伸缩整篱剪



HANGING CARD & POUCH ON BLADE

YATO	L (mm)	
YT-8824	690-890	6

50 mid carbon steel blades

GB Grass shears
D Handgrassschere
PL Nożyce do trawy wielopozycyjne
RUSНожницы для стрижки травы
CZ Nožnice na trávu
H Forgatható fűviró olló

RO Foarfeca pt. gazon
F Cisaille à gazon
I Cesioie per erba multifunzione
E Tijeras de cesped
CN 草剪

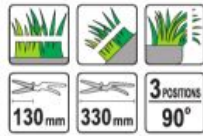

TRY ME HALF BLISTER CARD

YATO	L (mm)	
YT-8851	330	12/60

1050 mid carbon steel blades

GB Grass shears
D Handgrassschere
PL Nożyce do trawy wielopozycyjne
RUSНожницы для стрижки травы
CZ Nožnice na trávu
H Forgatható fűviró olló

RO Foarfeca pt. gazon
F Cisaille à gazon
I Cesioie per erba multifunzione
E Tijeras de cesped
CN 草剪

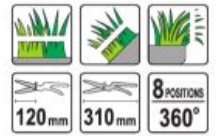

TRY ME HALF BLISTER CARD

YATO	L (mm)	
YT-8852	310	6/24

1050 mid carbon steel blades

GB Grass shears
D Handgrassschere
PL Nożyce do trawy wielopozycyjne
RUSНожницы для стрижки травы
CZ Nožnice na trávu
H Forgatható fűviró olló

RO Foarfeca pt. gazon
F Cisaille à gazon
I Cesioie per erba multifunzione
E Tijeras de cesped
CN 草剪

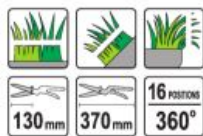

TRY ME HALF BLISTER CARD

YATO	L (mm)	
YT-8853	370	6/72

1050 mid carbon steel blades

GB Grass shears
D Handgrassschere
PL Nożyce do trawy wielopozycyjne
RUSНожницы для стрижки травы
CZ Nožnice na trávu
H Forgatható fűviró olló

RO Foarfeca pt. gazon
F Cisaille à gazon
I Cesioie per erba multifunzione
E Tijeras de cesped
CN 草剪

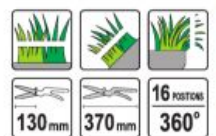

TRY ME HALF BLISTER CARD

YATO	L (mm)	
YT-8854	370	6/72

1050 mid carbon steel blades

GB Bow saw
D Bùgelsàge
PL Pila kablàkowa
RUS Лучковая пила
CZ Oblouková pila
H Keretes fùrész

RO Feràstràu de curburà
F Scie à bùches
I Segà ad arco
E Sierra de arco
CN 两用弓锯

COLOR SLEEVE



HCS 65



YATO	L (mm)	
YT-3200	300	12/24



YATO	L (mm)	
YT-3201	450	12/24
YT-3202	530	
YT-3203	610	
YT-3204	760	

GB Blade for dry wood
D Trockenholzsàgeblatt für Handsàge
PL Brzeszczot do drewna suchego
RUS Лезвие для работы по сухому дереву
CZ Pilový list na suché dřevo

H Fùrészlap szàraz fához
RO Lama pt. lemn uscat
F Lame à bois sec
I Lama per il legno secco
E Hoja de sierra para madera seca
CN 干木锯条

HCS 65



COLOR SLEEVE

YATO	L (mm)	
YT-3221	450	50/200
YT-3222	530	
YT-3223	610	
YT-3224	760	

GB Blade for wet wood
D Nassholzsàgeblatt für Handsàge
PL Brzeszczot do drewna mokrego
RUS Лезвие для работы по влажному дереву
CZ Pilový list na mokré dřevo

H Fùrészlap nedves fához
RO Lama pt. lemn verde
F Lame à bois humide
I Lama per il legno bagnato
E Hoja de sierra para madera mojada
CN 湿木锯条

HCS 65



COLOR SLEEVE

YATO	L (mm)	
YT-3230	300	50/200
YT-3231	450	
YT-3232	530	
YT-3233	610	
YT-3234	760	

GB Axe
D Beil Hicorystiel
PL Siekiera

RUS Tonop
CZ Sekerka
H Szekerce

RO Secure
F Hache
I Ascìa

E Hacha
CN 把斧

DIN 5131 7294

GENUINE HICKORY

Timber wedge and steel ring
Drewniany klin ze stalowym pierścieniem

Genuine hickory shaft
Trzonek z hickory



Forged carbon steel head hardened and tempered
Głowica z kutej stali węglowej, hartowana i utwardzona

YATO	m (g)	L (mm)	DIN	
YT-8001	600	360	5131	24
YT-8002	800	380	5131	20
YT-8003	1000	430	5131	12
YT-8004	1250	710	7294	12
YT-8005	1400	710	7294	12
YT-8006	1600	810	7294	12

GB Axe
D Beil Hicorystiel
PL Siekiera

RUS Tonop
CZ Sekerka
H Szekerce

RO Secure
F Hache
I Ascìa

E Hacha
CN 把斧

GENUINE HICKORY

Timber wedge and steel ring
Drewniany klin ze stalowym pierścieniem

Genuine hickory shaft
Trzonek z hickory



Forged carbon steel head hardened and tempered
Głowica z kutej stali węglowej, hartowana i utwardzona

YATO	m (g)	L (mm)	
YT-8011	1000	515	6
YT-8012	2000	820	6

GB Transplanter
D Blumenkelle
PL Łopátka
RUSСовок посадочный
CZ Lopatka
H Ásó
RO Mini-lopată gradinarit
F Transplantoir
I Spatola
E Paleta estrecha
CN 移植器

350
mm

CARBON
STEEL



YATO	L (mm)	
YT-8865	350	10/60

GB Rake
D Blumenrechen
PL Grabki
RUSГрабли
CZ Hrabičky
H Gereblye
RO Mini grebla
F Râteau
I Rastrelli
E Rastrillo
CN 园艺耙

325
mm

CARBON
STEEL



YATO	L (mm)	
YT-8866	325	10/60

GB 3-tine fork & rake
D Kleinhacke
PL Motyczka + pazurki
RUSРыхлитель комбинированный
CZ Motyčka s kultivátorem
H Kapa és kultivátor
RO Sapaliga + cultivator
F Râteau et bêche
I Zappa + artigli
E Escarificador tres
dientes con azadilla
CN 园艺耙

310
mm

CARBON
STEEL



YATO	L (mm)	
YT-8867	310	10/60

GB Cultivator
D Grubber
PL Pazurki
RUSРыхлитель
CZ Kultivátor
H Kultivátor
RO Cultivator
F Griffes piocheuse
I Artigli
E Escarificador
CN 园艺耙

420
mm

CARBON
STEEL



YATO	L (mm)	
YT-8868	420	10/60

GB Garden rake
D Landschaftsbesen
PL Grabki wachlarzowe
RUSГрабли веерные
CZ Hrabičky
H Kerti gereblye
RO Grebla de gradina
F Râteau
I Rastrelli ventilatore
E Rastrillo de abanico
de hojalata
CN 园艺耙

400
mm

CARBON
STEEL



YATO	L (mm)	
YT-8869	400	10/60

GB Transplanter
D Blumenkelle
PL Łopátka
RUSСовок посадочный
CZ Lopatka
H Ásó
RO Mini-lopată gradinarit
F Transplantoir
I Spatola
E Paleta estrecha
CN 移植器

360
mm

CARBON
STEEL



YATO	L (mm)	
YT-8870	360	10/60

GB Transplanter
D Blumenkelle
PL Łopátka
RUSСовок посадочный
CZ Lopatka
H Ásó
RO Mini-lopată gradinarit
F Transplantoir
I Spatola
E Paleta estrecha
CN 移植器

340
mm

CHROME
PLATED



YATO	L (mm)	
YT-8885	340	12/72

GB Transplanter
D Blumenkelle
PL Łopátka
RUSСовок посадочный
CZ Lopatka
H Ásó
RO Mini-lopată gradinarit
F Transplantoir
I Spatola
E Paleta estrecha
CN 移植器

340
mm

CHROME
PLATED



YATO	L (mm)	
YT-8886	340	12/72

GB Hoe
D Garten handhacke
PL Motyczka
RUSМотыжка
CZ Motyčka
H Kerti kapa
RO Sapaliga
F Binette
I Zappetta
E Azadilla
CN 园艺锄

280
mm

CHROME
PLATED



YATO	L (mm)	
YT-8889	280	12/72

GB Cultivator
D Grubber
PL Pazurki
RUSРыхлитель
CZ Kultivátor
H Kultivátor
RO Cultivator
F Griffes piocheuse
I Artigli
E Escarificador
CN 园艺耙

270
mm

CHROME
PLATED



YATO	L (mm)	
YT-8890	270	12/72

GB Rolling tiller
D Rollpflüger
PL Spulchniaz
RUSРыхлитель дисковый
CZ Kypříč pudy
H Görgös talajlazító
RO Maruntitor pt. pamant
F Émietteur
I Coltivatore
E Escarificador
CN 松土器

370
mm

CHROME
PLATED



YATO	L (mm)	
YT-8891	370	12/72

GB Hoe + cultivator
D Kleinhacke
PL Motyczka z pazurkami
RUSРыхлитель
комбинированный
CZ Motyčka s hrabičkami
H Kerti villás kapa
RO Sapaliga + cultivator
F Serfouette
I Zappetta con artigli
E Azadilla con
escarificador
CN 园艺锄

320
mm

CHROME
PLATED



YATO	L (mm)	
YT-8892	320	12/72

- GB Dibble
- D Pflanzer
- PL Pikownik ogrodniczy
- RUS Конус посадочный с деревянной ручкой
- CZ Zahradnický přepichovač
- H Kerti palántázó
- RO Chitonag pt. grădină
- F Plantoir
- I Foraterra
- E Picadeor de jardin
- CN 挖洞器



280 mm

SS
STAINLESS STEEL
EN 10088-3

YATO	L (mm)	
YT-8894	280	10/60

- GB Spade
- D Rodespaten
- PL Szpadel
- RUS Заступ
- CZ Lisovaný rýč kalená
- H Ásó, sajtoló-edzett
- RO Hârleț cu coadă
- F Bêche à bord pointu
- I Spatola
- E Pala
- CN 铲



120 cm

HRC 40-48

1050Mn
STEEL

YATO	L (cm)	
YT-86804	120	6

- GB Spade
- D Rodespaten
- PL Szpadel
- RUS Заступ
- CZ Lisovaný rýč kalená
- H Ásó, sajtoló-edzett
- RO Hârleț cu coadă
- F Bêche à bord droit
- I Spatola
- E Pala
- CN 铲



120 cm

HRC 40-48

1050Mn
STEEL

YATO	L (cm)	
YT-86800	120	6

- GB Shovel
- D Schaufel
- PL Lopata
- RUS Лопата
- CZ Osazený rýč
- H Homoklapát, ékelt
- RO Lopată pt. nisip
- F Pelle à charbon
- I Palla
- E Pala
- CN 鏟子



120 cm

HRC 40-48

1050Mn
STEEL

YATO	L (cm)	
YT-86801	120	6

- GB Shovel
- D Schaufel
- PL Łopata ogrodnicza
- RUS Лопата совковая песочная
- CZ Osazený rýč pískový
- H Homoklapát, ékelt
- RO Lopată pt. nisip
- F Pelle à sable
- I Palla
- E Pala
- CN 鏟子



120 cm

HRC 40-48

1050Mn
STEEL

YATO	L (cm)	
YT-86808	120	6

- GB Digging fork
- D Profi-grabegabel
- PL Widły
- RUS Вилы
- CZ Zahradnické vidlice
- H Vasvilla
- RO Furcă pt. grădinărit
- F Fourche à bêche
- I Forchetta
- E Horca
- CN 铁叉



120 cm

YATO	L (cm)	
YT-86805	120	6

- GB Digging fork
- D Profi-grabegabel
- PL Widły
- RUS Вилы
- CZ Zahradnické vidlice
- H Vasvilla
- RO Furcă pt. grădinărit
- F Fourche à bêche
- I Forchetta
- E Horca
- CN 铁叉



120 cm

YATO	L (cm)	
YT-86809	120	6

- GB Cordless chainsaw
D Akku-kettensäge
PL Akumulatorowa pilarka łańcuchowa
RUS Аккумуляторная цепная пила
CZ Akumulátorová řetězová pila
H Akkus lánzfűrész
RO Ferăstrăie cu lanț cu acumulator
F Tronçonneuse
I Motosega a batteria
E Inalámbrico motosierra
CN 无绳链锯



40 V	12" 30.5 cm	3/8" 9.32 mm	0.05" 1.3 mm	OIL TANK 0.18 l
2.5 Ah	Li-Ion	AUTOMATIC OIL LUBRICATOR	TOOL-FREE ADJUSTMENT OF CHAIN TENSION	CHARGE LEVEL INDICATOR
		AUTOMATIC CHAIN LUBRICATOR	AUTOMATIC CHAIN BRUSHING	BRUSHLESS MOTOR



COLOR BOX

YATO	V	
YT-85090	40	2

L_{pa} = 86.8 ± 3.0 dB;
L_{ma} = 96.5 ± 3.0 dB;
a_h = 3.5 ± 1.5 m/s²

- GB Battery
D Akkumulator
PL Akumulator
RUS Аккумулятор
CZ Akumulátor
H Akkumulátor
RO Acumulatorul
F Batterie
I Batteria
E Bateria
CN 锂电池



40 V	2.5 Ah	100 Wh
	Li-Ion	



WHITE CARTON BOX & COLOR LABEL

for / dla: YT-85090

YATO	V	
YT-85132	40	10

- GB Battery charger
D Ladegerät
PL Ładowarka
RUS Зарядное устройство
CZ Nabíječka
H Akkutöltő
RO Redresor
F Chargeur de batterie
I Caricabatteria
E Rectificador
CN 充电器



for/dla: 40V	230V~50Hz	for/dla: Li-Ion
	1h	QUICK CHARGING SYSTEM



WHITE CARTON BOX & COLOR LABEL

for / dla: YT-85090, YT-85132

YATO	V	
YT-85133	40	18

- GB Cordless chainsaw
D Akku-kettensäge
PL Akumulatorowa pilarka łańcuchowa
RUS Аккумуляторная цепная пила
CZ Akumulátorová řetězová pila
H Akkus lánzfűrész
RO Ferăstrăie cu lanț cu acumulator
F Tronçonneuse
I Motosega a batteria
E Inalámbrico motosierra
CN 无绳链锯



18 V	3.0 Ah	10" 25 cm	3/8" 9.32 mm	0.05" 1.3 mm
Li-Ion			OIL TANK 0.21 l	



COLOR BOX

YATO	V	
YT-85080	18	2

L_{pa} = 80.8 ± 3.0 dB;
L_{ma} = 93.6 ± 3.68 dB;
a_h = 2.53 ± 1.5 / 3.80 ± 1.5 m/s²

- GB Cordless pole saw
D Akku-Hochentaster
PL Akumulatorowa okrzęsywarka na wysięgniku
RUS Аккумуляторный телескопический вырубитель
CZ Akumulatorová teleskopická vyvívavací pila
H Akkus magassági ágvgágó távsőves
RO Ferăstrăie cu lanț cu telescopic
F Elagueuse sur perche
I Potatore a batteria
E Sierra de pèrtiga telescópica
CN 高枝锯



18 V	3.0 Ah	8" 20 cm
Li-Ion		



COLOR BOX

100-215 cm

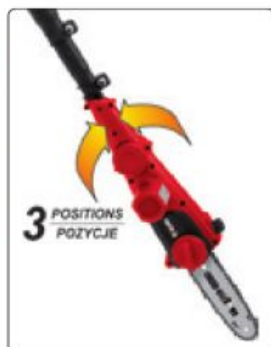

3 POSITIONS POZYCJE

YATO	V	
YT-85120	18	2

L_{pa} = 78.8 ± 3.0 dB;
L_{ma} = 90.7 ± 2.36 dB;
a_h = 2.68 ± 1.5 / 4.84 ± 1.5 m/s²

- GB Cordless telescopic pole saw
D Akku-Teleskop-Hochentaster
PL Akumulatorowe okrzęsywarka na wysięgniku
RUS Аккумуляторный телескопический вырубитель
CZ Akumulátorová teleskopická vyvívavací pila
H Akkus magassági ágvgágó távsőves
RO Ferăstrăie cu lanț cu telescopic cu acumulator
F Elagueuse sur perche telescopique sans-fil
I Decescupigliatore telescopico a batteria
E Sierra de pèrtiga telescópica a bateria
CN 充电式高枝锯



EASY TRANSPORT

L_{pa} = 78.2 ± 3.0 dB;
L_{ma} = 91.2 ± 2.36 dB;
a_h = 2.109 ± 1.5 m/s²



ŁATWY TRANSPORT



18 V	Li-Ion	2.0 Ah	1h
		2500 min	8" 20 cm



COLOR BOX

YATO	V	
YT-82836	18	2

- GB Cordless telescopic pole saw (tool only)
- D Akku-Teleskop-Hochentaster (nur das Gerät)
- PL Akumulatorowa okrzyzywarka na wysięgniku (tylko narzędzie)
- RUS Аккумуляторный телескопический высотерез (только инструмент)
- CZ Akumulátorová teleskopická vyvėtvovací pila (pouze nářadí)
- H Akkus magassági ágvtócsőves (csak a szerszámot)
- RO Ferăstrăie cu lanț cu telescopic cu acumulator (numai sculă)
- F Elagueuse sur perche télescopique sans-fil (outil seulement)
- I Decescopugliatore telescopico a batteria (solo utensile)
- E Sierra de pértiga telescópica a batería (herramienta solamente)
- CN 充电式高枝锯 (光机)

18 V

Li-Ion

2500 mm²

1h*

8"

20 cm

5 m/s



battery not included
akumulatora
nie dołączono

$L_{eq} = 78,2 \pm 3,0$ dB;
 $L_{max} = 91,2 \pm 2,36$ dB;
 $a_s = 2,109 \pm 1,5$ m/s²

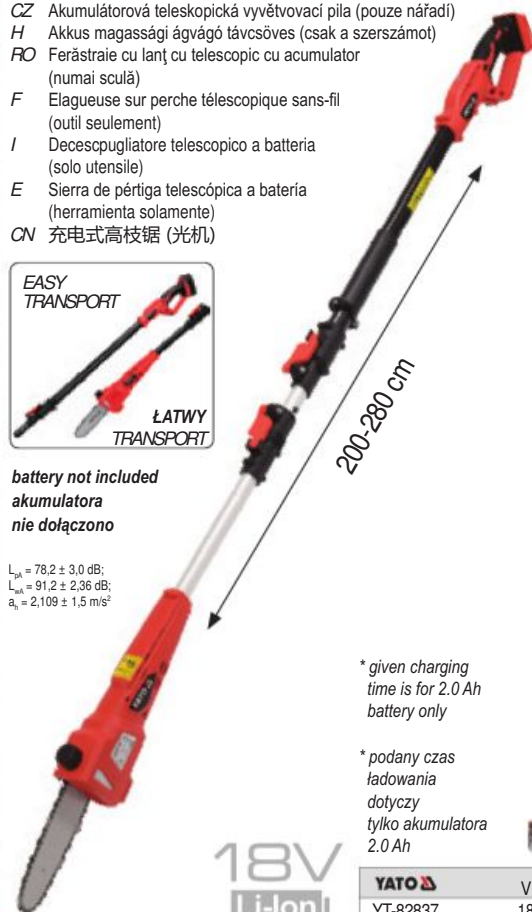

* given charging time is for 2.0 Ah battery only

* podany czas ładowania dotyczy tylko akumulatora 2.0 Ah



18V
Li-Ion

YATO	V	
YT-82837	18	2

- GB Cordless grass trimmer
- D Akku-Rasentrimmer
- PL Akumulatorowa podkaszarka do trawy
- RUS Аккумуляторный телескопический высотерез
- CZ Akumulátorová sekačka na trávu
- H Akkus szegélynyíró
- RO Trimmere de gazon cu acumulator
- F Coupe bordures sans fil
- I Tosaerba a filo a batteria
- E Desmalezadora inalámbrica
- CN 打草机

COLOR BOX



18 V

3.0 Ah

8800 mm²

Li-Ion

250/300 mm



$L_{eq} = 80,8 \pm 3,0$ dB;
 $L_{max} = 88,5 \pm 2,64$ dB;
 $a_s = 4,41 \pm 1,5 / 3,33 \pm 1,5$ m/s²



YATO	V	
YT-85110	18	4

- GB Cordless grass trimmer
- D Akku-Rasentrimmer
- PL Akumulatorowa podkaszarka do trawy
- RUS Аккумуляторный триммер
- CZ Akumulátorová sekačka na trávu
- H Akkus szegélynyíró
- RO Trimmere de gazon cu acumulator
- F Débroussaillse sans-fil
- I Tagliabordi a batteria
- E Desbrozadora a batería
- CN 充电式打草机

18 V

Li-Ion

7200 mm²

2.0 Ah

1h*

250/300 mm



- GB Cordless grass trimmer (tool only)
- D Akku-Rasentrimmer (nur das Gerät)
- PL Akumulatorowa podkaszarka do trawy (tylko narzędzie)
- RUS Аккумуляторный триммер (только инструмент)
- CZ Akumulátorová sekačka na trávu (pouze nářadí)
- H Akkus szegélynyíró (csak a szerszámot)
- RO Trimmere de gazon cu acumulator (numai sculă)
- F Débroussaillse sans-fil (outil seulement)
- I Tagliabordi a batteria (solo utensile)
- E Desbrozadora a batería (herramienta solamente)
- CN 充电式打草机 (光机)

18 V

Li-Ion

7200 mm²

1h*

250/300 mm

battery not included
akumulatora
nie dołączono

* given charging time is for 2.0 Ah battery only

* podany czas ładowania dotyczy tylko akumulatora 2.0 Ah



18V
Li-Ion

YATO	V	
YT-82830	18	2

$L_{eq} = 85,0 \pm 3,0$ dB;
 $L_{max} = 93,0 \pm 3,0$ dB;
 $a_s = 2,5 \pm 1,5$ m/s²

$L_{eq} = 85,0 \pm 3,0$ dB;
 $L_{max} = 93,0 \pm 3,0$ dB;
 $a_s = 2,5 \pm 1,5$ m/s²

18V
Li-Ion

YATO	V	
YT-82831	18	2



GB Cordless hedge trimmer
D Akku-Heckenschere
PL Akumulatorowe nożyce do żywoplotu
RUS Аккумуляторный кусторез
CZ Akumulátorové nůžky na živé ploty
H Akkus sövénynyíró
RO Foarfece de tăiat gard viu cu acumulator

F Taille-haies sans fil
I Tagliasiepi a batteria
E Cortasetos inalámbrico
CN 充电式修枝剪



18 V 3.0 Ah Li-Ion
2400 min⁻¹ 450mm

$L_{pa} = 77.4 \pm 3.0$ dB;
 $L_{ma} = 86.5 \pm 2.07$ dB;
 $a_s = 1.96 \pm 1.5 / 2.07 \pm 1.5$ m/s²



YATO	V	
YT-85100	18	2

GB Cordless hedge trimmer
D Akku-Heckenschere
PL Akumulatorowe nożyce do żywoplotu
RUS Аккумуляторный кусторез
CZ Akumulátorové nůžky na živé ploty
H Akkus sövénynyíró
RO Foarfece de tăiat gard viu cu acumulator
F Taille-haies sans fil

I Tagliasiepi a batteria
E Cortasetos inalámbrico
CN 充电式修枝剪



18 V Li-Ion 2.0 Ah 1h
1050 min⁻¹ 560 mm
22"

$L_{pa} = 80.0 \pm 3.0$ dB;
 $L_{ma} = 87.0 \pm 3.0$ dB;
 $a_s = 3.5 \pm 1.5$ m/s²



YATO	V	
YT-82832	18	2

GB Cordless hedge trimmer (tool only)
D Akku-Heckenschere (nur das Gerät)
PL Akumulatorowe nożyce do żywoplotu (tylko narzędzie)
RUS Аккумуляторный кусторез (только инструмент)
CZ Akumulátorové nůžky na živé ploty (pouze nářadí)
H Akkus sövénynyíró (csak a szerszámot)
RO Foarfece de tăiat gard viu cu acumulator (numai sculă)
F Taille-haies sans-fil (outil seulement)
I Tagliasiepi a batteria (solo utensile)
E Cortasetos inalámbrico (herramienta solamente)
CN 充电式高枝剪 (光机)

battery not included
akumulatora
nie dołączono

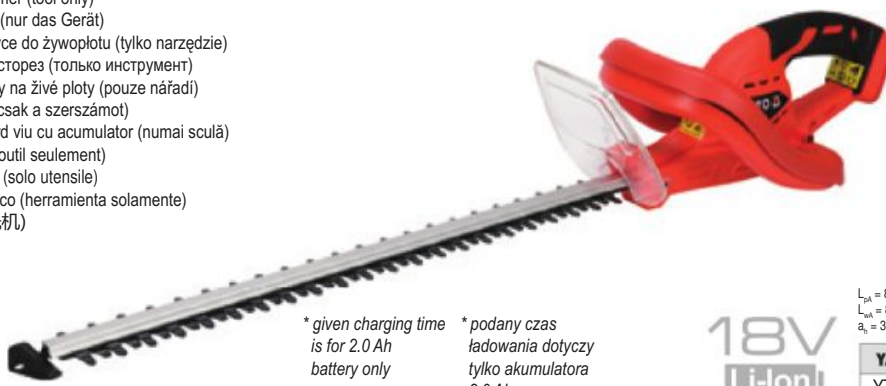

18 V Li-Ion 2.0 Ah 1h*
1050 min⁻¹ 560 mm
22"

$L_{pa} = 80.0 \pm 3.0$ dB;
 $L_{ma} = 87.0 \pm 3.0$ dB;
 $a_s = 3.5 \pm 1.5$ m/s²



YATO	V	
YT-82833	18	2

GB Cordless hedge trimmer
D Akku-Heckenschere
PL Akumulatorowe nożyce do żywoplotu
RUS Аккумуляторный кусторез
CZ Akumulátorové nůžky na živé ploty
H Akkus sövénynyíró
RO Foarfece de tăiat gard viu cu acumulator
F Taille-haies sans-fil
I Tagliasiepi a batteria
E Tijera cortasetos a batería
CN 充电式高枝剪

18 V Li-Ion 2.0 Ah 1h
2100 min⁻¹ 420 mm



$L_{pa} = 77.3 \pm 3.0$ dB;
 $L_{ma} = 88.1 \pm 3.0$ dB;
 $a_s = 1.5 \pm 1.5$ m/s²

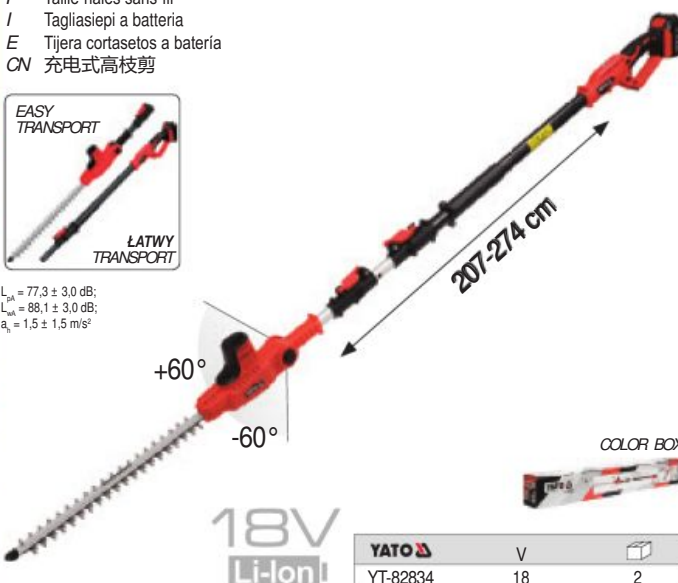

+60°
-60°

COLOR BOX

YATO	V	
YT-82834	18	2

GB Cordless hedge trimmer (tool only)
D Akku-Heckenschere (nur das Gerät)
PL Akumulatorowe nożyce do żywoplotu (tylko narzędzie)
RUS Аккумуляторный кусторез (только инструмент)
CZ Akumulátorové nůžky na živé ploty (pouze nářadí)
H Akkus sövénynyíró (csak a szerszámot)
RO Foarfece de tăiat gard viu cu acumulator (numai sculă)
F Taille-haies sans-fil (outil seulement)
I Tagliasiepi a batteria (solo utensile)
E Tijera cortasetos a batería (herramienta solamente)
CN 充电式高枝剪 (光机)

18 V Li-Ion 2.0 Ah 1h*
2100 min⁻¹ 420 mm

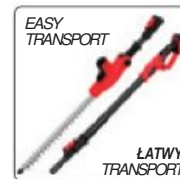

* given charging time is for 2.0 Ah battery only
* podany czas ładowania dotyczy tylko akumulatora 2.0 Ah

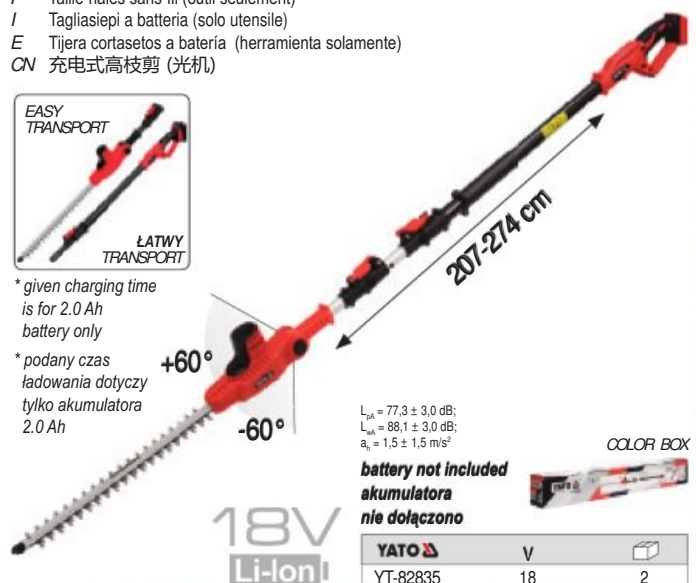

+60°
-60°

COLOR BOX

$L_{pa} = 77.3 \pm 3.0$ dB;
 $L_{ma} = 88.1 \pm 3.0$ dB;
 $a_s = 1.5 \pm 1.5$ m/s²

battery not included
akumulatora
nie dołączono

YATO	V	
YT-82835	18	2

- GB Battery
- D Akkumulator
- PL Akumulator
- RUS Аккумулятор
- CZ Akumulátor
- H Akumulátor
- RO Acumulatorul
- F Batterie
- I Batteria
- E Bateria
- CN 锂电池



18 V 3.0 Ah 54 Wh Li-Ion

WHITE CARTON BOX & COLOR LABEL



for / dla: YT-85080, YT-85100, YT-85110, YT-85120

YATO	V	
YT-85130	18	18

- GB Battery charger
- D Ladegerät
- PL Ładowarka
- RUS Зарядное устройство
- CZ Nabíječka
- H Akkutöltő
- RO Redresor
- F Chargeur de batterie
- I Caricabatteria
- E Rectificador
- CN 充电器



for/dla: 18V 230V~50Hz Li-Ion

WHITE CARTON BOX & COLOR LABEL



for / dla: YT-85080, YT-85100, YT-85110, YT-85120, YT-85130

YATO	V	
YT-85131	18	27

- GB Battery
- D Akkumulator
- PL Akumulator
- RUS Аккумулятор
- CZ Akumulátor
- H Akumulátor
- RO Acumulatorul
- F Batterie
- I Batteria
- E Bateria
- CN 锂电池



18 V Li-Ion for/dla: Li-Ion

COLOR BOX



for / dla: YT-82830, YT-82831, YT-82832, YT-82833, YT-82834, YT-82835, YT-82836, YT-82837

YATO	V	capacity / pojemność (Ah)	charging time / czas ładowania (h)	
YT-82842	18	2.0	1.0	20
YT-82843	18	3.0	1.5	20
YT-82844	18	4.0	2.0	20

- GB Battery charger
- D Ladegerät
- PL Ładowarka
- RUS Зарядное устройство
- CZ Nabíječka
- H Akkutöltő
- RO Redresor
- F Chargeur de batterie
- I Caricabatteria
- E Rectificador
- CN 充电器



for/dla: 18V 220-240V~50/60Hz 1h CHARGING LADOWANIE 1.5h CHARGING LADOWANIE 2h CHARGING LADOWANIE 2.0 Ah 3.0 Ah 4.0 Ah

COLOR BOX



for / dla: YT-82830, YT-82831, YT-82832, YT-82833, YT-82834, YT-82835, YT-82836, YT-82837

YATO	V	
YT-82848	18	10

- GB Electric lawn mower
- D Elektrischer grasmäher
- PL Kosiarka elektryczna
- RUS Электрокосилка
- CZ Elektrická sekačka
- H Elektromos fűnyíró-gép
- RO Cositoare electrica pt. iarba
- F Tondeuse à gazon électrique
- I Tosaerba elettrici
- E Contracesped
- CN 电动草坪机

230V~50-60Hz 1300 W 3400 mm³ 30 l 330mm 60mm 40mm 20mm 140mm

L_{WA} = 82,3 ± 3,0 dB;
L_{WA} = 93,1 ± 1,91 dB;
a₁ = 2,72 ± 1,5 m/s²



COLOR BOX



YATO	W	
YT-85200	1300	1

- GB Electric lawn mower
- D Elektrischer grasmäher
- PL Kosiarka elektryczna
- RUS Электрокосилка
- CZ Elektrická sekačka
- H Elektromos fűnyíró-gép
- RO Cositoare electrica pt. iarba
- F Tondeuse à gazon électrique
- I Tosaerba elettrici
- E Contracesped
- CN 电动草坪机

230V~50-60Hz 1800 W 3300 mm³ 50 L 330mm 70, 60, 50, 40, 30, 20 mm 160 200 mm

L_{WA} = 82,8 ± 3,0 dB;
L_{WA} = 93,7 ± 2,4 dB;
a₁ = 3,15 ± 1,5 m/s²



COLOR BOX



YATO	W	
YT-85205	1800	1

- GB Electric lawn mower
D Elektrischer grasmäher
PL Kosiarka elektryczna
RUS Электрокосилка
CZ Elektrická sekačka
H Elektromos fűnyíró-gép
RO Cositoare electrica pt. iarba
F Tondeuse à gazon électrique
I Tosaerba elettrici
E Contracesped
CN 电动草坪机

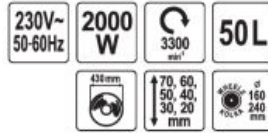

$L_{pA} = 83,6 \pm 3,0$ dB;
 $L_{pM} = 94,6 \pm 1,80$ dB;
 $a_s = 3,45 \pm 1,5$ m/s²



COLOR BOX

YATO	W	
YT-85208	2000	1

- GB Gasoline chainsaw
D Motorsägen
PL Piłarka spalinowa
RUS Бензопила
CZ Motorová pila
H Benzinláncfűrész
- RO Drujba pe benzina
F Tronçonneuses
I Motosega a benzina
E Motosierra de gasolina
CN 油锯

$L_{pA} = 93,35 \pm 1,08$ dB;
 $L_{pM} = 112,33 \pm 1,08$ dB;
 $a_s = 5,600 \pm 1,5 / 4,884 \pm 1,5$ m/s²



COLOR BOX

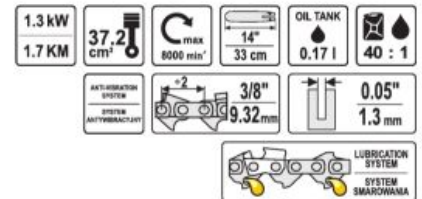

YATO	kW	KM	L (mm)	
YT-84895	1.3	1.7	330	1

- GB Gasoline chainsaw
D Motorsägen
PL Piłarka spalinowa
RUS Бензопила
CZ Motorová pila
H Benzinláncfűrész
- RO Drujba pe benzina
F Tronçonneuses
I Motosega a benzina
E Motosierra de gasolina
CN 油锯

$L_{pA} = 89,69 \pm 1,37$ dB;
 $L_{pM} = 109,19 \pm 1,37$ dB;
 $a_s = 5,650 \pm 1,5 / 6,027 \pm 1,5$ m/s²



COLOR BOX

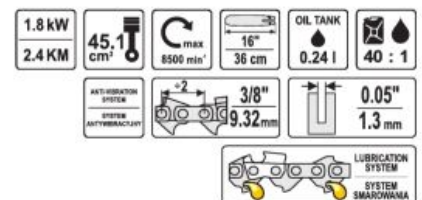

YATO	kW	KM	L (mm)	
YT-84901	1.8	2.4	360	1

- GB Gasoline backpack sprayer
D Benzin Motorsprüher
PL Opryskiwacz plecakowy spalinowy
RUS Бензиновый ранец-опрыскиватель
CZ Motorový rosič
- H Benzines permetező
RO Pulverizatoare pe benzina
F Pulvérisateur a essence
I Atomizzatore
E Pulverizador de gasolina
CN 喷雾喷粉机

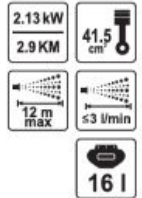

WHITE
CARTON BOX
& COLOR
LABEL



$L_{pA} = 78,8 \pm 3,0 / 97,8 \pm 3,0$ dB;
 $L_{pM} = 89,8 \pm 3,0 / 108,8 \pm 3,0$ dB;
 $a_s = 1,94 \pm 1,5 / 8,93 \pm 1,5$ m/s²

YATO	kW	KM	
YT-85140	2.13	2.9	1

- GB Gasoline chainsaw
D Motorsägen
PL Piarka spalinowa
RUS Бензопила
CZ Motorová pila
H Benzin láncfűrész
- RO Drujba pe benzina
F Tronçonneuses
I Motosega a benzina
E Motosierra de gasolina
CN 油锯

2.5 kW	56.5 cm ³	8500 min ⁻¹	20" / 48 cm	OIL TANK 0.24 l	40 : 1
3.4 KM	ANT-VIBRATION SYSTEM	0.325" / 8.25 mm	0.058" / 1.5 mm	LUBRICATION SYSTEM	



L_{PA} = 94,59 ± 1,34 dB;
L_{WA} = 113,46 ± 1,34 dB;
a_v = 7,234 ± 1,5 / 9,528 ± 1,5 m/s²

COLOR BOX

YATO	kW	KM	L (mm)	Box
YT-84910	2.5	3.4	480	1

- GB Brushcutter
D Motorsensen
PL Kosa spalinowa
RUS Бензокоса
CZ Motorový křovinořez
H Motoros kasza
RO Motocoasa
- I Falce fienăia a benzina
E Motoguadaña de gasolina
CN 割草机

0.8 kW	1.1 KM	29.3 cm ³	255 mm	430 mm	40 : 1	0.48 L	EASY START
LATWY TRANSPORT							



L_{PA} = 92,63 ± 2,5 dB;
L_{WA} = 109,41 ± 2,5 dB;
a_v = 4,617 ± 1,5 / 4,007 ± 1,5 m/s²

COLOR BOX

YATO	kW	KM	Box
YT-85001	0.8	1.1	1

- GB Brushcutter
D Motorsensen
PL Kosa spalinowa
RUS Бензокоса
CZ Motorový křovinořez
H Motoros kasza
RO Motocoasa
- I Falce fienăia a benzina
E Motoguadaña de gasolina
CN 割草机

1.25 kW	1.7 KM	42.7 cm ³	255 mm	430 mm	40 : 1	0.85 L	EASY START
LATWY TRANSPORT							



L_{PA} = 96,3 ± 3,0 dB;
L_{WA} = 110,3 ± 3,0 dB;
a_v = 3,992 ± 1,5 / 10,403 ± 1,5 m/s²

COLOR BOX

YATO	kW	KM	Box
YT-85003	1.25	1.7	1

- GB Brushcutter
D Motorsensen
PL Kosa spalinowa
RUS Бензокоса
CZ Motorový křovinořez
H Motoros kasza
RO Motocoasa
I Falce fienăia a benzina
E Motoguadaña de gasolina
CN 割草机

1.25 kW	1.7 KM	42.7 cm ³	255 mm	430 mm	40 : 1	1 L
---------	--------	----------------------	--------	--------	--------	-----



L_{PA} = 88,59 ± 5,29 dB;
L_{WA} = 106,65 ± 5,29 dB;
a_v = 12,479 ± 1,5 / 4,692 ± 1,5 m/s²

COLOR BOX

YATO	kW	KM	Box
YT-85000	1.25	1.7	1

- GB Petrol hedge trimmer
D Benzin-Heckenscheren
PL Spalinowe nożyce do żywoplotu
RUS Бензоножицы
CZ Plotostřih na živé ploty
H Benzines sövényvágó
RO Tuns gard viu
F Taille-haie
I Tosasiepi per privati
E Corta sebes a gasolina
CN 绿篱剪

0.7 kW	0.99 KM	25.4 cm ³	7000 min ⁻¹	550 mm	1850 min ⁻¹	40 : 1	0.6 L
--------	---------	----------------------	------------------------	--------	------------------------	--------	-------



L_{PA} = 96 ± 3 dB;
L_{WA} = 105,3 ± 0,48 dB;
a_v = 6,9 ± 1,5 m/s²

COLOR BOX

YATO	kW	KM	L (mm)	Box
YT-85021	0.7	0.99	550	1

GB Chainsaw guide bar
D Kettensägeführung
PL Prowadnica
do pił łańcuchowych

RUS Шина для бензопил
CZ Vodičí lišta k řetězové pile
H Lánčvezető

RO Lama de ghidai pt. ferastrau
F Guide de tronçonneuse
I Barra per motosega

E Barra guía motosierra
CN 导轨

COLOR
PAPER
POUCH

Mn
65

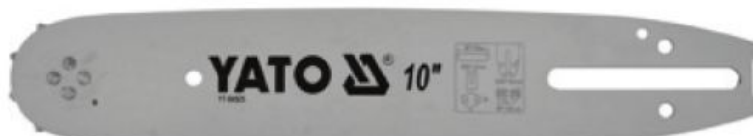

for / dla: YT-84948, YT-84960

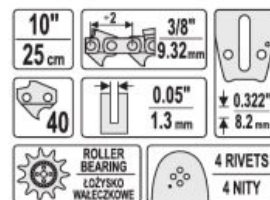

YATO	size / rozmiar	
YT-84925	10" (25 cm)	20



for / dla: YT-84949, YT-84960

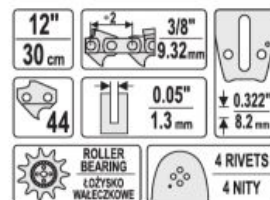

YATO	size / rozmiar	
YT-84927	12" (30 cm)	20



for / dla: YT-8499395, YT-84963



YATO	size / rozmiar	
YT-84928	12" (30 cm)	20



for / dla: YT-84950, YT-84960

competitors / odpowiedniki: Oregon: 140SPEA074; Alpina: 4112560; Stihl: 3005 000 809; Windsor: 14ST50SSR

for / dla: Alpina: 270, 280, Elletra 160, Elletra 170, Energy 1.6, Energy 1.8, P360, P361, P370, P390, P391, Sinergy 35, Sinergy 40; Oleo-Mac: 240, OEM200; Stihl: 009, 010, 011, 012, 017, 018, 019, 019T, 020, 020T, 021, 021C, 023, 025, 25, MS160, MS170, MS180, MS181, MS191, MS192, MS200, MS200T, MS210, MS211, MS230, MS231, MS241, MS250, MS251, MSE140, MSE200

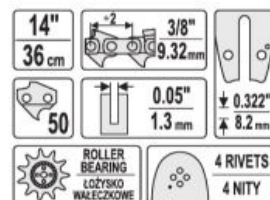

YATO	size / rozmiar	
YT-84930	14" (36 cm)	20



for / dla: YT-84951, YT-84960

competitors / odpowiedniki: Oregon: 140SDEA041; Oleo-mac: 50030218; Husqvarna: 501854149; Windsor: 14PKU50SSR; Makita: 442035661, 472035661, 482035661; Alpina: 4112300; Dolmar: 412035661, 452035661, 462035661; Partner: 530044328

for / dla: Al-Ko: 2000, 2300, 25A, E1200, E125, E1400, E1500, KE3500, VARIO, KE4000, KS, KSB; Alpina: 352, 382, A10E, A14E, E120, E130, E150, ELECTRIC, ES182, ES202, KS1400B, KS1500B; Bosch: 1586, 40-19PRO, AKE30B, AKE30LI, AKE35-19PRO, AKE35B, AKE40B, BULLCRAFT, GKE35BC, GKE40BC, PKE25, PKE30B, PKE35B, PKE40; Dolmar: 100, 101, 102, 103, 104, 105, 106, 108, 275, 285, ES140, ES151, ES152, ES152A, ES153, ES160, ES161, ES162, ES162A, ES163, ES172, ES172A, ES173, ES183, ES2035, ES2040, ES3, ES30, ES37, ES40, ES41, ES6, PS33, PS330, PS3300TH, PS34, PS340, PS341, PS3410, PS344, PS350, PS390, PS400, PS401, PS41, PS45; Echo: CS2600ES, CS260TES, CS2700ES, CS310WES, CS3500ES, CS350WES, CS351WES; Einhell: BG-EC-1840TC, BG-PC-4040, EKS1650, KSE, KSE1435, KSE1635, KSE1640, KSE2000, PES1540, PES1640, PES30, PES34, PES35, PES40, PKS1635, PKS1840, PROFIL; Hitachi: CS280A, CS280B, CS30EH, CS350A, CS350B, CS35B; Homelite: 20AV, 23AV, 27, 3300, 3335, 350, 3550, 3800, 3850, 4500, 4550, S40, HCS3335, HCS4041CA, PS33, RANGER, TIMBERMAN, UT10901, UT10926, UT10974; Husqvarna: 23, E16, E316, E317, E321, T425; Jonsered: 2033TH; Makita: 5012, 5014, 5016, BUC122RFE, BUC250RDE, DCS232T, DCS300, DCS330S, DCS340, DCS341, DCS3410TH, DCS350, DCS3501, DCS380, DCS390, DCS400, DCS401, DCS4610, EA3201, EA3500F35B, EA3500F40B, UC250DWB, UC3000, UC3030A, UC3500, UC3501, UC3520A, UC3530AK, UC4000, UC4020A, UC4030AK, UC4530A; McCulloch: 10-42, 10-49, 335, 435, 440, 441, 442, 4600, 4700, 4900, 5000, 738, TIMBERBEAR-849, TITAN41, TITAN46; Oleo-Mac: 931, 932, GS35, GS350, GS370, GS410C; Partner: 330, 335, 340, 345, 350, 351, 352, 360, 370, 385, 391, 395, P390, P420, P842; Ryobi: APR02, PCN3335; Skil: 1620U, 1634U, 1636U

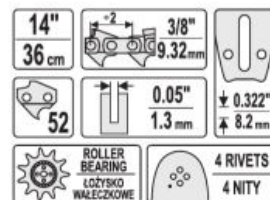

YATO	size / rozmiar	
YT-84931	14" (36 cm)	20



for / dla: YT-84940, YT-84963

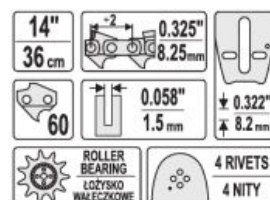

YATO	size / rozmiar	
YT-849311	14" (36 cm)	20

GB Chainsaw guide bar
D Kettensägeführung
PL Prowadnica
do pil łańcuchowych

RUS Шина для бензопил
CZ Vodící lišta k řetězové pile
H Láncevezető

RO Lama de ghidai pt. ferastrau
F Guide de tronçonneuse
I Barra per motosega

E Barra guía motosierra
CN 导板

COLOR
PAPER
POUCH

Mn
65



for / dla: YT-84961

competitors / odpowiedniki: Oregon: 158SLHD009; Husqvarna: 508914356; Windsor: 15HS58SPNA

for / dla: Alpina: P660, P690, P700, P750, P800, PROF700, PROF800; Dolmar: PS6400, PS6400H, PS7300, PS7300H, PS7900, PS7900H, PS9000, PS9010; Dolpima: PS190, PS290, PS390, PS490; Echo: CS3500, CS350WES, CS351WE; Husqvarna: 1100, 160, 162, 181, 2100XP, 2101, 2101XP, 260, 266, 268, 272, 281XP, 285, 288XP, 298, 298X, 298XG, 3120, 3120XP, 365, 371, 371XP, 371XPG, 372, 372XP, 372XPG, 380, 385, 385XP, 394, 394XP, 394XPG, 395, 395XP, 395XPG, 480, 562XP, 570, 575, 575XP, 576XP, 61, 64, 65, 66, 70, 77; Jonsered: 1020, 2065, 2071, 2077, 2083, 2094, 2095, 2165, 2171, 2186, 625, 630, 630 SUPER, 670, 670 CHAMP, 820; Makita: DCS6400, DCS6401, DCS7300, DCS7301, DCS7900, DCS79001, DCS9000, DCS9010; Partner: 660, 710, P7700; Solo: 603, 662, 665, 667, 670, 675, 680, 681, 690, 694

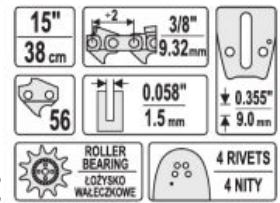

YATO	size / rozmiar	
YT-84932	15" (38 cm)	20



for / dla: YT-84952, YT-84960

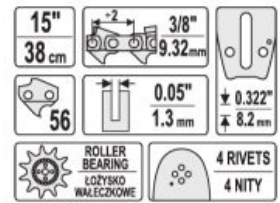

YATO	size / rozmiar	
YT-849321	15" (38 cm)	20



for / dla: YT-84905, YT-84945, YT-84962

competitors / odpowiedniki: Oregon: 50MLBK095; Dolmar: 415038141; Husqvarna: 508926164, 508926364; Makita: 445038141; Windsor: 15CJL50SPYJ

for / dla: Dolmar: 109, 110, 111, 112, 113, 114, 115i, 116, PS460, PS4600, PS4605, S500, PS5000, PS510, PS5100S, PS540; Husqvarna: 133, 136, 137, 141, 142, 154, 234, 238, 240, 242, 242XP, 246, 254, 257, 261, 262, 339XP, 340, 345, 346, 346XP, 350, 351, 353, 357, 357XP, 359, 36, 40, 41, 42, 435, 435E, 44, 440E, 444, 445, 445E, 45, 450E, 455 RANCHER, 455E RANCHER, 460, 460 RANCHER, 50, 51, 550, 560XP, T435; Jonsered: 2012, 2014, 2015, 2016, 2036, 2040, 2041, 2045, 2050, 2051, 2054, 2055, 2063, 2141, 2145, 2147, 2149, 2150, 2152, 2153, 2155, 2156, 2159, 2163, 370, 380, 410, 420, 425, 435, 45, 450, 451, 451EVS, 452, 455, 490, 49SP, 50, 51, 510, 52, 520, 521, 525, 535, 590, CS2149W, CS2152W; Makita: 45, DCS430, DCS43001, DCS4300I, DCS431, DCS460, DCS4600S, DCS500, DCS5000, DCS5030, DCS520, DCS5200I; Oleo-Mac: 850, 938, 940, 941, 942, 942C, 945, 946, 947, 950, 950 Super, 950A, 951, 952, 956, 962, E300F, GS410CX, GS44; Partner: 1200EL, 1400EL, 1450EL, 1500EL, 1650EL, 365, 400, 405, 410, 450, 460, 465, 470, 495, 500, 510, 540, 545, P500, P5000, P5500; Solo: 639, 641, 644, 645, 647, 650, 651, 652, 656, 665

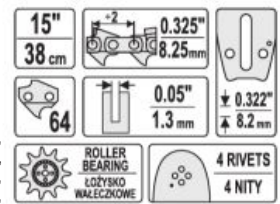

YATO	size / rozmiar	
YT-84933	15" (38 cm)	20



for / dla: YT-84900, YT-84941, YT-84963

competitors / odpowiedniki: Oregon: 158PXBK095; Dolmar: 415038631; Husqvarna: 508912164, 508912364; Makita: 445038631; Solo: 6900343, 6900343K, 6900343N

for / dla: Dolmar: 109, 110, 111, 112, 113, 114, 115i, 116, ES1800, PS460, PS4600, PS4605, PS500, PS5000, PS510, PS5100S, PS540; Homelite: 250, 252, 290, 290C, 300, 340, 340C, 3850B, 3850C, 4045, 415B, 444, 4550B, HCS4040, HCS4446CA; Husqvarna: 133, 136, 137, 141, 142, 154, 234, 235, 238, 240, 242, 242XP, 246, 254, 257, 261, 262, 339XP, 340, 345, 346, 346XP, 350, 351, 353, 357, 357XP, 359, 36, 40, 41, 42, 435, 435E, 44, 440, 440E, 444, 445, 445E, 45, 450E, 455 RANCHER, 455E RANCHER, 460, 460 RANCHER, 50, 51, 550, 560XP, T435; Jonsered: 2012, 2014, 2015, 2016, 2036, 2040, 2041, 2045, 2050, 2051, 2054, 2055, 2063, 2141, 2145, 2147, 2149, 2150, 2152, 2153, 2155, 2159, 2163, 370, 380, 410, 420, 425, 435, 45, 450, 451, 451EVS, 452, 455, 490, 49SP, 50, 51, 510, 52, 520, 521, 525, 535, 590, CS2149W, CS2152W; Makita: 45, DCS430, DCS43001, DCS4300I, DCS431, DCS460, DCS4600S, DCS500, DCS5000, DCS5030, DCS520, DCS5200I; NAC: NO-CS38, SPS01-45, SPS01-52, SPS02-45, YD 40/45, YD40, YD52; Oleo-Mac: 850, 938, 940, 941, 942, 942C, 945, 946, 947, 950, 950 Super, 950A, 951, 952, 956, 962, E300F; Partner: 365, 400, 405, 410, 450, 460, 465, 470, 495, 500, 510, 540, 545, P500, P5000, P5500

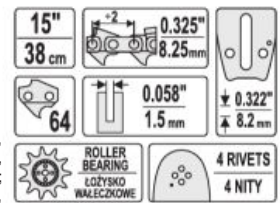

YATO	size / rozmiar	
YT-84934	15" (38 cm)	20



for / dla: YT-84953, YT-84960

competitors / odpowiedniki: Oregon: 160SDEA041; Oleo-Mac: 50050092; Husqvarna: 530044508; Windsor: 16PKU50SSR; Makita: 442040661, 442040661; Alpina: 4112500; Partner: 530044329

for / dla: Al-Ko: 2000, 2300, 25A, E1200, E125, E1400, E1500, KE3500 VARIO, KE4000, KS, KSB; Alpina: 352, 382, A10E, A14E, E120, E130, E150, ELECTRIC ES182, ES202, KS1400B, KS1500B; Dolmar: 100, 101, 102, 103, 104, 105, 106, 108, 275, 285, ES140, ES151, ES152, ES152A, ES153, ES160, ES161, ES162, ES162A, ES163, ES172, ES172A, ES173, ES183, ES2035, ES2040, ES3, ES30, ES37, ES40, ES41, ES6, PS33, PS330, PS3300TH, PS34, PS340, PS341, PS3410, PS344, PS350, PS390, PS400, PS401, PS41, PS45; Echo: CS2600ES, CS2600TES, CS2700ES, CS310WES, CS3500ES, CS350WES, CS351WES, CS360WES; Hitachi: CS280A, CS280B, CS350A, CS350B, CS35B; Homelite: 20AV, 23AV, 27, 3300, 3335, 3350, 3550, 3800, 3850, 4500, 4550, CS40, HCS3335, HCS4041CA, PS33, RANGER, TIMBERMAN, UT10901, UT10926, UT10974; Husqvarna: 23, E16, E316, E317, E321, T425; Jonsered: 2033TH; Makita: 5012, 5014, 5016, BUC122RFE, BUC250RDE, DCS230T, DCS232T, DCS300, DCS300S, DCS330, DCS330S, DCS34, DCS340, DCS341, DCS3410TH, DCS350, DCS3500, DCS3501, DCS3520A, DCS380, DCS390, DCS400, DCS401, DCS4610, UC3000, UC3030A, UC3500, UC3501, UC3520A, UC3530AK, UC4000, UC4030AK; McCulloch: 338, 442; Oleo-Mac: 931, 932, GS35, GS350, GS370, GS410C; Partner: 330, 335, 340, 345, 350, 351, 352, 360, 370, 385, 391, 395, P390, P420, P842; Ryobi: APR02, PCN3335

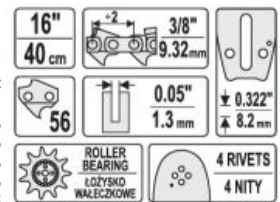

YATO	size / rozmiar	
YT-84935	16" (40 cm)	20



for / dla: YT-84942, YT-84963

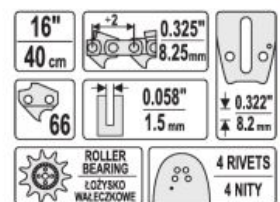

YATO	size / rozmiar	
YT-84931	16" (40 cm)	20

GB Chainsaw guide bar
D Kettensägeführung
PL Prowadnica do pił łańcuchowych

RUS Шина для бензопил
CZ Vodicí lišta k řetězové pile
H Lánčvezető

RO Lama de ghidai pt. ferastrau
F Guide de tronçonneuse
I Barra per motosega

E Barra guía motosierra
CN 导轨

COLOR PAPER POUCH



for / dla: YT-84956, YT-84960

18" 45 cm		3/8" 9.32 mm		Mn 65
	62	0.05" 1.3 mm	± 0.322" ± 8.2 mm	4 RIVETS 4 NITY
	ROLLER BEARING ŁOŻYSKO WALECZKOWE		4 RIVETS 4 NITY	
YATO size / rozmiar		YT-849355 18" (45 cm) 20		



for / dla: YT-84900, YT-84943, YT-84963

competitors / odpowiedniki: Oregon: 188SLGK095; Dolmar: 415045631; Makita: 415045631; Windsor: 18CJL58SPYJ9

for / dla: Dolmar: 109, 110, 111, 112, 113, 114, 115, 116, ES1800, PS460, PS460S, PS500, PS5000, PS510, PS5100S, PS540; Homelite: 250, 252, 290, 290C, 300, 340, 340C, 3850B, 3850C, 4045, 415B, 444, 4550B, HCS4040, HCS4446CA; Husqvarna: 133, 136, 137, 141, 142, 154, 234, 238, 240, 242, 242XP, 246, 254, 257, 261, 262, 339XP, 340, 345, 346, 346XP, 350, 351, 353, 357, 357XP, 359, 36, 40, 41, 42, 435, 435E, 44, 440, 440E, 444, 445, 445E, 45, 450E, 455 RANCHER, 455E RANCHER, 460, 460 RANCHER, 50, 51, 550, 560XP, T435; Jonsered: 2012, 2014, 2015, 2016, 2036, 2040, 2041, 2045, 2050, 2051, 2054, 2055, 2063, 2141, 2145, 2147, 2149, 2150, 2152, 2153, 2155, 2156, 2159, 2163, 370, 380, 410, 420, 425, 435, 45, 450, 451, 451EVS, 452, 455, 490, 49S, P50, 51, 510, 52, 520, 521, 525, 535, 590, CS2149W, CS2152W; Makita: 45, DCS430, DCS43001, DCS4300I, DCS431, DCS460, DCS4600S, DCS500, DCS5000, DCS5030, DCS520, DCS5200I; NAC: NO-CS38, SPS01-45, SPS01-52, SPS02-45, YD 40/45, YD40, YD52; Oleo-Mac: 850, 938, 940, 941, 942, 942C, 945, 946, 947, 950, 950 Super, 950A, 951, 952, 956, 962, E300F; Partner: 365, 400, 405, 410, 450, 460, 465, 470, 495, 500, 510, 540, 545, P500, P5000, P5500; Solo: 639, 641, 644, 645, 647, 650, 651, 652, 656, 665

18" 45 cm		0.325" 8.25 mm		Mn 65
	72	0.058" 1.5 mm	± 0.322" ± 8.2 mm	4 RIVETS 4 NITY
	ROLLER BEARING ŁOŻYSKO WALECZKOWE		4 RIVETS 4 NITY	
YATO size / rozmiar		YT-84936 18" (45 cm) 20		



for / dla: YT-84944, YT-84963

20" 50 cm		0.325" 8.25 mm		Mn 65
	76	0.058" 1.5 mm	± 0.322" ± 8.2 mm	4 RIVETS 4 NITY
	ROLLER BEARING ŁOŻYSKO WALECZKOWE		4 RIVETS 4 NITY	
YATO size / rozmiar		YT-84937 20" (50 cm) 20		

GB Chain for chainsaw
D Kette für Kettensägen
PL Łańcuch tnący do pił
RUS Цепь для бензопил

CZ Řetěz pro řetězové pily
H Lánč lánčfűrész
RO Lant pt. druþba
F Chaîne de tronçonneuse

I Taglio per motoseghea
E Cadena de motosierra
CN 蠟沫

COLOR BOX WITH EURO HOLE



for / dla: YT-84928

12" 30 cm		0.325" 8.25 mm		Mn 65
	50	0.058" 1.5 mm	± 0.322" ± 8.2 mm	SEMI-CHESEL POL-OLITO
	LUBRICATION SYSTEM SYSTEM SMAROWANIA		4 RIVETS 4 NITY	
YATO size / rozmiar		YT-849395 12" (30 cm) 50		



for / dla: YT-84900

for / dla: Alpina: A40, A40E, P400, P450, P460, P500, P510, P522, PRO540, PRO600, PROF-41, PROF-45; Dolmar: 109, 110, 111, 112, 113, 114, 115, 116, ES1800, PS460, PS4600, PS460S, PS500, PS5000, PS510, PS5100S, PS540; Echo: CS4200ES, CS4400; Homelite: 250, 252, 290, 290C, 300, 340, 340C, 3850B, 3850C, 415B, 444, 4550B, HCS4040, HCS4045, HCS4446CA; Husqvarna: 133, 136, 137, 140, 141, 142, 154, 234, 235, 238, 240, 240e, 242, 242XP, 246, 254, 254XP, 257, 261, 262, 338XP, 339XP, 340, 345, 346, 346XP, 350, 351, 353, 357, 357XP, 359, 36, 365, 40, 41, 42, 435, 435E, 44, 440E, 444, 445, 445E, 45, 450E, 455 RANCHER, 455E ANCHER, 460, 460 RANCHER, 50, 51, 55; Jonsered: 2012, 2014, 2015, 2016, 2036, 2040, 2041, 2045, 2050, 2051, 2054, 2055, 2063, 2141, 2145, 2147, 2149, 2150, 2152, 2153, 2155, 2156, 2159, 2163, 370, 380, 410, 420, 425, 435, 45, 450, 451, 451EVS, 452, 455, 490, 49SP, 50, 51, 510, 52, 521, 525, 535, 590, CS2149W, CS2152W; Makita: 45, DCS430, DCS43001, DCS4300I, DCS431, DCS460, DCS4600S, DCS4630, DCS500, DCS5000, DCS5030, DCS520, DCS5200I; NAC: NO-CS38, SPS01-45, SPS01-52, SPS02-45, YD 40/45, YD40, YD52; Oleo-Mac: 850, 938, 940, 941, 942, 945, 946, 947, 950, 950 Super, 950A, 951, 952, 956, 962, E300F; Partner: 1650, 365, 400, 405, 410, 450, 460, 465, 470, 495, 500, 510, 540, 545, P500, P5000, P5500

14" 36 cm		0.325" 8.25 mm		Mn 65
	56	0.058" 1.5 mm	± 0.322" ± 8.2 mm	SEMI-CHESEL POL-OLITO
	LUBRICATION SYSTEM SYSTEM SMAROWANIA		4 RIVETS 4 NITY	
YATO size / rozmiar		YT-84940 14" (36 cm) 50		



for / dla: YT-84900, YT-84934

for / dla: Dolmar: 109, 110, 111, 112, 113, 114, 115, 116, ES1800, PS460, PS4600, PS460S, PS500, PS5000, PS5510, PS5100S, PS540; Husqvarna: 154, 257, 440e, 133, 136, 137, 140, 141, 142, 234, 235, 238, 240, 240e, 242, 242XP, 246, 254, 254XP, 261, 262, 338XP, 339XP, 340, 345, 346, 346XP, 350, 351, 353, 357, 357XP, 359, 36, 365, 372XP, 40, 41, 42, 435, 435E, 44, 444, 445, 445E, 45, 450E, 455 RANCHER, 455E RANCHER, 460 RANCHER, 50, 51, 55, T435; Jonsered: 520, 2012, 2014, 2015, 2016, 2036, 2040, 2041, 2045, 2050, 2051, 2054, 2055, 063, 2141, 2145, 2147, 2149, 2150, 2152, 2153, 2155, 2156, 2159, 2163, 370, 380, 410, 420, 425, 435, 45, 450, 451, 451EVS, 452, 455, 490, 49SP, 50, 51, 510, 52, 521, 525, 535, 590, CS2149W, CS2152W; Makita: 45, DCS430, DCS43001, DCS4300I, DCS431, DCS460, DCS4600S, DCS4630, DCS500, DCS5000, DCS5030, DCS520, DCS5200I; NAC: NO-CS38, SPS01-45, SPS01-52, SPS02-45, YD 40/45, YD40, YD52; Oleo-Mac: 850, 938, 940, 941, 942, 945, 946, 947, 950, 950 Super, 950A, 951, 952, 956, 962, E300F; Partner: 1650, 365, 400, 405, 410, 450, 460, 465, 470, 495, 500, 510, 540, 545, P500, P5000, P5500

15" 38 cm		0.325" 8.25 mm		Mn 65
	64	0.058" 1.5 mm	± 0.322" ± 8.2 mm	SEMI-CHESEL POL-OLITO
	LUBRICATION SYSTEM SYSTEM SMAROWANIA		4 RIVETS 4 NITY	
YATO size / rozmiar		YT-84941 15" (38 cm) 50		



for / dla: YT-84900

for / dla: Dolmar: 109, 110, 111, 112, 113, 114, 115, 116, ES1800, PS460, PS4600, PS460S, PS500, PS5000, PS5510, PS5100S, PS540; Husqvarna: 154, 257, 440e, 133, 136, 137, 140, 141, 142, 234, 235, 238, 240, 240e, 242, 242XP, 246, 254, 254XP, 261, 262, 338XP, 339XP, 340, 345, 346, 346XP, 350, 351, 353, 357, 357XP, 359, 36, 365, 372XP, 40, 41, 42, 435, 435E, 44, 444, 445, 445E, 45, 450E, 455 RANCHER, 455E RANCHER, 460 RANCHER, 50, 51, 55, T435; Jonsered: 520, 2012, 2014, 2015, 2016, 2036, 2040, 2041, 2045, 2050, 2051, 2054, 2055, 063, 2141, 2145, 2147, 2149, 2150, 2152, 2153, 2155, 2156, 2159, 2163, 370, 380, 410, 420, 425, 435, 45, 450, 451, 451EVS, 452, 455, 490, 49SP, 50, 51, 510, 52, 521, 525, 535, 590, CS2149W, CS2152W; Makita: 45, DCS430, DCS43001, DCS4300I, DCS431, DCS460, DCS4600S, DCS4630, DCS500, DCS5000, DCS5030, DCS520, DCS5200I; NAC: NO-CS38, SPS01-45, SPS01-52, SPS02-45, YD 40/45, YD40, YD52; Oleo-Mac: 850, 938, 940, 941, 942, 945, 946, 947, 950, 950 Super, 950A, 951, 952, 956, 962, E300F; Partner: 1650, 365, 400, 405, 410, 450, 460, 465, 470, 495, 500, 510, 540, 545, P500, P5000, P5500

16" 40 cm		0.325" 8.25 mm		Mn 65
	66	0.058" 1.5 mm	± 0.322" ± 8.2 mm	SEMI-CHESEL POL-OLITO
	LUBRICATION SYSTEM SYSTEM SMAROWANIA		4 RIVETS 4 NITY	
YATO size / rozmiar		YT-84942 16" (40 cm) 50		

GB Chain for chainsaw
D Kette für Kettensägen
PL Łańcuch łańcuch do pił
RUS Цепь для бензопилы

CZ Řetěz pro řetězové pily
H Lånc låncfűrész
RO Lant pt. drijba
F Chaîne de tronçonneuse

I Taglio per motoseghea
E Cadena de motosierra
CN 蠟沫

COLOR BOX
WITH EURO HOLE



for / dla: YT-84900, YT-84936



for / dla: Dolmar: 109, 110, 111, 112, 113, 114, 115i, 116, ES1800, PS460, PS4600, PS4605, PS500, PS5000, PS5510, PS5100S, PS540; Husqvarna: 154, 257, 440e, 133, 136, 137, 140, 141, 142, 234, 235, 238, 240, 240e, 242, 242XP, 246, 254, 254XP, 261, 262, 338XPT, 339XP, 340, 345, 346, 346XP, 350, 351, 353, 357, 357XP, 359, 36, 365, 372XP, 40, 41, 42, 435, 435E, 44, 444, 445, 445E, 45, 450E, 455 RANCHER, 455E RANCHER, 460 RANCHER, 50, 51, 55, T435; Jonsered: 520, 2012, 2014, 2015, 2016, 2036, 2040, 2041, 2045, 2050, 2051, 2054, 2055, 063, 2141, 2145, 2147, 2149, 2150, 2152, 2153, 2155, 2156, 2159, 2163, 370, 380, 410, 420, 425, 435, 45, 450, 451, 451EVS, 452, 455, 490, 49SP, 50, 51, 510, 52, 521, 525, 535, 590, CS2149W, CS2152W; Makita: 45, DCS430, DCS43001, DCS43001, DCS431, DCS460, DCS4600S, DCS4630, DCS500, DCS5000, DCS5030, DCS520, DCS52001; NAC: NO-CS38, SPS01-45, SPS01-52, SPS02-45, YD 40/45, YD40, YD52; Oleo-Mac: 850, 938, 940, 941, 942, 945, 946, 947, 950, 950 Super, 950A, 951, 952, 956, 962, E300F; Partner: 1650, 365, 400, 405, 410, 450, 460, 465, 470, 495, 500, 510, 540, 545, P500, P5000, P5500

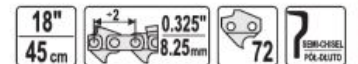

YATO	size / rozmiar	
YT-84943	18" (45 cm)	50

for / dla: YT-84900



for / dla: Dolmar: 109, 110, 111, 112, 113, 114, 115i, 116, ES1800, PS460, PS4600, PS4605, PS500, PS5000, PS5510, PS5100S, PS540; Husqvarna: 154, 257, 440e, 133, 136, 137, 140, 141, 142, 234, 235, 238, 240, 240e, 242, 242XP, 246, 254, 254XP, 261, 262, 338XPT, 339XP, 340, 345, 346, 346XP, 350, 351, 353, 357, 357XP, 359, 36, 365, 372XP, 40, 41, 42, 435, 435E, 44, 444, 445, 445E, 45, 450E, 455 RANCHER, 455E RANCHER, 460 RANCHER, 50, 51, 55, T435; Jonsered: 520, 2012, 2014, 2015, 2016, 2036, 2040, 2041, 2045, 2050, 2051, 2054, 2055, 063, 2141, 2145, 2147, 2149, 2150, 2152, 2153, 2155, 2156, 2159, 2163, 370, 380, 410, 420, 425, 435, 45, 450, 451, 451EVS, 452, 455, 490, 49SP, 50, 51, 510, 52, 521, 525, 535, 590, CS2149W, CS2152W; Makita: 45, DCS430, DCS43001, DCS43001, DCS431, DCS460, DCS4600S, DCS4630, DCS500, DCS5000, DCS5030, DCS520, DCS52001; NAC: NO-CS38, SPS01-45, SPS01-52, SPS02-45, YD 40/45, YD40, YD52; Oleo-Mac: 850, 938, 940, 941, 942, 945, 946, 947, 950, 950 Super, 950A, 951, 952, 956, 962, E300F; Partner: 1650, 365, 400, 405, 410, 450, 460, 465, 470, 495, 500, 510, 540, 545, P500, P5000, P5500



YATO	size / rozmiar	
YT-84944	20" (50 cm)	50

for / dla: YT-84905, YT-84933



for / dla: Dolmar: 109, 110, 111, 112, 113, 114, 115i, 116, PS460, PS4600, S4605, PS500, PS5000, PS510, PS5100S, PS540; Husqvarna: 133, 136, 137, 141, 142, 154, 234, 238, 240, 242, 42XP, 246, 254, 254XP, 257, 261, 262, 338XPT, 339XP, 340, 345, 346, 346XP, 350, 351, 353, 357, 357XP, 359, 36, 65, 40, 41, 42, 435, 435E, 44, 440E, 444, 445, 445E, 45, 450E, 455 RANCHER, 455E RANCHER, 460 RANCHER, 50, 51, 55, T435; Jonsered: 2012, 2014, 2015, 2016, 2036, 2040, 2041, 2045, 2050, 051, 2054, 2055, 2063, 2141, 2145, 2147, 2149, 2150, 2152, 2153, 2155, 2156, 2159, 2163, 370, 380, 410, 420, 425, 435, 45, 450, 451, 451EVS, 452, 455, 490, 49SP, 50, 51, 510, 52, 521, 525, 535, 590, CS2149W, CS2152W; Makita: 45, DCS430, DCS43001, DCS43001, DCS431, DCS460, DCS4600S, DCS4630, DCS500, DCS5000, DCS5030, DCS520, DCS52001; Oleo-Mac: 850, 938, 940, 941, 941C, 942, 945, 946, 947, 950, 950 Super, 950A, 951, 952, 956, 962, E300F, GS350, GS370, GS410CX; Partner: 1200EL, 1400EL, 1450EL, 1500EL, 1650EL, 365, 400, 405, 410, 450, 460, 465, 470, 495, 500, 510, 540, 545, P500, P5000, P5500



YATO	size / rozmiar	
YT-84945	15" (38 cm)	50

for / dla: YT-84925

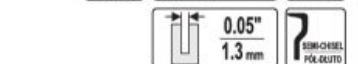

YATO	size / rozmiar	
YT-84948	10" (25 cm)	50

for / dla: YT-84927

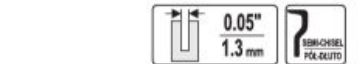
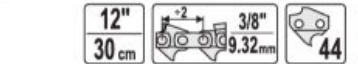

YATO	size / rozmiar	
YT-84949	12" (30 cm)	50

for / dla: Alpina: 270, 280, 330, 380, 432, 438, EURO-40, EURO-45, Elletra 160, Elletra 170, Energy 1.6, Energy 1.8, P360, P370, P390, PR350, Sinergy 35, Sinergy 40; Dolmar: CS2040, PS3300TH; Husqvarna: T425; McCulloch: 3500, 370, 374, 375, 384, 400, 400P, 430, 442, 445, 470, 474, 484, 838, 839, ELECTRA MAC 16E, MAC110, MAC120, MAC130, MAC140, MAC4, MAC6, MAC930, MAC935, MC115, MM30, MM36, PM310, PM320, PM330, PM340, PM36, PM360, PM364, PM370, PM380, PM394, PM400, M470, PM480, PM484, PM510, PM730; Oleo-Mac: 240, OEM200; Partner: 1535EL, 1540, 1540EL, 1640, 1835, 1840, 352, 371, 391, 538E, 542E, P1535, P351; Stihl: 009, 010, 011, 012, 017, 018, 019, 019T, 020, 020T, 021, 021C, 023, 025, 25, MS160, MS170, MS180, MS181, MS191, MS192, MS200, MS200T, MS210, MS211, MS230, MS231, MS241, MS250, MS251, MSE140, MSE200

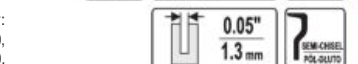

YATO	size / rozmiar	
YT-84950	14" (36 cm)	50

for / dla: YT-84931



for / dla: Al-Ko: 2000, 2300, 25A, E1200, E125, E1400, E1500, KE3500 VARIO, KE4000, KS, KSB; Alpina: 352, 382, A10E, A14E, E120, E130, E150, ELECTRIC, ES182, ES202, KS1400B, KS1500B; Dolmar: 100, 101, 102, 103, 104, 105, 106, 108, 275, 285, CS2040E, S140, ES151, ES152, ES152A, ES153, ES160, ES161, ES162, ES162A, ES163, ES172, ES172A, ES173, ES183, ES2035, ES2040, ES3, ES30, ES37, ES40, ES41, ES6, PS33, PS330, PS3300TH, PS330TH, PS34, PS340, PS341, PS3410, PS344, PS350, PS390, PS400, PS401, PS41, PS45; Echo: CS2600ES, CS260TES, CS2700ES, CS3500ES, CS350WES, CS351WES; Hitachi: CS280A, CS280B, CS350A, CS350B, CS355B; Homelite: 20AV, 23AV, 27, 3300, 3335, 3350, 3550, 3800, 4500, 4550, CS40, HCS3335, HCS4041CA, PS33, RANGER, TIMBERMAN, UT10901, UT10926, UT10974; Husqvarna: 136, 137, 1400, 141, 142, 16, 1600, 23, 243, 315, 316, 318, 320, 321, 33, 333, 334, 335XPT, 338, 338XPT, 36, 41, E16, E316, E317, E321, T425; Jonsered: 2033TH, 2035, 2115, 2115EL, 2116, 2117, 2118EL, 2121, 2135, 2137, 2138, 2139; Makita: 5012, 5016, BUC122RFE, BUC250RDE, DCS230T, DCS232T, DCS300, DCS300S, CS330, DCS330S, DCS34, DCS340, DCS341, DCS3410TH, DCS350, DCS3500, DCS3501, DCS3520A, DCS380, DCS390, DCS400, DCS401, DCS4610, UC3000, UC3030A, UC3500, UC3501, UC3520A, UC3530AK, UC4000, UC4030AK; McCulloch: MS1215, MS1415, MS1425, MS1435, MS1630, MS1635AV, MS1640, MS1645, MS1834N, MS1845J; Oleo-Mac: 931, 932, GS35, GS350, GS370; Partner: 330, 335, 340, 345, 350, 351, 360, 370, 385, 391, 395, P390, P420, P842; Ryobi: APR02, PCN33351

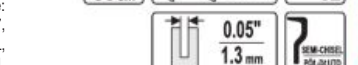

YATO	size / rozmiar	
YT-84951	14" (36 cm)	50

for / dla: YT-849321

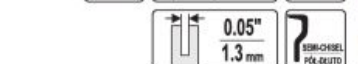
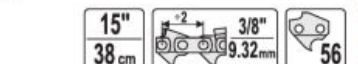

YATO	size / rozmiar	
YT-84952	15" (38 cm)	50

GB Chain for chainsaw
D Kette für Kettensägen
PL Łańcuch łańcuch do pił
RUS Цепь для бензопилы

CZ Řetěz pro řetězové pily
H Lánč lánčfűrész
RO Lant pt. drujba

F Chaîne de tronçonneuse
I Taglio per motoseghea

E Cadena de motosierra
CN 蠟沫

COLOR BOX
WITH EURO HOLE



KICKBACK REDUCTION
REDUKCJA ODRZUTU

VIBRATION REDUCTION
REDUKCJA WIBRACJI

Mn 65

for / dla: YT-84935

for / dla: **Al-Ko:** 2000, 2300, 25A, E1200, E125, E1400, E1500, KE3500 VARIO, KE4000, KS, KSB; **Alpina:** 352, 382, A10E, A14E, E120, E130, E150, ELECTRIC, ES182, ES202, KS1400B, KS1500B; **Dolmar:** 100, 101, 102, 103, 104, 105, 106, 108, 275, 285, CS2040, ES140, ES151, ES152, 152A, ES153, ES160, ES161, ES162, ES162A, ES163, ES172, ES172A, ES173, ES183, ES2035, ES2040, ES3, ES30, ES37, ES40, ES41, ES6, PS33, PS330, PS3300TH, PS3300TH, PS34, PS340, PS341, PS3410, PS344, PS350, PS390, PS400, PS401, PS41, PS45; **Echo:** CS2600ES, CS260TES, CS2700ES, CS3500ES, CS350WES, CS351WES; **Hitachi:** CS280A, CS280B, CS350A, CS350B, CS35B; **Homelite:** 20AV, 23AV, 27, 3300, 3335, 3350, 3550, 3800, 4500, 4550, CS40, HCS3335, HCS4041CA, PS33, RANGER, TIMBERMAN, UT10901, UT10926, UT10974; **Husqvarna:** 136, 137, 1400, 141, 142, 16, 1600, 23, 243, 315, 316, 318, 320, 321, 33, 333, 334, 335XPT, 338, 338XPT, 36, 41, E16, E316, E317, E321, T425; **Jonsered:** 2033TH, 2035, 2115, 2115EL, 2116, 2117, 2118EL, 2121, 2135, 2137, 2138, 2139; **Makita:** 5012, 5016, BU-C122RFE, BUC250RDE, DCS230T, DCS232T, DCS300, DCS300S, DCS330, DCS330S, DCS34, DCS340, DCS341, DCS3410TH, DCS350, DCS3500, DCS3501, DCS3520A, DCS380, DCS390, DCS400, DCS401, DCS4610, UC3000, UC3030A, UC3500, UC3501, UC3520A, UC3530AK, UC4000, UC4030AK; **McCulloch:** MS1215, MS1415, MS1425, MS1435, MS1630, MS1635AV, MS1640, MS1645, MS1834N, MS1845J; **Oleo-Mac:** 931, 932, GS35, GS350, GS370; **Partner:** 330, 335, 340, 345, 350, 351, 360, 370, 385, 391, 395, P390, P420, P842; **Ryobi:** APR02, PCN3335

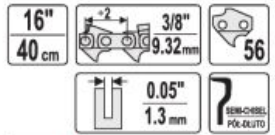

YATO size / rozmiar
YT-84953 16" (40 cm) 50

for / dla: YT-84935

for / dla: **Al-Ko:** 2000, 2300, 25A, E1200, E125, E1400, E1500, KE3500 VARIO, KE4000, KS, KSB; **Alpina:** 352, 382, A10E, A14E, E120, E130, E150, ELECTRIC, ES182, ES202, KS1400B, KS1500B; **Dolmar:** 100, 101, 102, 103, 104, 105, 106, 108, 275, 285, CS2040, ES140, ES151, ES152, ES152A, ES153, ES160, ES161, ES162, ES162A, ES163, ES172, ES172A, ES173, ES183, ES2035, ES2040, ES3, ES30, ES37, ES40, ES41, ES6, PS33, PS330, PS3300TH, PS3300TH, PS34, PS340, PS341, PS3410, PS344, PS350, PS390, PS400, PS401, PS41, PS45; **Echo:** CS2600ES, CS260TES, CS2700ES, CS3500ES, CS350WES, CS351WES; **Hitachi:** CS280A, CS280B, CS350A, CS350B, CS35B; **Homelite:** 20AV, 23AV, 27, 3300, 3335, 3350, 3550, 3800, 4500, 4550, CS40, HCS3335, HCS4041CA, PS33, RANGER, TIMBERMAN, UT10901, UT10926, UT10974; **Husqvarna:** 136, 137, 1400, 141, 142, 16, 1600, 23, 243, 315, 316, 318, 320, 321, 33, 333, 334, 335XPT, 338, 338XPT, 36, 41, E16, E316, E317, E321, T425; **Jonsered:** 2033TH, 2035, 2115, 2115EL, 2116, 2117, 2118EL, 2121, 2135, 2137, 2138, 2139; **Makita:** 5012, 5016, BUC122RFE, BUC250RDE, DCS230T, DCS232T, DCS300, DCS300S, DCS330, DCS330S, DCS34, DCS340, DCS341, DCS3410TH, DCS350, DCS3500, DCS3501, DCS3520A, DCS380, DCS390, DCS400, DCS401, DCS4610, UC3000, UC3030A, UC3500, UC3501, UC3520A, UC3530AK, UC4000, UC4030AK; **McCulloch:** MS1215, MS1415, MS1425, MS1435, MS1630, MS1635AV, MS1640, MS1645, MS1834N, MS1845J; **Oleo-Mac:** 931, 932, GS35, GS350, GS370; **Partner:** 330, 335, 340, 345, 350, 351, 370, 385, 395, P390, P420; **Ryobi:** APR02, PCN3335

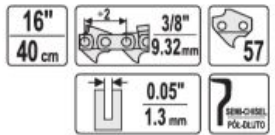

YATO size / rozmiar
YT-84954 16" (40 cm) 50

for / dla: **Stihl:** 029, 031, 032, 034, 036, 038, 039, 041, 042, 044, 045, 046, 048, 056, 064, 066, E15, E20, E220, MS200, MS220, MS290, MS310, MS311, MS340, MS341, MS361, MS362, MS390, MS440, MS441, MS460, MS650, MS660, MS880, MSE200, MSE220

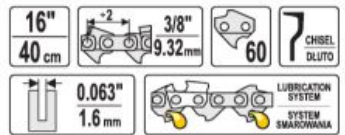

YATO size / rozmiar
YT-84955 16" (40 cm) 50

for / dla: YT-849355

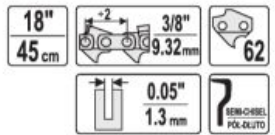

YATO size / rozmiar
YT-84956 18" (45 cm) 50

GB Chain for chainsaw
D Kette für Kettensägen
PL Łańcuch łańcuch do pił
RUS Цепь для бензопилы
CZ Řetěz pro řetězové pily
H Lánč lánčfűrész

RO Lant pt. drujba
F Chaîne de tronçonneuse
I Taglio per motoseghea
E Cadena de motosierra
CN 蠟沫



PAPER SPOOL
& COLOR LABEL
PLUS 30 PCS
OF ADDITIONAL
COLOR BOXES
& POLYBAGS



+30 PCS



KICKBACK REDUCTION
REDUKCJA ODRZUTU

VIBRATION REDUCTION
REDUKCJA WIBRACJI

Mn 65

30 SPARE LINKS
ZAPASOWYCH OGNIV

for / dla: YT-84930, YT-84931, YT-84935

for / dla: **Alpina:** 270, 280, 330, 380, 432, 438, EURO-40, EURO-45, Elletra 160, Elletra 170, Energy 1.6, Energy 1.8, P360, P370, P390, PR350, Sinergy 35, Sinergy 40; **Dolmar:** CS2040, PS3300TH; **Husqvarna:** T425; **McCulloch:** 3500, 370, 374, 375, 384, 400, 400P, 430, 442, 445, 470, 474, 484, 838, 839, ELECTRA MAC 16E, MAC110, MAC120, MAC130, MAC140, MAC4, MAC6, MAC930, MAC935, MC115, MM30, MM36, PM310, PM320, PM330, PM340, PM36, PM360, PM364, PM370, PM380, PM394, PM400, M470, PM480, PM484, PM510, PM730; **Oleo-Mac:** 240, OEM200; **Partner:** 1535EL, 1540, 1540EL, 1640, 1835, 1840, 352, 371, 391, 538E, 542E, P1535, P351; **Stihl:** 009, 010, 011, 012, 017, 018, 019, 019T, 020, 020T, 021, 021C, 023, 025, 25, MS160, MS170, MS180, MS181, MS191, MS192, MS200, MS200T, MS210, MS211, MS230, MS231, MS241, MS250, MS251, MSE140, MSE200

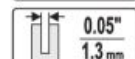

YATO size / rozmiar
YT-84960 1 1

for / dla: YT-84932

for / dla: **Alpina:** P700, P750, P800, PROF700, PROF800; **Dolmar:** 115, 117, 119, 120, 120SI, 122, 123, 1231, 133, 143, 152, 153, 186, 219, CA, KMS4, PS43, PS6000I, PS6000IH, PS6400, PS6400H, PS6800I, PS6800IH, PS7300, PS7300H, PS7900, PS7900H, PS9000, PS9010; **Echo:** CS3500, CS350WES, CS351WE; **Husqvarna:** 1100, 154, 160, 162, 181, 2100XP, 2101, 2101XP, 254, 257, 260, 261, 262, 266, 268, 272, 281XP, 285, 288XP, 298, 298X, 298XG, 3120, 3120XP, 357, 357XP, 359, 362, K34365, 371, 371XP, 371XP, 372, 372XP, 372XPG, 380, 385, 385XP, 394, 394XP, 394XPG, 395, 395XP, 395XPG, 455, 480, 55, 560XP, 562XP, 570, 575, 575XP, 576XP, 61, 64, 65, 66, 70, 77; **Jonsered:** 1020, 2063, 2065, 2071, 2077, 2083, 2094, 2095, 2159, 2163, 2165, 2171, 2186, 625, 630, 630 SUPER, 670, 670 CHAMP, 820; **Makita:** DCS460, DCS4600, DCS500, DCS5030, DCS6400, DCS6401, DCS7301, DCS79001, DCS9000, DCS9010; **Oleo-Mac:** 250A, 251, 252, 254, 261, 264, 271, 272, 284, 350, 355, 460, 480, 481, 482, 484, 970, 971, 980, 981, E300; **Partner:** 550, 660, 710, P770

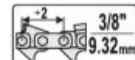

YATO size / rozmiar
YT-84961 1 1

for / dla: YT-84905, YT-84933

for / dla: **Dolmar:** 109, 110, 111, 112, 113, 114, 115, 116, PS460, PS4600, S4605, PS500, PS5000, PS510, PS5100S, PS540; **Husqvarna:** 133, 136, 137, 141, 142, 154, 234, 238, 240, 242, 42XP, 246, 254, 254XP, 257, 261, 262, 338XPT, 339XP, 340, 345, 346, 346XP, 350, 351, 353, 357, 357XP, 359, 36, 65, 40, 41, 42, 435, 435E, 44, 440E, 444, 445, 445E, 45, 450E, 455 RANCHER, 455E RANCHER, 460, 460 RANCHER, 50, 51, 55, T435; **Jonsered:** 2012, 2014, 2015, 2016, 2036, 2040, 2041, 2045, 2050, 051, 2054, 2055, 2063, 2141, 2145, 2147, 2149, 2150, 2152, 2153, 2155, 2156, 2159, 2163, 370, 380, 410, 420, 425, 435, 45, 450, 451, 451EVS, 452, 455, 490, 49SP, 50, 51, 510, 52, 520, 521, 525, 535, 590, CS2149W, CS2152W; **Makita:** 45, DCS430, DCS43001, DCS43001, DCS431, DCS460, DCS4600S, DCS4630, DCS500, DCS5000, DCS5030, DCS520, DCS5200I; **Oleo-Mac:** 850, 938, 940, 941, 941C, 942, 945, 946, 947, 950, 950 Super, 950A, 951, 952, 956, 962, E300F, GS350, GS370, GS410CX; **Partner:** 1200EL, 1400EL, 1450EL, 1500EL, 1650EL, 365, 400, 405, 410, 450, 460, 465, 470, 495, 500, 510, 540, 545, P500, P5000, P5500

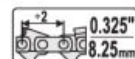

YATO size / rozmiar
YT-84962 1 1

for / dla: YT-84900, YT-84934, YT-84936

for / dla: **Dolmar:** 109, 110, 111, 112, 113, 114, 115, 116, ES1800, PS460, PS4600, PS4605, PS500, PS5000, PS5510, PS5100S, PS540; **Husqvarna:** 154, 257, 440e, 133, 136, 137, 140, 141, 142, 234, 235, 238, 240, 240e, 242, 242XP, 246, 254, 254XP, 261, 262, 338XPT, 339XP, 340, 345, 346, 346XP, 350, 351, 353, 357, 357XP, 359, 36, 365, 372XP, 40, 41, 42, 435, 435E, 44, 444, 445, 445E, 45, 450E, 455 RANCHER, 455E RANCHER, 460 RANCHER, 50, 51, 55, T435; **Jonsered:** 520, 2012, 2014, 2015, 2016, 2036, 2040, 2041, 2045, 2050, 2051, 2054, 2055, 2063, 2141, 2145, 2147, 2149, 2150, 2152, 2153, 2155, 2156, 2159, 2163, 370, 380, 410, 420, 425, 435, 45, 450, 451, 451EVS, 452, 455, 490, 49SP, 50, 51, 510, 52, 521, 525, 535, 590, DCS520, DCS5200I; **NAC:** NO-C328L, SPS01-45, SPS01-52, SPS02-45, YD 40/45, YD40, YD52; **Oleo-Mac:** 850, 938, 940, 941, 942, 945, 946, 947, 950, 950 Super, 950A, 951, 952, 956, 962, E300F; **Partner:** 1650, 365, 400, 405, 410, 450, 460, 465, 470, 495, 500, 510, 540, 545, P500, P5000, P5500

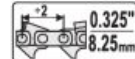

YATO size / rozmiar
YT-84963 1 1

YATO	page/strona	YATO	page/strona	YATO	page/strona	YATO	page/strona	YATO	page/strona	YATO	page/strona	YATO	page/strona	YATO	page/strona	YATO	page/strona	YATO	page/strona
YT-0006	7	YT-01907	8	YT-0333	9	YT-0415	84	YT-04396	53	YT-0498	83	YT-05492	89	YT-06009	337	YT-0659	327		
YT-0007	7	YT-01908	8	YT-0334	9	YT-0416	84	YT-04397	53	YT-0499	83	YT-05493	89	YT-0601	335	YT-06590	327		
YT-0008	7	YT-01909	8	YT-0335	6	YT-0417	84	YT-04398	53	YT-0500	90	YT-05494	89	YT-06011	335	YT-0660	358		
YT-0009	7	YT-0191	8	YT-0336	6	YT-0418	84	YT-04401	53	YT-0501	90	YT-05495	89	YT-06012	336	YT-0661	358		
YT-0010	7	YT-0192	8	YT-0337	6	YT-0419	84	YT-04411	52	YT-0502	90	YT-05496	89	YT-06013	336	YT-06611	358		
YT-0011	7	YT-0193	8	YT-0338	6	YT-0420	84	YT-04412	52	YT-0503	91	YT-05497	89	YT-06014	335	YT-0662	358		
YT-0012	7	YT-0194	8	YT-0339	6	YT-0421	345	YT-04413	52	YT-0504	91	YT-05498	89	YT-06015	338	YT-0663	358		
YT-0013	7	YT-0195	8	YT-0340	6	YT-04211	345	YT-04417	52	YT-0505	90	YT-05499	89	YT-06016	336	YT-06650	388		
YT-0014	7	YT-0196	8	YT-0341	6	YT-04301	52	YT-04418	52	YT-0506	90	YT-05501	89	YT-06017	339	YT-06651	388		
YT-0015	7	YT-0197	8	YT-0342	6	YT-04302	52	YT-04459	83	YT-0507	90	YT-05502	89	YT-06018	337	YT-06652	388		
YT-0016	7	YT-0198	8	YT-0343	6	YT-04303	52	YT-0461	54	YT-0508	90	YT-05503	89	YT-06019	334	YT-06653	388		
YT-0017	7	YT-0199	8	YT-0344	6	YT-04304	52	YT-04620	85	YT-0509	90	YT-05513	89	YT-0602	318	YT-06654	388		
YT-0018	7	YT-0200	8	YT-0345	6	YT-04305	52	YT-04621	85	YT-0511	91	YT-05514	89	YT-0603	321	YT-06655	388		
YT-0019	7	YT-0201	8	YT-0346	6	YT-04306	52	YT-04622	85	YT-0512	91	YT-05515	89	YT-06031	321	YT-06656	388		
YT-0020	7	YT-0202	8	YT-0347	6	YT-04307	52	YT-04623	85	YT-05123	89	YT-05516	89	YT-06033	321	YT-06657	388		
YT-0021	7	YT-0203	8	YT-0348	6	YT-04310	52	YT-04624	85	YT-0519	91	YT-05517	89	YT-0605	354	YT-06658	388		
YT-0022	7	YT-0204	8	YT-0349	6	YT-04311	52	YT-04630	87	YT-0520	49	YT-05518	89	YT-0606	329	YT-06659	388		
YT-0023	7	YT-0205	8	YT-0350	6	YT-04312	52	YT-04631	87	YT-0521	49	YT-05519	89	YT-0607	329	YT-06660	388		
YT-0024	7	YT-0206	8	YT-0351	6	YT-04313	52	YT-04632	87	YT-05211	49	YT-05520	89	YT-0608	329	YT-06661	388		
YT-0025	7	YT-0208	8	YT-0352	6	YT-04314	52	YT-0465	86	YT-05212	49	YT-05521	89	YT-0609	318	YT-06662	388		
YT-0026	7	YT-0209	11	YT-0353	6	YT-04315	52	YT-0466	86	YT-05213	49	YT-05522	89	YT-0610	350	YT-06663	388		
YT-0027	7	YT-0211	11	YT-0354	6	YT-04316	52	YT-0467	86	YT-05214	49	YT-05571	88	YT-0611	351	YT-06664	388		
YT-0028	7	YT-0213	11	YT-0355	6	YT-04317	52	YT-04671	86	YT-05215	49	YT-05572	88	YT-0612	323	YT-0670	343		
YT-0030	7	YT-0215	11	YT-0356	6	YT-04318	52	YT-0468	86	YT-05220	49	YT-05574	88	YT-06122	323	YT-0671	352		
YT-0032	7	YT-0217	11	YT-0357	6	YT-04319	52	YT-04681	86	YT-05221	49	YT-05576	88	YT-0613	323	YT-0672	346		
YT-0036	7	YT-0219	11	YT-0358	6	YT-04320	53	YT-04682	86	YT-05222	49	YT-05577	88	YT-0614	323	YT-06722	376		
YT-0038	7	YT-0222	11	YT-0359	6	YT-04321	53	YT-04683	86	YT-05223	49	YT-05578	88	YT-0615	323	YT-0673	347		
YT-0041	7	YT-0223	11	YT-0360	6	YT-04322	53	YT-04684	86	YT-05224	49	YT-05579	88	YT-06155	323	YT-0674	347		
YT-0046	7	YT-0227	11	YT-0362	6	YT-04323	53	YT-04685	86	YT-05225	49	YT-05581	88	YT-06157	323	YT-0677	332		
YT-0050	7	YT-0228	11	YT-0363	6	YT-04324	53	YT-04686	86	YT-05226	49	YT-05583	88	YT-0616	324	YT-06771	382		
YT-0055	7	YT-0232	11	YT-0365	6	YT-04325	53	YT-04690	86	YT-05227	49	YT-05585	88	YT-06160	323	YT-06772	380		
YT-0060	7	YT-02330	11	YT-0367	9	YT-04326	53	YT-04695	86	YT-05228	49	YT-05586	88	YT-0617	339	YT-06773	380		
YT-0062	7	YT-02331	11	YT-0368	9	YT-04327	53	YT-0470	82	YT-0530	14	YT-05588	88	YT-06175	340	YT-06774	380		
YT-0065	7	YT-02332	11	YT-0369	9	YT-04328	53	YT-04702	80	YT-0534	348	YT-05590	88	YT-06176	339	YT-06775	380		
YT-0067	7	YT-02333	11	YT-0370	9	YT-04329	53	YT-0471	82	YT-05342	340	YT-05591	88	YT-0618	340	YT-06776	380		
YT-0075	7	YT-02334	11	YT-0371	9	YT-04331	53	YT-04712	80	YT-0540	333	YT-05592	88	YT-0619	355	YT-06777	385		
YT-00760	6	YT-0250	11	YT-0372	9	YT-04332	53	YT-0472	82	YT-05430	89	YT-05593	88	YT-0620	322	YT-06780	382		
YT-00761	6	YT-0290	23	YT-0373	9	YT-04341	52	YT-04722	80	YT-05431	89	YT-05594	88	YT-06205	330	YT-06782	384		
YT-00762	6	YT-0291	28	YT-0374	9	YT-04342	52	YT-0473	82	YT-05432	89	YT-05597	88	YT-0621	355	YT-06785	386		
YT-00763	6	YT-0292	33	YT-0375	9	YT-04343	52	YT-0474	82	YT-05433	89	YT-0560	91	YT-0622	342	YT-06786	382		
YT-00764	6	YT-0293	23	YT-0376	9	YT-04344	52	YT-04742	80	YT-05434	89	YT-05601	88	YT-0623	322	YT-06787	384		
YT-00765	6	YT-0294	28	YT-0377	9	YT-04345	52	YT-0475	82	YT-05435	89	YT-05602	88	YT-0624	322	YT-06790	385		
YT-00766	6	YT-0295	33	YT-0378	9	YT-04346	52	YT-04752	80	YT-05436	89	YT-05603	88	YT-06251	322	YT-0680	350		
YT-00767	6	YT-0297	24	YT-0380	10	YT-04350	53	YT-0476	82	YT-05437	89	YT-05604	88	YT-06255	322	YT-06805	350		
YT-00768	6	YT-0298	29	YT-0381	10	YT-04351	53	YT-04762	80	YT-05438	89	YT-05605	88	YT-0627	333	YT-0681	351		
YT-00769	6	YT-0299	34	YT-0383	10	YT-04352	53	YT-0477	82	YT-05439	89	YT-05606	88	YT-06273	333	YT-0682	352		
YT-0135	13	YT-0307	23	YT-0384	10	YT-04353	53	YT-04772	80	YT-05440	89	YT-05607	88	YT-0628	355	YT-06822	353		
YT-0136	13	YT-0308	27	YT-0385	10	YT-04354	53	YT-0478	82	YT-05441	89	YT-05608	88	YT-06288	329	YT-06827	350		
YT-0137	13	YT-0309	33	YT-0386	10	YT-04355	53	YT-04782	80	YT-05442	89	YT-05609	88	YT-0630	330	YT-0683	350		
YT-0138	13	YT-0310	23	YT-0387	10	YT-04356	53	YT-0479	82	YT-05443	89	YT-0561	91	YT-06311	349	YT-0684	350		
YT-01385	13	YT-0311	27	YT-0388	10	YT-04357	53	YT-04792	80	YT-05444	89	YT-05610	88	YT-0632	335	YT-06845	277; 353		
YT-0139	13	YT-0312	33	YT-0389	10	YT-04360	53	YT-0480	82	YT-05445	89	YT-05611	88	YT-0633	338	YT-0685	349		
YT-0140	13	YT-0313	23	YT-0390	10	YT-04370	52	YT-0481	82	YT-05446	89	YT-05615	88	YT-06340	329	YT-0686	349		
YT-0143	13	YT-0314	27	YT-0391	10	YT-04371	52	YT-04812	80	YT-05450	89	YT-0562	91	YT-06341	329	YT-06864	382		
YT-01670	17	YT-0315	33	YT-0392	10	YT-04372	52	YT-0482	82	YT-05451	89	YT-0563	91	YT-0635	333	YT-06865	381		
YT-01671	17	YT-0316	23	YT-0394	10	YT-04373	52	YT-04822	80	YT-05452	89	YT-05810	334	YT-0636	333	YT-06866	127; 387		
YT-01672	17	YT-0317	28	YT-0396	10	YT-04374	52	YT-0483	82	YT-05453	89	YT-05811	334	YT-0637	333	YT-06868	127; 387		
YT-01673	17	YT-0318	33	YT-0398	10	YT-04375	52	YT-04832	80	YT-05454	89	YT-05812	334	YT-0638	324	YT-06870	127; 387		
YT-01674	17	YT-0319	23	YT-0400	84	YT-04381	52	YT-0484	83	YT-05455	89	YT-05815	334	YT-0640	319	YT-06871	381		
YT-01675	17	YT-0320	28	YT-0404	79	YT-04382	52	YT-0485	79	YT-05456	89	YT-05816	334	YT-0641	319	YT-06872	381		
YT-01676	17	YT-0321	33	YT-0405	79	YT-04383	52	YT-0486	79	YT-05457	89	YT-05817	334	YT-0642	324	YT-06873	384		
YT-01677	17	YT-0322	23	YT-04051	79	YT-04384	52	YT-0487	79	YT-05458	89	YT-0585	322	YT-0643	356	YT-06875	383		
YT-01678	17	YT-0323	28	YT-04052	79	YT-04385	52	YT-0488	83	YT-05459	89	YT-0590	321	YT-0645	331	YT-06876	386		
YT-01679	17	YT-0324	33	YT-0406	79	YT-04386	52	YT-0489	83	YT-05460	89	YT-0591	321	YT-0646	331	YT-06877	386		
YT-0170	13	YT-0325	23	YT-0407	79	YT-04387	52	YT-0490	83	YT-05461	89	YT-0593	68; 349	YT-0647	331	YT-06878	385		
YT-0171	13	YT-0326	28	YT-0408	79	YT-04388	52	YT-0491	83	YT-05462	89	YT-0594	311	YT-06475	333	YT-06879	386		
YT-0172	13	YT-0327	33	YT-0409	79	YT-04390	53	YT-0492	83	YT-05463	89	YT-0595	311	YT-0648	332	YT-06880	385		

YATO	page/strona	YATO	page/strona	YATO	page/strona	YATO	page/strona	YATO	page/strona	YATO	page/strona	YATO	page/strona	YATO	page/strona	YATO	page/strona	YATO	page/strona
YT-14421	47	YT-1552	15	YT-1663	9	YT-1766	162; 368	YT-1940	95	YT-2058	100	YT-21014	25; 113	YT-2145	102	YT-22255	107; 205		
YT-14431	35	YT-1553	15	YT-1664	9	YT-1767	162; 368	YT-1941	95	YT-2060	100	YT-21016	25; 113	YT-2146	102	YT-22256	107; 205		
YT-14451	35	YT-1554	15	YT-1665	9	YT-1768	162; 368	YT-1942	95	YT-2061	100	YT-21017	25; 113	YT-2147	102	YT-22260	107; 206		
YT-14461	35	YT-1555	15	YT-1666	9	YT-1769	162; 368	YT-1943	95	YT-2063	100	YT-21018	25; 113	YT-2151	103	YT-2228	190; 207		
YT-14471	36	YT-1556	15	YT-1667	9	YT-17695	368	YT-1944	95	YT-2064	100	YT-21019	25; 113	YT-2152	103	YT-2229	190; 207		
YT-14481	36	YT-1557	15	YT-1669	9	YT-18400	174	YT-1945	95	YT-2066	96	YT-21021	25; 113	YT-2153	103	YT-2230	190; 207		
YT-14491	35	YT-1558	15	YT-1670	9	YT-1843	174	YT-1946	95	YT-2067	96	YT-21022	25; 113	YT-2155	103	YT-2231	190; 207		
YT-14501	36	YT-1559	15	YT-1671	9	YT-1844	174	YT-1947	95	YT-2069	106; 206	YT-21030	29; 113	YT-2156	103	YT-22312	190; 207		
YT-1460	30	YT-1565	15	YT-1672	9	YT-1845	174	YT-1948	95	YT-2070	106; 206	YT-21031	29; 113	YT-21570	104; 394	YT-22313	191; 208		
YT-1461	30	YT-1566	15	YT-1673	9	YT-1846	174	YT-1949	100	YT-2071	17	YT-21032	29; 113	YT-21582	157; 396	YT-22314	191; 208		
YT-1462	30	YT-1567	15	YT-1674	9	YT-1847	174	YT-1950	99	YT-2072	17	YT-21033	29; 113	YT-2160	105; 394	YT-22315	191; 208		
YT-1463	30	YT-1571	16	YT-1675	9	YT-1848	174	YT-1951	99	YT-2073	17	YT-21034	29; 113	YT-2161	105; 394	YT-22316	191; 208		
YT-1464	30	YT-1573	16	YT-1676	9	YT-1851	174	YT-1952	99	YT-2074	17	YT-21036	29; 113	YT-2162	105; 394	YT-22317	191; 208		
YT-1465	30	YT-1574	16	YT-1677	9	YT-1852	174	YT-1953	99	YT-2075	17	YT-21037	29; 113	YT-2165	17	YT-22318	191; 208		
YT-1466	30	YT-1575	16	YT-1678	9	YT-1853	174	YT-1954	99	YT-2080	97	YT-21038	29; 113	YT-21650	17	YT-2232	191; 208		
YT-1467	30	YT-1576	16	YT-1679	9	YT-1854	174	YT-1956	99	YT-2081	97	YT-21039	29; 113	YT-21651	17	YT-2233	191; 208		
YT-1468	30	YT-1577	16	YT-1680	9	YT-1855	174	YT-1960	170; 243; 397	YT-2082	97	YT-21041	29; 113	YT-21652	17	YT-22338	191; 208		
YT-1469	30	YT-1578	16	YT-1681	9	YT-1856	174			YT-2083	97	YT-21042	29; 113	YT-21653	17	YT-2234	191; 208		
YT-1470	30	YT-1601	12	YT-1682	9	YT-18600	121; 175	YT-1961	171; 244; 398	YT-2084	97	YT-21044	29; 113	YT-21654	17	YT-2235	191; 208		
YT-1471	30	YT-1602	12	YT-1683	9	YT-18602	121; 175			YT-2085	97	YT-21047	29; 113	YT-21655	17	YT-22353	190; 207		
YT-1472	30	YT-1603	12	YT-1684	9	YT-18610	120; 175	YT-1962	171; 243; 397	YT-2086	97	YT-21050	29; 113	YT-21656	17	YT-22354	190; 207		
YT-1473	30	YT-1604	12	YT-1685	9	YT-18611	120; 175			YT-2090	106; 206	YT-21052	29; 113	YT-21657	17	YT-22355	190; 207		
YT-1474	30	YT-1605	12	YT-1686	9	YT-18612	120; 175	YT-1963	172; 245; 399	YT-2091	106; 206	YT-21055	26; 113	YT-21658	17	YT-22360	212		
YT-1475	30	YT-1606	12	YT-1687	9	YT-18970	173; 246; 400			YT-20911	106; 206	YT-21056	26; 113	YT-2166	17	YT-22361	212		
YT-1476	30	YT-1607	12	YT-1688	9		YT-1964	172; 245; 399	YT-20940	17; 112	YT-21057	31; 113	YT-2167	17	YT-22373	209			
YT-1478	30	YT-1608	12	YT-1690	9	YT-18975			173; 246; 400			YT-20941	17; 112	YT-21058	31; 113	YT-2168	17	YT-22374	209
YT-1480	30	YT-1609	12	YT-17000	371		YT-1965	172; 245; 399	YT-20942	17; 112	YT-21071	28; 113	YT-2170	17	YT-22380	247			
YT-1481	30	YT-1610	12	YT-17001	371	YT-18977			173; 246; 400			YT-20950	12; 112	YT-21072	33; 113	YT-2171	17	YT-2240	116
YT-1501	86	YT-1611	12	YT-17002	371		YT-1966	121; 170	YT-20951	12; 112	YT-21080	52; 114	YT-2172	17	YT-2242	116			
YT-1502	86	YT-1612	12	YT-17003	371	YT-1900	172; 244; 398	YT-1967	121; 170	YT-20952	12; 112	YT-21081	52; 114	YT-2173	17	YT-22422	116		
YT-1503	86	YT-1613	12	YT-17004	371			YT-1968	121; 170	YT-20953	12; 112	YT-21082	52; 114	YT-21735	211	YT-2243	116		
YT-1505	86	YT-1614	12	YT-17005	371	YT-1901	172; 244; 398	YT-1969	121; 170	YT-20954	12; 112	YT-21083	52; 114	YT-21740	212	YT-2244	116		
YT-1507	86	YT-1615	12	YT-17006	371			YT-19691	120	YT-20955	12; 112	YT-21085	53; 114	YT-21741	212	YT-2245	114		
YT-1508	86	YT-1616	12	YT-17007	371	YT-1902	172; 244; 398	YT-1970	172; 245; 399	YT-20956	12; 112	YT-21086	53; 114	YT-21742	212	YT-2246	115		
YT-1511	86	YT-1617	12	YT-17008	371					YT-20957	12; 112	YT-21087	53; 114	YT-21743	212	YT-2247	116		
YT-1512	86	YT-1618	12	YT-17009	371	YT-1910	170; 243; 397	YT-1974	120; 188	YT-20958	12; 112	YT-21088	53; 114	YT-21744	212	YT-2249	116		
YT-1513	86	YT-1619	12	YT-17015	371			YT-1976	175	YT-20959	12; 112	YT-21089	53; 114	YT-21745	212	YT-2250	115		
YT-1515	86	YT-1620	12	YT-1702	371	YT-1911	171; 244; 398	YT-19763	188	YT-20960	12; 112	YT-21095	16; 112	YT-21746	212	YT-2251	115		
YT-1517	86	YT-1621	12	YT-17025	371			YT-19764	188	YT-20961	12; 112	YT-21096	16; 112	YT-21747	212	YT-2254	117		
YT-1518	86	YT-1622	12	YT-1704	371	YT-1912	171; 243; 397	YT-19765	188	YT-20962	12; 112	YT-21120	87; 114	YT-2180	209	YT-2255	115		
YT-15271	16	YT-1627	14	YT-17045	371			YT-19766	188	YT-20963	12; 112	YT-21121	87; 114	YT-2182	209	YT-2256	115		
YT-15272	16	YT-1628	14	YT-1706	371	YT-1913	171; 243; 397	YT-19767	188	YT-20964	12; 112	YT-21122	87; 114	YT-21840	209	YT-2260	119		
YT-15273	16	YT-1629	14	YT-1707	371			YT-1988	102	YT-20965	12; 112	YT-21123	87; 114	YT-21842	209	YT-2261	119		
YT-15274	16	YT-1630	14	YT-17075	371	YT-1914	171; 244; 398	YT-1989	102	YT-20966	12; 112	YT-21125	87; 114	YT-21843	209	YT-2262	119		
YT-15275	16	YT-1631	14	YT-1709	371			YT-1990	102	YT-20967	12; 112	YT-21126	87; 114	YT-21844	209	YT-2263	119		
YT-15276	16	YT-1632	14	YT-1711	372	YT-1915	170; 243; 397	YT-1991	102	YT-20968	12; 112	YT-21127	87; 114	YT-21845	209	YT-2266	118		
YT-15277	16	YT-1633	14	YT-1713	372			YT-1992	102	YT-20969	12; 112	YT-21141	121; 170	YT-21846	209	YT-2267	118		
YT-15278	16	YT-1634	14	YT-1714	372	YT-1916	171; 244; 398	YT-1993	102	YT-20980	11; 112	YT-21151	98; 111	YT-21850	209	YT-2268	119		
YT-15279	16	YT-1635	14	YT-1715	372			YT-1994	102	YT-20981	11; 112	YT-21152	98; 111	YT-21851	209	YT-2270	118		
YT-15280	16	YT-1636	14	YT-1720	372	YT-1918	170; 243; 397	YT-1995	102	YT-20982	11; 112	YT-21153	98; 111	YT-21852	209	YT-2274	119		
YT-15281	16	YT-1637	14	YT-17205	372			YT-2006	95	YT-20983	11; 112	YT-21154	98; 111	YT-22000	107; 205	YT-2275	119		
YT-15282	16	YT-1638	14	YT-17207	372	YT-1919	171; 244; 398	YT-2007	95	YT-20984	11; 112	YT-21155	98; 111	YT-22001	107; 205	YT-2276	119		
YT-15283	16	YT-1639	14	YT-1721	372			YT-2008	95	YT-20985	11; 112	YT-21158	98; 111	YT-22002	107; 205	YT-2278	118		
YT-15284	16	YT-1640	14	YT-17211	373	YT-1920	172; 245; 399	YT-2016	95	YT-20986	11; 112	YT-21159	98; 111	YT-22005	107; 205	YT-2279	119		
YT-15291	16	YT-1641	14	YT-17213	373			YT-2018	95	YT-20987	11; 112	YT-21160	98; 111	YT-2201	106; 204	YT-2280	120		
YT-15292	16	YT-1642	14	YT-17260	371	YT-1922	171; 243; 397	YT-2026	95	YT-20988	11; 112	YT-21161	98; 111; 206	YT-2203	106; 204	YT-22860	117		
YT-15293	16	YT-1644	14	YT-17261	371			YT-2028	95	YT-20989	11; 112			YT-2204	106; 204	YT-22861	117		
YT-1532	87	YT-1647	14	YT-17262	371	YT-1923	171; 243; 397	YT-2029	96	YT-20990	11; 112	YT-21190	114; 142	YT-2205	106; 204	YT-22862	117		
YT-1533	87	YT-1649	14	YT-17310	373			YT-2030	96	YT-20991	11; 112	YT-21191	98; 111	YT-2206	106; 204	YT-22870	174		
YT-1534	87	YT-1650	14	YT-17311	373	YT-1924	172; 245; 399	YT-2031	96	YT-20992	11; 112	YT-21200	120; 188	YT-2210	205	YT-22871	174		
YT-1535	87	YT-1651	9	YT-17312	373			YT-2036	95	YT-20993	11; 112	YT-21210							

YATO	page/strona	YATO	page/strona	YATO	page/strona	YATO	page/strona	YATO	page/strona	YATO	page/strona	YATO	page/strona	YATO	page/strona		
YT-2300	115	YT-24243	281	YT-25837	76	YT-25989	72	YT-2821	77; 110	YT-2947	160	YT-30370	262	YT-3261	155	YT-3374	159
YT-2302	115	YT-24301	368	YT-25838	76	YT-25990	72	YT-2822	77; 110	YT-2948	160	YT-30375	262	YT-3262	155	YT-3376	159
YT-2305	116	YT-2449	103	YT-25839	76	YT-25991	72	YT-2823	77; 110	YT-2949	160	YT-30400	263	YT-3263	155	YT-3377	159
YT-2307	115	YT-2450	103	YT-25840	76	YT-25992	72	YT-2824	77; 110	YT-2950	160	YT-30425	261	YT-3264	155	YT-3380	159
YT-2313	118	YT-2451	103	YT-25852	76	YT-25993	72	YT-2825	77; 110	YT-2951	160	YT-30427	261	YT-3265	155	YT-3381	159
YT-2316	119	YT-2452	103	YT-25853	76	YT-25994	72	YT-2826	77; 110	YT-2952	160	YT-30430	262	YT-3266	155	YT-33950	177
YT-2319	118	YT-2453	103	YT-25854	76	YT-25995	72	YT-2827	77; 110	YT-2953	160	YT-3071	248	YT-3267	155	YT-3400	178
YT-2340	278	YT-2459	103	YT-25855	76	YT-25996	72	YT-2828	77; 110	YT-2954	160	YT-3072	248	YT-3268	155	YT-3401	178
YT-2341	278	YT-2460	103	YT-25856	76	YT-25997	72	YT-28290	77; 110	YT-2955	160	YT-3073	248	YT-3269	155	YT-3402	178
YT-2346	278	YT-2461	104; 394	YT-25857	76	YT-25998	73	YT-28293	77; 110	YT-2956	160	YT-3074	248	YT-3270	155	YT-3403	178
YT-2357	278	YT-2463	104; 394	YT-25861	76	YT-2601	75	YT-28300	122	YT-2957	160	YT-3076	248	YT-3271	155	YT-3404	178
YT-2370	277	YT-2466	104; 394	YT-25862	76	YT-2602	75	YT-28310	122	YT-2958	160	YT-3077	248	YT-3272	155	YT-3405	178
YT-23701	277	YT-2468	104; 394	YT-25863	76	YT-2606	75	YT-28311	122	YT-2959	160	YT-3078	248	YT-3273	155	YT-3407	178
YT-23702	277	YT-2469	104; 394	YT-25900	72	YT-2608	75	YT-28312	122	YT-2960	161	YT-3079	248	YT-3274	155	YT-3408	178
YT-23703	277	YT-2473	103	YT-25901	72	YT-2609	75	YT-2861	122; 256	YT-2961	161	YT-3081	248	YT-3275	155	YT-3409	178
YT-2371	277	YT-2476	103	YT-25902	72	YT-2610	75	YT-2862	122; 256	YT-2962	161	YT-3082	248	YT-3276	155	YT-3410	178
YT-2372	277	YT-2482	106; 204	YT-25903	72	YT-2612	75	YT-28630	122; 256	YT-2963	161	YT-3083	248	YT-3277	155	YT-3411	178
YT-2373	278	YT-2483	106; 204	YT-25904	72	YT-2613	75	YT-28631	122	YT-2964	161	YT-3084	248	YT-3278	155	YT-3412	178
YT-23731	278	YT-2484	106; 204	YT-25905	72	YT-2614	75	YT-2864	122	YT-2965	161	YT-3101	175	YT-3279	155	YT-3413	178
YT-23732	278	YT-2485	106; 204	YT-25906	72	YT-2615	75	YT-2865	367	YT-2966	161	YT-3102	175	YT-3280	155	YT-3414	178
YT-23733	278	YT-2488	106; 204	YT-25907	72	YT-2618	75	YT-2866	367	YT-2967	161	YT-3103	175	YT-3281	155	YT-3415	178
YT-2374	279	YT-2489	106; 204	YT-25908	72	YT-2633	75	YT-28920	156; 395	YT-2968	161	YT-3106	175	YT-3282	155	YT-3416	178
YT-2375	279	YT-2490	106; 204	YT-25909	72	YT-2634	75	YT-28921	156; 395	YT-2969	161	YT-3107	175	YT-3283	155	YT-3417	178
YT-2376	279	YT-2491	106; 204	YT-25910	72	YT-2635	75	YT-28950	156	YT-2970	161	YT-3108	175	YT-3284	155	YT-3421	178
YT-2380	279	YT-2492	106; 204	YT-25911	72	YT-2636	75	YT-28951	156	YT-2971	161	YT-3130	176	YT-3285	155	YT-3434	178
YT-2381	279	YT-2493	106; 204	YT-25912	72	YT-2640	75	YT-28952	156	YT-2972	161	YT-31303	175	YT-3286	155	YT-3435	178
YT-2382	279	YT-2494	106; 204	YT-25913	72	YT-2641	75	YT-28953	156	YT-2973	161	YT-31310	176	YT-3287	155	YT-3440	178
YT-2383	280	YT-2510	318	YT-25914	72	YT-2642	75	YT-28954	156	YT-2974	161	YT-3133	176	YT-3288	155	YT-3441	178
YT-2384	280	YT-25105	318	YT-25920	72	YT-2643	75	YT-28955	156	YT-2975	160	YT-3134	176	YT-3289	155	YT-3442	178
YT-2385	280	YT-2511	317	YT-25921	72	YT-2644	75	YT-28956	156	YT-2976	161	YT-31343	176	YT-3290	155	YT-3443	178
YT-2390	281	YT-2512	317	YT-25922	72	YT-2645	75	YT-28957	156	YT-2977	161	YT-3150	176	YT-3291	155	YT-3444	178
YT-2391	281	YT-2513	317	YT-25923	72	YT-2647	75	YT-28958	156	YT-2978	160	YT-3160	177	YT-3292	155	YT-3445	178
YT-2392	281	YT-2514	317	YT-25924	72	YT-2648	75	YT-28959	156	YT-2979	160	YT-3161	177	YT-3293	155	YT-3460	177
YT-2393	281	YT-25145	317; 328	YT-25925	72	YT-2649	75	YT-28960	156	YT-2980	162	YT-3163	177	YT-3294	155	YT-3461	177
YT-2394	281	YT-2515	317	YT-25926	72	YT-2650	75	YT-28961	156	YT-2981	162	YT-3200	176; 498	YT-3295	155	YT-3462	177
YT-2395	281	YT-2516	317	YT-25927	72	YT-2655	75	YT-28962	156	YT-2982	162	YT-3201	176; 498	YT-3296	155	YT-34680	179
YT-2396	281	YT-2517	317	YT-25928	72	YT-2657	75	YT-28963	156	YT-2983	162	YT-3202	176; 498	YT-3297	155	YT-34681	179
YT-2397	281	YT-2518	317	YT-25929	72	YT-2658	75	YT-28964	156	YT-2984	162	YT-3203	176; 498	YT-3298	155	YT-34682	179
YT-2398	281	YT-2519	317	YT-25930	72	YT-2661	75	YT-28965	156	YT-2985	162	YT-3204	176; 498	YT-3299	155	YT-34683	179
YT-2399	281	YT-2520	317	YT-25931	72	YT-2663	75	YT-28966	156	YT-2986	162	YT-3221	177; 498	YT-3300	155	YT-34684	180
YT-2401	281	YT-2521	317	YT-25932	72	YT-2665	75	YT-28967	156	YT-2987	162	YT-3222	177; 498	YT-3303	159	YT-34685	180
YT-2402	281	YT-2522	317	YT-25933	72	YT-2667	75	YT-2900	204	YT-2988	162	YT-3223	177; 498	YT-3304	159	YT-34686	180
YT-2403	281	YT-2523	317	YT-25934	72	YT-2668	75	YT-29001	204	YT-2989	162	YT-3224	177; 498	YT-3306	159	YT-34687	180
YT-2404	281	YT-25331	328	YT-25940	72	YT-2670	76	YT-2910	204	YT-2990	162	YT-3230	177; 498	YT-3308	159	YT-34688	181
YT-2405	281	YT-2535	354	YT-25941	72	YT-2741	75	YT-2911	204	YT-2991	162	YT-3231	177; 498	YT-3311	159	YT-34689	181
YT-2406	281	YT-2536	354	YT-25942	72	YT-2742	75	YT-2912	204	YT-2992	162	YT-3232	177; 498	YT-3313	159	YT-34690	181
YT-2407	281	YT-2537	354	YT-25943	72	YT-2743	75	YT-2913	204	YT-2993	162	YT-3233	177; 498	YT-3315	159	YT-34691	181
YT-24091	282	YT-25391	320	YT-25950	72	YT-2744	75	YT-2914	204	YT-2994	162	YT-3234	177; 498	YT-3317	159	YT-35850	189
YT-24092	282	YT-2540	319	YT-25951	72	YT-2745	75	YT-2916	204	YT-2995	162	YT-3236	154	YT-3318	159	YT-35851	189
YT-24093	282	YT-2541	320	YT-25952	72	YT-2746	75	YT-2917	204	YT-2996	162	YT-3237	154	YT-3321	159	YT-35852	189
YT-24094	282	YT-2542	320	YT-25953	72	YT-2748	75	YT-2918	204	YT-2997	162	YT-3238	154	YT-3322	159	YT-35853	189
YT-24095	282	YT-2543	320	YT-25954	72	YT-2750	75	YT-2919	204	YT-29980	264	YT-3239	154	YT-3323	159	YT-35854	189
YT-24100	281	YT-2544	354	YT-25955	72	YT-2752	75	YT-2920	204	YT-29982	264	YT-3240	154	YT-3324	159	YT-35855	189
YT-24101	281	YT-2546	354	YT-25956	72	YT-2753	75	YT-2921	204	YT-29984	264	YT-3241	154	YT-3327	159	YT-35856	189
YT-24102	281	YT-2547	354	YT-25957	72	YT-2754	75	YT-29220	212	YT-3001	262	YT-3242	154	YT-3329	159	YT-35857	189
YT-24103	281	YT-25480	328	YT-25958	72	YT-2756	75	YT-29222	212	YT-3002	262	YT-3243	154	YT-3330	159	YT-35858	189
YT-24201	280	YT-25802	76	YT-25959	72	YT-2797	78	YT-2926	160	YT-3003	262	YT-3244	154	YT-3332	159	YT-35859	189
YT-24202	280	YT-25803	76	YT-25960	72	YT-2798	78	YT-2930	160	YT-3004	262	YT-3245	154	YT-3333	159	YT-35860	189
YT-24203	280	YT-25804	76	YT-25961	72	YT-28003	79	YT-2931	160	YT-3005	262	YT-3246	154	YT-3334	159	YT-35861	189
YT-24204	280	YT-25805	76	YT-25965	73	YT-2801	79	YT-2932	160	YT-30061	262	YT-3247	154	YT-3336	159	YT-35862	189
YT-24205	280	YT-25806	76	YT-25966	73	YT-28015	79	YT-2933	160	YT-30062	262	YT-3248	154	YT-3338	159	YT-35863	189
YT-24206	280	YT-25807	76	YT-25967	73	YT-2802	79	YT-2934	160	YT-30063	262	YT-3249	154	YT-3343	159	YT-35864	189
YT-24207	280	YT-25808	76	YT-25968	74	YT-2806	78	YT-2935	160	YT-30064	262	YT-3250	154	YT-3345	159	YT-35865	189
YT-24208	280	YT-25809	76	YT-25971	74	YT-2810	79	YT-2937	160	YT-30071	262	YT-3251	154	YT-3346	159	YT-35866	189
YT-24209	280	YT-25810	76	YT-25972	78	YT-2811	79	YT-2939	160	YT-30072	262	YT-3252	154	YT-3349	159	YT-35867	189
YT-24220	280	YT-25811	76	YT-25980	73	YT-2812	79	YT-2940	160	YT-30073	262	YT-3253	154	YT-3350	159	YT-35868	189
YT-24221	280	YT-25831	76	YT-25981	74	YT-2815	77; 110	YT-2941	160	YT-30074	262	YT-3254	154	YT-3351	159	YT-35869	189
YT-24224	280	YT-25832	76</														

YATO	page/strona	YATO	page/strona	YATO	page/strona	YATO	page/strona	YATO	page/strona	YATO	page/strona	YATO	page/strona	YATO	page/strona	YATO	page/strona	YATO	page/strona
YT-35881	189	YT-37141	235	YT-38801	43	YT-4183	152	YT-4217	152	YT-4452	149	YT-44780	151	YT-4630	134; 393	YT-4764	184		
YT-3590	189	YT-37160	236	YT-38811	45	YT-4184	152	YT-4218	152	YT-4453	149	YT-44781	151	YT-4631	134; 393	YT-4766	184		
YT-3591	189	YT-37161	236	YT-38821	37	YT-4185	152	YT-4219	152	YT-4454	149	YT-44782	151	YT-4632	134; 393	YT-4767	184		
YT-3600	218	YT-37164	236	YT-38831	42	YT-4186	152	YT-4220	152	YT-4455	149	YT-44783	151	YT-4633	134; 393	YT-4768	184		
YT-36007	218	YT-37170	236	YT-38841	46	YT-4187	152	YT-4221	152	YT-4456	149	YT-44784	151	YT-4634	134; 393	YT-4769	184		
YT-36011	218	YT-3725	156	YT-38861	37	YT-4188	152	YT-4222	152	YT-4457	149	YT-44785	151	YT-46750	138	YT-47695	182		
YT-36012	218	YT-3726	156	YT-38872	44	YT-4189	152	YT-4223	152	YT-4458	149	YT-44786	151	YT-46800	138	YT-47696	182		
YT-36060	218	YT-3727	156	YT-38875	43	YT-4190	152	YT-4224	152	YT-4460	149	YT-44787	151	YT-46801	138	YT-47697	182		
YT-36070	218	YT-3728	156	YT-38881	44	YT-4191	152	YT-4225	152	YT-4461	149	YT-44789	151	YT-46802	138	YT-47698	182		
YT-3609	218	YT-37301	234	YT-38891	41	YT-4192	152	YT-4226	152	YT-4462	149	YT-44800	156	YT-46803	138	YT-47770	168		
YT-36092	218	YT-37317	234	YT-38901	42	YT-41930	153	YT-4227	152	YT-44630	150	YT-44801	156	YT-46804	138	YT-4901	8		
YT-36095	219	YT-3735	189; 231; 236	YT-38911	39	YT-41931	153	YT-4228	152	YT-44631	150	YT-44802	156	YT-46810	138	YT-4902	8		
YT-3610	219			YT-38920	47	YT-41932	153	YT-4229	152	YT-44632	150	YT-44803	156	YT-46811	138	YT-4903	8		
YT-36112	219	YT-3736	189; 231; 236	YT-38928	48	YT-41933	153	YT-4230	152	YT-44633	150	YT-44804	156	YT-46812	138	YT-4904	8		
YT-36119	219			YT-38931	45	YT-41934	153	YT-4350	155	YT-44634	150	YT-44805	156	YT-46813	138	YT-4905	8		
YT-3612	219	YT-3740	188	YT-38941	46	YT-41935	153	YT-4351	155	YT-44635	150	YT-44806	156	YT-46814	138	YT-4906	8		
YT-36125	220	YT-37440	241	YT-3895	309	YT-41936	153	YT-4352	155	YT-44637	150	YT-44809	156	YT-46820	138	YT-4907	8		
YT-36127	219	YT-37444	241	YT-38951	310	YT-41937	153	YT-4353	155	YT-44639	150	YT-4491	132	YT-46821	138	YT-4908	8		
YT-36128	219	YT-37450	241	YT-39009	49; 127	YT-41938	153	YT-4354	155	YT-44640	150	YT-4492	132	YT-46822	138	YT-4909	8		
YT-36129	220	YT-37690	58	YT-39280	48	YT-41939	153	YT-4355	155	YT-44642	150	YT-4493	132	YT-46823	138	YT-4910	8		
YT-36140	219	YT-3801	25	YT-4020	149	YT-41940	153	YT-4356	155	YT-44643	150	YT-4494	132	YT-46831	138	YT-4911	8		
YT-36171	221; 283	YT-3802	25	YT-4025	149	YT-41941	153	YT-4357	155	YT-44645	150	YT-4495	132	YT-46832	138	YT-4912	8		
YT-36177	221; 283	YT-3803	25	YT-4030	149	YT-41942	153	YT-4358	155	YT-44650	150	YT-4496	132	YT-46833	138	YT-4915	14		
YT-3618	221; 283	YT-3804	25	YT-4032	149	YT-41943	153	YT-4359	155	YT-44652	150	YT-4497	132	YT-46834	138	YT-4916	14		
YT-36420	383	YT-3805	25	YT-4035	149	YT-41944	153	YT-4361	153	YT-44653	150	YT-4498	132	YT-46835	138	YT-4917	14		
YT-36451	220	YT-3806	25	YT-4040	149	YT-41945	153	YT-4362	153	YT-44654	150	YT-4499	132	YT-46836	138	YT-4918	14		
YT-36452	220	YT-3807	25	YT-4042	149	YT-41946	153	YT-4363	153	YT-44655	150	YT-4500	132	YT-46880	137	YT-4919	14		
YT-36453	220	YT-3808	25	YT-4045	149	YT-41947	153	YT-4364	153	YT-44656	150	YT-4501	132	YT-4690	137	YT-4920	14		
YT-36454	220	YT-3809	25	YT-4048	149	YT-41948	153	YT-4367	153	YT-44657	150	YT-4502	132	YT-4691	137	YT-4921	14		
YT-36460	220	YT-3810	25	YT-4050	149	YT-41949	153	YT-4369	153	YT-44658	150	YT-4503	132	YT-4692	137	YT-4922	14		
YT-36470	220	YT-3811	25	YT-4052	149	YT-41950	153	YT-4370	153	YT-44659	150	YT-4504	132	YT-4693	137	YT-4923	14		
YT-36471	220	YT-3812	25	YT-4055	149	YT-41951	153	YT-4375	153	YT-44660	150	YT-4505	132	YT-4694	138	YT-4925	14		
YT-36472	220	YT-3813	25	YT-4060	149	YT-41952	153	YT-4376	153	YT-44661	150	YT-4506	132	YT-4695	138	YT-4926	14		
YT-36473	220	YT-3814	25	YT-4065	149	YT-41953	153	YT-4379	153	YT-44662	150	YT-4507	132	YT-4700	135	YT-4927	14		
YT-36474	220	YT-3820	25	YT-4070	149	YT-41954	153	YT-4380	153	YT-44663	150	YT-4508	132	YT-4705	135	YT-4928	14		
YT-36475	220	YT-3821	25	YT-4075	149	YT-41955	153	YT-4383	153	YT-44664	150	YT-4509	132	YT-4710	135	YT-4937	14		
YT-36476	220	YT-3822	25	YT-4080	149	YT-41956	153	YT-4385	153	YT-44666	150	YT-4510	132	YT-4711	136	YT-4945	15		
YT-36480	220	YT-3823	25	YT-4085	149	YT-41957	153	YT-4390	153	YT-44667	150	YT-4515	134; 393	YT-4712	136	YT-5038	10		
YT-36481	220	YT-3824	25	YT-4090	149	YT-41958	153	YT-4400	158	YT-44668	150	YT-4516	134; 393	YT-47121	136	YT-5130	105; 395		
YT-36500	223	YT-3825	25	YT-4100	149	YT-41959	153	YT-4401	158	YT-44673	151	YT-4518	134; 393	YT-4713	137	YT-5131	105; 395		
YT-36501	223	YT-3826	25	YT-4110	149	YT-41960	153	YT-4402	158	YT-44674	151	YT-4519	134; 393	YT-4714	137	YT-51311	105; 395		
YT-36502	222	YT-3827	25	YT-4120	149	YT-41961	153	YT-4403	158	YT-44675	151	YT-4520	134; 393	YT-47141	136	YT-51320	105; 395		
YT-36503	222	YT-3828	25	YT-4140	149	YT-41962	153	YT-44100	157	YT-44676	151	YT-4521	134; 393	YT-47142	136	YT-5140	105; 395		
YT-36504	222	YT-3829	25	YT-4160	149	YT-41963	153	YT-44104	157	YT-44700	151	YT-4522	134; 393	YT-47143	136	YT-5141	105; 395		
YT-36505	222	YT-3830	25	YT-41602	150	YT-41964	153	YT-44105	157	YT-44705	151	YT-4550	132	YT-47144	136	YT-5142	105; 395		
YT-36510	223	YT-3831	25	YT-41603	150	YT-41965	153	YT-44106	157	YT-44710	161	YT-4551	132	YT-47145	136	YT-51450	222; 242		
YT-36511	223	YT-3832	25	YT-41604	150	YT-41966	153	YT-44111	157	YT-44730	161	YT-4552	132	YT-47146	136	YT-51451	221; 242		
YT-36512	223	YT-3833	25	YT-41605	150	YT-41967	153	YT-44112	157	YT-44740	161	YT-4553	132	YT-47147	136	YT-51452	221; 242		
YT-36700	210; 228; 427	YT-3839	27	YT-4161	152	YT-41968	153	YT-44113	157	YT-44741	161	YT-4560	133	YT-47148	136	YT-51900	238		
		YT-3840	26	YT-4162	152	YT-41969	153	YT-44120	157	YT-44750	150	YT-4561	133	YT-47149	136	YT-51901	238		
YT-36704	210; 228; 428	YT-3841	27	YT-4163	152	YT-41970	153	YT-4430	149	YT-44751	150	YT-4562	133	YT-47150	136	YT-51902	238		
		YT-3842	25	YT-4164	152	YT-41971	153	YT-4431	149	YT-44752	150	YT-4563	133	YT-47151	136	YT-51903	238		
YT-36706	210; 228; 427	YT-3843	25	YT-41641	152	YT-41972	153	YT-4432	149	YT-44754	150	YT-4564	133	YT-47152	136	YT-51904	239		
		YT-3844	25	YT-41642	152	YT-41973	153	YT-4433	149	YT-44755	150	YT-4570	133	YT-47160	188	YT-51905	239		
YT-36709	211; 229; 428	YT-3845	25	YT-4165	152	YT-41974	153	YT-4434	149	YT-44756	150	YT-4571	133	YT-47161	188	YT-51906	239		
		YT-3847	26	YT-4166	152	YT-4200	152	YT-4435	149	YT-44757	150	YT-4573	133	YT-47195	158	YT-51907	239		
YT-36710	210; 228; 428	YT-3848	26	YT-4167	152	YT-4201	152	YT-4436	149	YT-44758	150	YT-4590	134; 393	YT-4720	158	YT-51908	239		
		YT-3849	26	YT-4168	152	YT-4202	152	YT-4437	149	YT-44759	150	YT-4594	134	YT-47200	158	YT-51909	238		
YT-36715	211; 229; 428	YT-3850	26	YT-4169	152	YT-4203	152	YT-4438	149	YT-44760	150	YT-4600	134	YT-4721	158	YT-51910	239		
		YT-3851	27; 348	YT-4170	152	YT-4204	152	YT-4439	149	YT-44761	150	YT-4601	134	YT-47212	158	YT-51911	239		
YT-3701	234	YT-38510	27; 348	YT-4171	152	YT-4205	152	YT-4440	149	YT-44763	150	YT-4602	134	YT-4722	158	YT-51920	239		
YT-3703	234	YT-38511	27; 348	YT-4172	152	YT-4206	152	YT-4441	149	YT-44764	150	YT-4603	134	YT-4723	158	YT-5200	237		
YT-37034	235	YT-38512	27; 348	YT-4173	152	YT-4207	152	YT-4442	149	YT-44765	150	YT-4604	1						

YATO	page/strona	YATO	page/strona	YATO	page/strona	YATO	page/strona	YATO	page/strona	YATO	page/strona	YATO	page/strona	YATO	page/strona		
YT-72301	260	YT-74003	446	YT-7511	187	YT-77908	81	YT-80156	464	YT-8033	463	YT-80554	458	YT-80854	459	YT-8120	250; 482
YT-72302	260	YT-74060	454	YT-7512	187	YT-77920	81	YT-80157	464	YT-8034	463	YT-80555	458	YT-80855	459	YT-81490	376
YT-72303	260	YT-74070	446	YT-75121	187	YT-77921	81	YT-80158	461	YT-80355	460	YT-80556	458	YT-80856	459	YT-81491	376
YT-72305	260	YT-74071	446	YT-75122	187	YT-77922	81	YT-80159	461	YT-80356	460	YT-80557	458	YT-80857	459	YT-8152	126
YT-72981	349	YT-7409	447	YT-75140	188	YT-77923	81	YT-80160	461	YT-80357	460	YT-80558	458	YT-80858	459	YT-8156	126
YT-7300	344	YT-7410	447	YT-7520	186	YT-77924	81	YT-80161	461	YT-80358	460	YT-80559	458	YT-80859	459	YT-8159	126
YT-7301	344	YT-7413	447	YT-75201	186	YT-7807	82	YT-80162	461	YT-80359	460	YT-80560	458	YT-80860	459	YT-81591	126
YT-7302	344	YT-7414	447	YT-7524	187	YT-7808	82	YT-80163	461	YT-80360	460	YT-80572	458	YT-80900	462	YT-81592	126
YT-73030	343	YT-74141	447	YT-7525	187	YT-7809	82	YT-80164	463	YT-80361	460	YT-80573	458	YT-80901	462	YT-81593	126
YT-7306	344	YT-7416	448	YT-7527	187	YT-7810	82	YT-80165	463	YT-80362	460	YT-80574	458	YT-80902	462	YT-81594	126
YT-7307	343	YT-7417	448	YT-7528	187	YT-7811	82	YT-80166	463	YT-80363	460	YT-80575	458	YT-80903	462	YT-81595	126
YT-73080	123; 256	YT-74171	447	YT-7529	187	YT-7812	82	YT-80167	463	YT-80364	460	YT-80576	458	YT-80904	462	YT-8165	126
YT-73081	123; 256	YT-74172	448	YT-7530	187	YT-78130	80	YT-80168	463	YT-80365	460	YT-80577	458	YT-80905	462	YT-81651	126
YT-73083	123; 256	YT-7419	448	YT-7531	187	YT-78131	80	YT-80169	463	YT-80366	460	YT-80578	458	YT-80906	463	YT-81652	126
YT-73084	123; 257	YT-7420	448	YT-7532	186	YT-78132	80	YT-80170	464	YT-80367	460	YT-80579	458	YT-80907	463	YT-81654	126
YT-73085	124; 257	YT-74220	455	YT-7534	186	YT-78133	80	YT-80171	464	YT-80368	460	YT-80580	458	YT-80908	463	YT-81655	126
YT-73086	124; 257	YT-74221	455	YT-7550	192	YT-78134	80	YT-80172	464	YT-80380	461	YT-80583	458	YT-80909	463	YT-8166	126
YT-73087	124; 257	YT-74227	455	YT-7551	192	YT-78135	80	YT-80173	464	YT-80381	461	YT-80584	458	YT-80910	463	YT-8173	126
YT-73090	124; 257	YT-74229	455	YT-7560	188	YT-78136	80	YT-80174	464	YT-80382	461	YT-80585	458	YT-80911	463	YT-8174	126
YT-73091	124; 257	YT-74240	454	YT-7561	188	YT-78141	80	YT-80175	464	YT-80383	461	YT-80586	458	YT-80912	465	YT-8177	126
YT-7310	346	YT-742401	454	YT-7581	187	YT-78142	80	YT-80176	461	YT-80384	461	YT-80587	458	YT-80913	465	YT-81775	471
YT-7311	346	YT-74241	454	YT-75811	187	YT-78143	80	YT-80177	461	YT-80390	460	YT-80588	458	YT-80914	465	YT-81788	473
YT-7312	346	YT-742411	454	YT-7600	121; 185	YT-78144	80	YT-80178	461	YT-80391	460	YT-80589	458	YT-80915	465	YT-81789	473
YT-73126	261	YT-74242	454	YT-7601	121; 185	YT-78145	80	YT-80179	461	YT-80392	460	YT-80590	458	YT-80916	465	YT-81797	471
YT-73127	261	YT-742421	454	YT-76031	185	YT-78146	80	YT-80180	461	YT-80393	460	YT-80591	458	YT-80917	465	YT-81798	472
YT-73131	123; 261	YT-7430	448	YT-76040	185	YT-78147	80	YT-80181	461	YT-80394	460	YT-80733	459	YT-80918	465	YT-81799	473
YT-73140	257	YT-7433	448	YT-76041	185	YT-7815	82	YT-80182	463	YT-80395	461	YT-80734	459	YT-80919	465	YT-81800	471
YT-73141	257	YT-7435	449	YT-76042	186	YT-78150	80	YT-80183	463	YT-80396	461	YT-80735	459	YT-80920	465	YT-81801	472
YT-7320	330	YT-74351	448	YT-76043	186	YT-78151	80	YT-80184	463	YT-80397	461	YT-80736	459	YT-80921	465	YT-81802	473
YT-7349	369	YT-74360	448	YT-76050	185	YT-78152	80	YT-80185	463	YT-80398	461	YT-80737	459	YT-80922	465	YT-81803	472
YT-7350	369	YT-74361	448	YT-76051	185	YT-78153	80	YT-80186	463	YT-80399	461	YT-80738	459	YT-80923	465	YT-81804	472
YT-73521	369	YT-74370	449	YT-76052	185	YT-78154	80	YT-80187	463	YT-80400	461	YT-80739	459	YT-80924	462	YT-81806	472
YT-73530	369	YT-74371	449	YT-76060	186	YT-78155	80	YT-80188	464	YT-80401	463	YT-80740	459	YT-80925	462	YT-81807	472
YT-7360	452	YT-74372	449	YT-76080	196	YT-78156	80	YT-80189	464	YT-80402	463	YT-80741	459	YT-80926	462	YT-81810	473
YT-73602	452	YT-74373	449	YT-76085	196	YT-78160	80	YT-80190	464	YT-80403	463	YT-80761	459	YT-80927	462	YT-81812	360; 474
YT-73603	453	YT-7446	449	YT-76086	196	YT-78161	80	YT-80191	464	YT-80404	463	YT-80762	459	YT-80928	462	YT-81820	360; 474
YT-7361	452	YT-7451	457	YT-76087	196	YT-78162	80	YT-80192	464	YT-80405	463	YT-80763	459	YT-80929	462	YT-81821	360; 474
YT-73611	453	YT-74510	457	YT-7620	248	YT-78163	80	YT-80193	464	YT-80406	463	YT-80764	459	YT-80930	462	YT-81834	470
YT-73612	453	YT-7455	457	YT-7623	249	YT-78164	80	YT-80194	465	YT-80407	465	YT-80765	459	YT-80931	462	YT-81835	470
YT-73613	453	YT-7456	457	YT-7624	249	YT-78165	80	YT-80195	465	YT-80408	465	YT-80766	459	YT-80932	462	YT-81840	469
YT-73614	453	YT-7458	457	YT-76260	242	YT-78166	80	YT-80196	465	YT-80409	465	YT-80767	459	YT-80933	462	YT-81841	469
YT-73615	453	YT-7460	455	YT-76266	242	YT-78167	80	YT-80197	465	YT-80410	465	YT-80768	459	YT-80934	462	YT-81842	469
YT-7362	452	YT-7461	455	YT-7751	54	YT-7848	82	YT-80198	465	YT-80411	465	YT-80769	459	YT-80935	462	YT-81843	469
YT-7363	452	YT-7462	457	YT-7752	54	YT-7881	82	YT-80199	465	YT-80412	465	YT-80783	459	YT-80936	462	YT-81844	470
YT-73631	452	YT-74621	457	YT-7753	54	YT-7882	82	YT-8020	461	YT-80435	460	YT-80784	459	YT-80937	462	YT-81845	470
YT-7364	452	YT-7463	457	YT-77870	81	YT-7883	82	YT-8021	461	YT-80436	460	YT-80785	459	YT-80938	462	YT-81846	470
YT-73641	452	YT-7470	454	YT-77871	81	YT-7980	82	YT-8022	461	YT-80437	460	YT-80786	459	YT-80939	462	YT-81847	470
YT-7365	452	YT-7471	454	YT-77872	81	YT-8001	139; 498	YT-8023	461	YT-80438	460	YT-80787	459	YT-80940	462	YT-81848	470
YT-7366	452	YT-7472	454	YT-77873	81	YT-8002	139; 498	YT-8024	461	YT-80439	460	YT-80788	459	YT-80941	462	YT-81849	470
YT-7367	452	YT-7473	454	YT-77875	81	YT-8003	139; 498	YT-8025	462	YT-80460	458	YT-80789	459	YT-80942	462	YT-81855	474
YT-7368	452	YT-7474	454	YT-77876	81	YT-8004	139; 498	YT-8026	462	YT-80461	458	YT-80790	459	YT-80943	462	YT-81856	475
YT-7369	452	YT-7480	454	YT-77877	81	YT-8005	139; 498	YT-8027	462	YT-80462	458	YT-80791	459	YT-80944	462	YT-81860	474
YT-73700	453	YT-7481	454	YT-77878	81	YT-8006	139; 498	YT-8028	462	YT-80463	458	YT-80794	459	YT-80945	462	YT-81880	475
YT-73701	453	YT-7485	456	YT-77879	81	YT-8011	139; 498	YT-80280	460	YT-80464	458	YT-80795	459	YT-80946	462	YT-81900	471
YT-7371	452	YT-74852	456	YT-77880	81	YT-8012	139; 498	YT-80281	460	YT-80465	458	YT-80796	459	YT-80947	462	YT-81901	471
YT-7374	452	YT-7486	456	YT-77881	81	YT-80130	139	YT-80282	460	YT-80466	458	YT-80797	459	YT-8100	250; 482	YT-81902	471
YT-7376	452	YT-74862	456	YT-77882	81	YT-80140	461	YT-80283	460	YT-80467	458	YT-80798	459	YT-8101	250; 482	YT-81903	471
YT-73760	452	YT-74870	456	YT-77883	81	YT-80141	461	YT-80284	460	YT-80468	458	YT-80799	459	YT-8102	250; 482	YT-81904	471
YT-73761	452	YT-7488	456	YT-77884	81	YT-80142	461	YT-80285	462	YT-80469	458	YT-80800	459	YT-81021	250; 482	YT-81941	468
YT-73765	453	YT-74916	456	YT-77885	81	YT-80143	461	YT-80286	462	YT-80470	458	YT-80801	459	YT-81022	250; 482	YT-81943	468
YT-73766	453	YT-74917	456	YT-77891	81	YT-80144	461	YT-80287	462	YT-80471	458	YT-80802	459	YT-81023	250; 482	YT-81947	468
YT-7377	453	YT-74919	457	YT-77892	81	YT-80145	461	YT-80288	462	YT-80521	458	YT-80841	459	YT-81024	250; 482	YT-81948	468
YT-7380	453	YT-7492	456	YT-77893	81	YT-80146	463	YT-80289	462	YT-80522	458	YT-80842	459	YT-81052	250; 482	YT-81951	468
YT-73801	453	YT-74949	457	YT-77894	81	YT-80147	463	YT-8029	462	YT-80523	458	YT-80843	459	YT-81053	250; 482	YT-81952	468
YT-7381	453	YT-75001	187	YT-77900	81	YT-80148	463	YT-80290	464	YT-80524	458	YT-80844	459	YT-81054	250; 482	YT-81960	469
YT-7382	453	YT-7504	187	YT-7790													

YATO	page/strona	YATO	page/strona	YATO	page/strona	YATO	page/strona	YATO	page/strona	YATO	page/strona	YATO	page/strona		
YT-82036	418			YT-82901	405	YT-83229	199	YT-83441	200	YT-8410	198	YT-84971	442; 512	YT-8845	494
YT-82037	419	YT-82455	125; 230; 429	YT-82902	405	YT-83230	199	YT-83442	200	YT-8411	198	YT-84975	442; 512	YT-8849	494
YT-82044	419	YT-82550	424	YT-82903	405	YT-83231	199	YT-83443	200	YT-8412	198	YT-84976	442; 512	YT-8851	497
YT-82050	419	YT-82560	424	YT-82904	405	YT-83232	199	YT-83444	200	YT-8413	198	YT-84977	442; 512	YT-8852	497
YT-82051	419	YT-82600	421	YT-82909	405	YT-83233	199	YT-83445	200	YT-8414	198	YT-84978	442; 512	YT-8853	497
YT-82070	419	YT-82601	421	YT-82952	392	YT-83234	199	YT-83446	200	YT-8415	198	YT-85000	436; 506	YT-8854	497
YT-82091	416			YT-82953	392	YT-83235	199	YT-83447	200	YT-8416	198	YT-85001	436; 506	YT-8865	499
YT-82094	417	YT-8271	125; 229; 428	YT-8300	374	YT-83236	199	YT-83448	200	YT-8417	198	YT-85003	436; 506	YT-8866	499
YT-82097	416			YT-8301	374	YT-83237	199	YT-83451	200	YT-8418	198	YT-85021	436; 506	YT-8867	499
YT-82100	417			YT-8302	374	YT-83238	199	YT-83452	200	YT-8440	197	YT-85080	431; 501	YT-8868	499
YT-82101	417			YT-8303	374	YT-83239	199	YT-83453	200	YT-8441	197	YT-85090	431; 501	YT-8869	499
YT-82103	417	YT-8273	125; 229; 428	YT-83031	374	YT-83240	199	YT-83454	200	YT-8442	197	YT-85100	433; 503	YT-8870	499
YT-82110	417	YT-82742	126; 229	YT-83032	374	YT-83271	199	YT-83455	200	YT-8443	197	YT-85110	432; 502	YT-8876	496
YT-82115	420	YT-82743	126; 229	YT-83033	374	YT-83272	199	YT-83456	200	YT-8444	197	YT-85120	432; 501	YT-8885	499
YT-82120	420	YT-82744	126; 229	YT-8304	375	YT-83273	199	YT-83457	200	YT-8445	197	YT-85130	434; 504	YT-8886	499
YT-82122	420	YT-82760	410	YT-8305	375	YT-83274	199	YT-83458	200	YT-8446	197	YT-85131	434; 504	YT-8889	499
YT-82123	420	YT-82770	414	YT-83051	375	YT-83275	199	YT-83480	201	YT-8447	197	YT-85132	431; 501	YT-8890	499
YT-82125	420	YT-82780	406	YT-83052	375	YT-83276	199	YT-83481	201	YT-8448	197	YT-85133	431; 501	YT-8891	499
YT-82127	420	YT-82781	406	YT-83060	375	YT-83291	199	YT-83482	201	YT-8449	197	YT-85140	435; 505	YT-8892	499
YT-82130	421	YT-82782	406	YT-83061	375	YT-83292	199	YT-83483	201	YT-8450	197	YT-85170	427	YT-8894	500
YT-82133	421	YT-82783	407	YT-83062	375	YT-83293	199	YT-83484	201	YT-8451	197	YT-85200	435; 504	YT-8950	488
YT-82135	421	YT-82784	406	YT-83080	375	YT-83294	199	YT-83485	201	YT-8452	197	YT-85205	435; 504	YT-8955	488
YT-82140	423	YT-82786	407	YT-83081	375	YT-83295	199	YT-83486	201	YT-8453	197	YT-85208	435; 505	YT-8956	488
YT-82141	422	YT-82787	407	YT-8310	256; 376	YT-83296	199	YT-83487	201	YT-8454	197	YT-85350	431; 492	YT-8957	489
YT-82150	422	YT-82788	407	YT-83101	256; 376	YT-83351	199	YT-83488	201	YT-8455	197	YT-85401	430	YT-8958	489
YT-82153	422	YT-82789	408	YT-8311	256; 376	YT-83352	199	YT-83490	201	YT-8456	197	YT-85402	430	YT-8959	489
YT-82171	422	YT-82794	408	YT-83140	128; 387	YT-83353	199	YT-83491	201	YT-8457	197	YT-85403	430	YT-8960	490
YT-82181	418	YT-82795	408	YT-83141	128; 387	YT-83354	199	YT-83492	201	YT-84820	416	YT-85451	430	YT-8963	489
YT-82185	418	YT-82796	408	YT-83142	128; 387	YT-83355	199	YT-83493	201	YT-8483	197	YT-85453	430	YT-8964	489
YT-82190	249; 426	YT-82797	409	YT-83143	128; 387	YT-83356	199	YT-83494	201	YT-8484	197	YT-85460	430	YT-8965	488
YT-82195	418	YT-82800	409	YT-83151	376	YT-83361	199	YT-83495	201	YT-8485	197	YT-85481	430	YT-8966	488
YT-82200	417	YT-82801	409	YT-83152	376	YT-83362	199	YT-83496	201	YT-8486	197	YT-85482	430	YT-8967	489
YT-82220	424	YT-82804	409	YT-83153	376	YT-83363	199	YT-83497	201	YT-84895	435; 505	YT-85700	425	YT-8968	490
YT-82223	425	YT-82805	410	YT-83160	198	YT-83364	199	YT-83498	201	YT-84901	435; 505	YT-85701	425	YT-8970	486
YT-82230	423	YT-82810	410	YT-83161	198	YT-83365	199	YT-8350	197	YT-84910	436; 506	YT-85710	426	YT-8971	486
YT-82250	211; 429	YT-82811	410	YT-83162	198	YT-83366	199	YT-8351	197	YT-84925	437; 507	YT-85715	426	YT-8972	486
YT-82270	422	YT-82814	411	YT-83163	198	YT-83371	199	YT-8352	197	YT-84927	437; 507	YT-86800	500	YT-8973	487
YT-82272	422	YT-82815	411	YT-83164	198	YT-83372	199	YT-8353	197	YT-84928	437; 507	YT-86801	500	YT-8974	487
YT-82280	423	YT-82818	412	YT-83165	198	YT-83373	199	YT-8354	197	YT-84930	437; 507	YT-86804	500	YT-8975	487
YT-82288	426	YT-82819	412	YT-83166	198	YT-83374	199	YT-8355	197	YT-84931	437; 507	YT-86805	500	YT-8976	487
YT-82291	426	YT-82822	413	YT-83167	198	YT-83375	199	YT-8356	197	YT-849311	437; 507	YT-86808	500	YT-8977	487
YT-82292	427	YT-82823	413	YT-83168	198	YT-83376	199	YT-8357	197	YT-84932	438; 508	YT-86809	500	YT-8978	487
YT-82293	427	YT-82826	413	YT-83169	198	YT-83381	199	YT-8358	197	YT-849321	438; 508	YT-8790	494	YT-8979	486
YT-82340	423	YT-82827	413	YT-83181	198	YT-83382	199	YT-8360	197	YT-84933	438; 508	YT-8791	494	YT-8984	491
YT-82341	423	YT-82828	413	YT-83182	198	YT-83383	199	YT-8361	197	YT-84934	438; 508	YT-8800	493	YT-8985	491
YT-82350	423			YT-83183	198	YT-83384	199	YT-8362	197	YT-84935	438; 508	YT-8801	493	YT-8986	491
YT-82401	125; 230; 429	YT-82830	414; 433; 502	YT-83184	198	YT-83385	199	YT-8363	197	YT-849351	438; 508	YT-8802	493	YT-8987	491
		YT-82831	414; 433; 502	YT-83185	198	YT-83386	199	YT-8364	197	YT-849355	439; 509	YT-8805	493	YT-8991	491
YT-82402	125; 230; 429			YT-83186	198	YT-83390	200	YT-8365	197	YT-84936	439; 509	YT-8807	493	YT-8993	491
		YT-82832	414; 433; 503	YT-83187	198	YT-83391	200	YT-8366	197	YT-84937	439; 509	YT-8808	493	YT-9940	487
YT-82430	230			YT-83188	198	YT-83392	200	YT-8367	197	YT-849395	439; 509	YT-8809	493	YT-9941	487
YT-82431	230			YT-83190	198	YT-83393	200	YT-8368	197	YT-84940	439; 509	YT-8811	493	YT-99801	486
YT-82433	231	YT-82833	414; 433; 503	YT-83200	198	YT-83394	200	YT-8370	197	YT-84941	439; 509	YT-8815	494	YT-99802	486
YT-82434	231			YT-83202	198	YT-83395	200	YT-8371	197	YT-84942	439; 509	YT-8816	494	YT-99803	486
YT-82435	231	YT-82834	415; 434; 503	YT-83203	198	YT-83396	200	YT-8372	197	YT-84943	440; 510	YT-8817	494	YT-99804	486
YT-82436	231			YT-83204	198	YT-83397	200	YT-8373	197	YT-84944	440; 510	YT-8821	497	YT-99810	486
YT-82437	231	YT-82835	415; 434; 503	YT-83205	198	YT-83398	200	YT-8374	197	YT-84945	440; 510	YT-8822	497	YT-99811	486
YT-82438	231			YT-83206	198	YT-83399	200	YT-8375	197	YT-84948	440; 510	YT-8823	497	YT-99812	486
YT-82439	231	YT-82836	415; 432; 501	YT-83207	198	YT-83400	200	YT-8376	197	YT-84949	440; 510	YT-8824	497	YT-99813	486
YT-82440	231			YT-83208	198	YT-83401	200	YT-8377	197	YT-84950	440; 510	YT-8831	495	YT-99814	487
YT-82441	231	YT-82837	415; 432; 502	YT-83209	198	YT-83420	200	YT-8378	197	YT-84951	440; 510	YT-8832	495	YT-99815	487
YT-82442	231			YT-83210	198	YT-83430	200	YT-8400	198	YT-84952	440; 510	YT-8833	495	YT-99830	488
YT-82443	231	YT-82842	415; 434; 504	YT-83211	198	YT-83431	200	YT-8401	198	YT-84953	441; 511	YT-8834	495	YT-99831	490
YT-82444	231			YT-83220	199	YT-83432	200	YT-8402	198	YT-84954	441; 511	YT-8835	495	YT-99832	490
YT-82445	231	YT-82843	415; 434; 504	YT-83221	199	YT-83433	200	YT-8403	198	YT-84955	441; 511	YT-8836	495	YT-99841	490
YT-82446	231			YT-83222	199	YT-83434	200	YT-8404	198	YT-84956	441; 511	YT-8838	495	YT-99845	492
YT-82447	231	YT-82844	415; 434; 504	YT-83223	199	YT-83435	200	YT-8405	198	YT-84960	441; 511	YT-8839	496	YT-99848	487
				YT-83224	199	YT-83436	200	YT-8406	198	YT-84961	441; 511	YT-8840	496	YT-99850	492
YT-8245	125; 229; 429	YT-82848	415; 434; 504	YT-83225	199	YT-83437	200	YT-8407	198	YT-84962	441; 511	YT-8841	496	YT-99852	492
				YT-83227	199	YT-83438	200	YT-8408	198	YT-84963	441; 511	YT-8842	496	YT-99853	492
YT-82451	125; 230; 429	YT-82900	411; 424	YT-83228	199	YT-83440	200	YT-8409	198	YT-84970	442; 512	YT-8843	494		



MANUFACTURER / PRODUCENT

TOYA S.A.
ul. Soltysowicka 13-15
51-168 Wrocław
Poland
☎ (+48 71) 32 46 200
fax: (+48 71) 32 46 370
sales@yato.pl (domestic)
export@yato.pl (export)
import@yato.pl (import)

ODDZIAŁ WARSZAWSKI
Teren ProLogis Park Nadarzyn
al. Kasztanowa 160
05-831 Młochów k. Warszawy
Poland
☎ (+48 22) 73 82 800
☎ (+48 22) 73 82 828
sales@yato.pl (domestic)
export@yato.pl (export)

TOYA ROMANIA S.A.
Sos. Odăi Nr. 109-123
Sector 1, București
☎ (+40 031) 710 8692
office@yato.ro

YATO TOOLS (Shanghai) Co., Ltd.
No. 8, Lane 1300, East Kangqiao Road
Shanghai, China 201315
☎ (+86 21) 681 829 50
fax: (+86 21) 681 829 51
yato@yato-sh.com

YOUR TRUSTED SUPPLIER: / TWÓJ ZAUFANY DOSTAWCA:



www.yato.com

**GET ACQUAINTED WITH OUR WIDE OFFER:
ZOBACZ NASZĄ BOGATĄ OFERTĘ:**

