



Addressable SK6812 RGBW/WWLED Strip-60leds



Product Description

Addressable RGBW LED Strip with 60LEDs/m

60Pixels per meter, cut-able every 16.67mm

The PCB is 1+2 Ounce copper, 10mm width

White and Black PCB are available, DC5V voltage,

SPI signal 5 Meters per reel,



Customized sizes are also available

3Pin JST SM connector, IP65 waterproof by silicon tube housing

The color(CCT) of White can be warm white, pure white and cold white



Product Datasheet

Product Number	S010060CA4SA1
Light Source	SMD 5050 4 in1 RGBW
Beam Angle	120°
LED Quantity	60 leds/m
CCT	RGBW 2800-3200 K 4000-4500 K 6000-6500 K 9000-13000K
Wavelength (nm/m)	R:620-630 G:515-525 B:460-470
Protocol	SK6812
Operating Voltage	DC5V
Power (W)	14W/M (Max)
Size (mm)	L 5000* W 10
IP	IP 20/IP 65
Net Weight	0.13kg/roll
Operation Temperature	- 40 ~ 50 °C

Application



Hotels ,restaurants, nights clubs, edge light

Recreational machines, playstation



Living rooms, coffee / wine bars, back lighting

TV, dancefloor background, shopping malls,

Strip IP Rate





Curve Lune

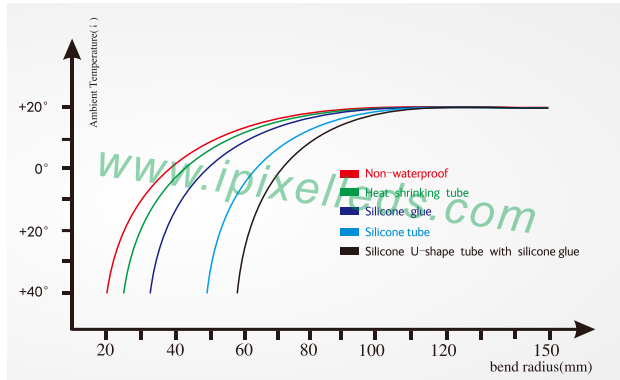
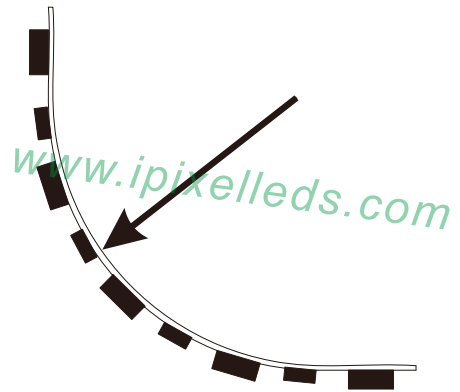
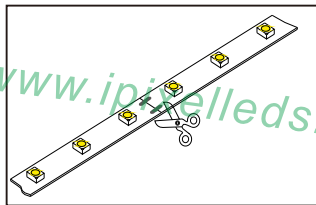

Diagram2: Bend Curve



Installation



Cut in specific location

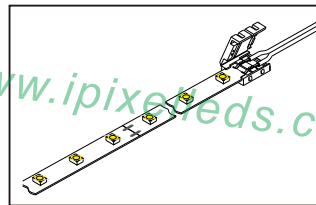

Put the PCB in the space between clip and connector, make the clips exactly aim at welding point

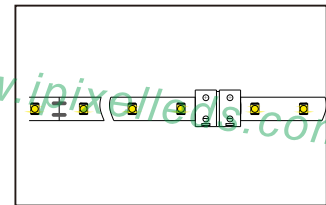

Close the cover of connector

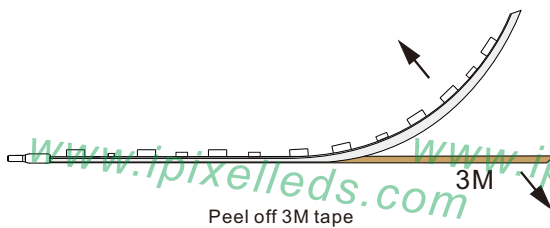

Peel off 3M tape

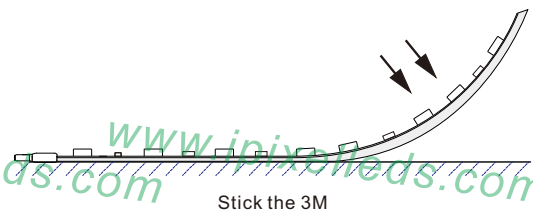

Stick the 3M



Install with clips

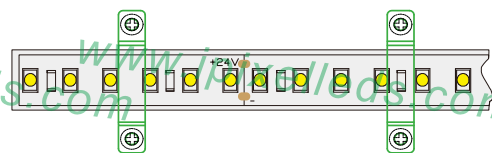

Fix with screws

Accessories (Excluded)



Screws



Silicone clip



End cap



iPixel LED Light Co., Ltd

Outline Dimension (unit:mm)

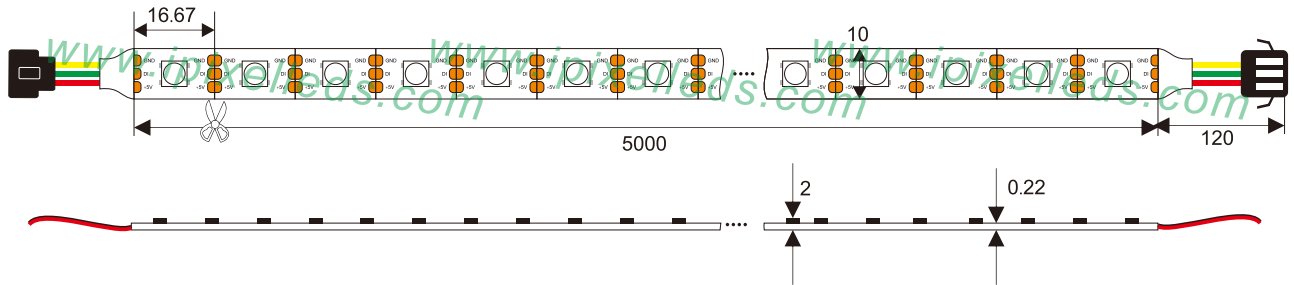

Connection

RGB LED strip light

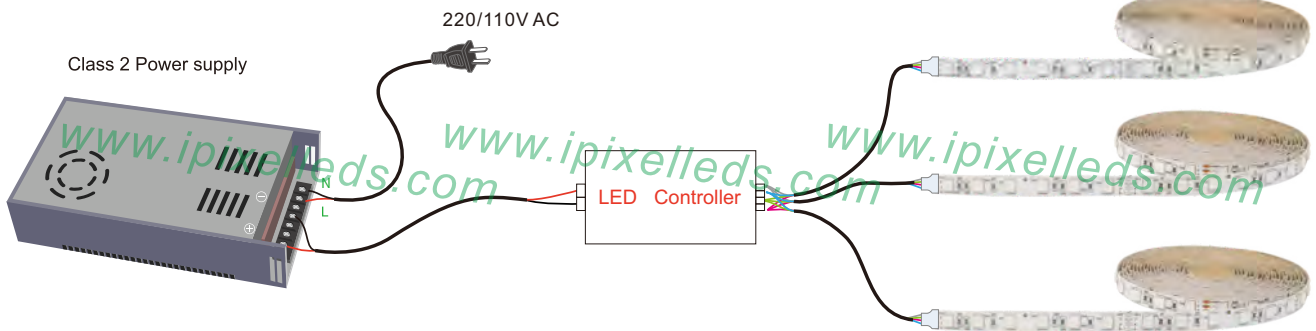

NOTES

1. Please apply different IP rate products according to different environment conditions;
2. Only install with Class 2 power unit
3. Do not install it when power is on. Before powering on, please make sure the wiring is correct;
4. Avoiding damaging the circuit or other component on the strip;
5. Avoid dragging, do not over bending during installation;
6. In order to get the best lighting effect, please do not connect overlong;
7. Please do not stare at the light for along time when it is working to protect your eyes;
8. Installation required by a qualified electrician
9. Supply cable – R/C (AVLV2/8), external use style, rated minimum 300 V, 80 °C, minimum 22 AWG

Product packaging

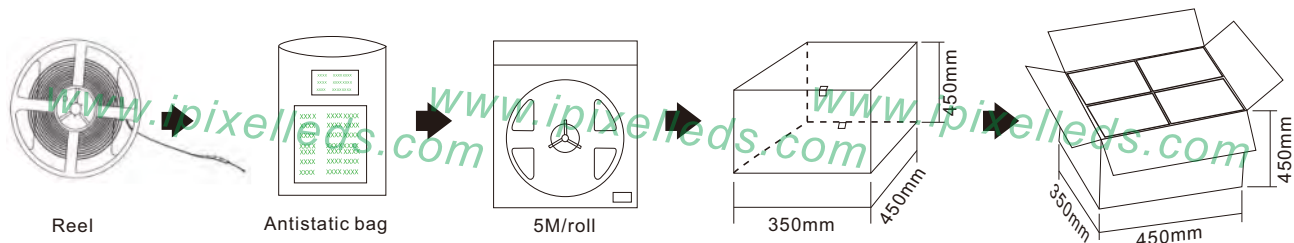

Product number	Standard length	Quantity / volume	outer carton size	Weight(kg)/reel
S010060CA4SA1(IP20)	5M	240 Reels	L450xW350xH450mm	0.13kg
/				/
/				/
/				/
/				/