

**PowerMOS transistor**

**BUK455-600B**

**GENERAL DESCRIPTION**

N-channel enhancement mode field-effect power transistor in a plastic envelope.  
The device is intended for use in Switched Mode Power Supplies (SMPS), motor control, welding, DC/DC and AC/DC converters, and in general purpose switching applications.

**QUICK REFERENCE DATA**

SYMBOL	PARAMETER	MAX.	UNIT
$V_{DS}$	Drain-source voltage	600	V
$I_D$	Drain current (DC)	4.0	A
$P_{tot}$	Total power dissipation	100	W
$R_{DS(ON)}$	Drain-source on-state resistance	2.5	$\Omega$

**PINNING - TO220AB**

PIN	DESCRIPTION
1	gate
2	drain
3	source
tab	drain

**PIN CONFIGURATION**

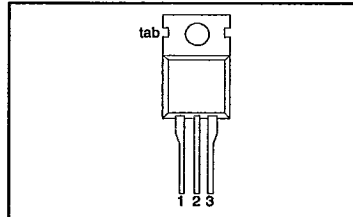

**SYMBOL**

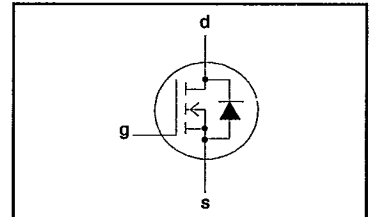

**LIMITING VALUES**

Limiting values in accordance with the Absolute Maximum System (IEC 134)

SYMBOL	PARAMETER	CONDITIONS	MIN.	MAX.	UNIT
$V_{DS}$	Drain-source voltage	-	-	600	V
$V_{DGR}$	Drain-gate voltage	$R_{GS} = 20 \text{ k}\Omega$	-	600	V
$\pm V_{GS}$	Gate-source voltage	-	-	30	V
$I_D$	Drain current (DC)	$T_{mb} = 25 \text{ }^\circ\text{C}$	-	4.0	A
$I_D$	Drain current (DC)	$T_{mb} = 100 \text{ }^\circ\text{C}$	-	2.5	A
$I_{DM}$	Drain current (pulse peak value)	$T_{mb} = 25 \text{ }^\circ\text{C}$	-	16	A
$P_{tot}$	Total power dissipation	$T_{mb} = 25 \text{ }^\circ\text{C}$	-	100	W
$T_{stg}$	Storage temperature	-	-55	150	$^\circ\text{C}$
$T_j$	Junction Temperature	-	-	150	$^\circ\text{C}$

**THERMAL RESISTANCES**

SYMBOL	PARAMETER	CONDITIONS	MIN.	TYP.	MAX.	UNIT
$R_{thj-mb}$	Thermal resistance junction to mounting base		-	-	1.25	K/W
$R_{thj-a}$	Thermal resistance junction to ambient		-	60	-	K/W

## PowerMOS transistor

BUK455-600B

## STATIC CHARACTERISTICS

 $T_{mb} = 25\text{ }^{\circ}\text{C}$  unless otherwise specified

SYMBOL	PARAMETER	CONDITIONS	MIN.	TYP.	MAX.	UNIT
$V_{(BR)DSS}$	Drain-source breakdown voltage	$V_{GS} = 0\text{ V}; I_D = 0.25\text{ mA}$	600	-	-	V
$V_{GS(TH)}$	Gate threshold voltage	$V_{DS} = V_{GS}; I_D = 1\text{ mA}$	2.1	3.0	4.0	V
$I_{DSS}$	Zero gate voltage drain current	$V_{DS} = 600\text{ V}; V_{GS} = 0\text{ V}; T_J = 25\text{ }^{\circ}\text{C}$	-	2	20	$\mu\text{A}$
$I_{DSS}$	Zero gate voltage drain current	$V_{DS} = 600\text{ V}; V_{GS} = 0\text{ V}; T_J = 125\text{ }^{\circ}\text{C}$	-	0.1	1.0	mA
$I_{GSS}$	Gate source leakage current	$V_{GS} = \pm 30\text{ V}; V_{DS} = 0\text{ V}$	-	10	100	nA
$R_{DS(ON)}$	Drain-source on-state resistance	$V_{GS} = 10\text{ V}; I_D = 2.5\text{ A}$	-	2.1	2.5	$\Omega$

## DYNAMIC CHARACTERISTICS

 $T_{mb} = 25\text{ }^{\circ}\text{C}$  unless otherwise specified

SYMBOL	PARAMETER	CONDITIONS	MIN.	TYP.	MAX.	UNIT
$g_{fs}$	Forward transconductance	$V_{DS} = 25\text{ V}; I_D = 2.5\text{ A}$	2.5	4.5	-	S
$C_{iss}$	Input capacitance	$V_{GS} = 0\text{ V}; V_{DS} = 25\text{ V}; f = 1\text{ MHz}$	-	750	1000	pF
$C_{oss}$	Output capacitance		-	90	140	pF
$C_{rss}$	Feedback capacitance		-	40	70	pF
$t_{d\text{ on}}$	Turn-on delay time	$V_{DD} = 30\text{ V}; I_D = 2.6\text{ A};$	-	10	45	ns
$t_r$	Turn-on rise time	$V_{GS} = 10\text{ V}; R_{GS} = 50\text{ }\Omega;$	-	45	60	ns
$t_{d\text{ off}}$	Turn-off delay time	$R_{gen} = 50\text{ }\Omega$	-	100	140	ns
$t_f$	Turn-off fall time		-	40	65	ns
$L_d$	Internal drain inductance	Measured from contact screw on tab to centre of die	-	3.5	-	nH
$L_d$	Internal drain inductance	Measured from drain lead 6 mm from package to centre of die	-	4.5	-	nH
$L_s$	Internal source inductance	Measured from source lead 6 mm from package to source bond pad	-	7.5	-	nH

## REVERSE DIODE LIMITING VALUES AND CHARACTERISTICS

 $T_{mb} = 25\text{ }^{\circ}\text{C}$  unless otherwise specified

SYMBOL	PARAMETER	CONDITIONS	MIN.	TYP.	MAX.	UNIT
$I_{DR}$	Continuous reverse drain current		-	-	4.5	A
$I_{DRM}$	Pulsed reverse drain current		-	-	18	A
$V_{SD}$	Diode forward voltage	$I_F = 4.5\text{ A}; V_{GS} = 0\text{ V}$	-	1.1	1.5	V
$t_r$	Reverse recovery time	$I_F = 4.5\text{ A}; -di_F/dt = 100\text{ A}/\mu\text{s};$	-	1200	-	ns
$Q_{rr}$	Reverse recovery charge	$V_{GS} = 0\text{ V}; V_R = 100\text{ V}$	-	6.0	-	$\mu\text{C}$

PowerMOS transistor

BUK455-600B

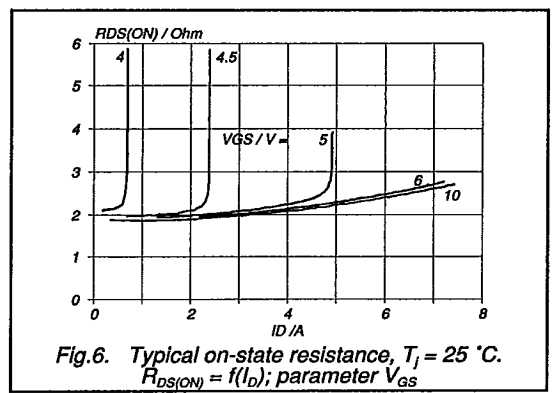
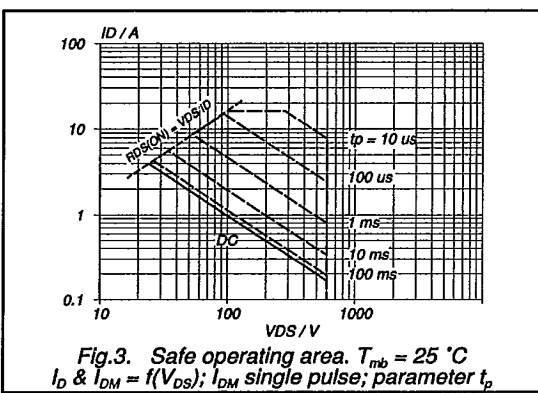
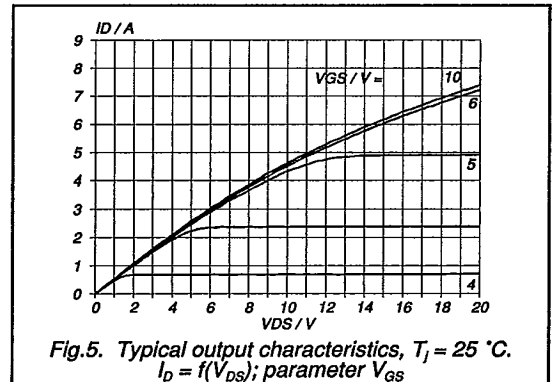
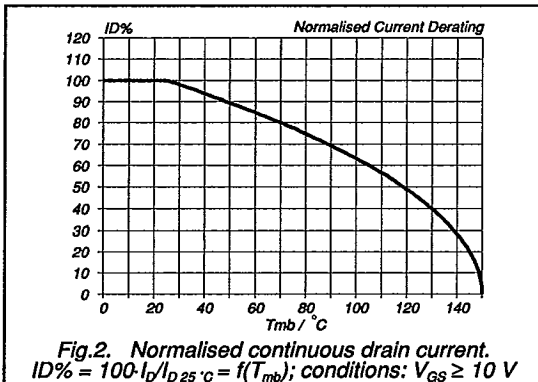
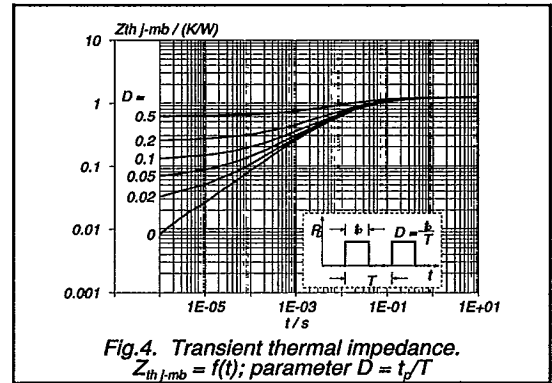
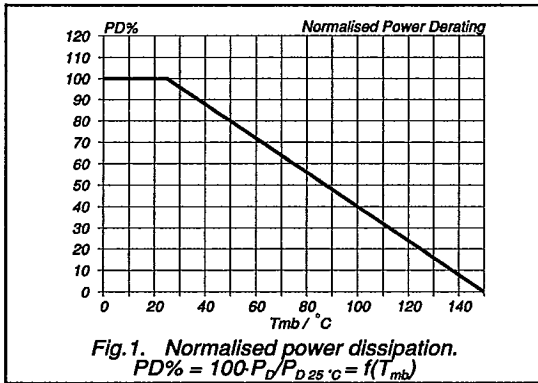

PowerMOS transistor

BUK455-600B

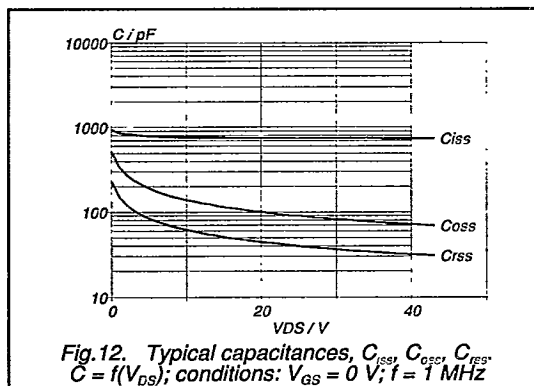
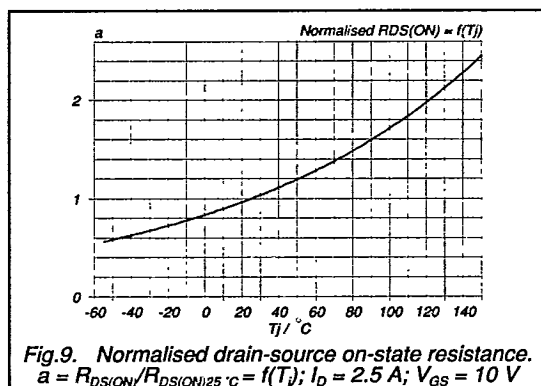
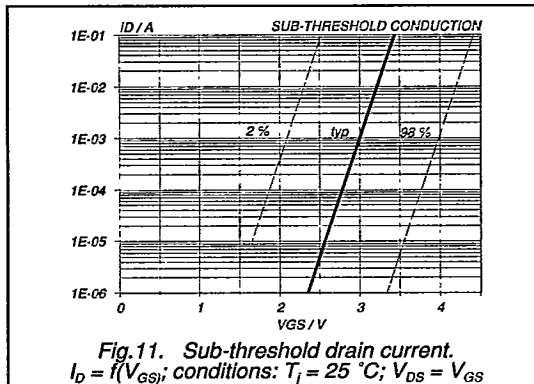
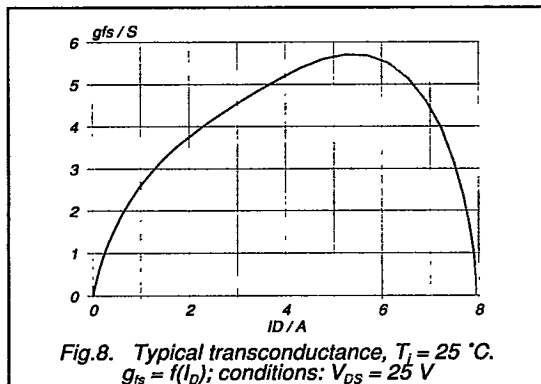
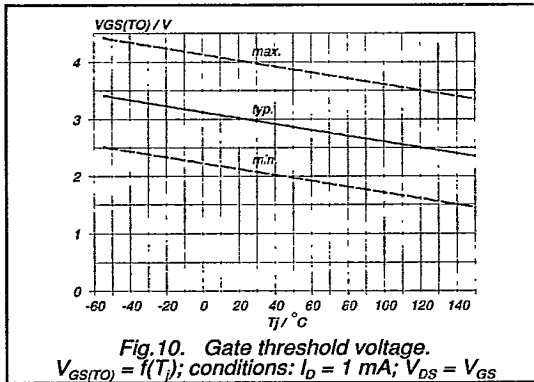
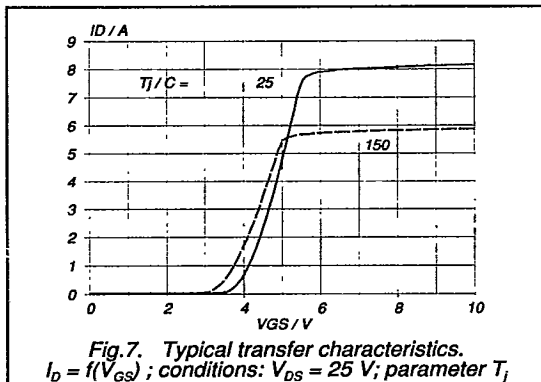

PowerMOS transistor

BUK455-600B

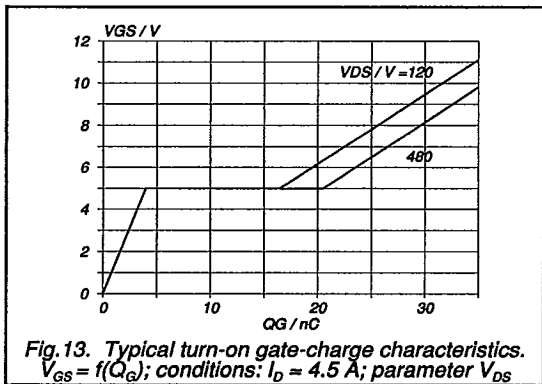

Fig.13. Typical turn-on gate-charge characteristics.  
 $V_{GS} = f(Q_G)$ ; conditions:  $I_D = 4.5$  A; parameter  $V_{DS}$

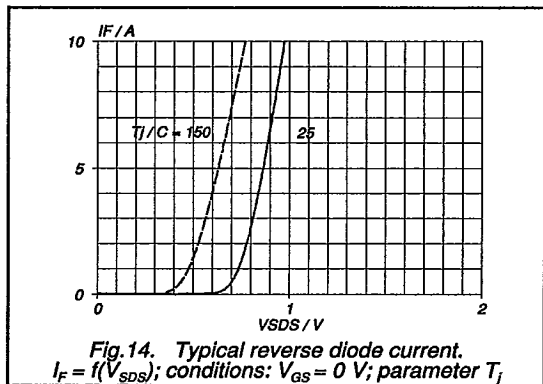

Fig.14. Typical reverse diode current.  
 $I_F = f(v_{SDS})$ ; conditions:  $V_{GS} = 0$  V; parameter  $T_j$