

VMA05

MANUAL HVMA05*1

IN/OUT shield for Arduino®

velleman®
MODULES

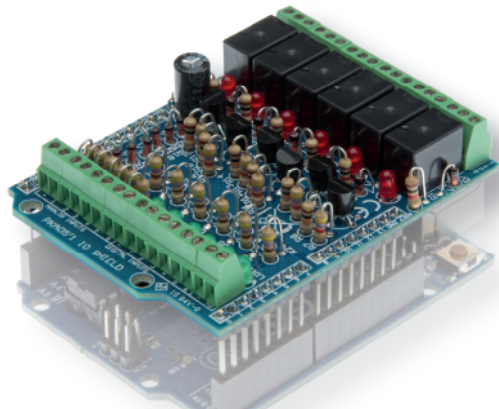

General purpose INPUT - OUTPUT shield for Arduino®

Features

- For use with Arduino Due, Arduino Uno, Arduino Mega
- 6 analog inputs
- 6 digital input
- 6 relay contact outputs: 0.5A max 30V (*)
- Indicator leds for relay outputs and digital inputs

Specifications

- Analog inputs: 0..+5VDC
- Digital inputs: dry contact or open collector
- Relays: 12V
- Relay contacts: NO/NC 24VDC/1A max.
- Dimensions: 68 x 53mm / 2.67 x 2.08"

(*) It is required to power the Arduino UNO (not supplied) with a 12V DC 500mA power supply (not supplied). This shield will not work with the Arduino Yún. Use the KA08 or VMA08 with the Arduino Yún.



1 OUTPUT MAX. 24VDC / 1A



Participate our Velleman Projects Forum

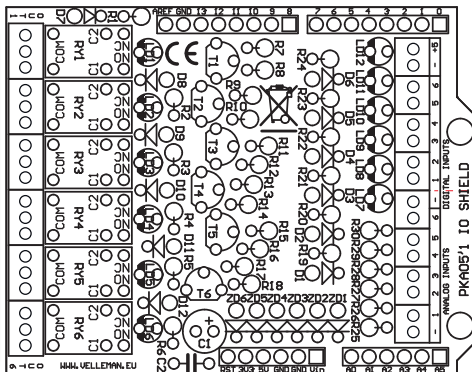
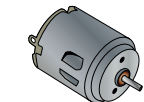

2 DIGITAL INPUTS



101011101011001...

...

3 ANALOG INPUTS 0...5V

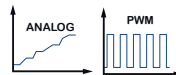

...

DOWNLOAD SAMPLE CODE FROM KA05 PAGE ON WWW.VELLEMAN.BE

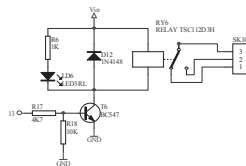
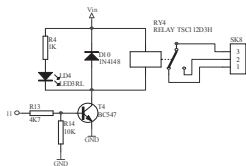
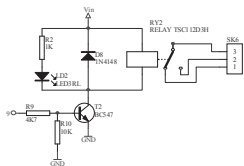
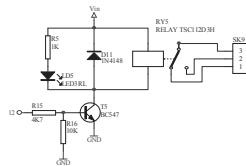
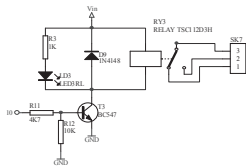
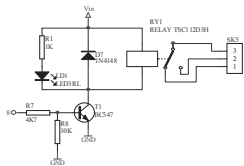
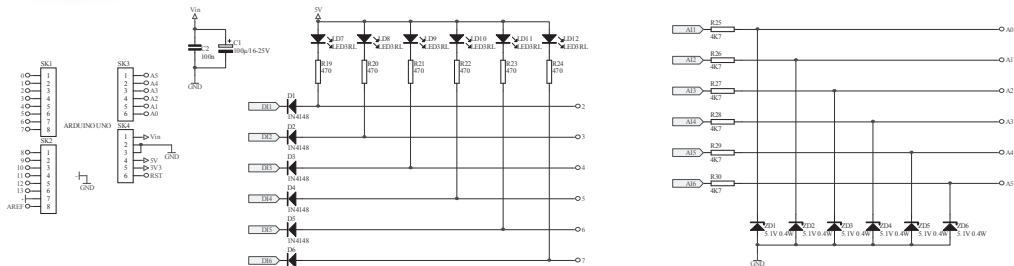

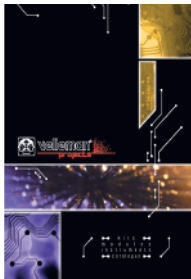

The new Velleman Projects catalogue is
now available. Download your copy here:
www.vellemanprojects.eu



Modifications and typographical errors reserved - © Velleman nv. HVMA05 (rev.2)
Velleman NV, Legen Heirweg 33 - 9890 Gavere.