

## MM74C08 Quad 2-Input AND Gate

### General Description

The MM74C08 employs complementary MOS (CMOS) transistors to achieve wide power supply operating range, low power consumption and high noise margin, these gates provide basic functions used in the implementation of digital integrated circuit systems. The N- and P-channel enhancement mode transistors provide a symmetrical circuit with output swing essentially equal to the supply voltage. No DC power other than that caused by leakage current is consumed during static condition. All inputs are protected from damage due to static discharge by diode clamps to  $V_{CC}$  and GND.

### Features

- Wide supply voltage range: 3.0V to 15V
- Guaranteed noise margin: 1.0V
- High noise immunity:  $0.45 V_{CC}$  (typ.)
- Low power TTL compatibility:  
Fan out of 2 driving 74L
- Low power consumption: 10 nW/package (typ.)

### Ordering Code:

Order Number	Package Number	Package Description
MM74CD8N	N14A	14-Lead Plastic Dual-In-Line Package (PDIP), JEDEC MS-001, 0.300" Wide

### Connection Diagram

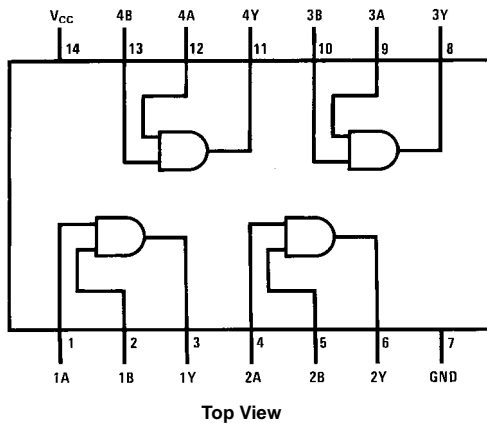

### Truth Table

Inputs		Outputs
A	B	Y
L	L	L
L	H	L
H	L	L
H	H	H

H = HIGH Level  
L = LOW Level

**Absolute Maximum Ratings**(Note 1)

Voltage at Any Pin	-0.3V to $V_{CC} + 0.3V$
Operating Temperature Range	-55°C to +125°C
Storage Temperature Range	-65°C to +150°C
Power Dissipation ( $P_D$ )	
Dual-In-Line	700 mW
Small Outline	500 mW
Operating $V_{CC}$ Range	3.0V to 15V
Absolute Maximum $V_{CC}$	18V
Lead Temperature (Soldering, 10 seconds)	260°C

**Note 1:** "Absolute Maximum Ratings" are those values beyond which the safety of the device cannot be guaranteed. Except for "Operating Temperature Range" they are not meant to imply that the devices should be operated at these limits. The Electrical Characteristics table provides conditions for actual device operation.

**DC Electrical Characteristics**

Min/Max limits apply across the guaranteed temperature range, unless otherwise noted

Symbol	Parameter	Conditions	Min	Typ	Max	Units
<b>CMOS TO CMOS</b>						
$V_{IN(1)}$	Logical "1" Input Voltage	$V_{CC} = 5.0V$	3.5			V
		$V_{CC} = 10V$	8.0			
$V_{IN(0)}$	Logical "0" Input Voltage	$V_{CC} = 5.0V$			1.5	V
		$V_{CC} = 10V$			2.0	
$V_{OUT(1)}$	Logical "1" Output Voltage	$V_{CC} = 5.0V, I_O = -10 \mu A$	4.5			V
		$V_{CC} = 10V, I_O = -10 \mu A$	9.0			
$V_{OUT(0)}$	Logical "0" Output Voltage	$V_{CC} = 5.0V, I_O = 10 \mu A$			0.5	V
		$V_{CC} = 10V, I_O = 10 \mu A$			1.0	
$I_{IN(1)}$	Logical "1" Input Current	$V_{CC} = 15V, V_{IN} = 15V$		0.005	1.0	$\mu A$
$I_{IN(0)}$	Logical "0" Input Current	$V_{CC} = 15V, V_{IN} = 0V$	-1.0	-0.005		$\mu A$
$I_{CC}$	Supply Current	$V_{CC} = 15V$		0.01	15	$\mu A$
<b>CMOS/LPTTL INTERFACE</b>						
$V_{IN(1)}$	Logical "1" Input Voltage	74C, $V_{CC} = 4.75V$	$V_{CC} - 1.5$			V
$V_{IN(0)}$	Logical "0" Input Voltage	74C, $V_{CC} = 4.75V$			0.8	V
$V_{OUT(1)}$	Logical "1" Output Voltage	74C, $V_{CC} = 4.75V, I_O = -360 \mu A$	2.4			V
$V_{OUT(0)}$	Logical "0" Output Voltage	74C, $V_{CC} = 4.75V, I_O = 360 \mu A$			0.4	V
<b>OUTPUT DRIVE (see Family Characteristics Data Sheet) <math>T_A = 25^\circ C</math> (short circuit current)</b>						
$I_{SOURCE}$	Output Source Current (P-Channel)	$V_{CC} = 5.0V, V_{OUT} = 0V$	-1.75	-3.3		mA
$I_{SOURCE}$	Output Source Current (P-Channel)	$V_{CC} = 10V, V_{OUT} = 0V$	-8.0	15		mA
$I_{SINK}$	Output Sink Current (N-Channel)	$V_{CC} = 5.0V, V_{OUT} = V_{CC}$	1.75	3.6		mA
$I_{SINK}$	Output Sink Current (N-Channel)	$V_{CC} = 10V, V_{OUT} = V_{CC}$	8.0	16		mA

## AC Electrical Characteristics (Note 2)

(MM74C08)  $T_A = 25^\circ\text{C}$ ,  $C_L = 50\text{ pF}$ , unless otherwise specified

Symbol	Parameter	Conditions	Min	Typ	Max	Units
$t_{pd0}$ , $t_{pd1}$	Propagation Delay Time to Logical "1" or "0"	$V_{CC} = 5.0\text{V}$		80	140	ns
		$V_{CC} = 10\text{V}$		40	70	
$C_{IN}$	Input Capacitance	(Note 3)		5.0		pF
$C_{PD}$	Power Dissipation Capacitance	(Note 4) Per Gate		14		pF

**Note 2:** AC Parameters are guaranteed by DC correlated testing.

**Note 3:** Capacitance is guaranteed by periodic testing.

**Note 4:**  $C_{PD}$  determines the no load AC power consumption of any CMOS device. For complete explanation see Family Characteristics Application Note—AN-90.

## Typical Performance Characteristics

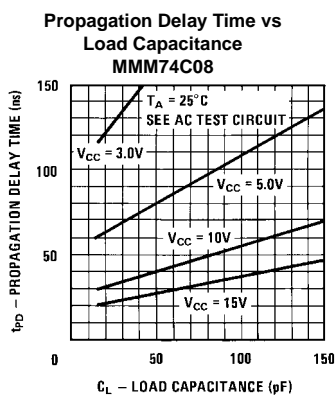

## AC Test Circuit

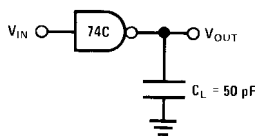

**Note:** Delays measured with input  $t_r$ ,  $t_f = 20\text{ ns}$

## Switching Time Waveforms

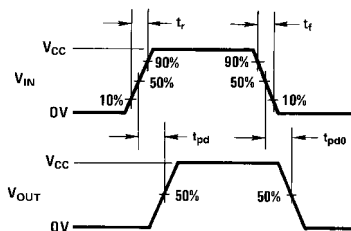

**Physical Dimensions** inches (millimeters) unless otherwise noted

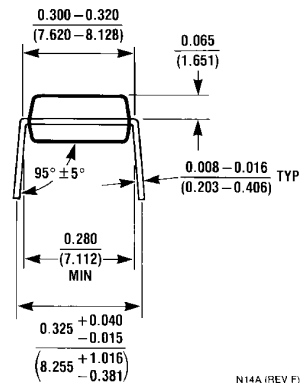
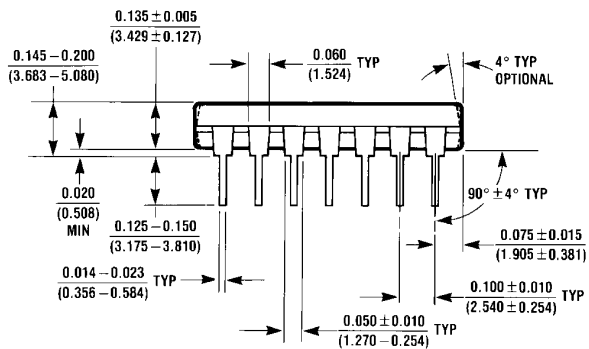
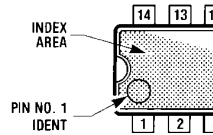
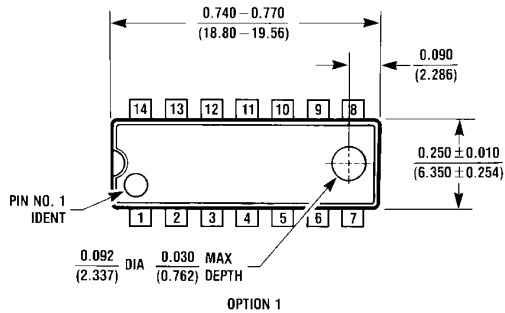

N14A (REV F)

14-Lead Plastic Dual-In-Line Package (PDIP), JEDEC MS-001, 0.300" Wide Package Number N14A

Fairchild does not assume any responsibility for use of any circuitry described, no circuit patent licenses are implied and Fairchild reserves the right at any time without notice to change said circuitry and specifications.

**LIFE SUPPORT POLICY**

FAIRCHILD'S PRODUCTS ARE NOT AUTHORIZED FOR USE AS CRITICAL COMPONENTS IN LIFE SUPPORT DEVICES OR SYSTEMS WITHOUT THE EXPRESS WRITTEN APPROVAL OF THE PRESIDENT OF FAIRCHILD SEMICONDUCTOR CORPORATION. As used herein:

1. Life support devices or systems are devices or systems which, (a) are intended for surgical implant into the body, or (b) support or sustain life, and (c) whose failure to perform when properly used in accordance with instructions for use provided in the labeling, can be reasonably expected to result in a significant injury to the user.
2. A critical component in any component of a life support device or system whose failure to perform can be reasonably expected to cause the failure of the life support device or system, or to affect its safety or effectiveness.

[www.fairchildsemi.com](http://www.fairchildsemi.com)