

RDC[®]
Interconnect Products & Tools
for Networks

RADIALL 
The next connexion

CONTENTS

Subject	Page
Introduction	2
Dimensions Table AWG	3
BNC series and BNC ECO series	4
TNC series	8
N series and N ECO series	9
F series	11
Terminations	12
FME series and UHF series	12
DIN 1.6/5.6 ECO series en DIN 1.0/2.3 ECO series	14
7/16 ECO series	16
Accessories for coaxial connectors (protector sleeves and solder tags)	16
BNC cable assemblies	18
BNC - HDTV cable assemblies	19
D-SUB series	19
Fiber Optic connectors (SC, ST, LC, LxC-R®, LUXCIS) and accessories	21
Fiber Optic cable assemblies	24
Twisted pair components (plugs, keystone jacks, adapters, adapter kits, etc)	28
Twisted pair patch cables	34
Patch panels	35
Tools and tool kits	38
Communication networks: components and cabling	42
Overview of required pairs for various applications	45
Mounting instructions for modular plugs and jacks: R280MOD807/R280MOD803A/R280MOD800	46
Mounting instructions R280MOD810	48
Mounting instructions R280MOD830	49
Mounting instructions R280MOD831	50
Assembly instructions HDMI plug and coaxial connectors	52
Panel cut out	54
Stripping dimensions	55
Product review	56

INTRODUCTION

We have the pleasure to present our fully updated catalogue "RDC® Interconnect Products & Tools for Networks

Radiall is a global manufacturer of interconnect components including RF-coaxial connectors and cable assemblies, antennas, multipin connectors, microwave and fibre optic components. The company has 13 sites to provide global support to their customers.

This catalogue focuses on applications within several communication markets:

DATA - TELE – VIDEO – MOBILE & WIRELESS COMMUNICATIONS

In this catalogue we present a number of our standard coaxial connector series as well as a selection of Radiall's ECO-series, which have attractive pricing and adjusted specifications.

The chapter 'twisted pair components' has been extended with CAT 6A products to respond to the request to have faster networks and higher capacity to transmit more data in less time.

Fibre Optics has already been in use in backbone applications for a long time. Today, use of fibre is increasingly being used in LAN and even in industrial applications. The chapter 'Fibre Optics' has been updated accordingly and has been extended with ECO fibre optic cable assemblies.

Besides, the catalogue includes background information about networks and cabling systems.

We have made an effort to supply technical data as complete and detailed as possible. If you wish to have additional information or further explanations, please contact our local representative.

For additional product information, please visit our website www.radiall.com.

The information supplied is intended solely as guidelines. With the purpose to guarantee continuous improvement of our products, Radiall preserve the right to modify specifications and descriptions without further notice on forehand.

AWG Dimensions Table

AWG	Wire outer diameter		Wire Section	
	Inch	mm	sq inch	mm ²
10	0,102	2,588	0,008	5,260
11	0,091	2,305	0,007	4,162
12	0,081	2,053	0,005	3,309
13	0,072	1,828	0,004	2,624
14	0,064	1,628	0,003	2,081
15	0,057	1,450	0,002	1,650
16	0,051	1,291	0,002	1,309
17	0,045	1,150	0,002	1,038
18	0,040	1,024	0,001	0,823
19	0,036	0,912	0,001	0,653
20	0,032	0,812	0,001	0,512
21	0,029	0,723	0,001	0,411
22	0,025	0,644	0,000	0,326
23	0,023	0,573		0,258
24	0,020	0,511		0,205
25	0,018	0,455		0,162
26	0,016	0,405		0,129
27	0,014	0,361		0,102
28	0,013	0,321		0,081
29	0,011	0,286		0,064
30	0,010	0,255		0,051
31	0,009	0,227		0,040
32	0,008	0,202		0,032

TO CONVERT:

MM – INCH

Millimeter to inch: multiply by 0,03937
 Centimeter to inch: multiply by 0,3937
 Meter to inch: multiply by 39,37

INCH – MM

Inch to millimeter: divide by 0,03937
 Inch to centimeter: divide by 0,3937
 Inch to meter: divide by 39,37

THE STANDARD RADIO SPECTRUM

HF 3MHz – 30MHz
 VHF 30 MHz – 300 MHz
 UHF 300 MHz – 1.0 GHz
 L 1.0 GHz – 2.0 GHz
 S 2.0 GHz – 4.0 GHz
 C 4.0 GHz – 8.0 GHz
 X 8.0 GHz – 12.0 GHz
 Ku 12.0 GHz – 18.0 GHz
 K 18.0 GHz – 27.0 GHz
 Ka 27.0 GHz – 40.0 GHz

NEW INDICATION OF FREQUENCY

A 250 MHz – 500 MHz
 B 500 MHz – 1.0 GHz
 C 1.0 GHz – 2.0 GHz
 E 2.0 GHz – 3.0 GHz
 F 3.0 GHz – 4.0 GHz
 G 4.0 GHz – 6.0 GHz
 H 6.0 GHz – 8.0 GHz
 I 8.0 GHz – 10.0 GHz
 J 10.0 GHz – 20.0 GHz
 K 20.0 GHz – 40.0 GHz
 L 40.0 GHz – 60.0 GHz
 M 60.0 GHz – 100.0 GHz

BNC series

COUPLING	Bayonet
IMPEDANCE	50, 75 , 93 Ohm
FREQUENCY RANGE	DC – 4 GHz (50 Ohm), DC – 1,5 GHz (versions –161), DC – 1 GHz (75 Ohm)
TYPICAL VSWR	1.30 straight versions, 1.35 right angle versions
PLATING BODY	Nickel
PLATING CENTER CONTACT	Gold

See page 55 for stripping dimensions.

PLUGS

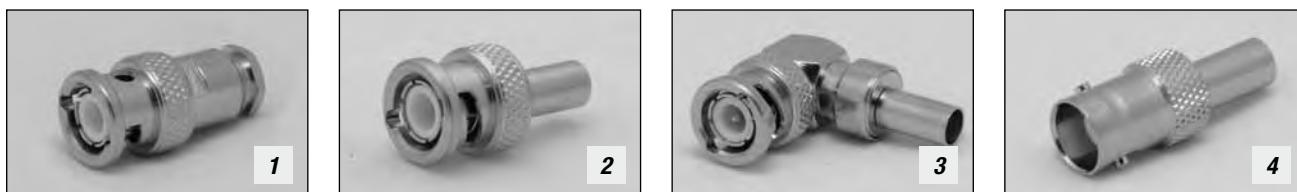

Part Number	Cable/RG type	Description	PU	Fig.
R141007161	58	male, straight, clamp type	100	1
R141007161W	58	male, straight, clamp type	1	1
R141075161	174	male, straight, crimp type	100	2
R141075161W	174	male, straight, crimp type	1	2
R141082161	58	male, straight, crimp type	100	2
R141082161W	58	male, straight, crimp type	1	2
R141082500	58	male, straight, crimp type, insulated	1	
R141182161	58	male, right angle, half crimp type	100	3
R141182161W	58	male, right angle, half crimp type	1	3
R141237161	58	female, straight, crimp type	100	4
R141237161W	58	female, straight, crimp type	1	4

JACKS

Part Number	Cable/RG type	Description	PU	Panel cut out (page 54)
R141332161	58	female, straight bulkhead, crimp type, 1-hole	100	5
R141332161W	58	female, straight bulkhead, crimp type, 1-hole	1	5

FLANGE RECEPTACLES



Part Number	Description	PU	Fig.	Panel cut out (page 54)
R141404000	female, solder, square flange	1	1	7
R141557000W	female, solder, 1-hole	1	2	1
R141559000	female, solder, 1-hole	1	3	1
R141563161	female, solder, 1-hole, silver plated contact	100	4	1
R141563161W	female, solder, 1-hole, silver plated contact	1	4	1
R141574161	female, solder, 1-hole, insulated	100	5	1
R141574161W	female, solder, 1-hole, insulated	1	5	1

PCB RECEPTACLES



Part Number	Description	PU	Panel cut out (page 54)
R141426161	female, straight, for PCB	100	9
R141426161W	female, straight, for PCB	1	9

ADAPTERS



Part Number	Description	PU	Fig.	Panel cut out (page 54)
R141703000W	male-male	1	1	
R141704000W	female-female	1	2	
R141723161	idem, insulated	100	3	2
R141780000	Tee-adaptor, male/female-female	1	4	
R141795000	Y-block male/female-female	1	5	

PLUGS



Part Number	Cable/RG type	Description	PU	Fig.
R142016161	59	male, straight, clamp type	100	1
R142016161W	59	male, straight, clamp type	1	1
R142085161	59	male, straight, crimp type	100	2
R142085161W	59	male, straight, crimp type	1	2
R142184161	59	male, right angle, half crimp type	100	
R142184161W	59	male, right angle, half crimp type	1	
R142242161	59	female, straight, crimp type	100	3
R142242161W	59	female, straight, crimp type	1	3
R142090000		male, straight, crimp type for coax 12	100	4
R142086161W		male, straight crimp type for Bedea HD9+ and Koka 799	1	4

JACKS



Part Number	Cable/RG type	Description	PU	Fig.	Panel cut out (page 54)
R142334161	59/62	female, straight bulkhead, crimp type, 1-hole	100	1	5
R142334161W	59/62	female, straight bulkhead, crimp type, 1-hole	1	1	5

FLANGE RECEPTACLES



Part Number	Description	PU	Panel cut out (page 54)
R142562000	female, bulkhead, solder, 1-hole	1	1

ADAPTERS



Part Number	Description	PU	Fig.	Panel cut out (page 54)
R142703000W	male-male	1	1	
R142704000W	female- female	1	2	
R142720000W	female-female, bulkhead, 1-hole	1	3	2
R142780000W	male/female-female Tee adapter	1	4	

BNC HDTV 75 OHM



Part Number	Cable/RG type	Description	PU
R142077732W	6	male, straight, crimp type, for Belden HDTV RG6 cable	1

More plugs, receptacles and many different coloured sleeves available upon request.

Available soon: BNC Composite HD



Please contact us for more information regarding this product line.

BNC ECO series

COUPLING	Bayonet
IMPEDANCE	50, 75 Ohm
FREQUENCY RANGE	DC – 1 GHz
TYPICAL VSWR	1.30 at 1 GHz (straight versions)
PLATING BODY	Nickel
PLATING CENTER CONTACT	Gold 0.1 µm (typical)

See page 55 for stripping dimensions.

PLUGS



Part Number	Cable/RG type	Description	PU	Fig.
R141A075161	174	male, straight, crimp type	100	1
R141A075161W	174	male, straight, crimp type	1	1
R141A082161	58	male, straight, crimp type	100	2
R141A082161W	58	male, straight, crimp type	1	2

BULKHEAD JACKS

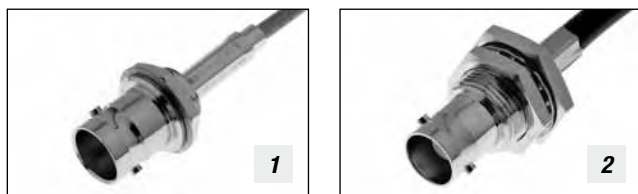

Part Number	Cable/RG type	Description	PU	Fig.
R141A306000	174	female, straight, crimp type, 1-hole. Max. panel cut out 9,75x8,9 mm	100	1
R141A306000W	174	female, straight, crimp type, 1-hole. Max. panel cut out 9,75x8,9 mm	1	1
R141A332161	58	female, straight, crimp type, 1-hole. Max. panel cut out 12,9x11,95 mm	100	2
R141A332161W	58	female, straight, crimp type, 1-hole. Max. panel cut out 12,9x11,95 mm	1	2

IN SERIES ADAPTERS



Part Number	Description	PU
R141A720000	female-female, bulkhead, 1-hole. Max. panel cut out 12,8x12,15 mm	100
R141A720000W	female-female, bulkhead, 1-hole. Max. panel cut out 12,8x12,15 mm	1

PLUGS

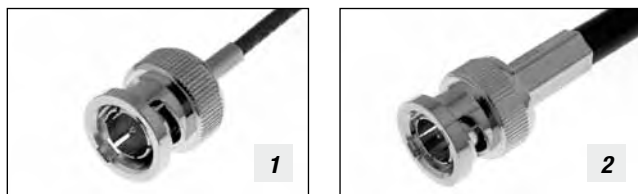

Part Number	Cable/RG type	Description	PU	Fig.
R142A076161	174	male, straight, crimp type	100	1
R142A076161W	174	male, straight, crimp type	1	1
R142A085161	59	male, straight, crimp type	100	2
R142A085161W	59	male, straight, crimp type	1	2

BULKHEAD JACKS

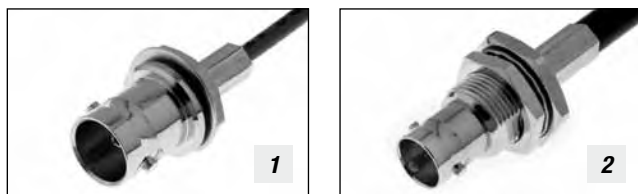

Part Number	Cable/RG type	Description	PU	Fig.
R142A306500	174	female, straight, crimp type, 1-hole. Max. panel cut out 9,7x8,85 mm	100	1
R142A306500W	174	female, straight, crimp type, 1-hole. Max. panel cut out 9,7x8,85 mm	1	1
R142A334161	59	female, straight, crimp type, 1-hole. Max. panel cut out 12,9x10,85 mm	100	2
R142A334161W	59	female, straight, crimp type, 1-hole. Max. panel cut out 12,9x10,85 mm	1	2

TNC series

COUPLING	Screw on
IMPEDANCE	50, 75 Ohm
FREQUENCY RANGE	DC – 11 GHz (50 Ohm), DC – 1,5 GHz (versions –161), DC – 1,5 GHz (75 Ohms)
TYPICAL VSWR	1.30 (straight versions)
PLATING BODY	Nickel
PLATING CENTER CONTACT	Gold

See page 55 for stripping dimensions.

PLUGS



Part Number	Cable/RG type	Description	PU	Fig.
R143007161	58	male, straight, clamp type	100	1
R143075161	174	male, straight, crimp type	100	
R143075161W	174	male, straight, crimp type	1	
R143082000W	58	male, straight, crimp type	1	
R143082161	58	male, straight, crimp type	100	
R143082161W	58	male, straight, crimp type	1	
R143083161	142	male, straight, crimp type	100	
R143156000	58	male, right angle, clamp type	1	2
R143181161	174	male, right angle, crimp type	100	3
R143181161W	174	male, right angle, crimp type	1	3
R143182161	58	male, right angle, crimp type	100	3
R143182161W	58	male, right angle, crimp type	1	3
R143235161W	58	female, straight, crimp type	1	4

JACKS



Part Number	Cable/RG type	Description	PU	Fig.	Panel cut out (page 54)
R143331161	174	female, straight bulkhead, crimp type, 1-hole	100	1	2
R143331161W	174	female, straight bulkhead, crimp type, 1-hole	1	1	2
R143332161	58	female, straight bulkhead, crimp type, 1-hole	100	1	2
R143332161W	58	female, straight bulkhead, crimp type, 1-hole	1	1	2

RECEPTACLES



Part Number	Description	PU	Fig.	Panel cut out (page 54)
R143563161	female, bulkhead, solder, 1-hole	100	1	1
R143563161W	female, bulkhead, solder, 1-hole	1	1	1
R143574161	female, bulkhead, solder, 1-hole, insulated	100	2	1
R143574161W	female, bulkhead, solder, 1-hole, insulated	1	2	1

ADAPTERS



Part Number	Description	PU	Fig.	Panel cut out (page 54)
R143703000	male-male	1		
R143704000	female-female	1	1	
R143720161	female-female, bulkhead, 1-hole	100		2
R143780000	male/female-female Tee adapter	1		

PLUGS



Part Number	Cable/RG type	Description	PU
R144085000	59	male, straight, crimp type	1
R144085161	59	male, straight, crimp type	100
R144085161W	59	male, straight, crimp type	1

JACKS



Part Number	Cable/RG type	Description	PU	Panel cut out (page 54)
R144334161	59	female, straight, crimp type, 1-hole	100	2
R144334161W	59	female, straight, crimp type, 1-hole	1	2

N series

COUPLING	Screw on
IMPEDANCE	50 Ohm
FREQUENCY RANGE	DC – 11 GHz
TYPICAL VSWR	1.30 (straight versions)
PLATING BODY	BBR
PLATING CENTER CONTACT	Gold

See page 55 for stripping dimensions.

PLUGS



Part Number	Cable/RG type	Description	PU	Fig.
R161008000W	58	male, straight, clamp type	1	1
R161020000W	213/214	male, straight, clamp type, model UG 21 E/U	1	1
R161022000W	213/214	same, model UG 1185 A/U captive contact	1	1
R161075000W	213	male, straight, crimp type	1	2
R161076000W	-	male, straight, crimp type (Ethernet cable)	1	2
R161082000W	58	male, straight, crimp type	1	2
R161088000W	214	male, straight crimp type	1	2

JACKS



Part Number	Cable/RG type	Description	Fig.
R161237000W	58	female, straight, crimp type	1
R161241000W	214	female, straight, crimp type	1
R161243000W	213	female, straight, crimp type	1

ADAPTERS



Part Number	Description	PU	Fig.	Panel cut out (page 54)
R161703000W	male – male	1		
R161705000W	female-female UG 29 B/U	1	1	
R161715000W	female-female, square flange	1		8
R161753000W	same, bulkhead, 1-hole UG 30 D/U	1	2	6
R161780000W	male/female-female Tee-adaptor, UG 107 B/U	1	3	
R161782000W	female/female-female Tee-adaptor, UG 28 A/U	1	4	

N ECO series

COUPLING	Screw on
IMPEDANCE	50 Ohm
FREQUENCY RANGE	DC – 6 GHz
TYPICAL VSWR	1.20 at 6 GHz (straight versions)
PLATING CONNECTOR BODY	BBR
PLATING CENTER CONTACT	Gold 0.1 µm (typical)

See page 55 for stripping dimensions.

STRAIGHT PLUGS



Part Number	Cable/RG type	Description	PU	Fig.
R161A082000	58/141	male, straight, crimp type	50	1
R161A083000	142/223/400	male, straight, crimp type	50	2
R161A075000	213	male, straight, crimp type	50	3
R161A088000	214	male, straight, crimp type	50	4

RIGHT ANGLE PLUGS

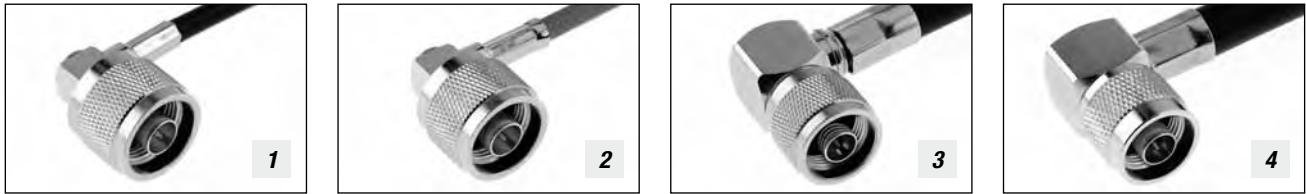

Part Number	Cable/RG type	Description	PU	Fig.
R161A182000	58/141	male, right angle, crimp type	50	1
R161A183000	142/223/400	male, right angle, crimp type	50	2
R161A184000	213	male, right angle, crimp type	50	3
R161A186000	214	male, right angle, crimp type	50	4

RECEPTACLES



Part Number	Description	PU	Fig.
R161A606010	female, rear mount, panel seal, solder pot. Max. panel cut out 16,1x13,7 mm	50	1
R161A404000	male, square flange, solder pot. Panel cut out see fig. 4	50	2
R161A410000	male, square flange, solder pot. Panel cut out see fig. 5	50	3

F series

COUPLING	Screw on
IMPEDANCE	75 Ohm
FREQUENCY RANGE	DC – 2 Ghz
TYPICAL VSWR	1.35
PLATING BODY	Nickel
PLATING CENTER CONTACT	Gold

PLUGS



Part Number	Cable/RG type	Description	PU	Fig.
R396400052	coax 6	F male crimp type	1	1
R396400055	59	F male crimp type	1	2
R396400056	coax 12	F male crimp type with a fixed ferrule	1	3
R396400080	59	F male screw type	1	4
R396400081	coax 12	F male screw type	1	4
R396400082	coax 12/HD9+ and Koka 799	F male crimp type with a loose ferrule	1	5

ADAPTERS



Part Number	Description	PU	Fig.
R396400053	Adapter F female – BNC male	1	1
R396400054	Adapter F female – BNC female	1	2
R396400071	Adapter F male – BNC male	1	3

TERMINATIONS (or Dummy Loads)



Part Number	Description	PU
R404441000W	BNC male, 50 Ohm, frequency up to 1 GHz, 1W ave	1
R404441120	Same, with chain, 7 cm	1
R404442000W	BNC male, 75 Ohm, frequency up to 1 GHz, 1W ave	1
R404442120	Same, with chain, 7 cm	1
R404443000	BNC male, 93 Ohm, frequency up to 1 GHz, 1W ave	1

Radiall has a wide range of terminations for specific applications. Please consult us if you have a request for high power, high frequency, other impedance or other connector types.

FME connect system for use in mobile communications

The FME connect system consists of a number of rotating plugs and adapters to easily create or adapt (external) antenna connections for mobile communication systems

In most cases, plugs are crimped onto RG58 (50 Ohm) cable. The interface enables the connection to the adapters, thus creating a smooth adaptation to a range of common plug interfaces. These plugs provide connection between different kinds of mobile phones and accessories.

PLUG



Part Number	Cable/RG type	Description	PU
R280357000	58	female plug, straight, crimp type	1

ADAPTERS

Part Number	Description	PU
R280370000W	male-male, straight, bulkhead	1
R125042000W	straight, FME connect male - SMA male	1
R141042000W	straight, FME connect male - BNC male	1
R143042000W	straight, FME connect male - TNC male	1
R155042000W	straight, FME connect male - UHF male	1

UHF series

COUPLING	Screw on type with dents to prevent rotation
IMPEDANCE	50 Ohm
FREQUENCY RANGE	DC – 0,5 GHz
PLATING BODY	Nickel
PLATING CENTER CONTACT	Silver

PLUGS



Part Number	Cable/RG type	Description	PU	Fig.
R155004161	213	male, straight, clamp type: PL 259/9	1	
R155005161	59	male, straight, clamp type: PL 259/6	1	
R280207161		clamp to adjust to 5 mm: UG 175/U	1	
R280211161		clamp to adjust to 6 mm: UG 176/U	1	
R155073161	58	male, straight, crimp type: PL 259/5c	100	
R155074161	59	male, straight, crimp type: PL 259/6c	1	1
R155075161	213	male, straight, crimp type: PL 259/10c	1	

RECEPTACLES



Part Number	Description	PU	Fig.	Panel cut out (page 54)
R155404161	female, straight, square flange: SO 239	1	1	8
R155560161	female, straight, 1-hole: SO 239 SH	1		11

ADAPTERS



Part Number	Description	PU	Fig.
R155705161	female-female, for cable extension	1	1
R155770161	male-female, right angle version	1	
R191445000	UHF female – BNC male, UG 255/U	1	
R191447000	UHF male – BNC female, UG 273/U	11	
R191447000	UHF male – BNC female, UG 273/U	1	

DIN 1.6 / 5.6 ECO series

COUPLING	Screw on
IMPEDANCE	75 Ohm
FREQUENCY RANGE	DC – 1 GHz
PLATING BODY	Nickel
PLATING CENTER CONTACT	Gold 0.05 µm typical

See page 55 for stripping dimensions.

STRAIGHT PLUGS



Part Number	Cable/RG type	Description	PU	Fig.
R129A010215	S3 + S4	male, straight, clamp type	100	1
R129A074000	179/187	male, straight, crimp type	100	2
R129A083000	L910/34	male, straight, crimp type	100	3

RIGHT ANGLE PLUGS



Part Number	Cable/RG type	Description	PU	Fig.
R129A160215	S3 + S4	male, right angle, clamp type	100	1
R129A184000	59/140	male, right angle, crimp type	100	2

JACK



Part Number	Cable/RG type	Description	PU
R129A347000	59/140	female, straight bulkhead, crimp type, 1-hole. Max. panel cut out 9,2x8,2 mm	100

PCB RECEPTACLES

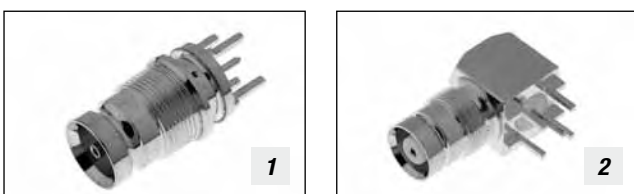

Part Number	Description	PU	Fig.
R129A576030	female, straight	100	1
R129A666000	female, right angle	100	2

ADAPTER



Part Number	Description	PU
R129A770500	Y- adapter, male – male – female	100

DIN 1.0 / 2.3 ECO series

COUPLING	Screw on / Slide on
IMPEDANCE	50 Ohm
FREQUENCY RANGE	DC – 4 GHz
PLATING BODY	Nickel
PLATING CENTER CONTACT	Gold 0.1 µm typical

See page 55 for stripping dimensions.

STRAIGHT PLUGS



Part Number	Cable/RG type	Description	PU	Fig.
R118A074215	2.6/50	male, straight, crimp type, screw on	100	1
R120A074215	2.6/50	male, straight, crimp type, slide on	100	2

STRAIGHT BULKHEAD JACKS



Part Number	Cable/RG type	Description	PU	Fig.
R118A311215	2.6/50	female, straight, 1-hole, screw on . Max. panel cut out 5,7x4,65 mm	100	1
R120A311215	2.6/50	female, right angle, 1-hole, slide on. Max. panel cut out 5,7x4,65 mm	100	2

PCB RECEPTACLES



Part Number	Description	PU	Fig.
R118A570000	female, straight	100	1
R118A680800	female, right angle	100	2

Unit packaging: add W after the part number e.g. R118A074215W.

7/16 ECO series

COUPLING	Screw on
IMPEDANCE	50 Ohm
FREQUENCY RANGE	DC – 3 GHz
TYPICAL VSWR	1.10 at 3 GHz (straight versions) 1.20 at 3 GHz (right angle versions)
PLATING BODY	BBR / Silver
PLATING CENTER CONTACT	Silver

See page 55 for stripping dimensions.

PLUGS



Part Number	Cable/RG type	Description	PU	Fig.
R185A010000	213/214/225	male, straight, clamp type	20	1
R185A010000W	213/214/225	male, straight, clamp type	1	1
R185A160000	213/214/225	male, right angle, clamp type	20	2
R185A160000W	213/214/225	male, right angle, clamp type	1	2
R185A174000	213	male, right angle, crimp type	20	3
R185A174000W	213	male, right angle, crimp type	1	3

JACKS



Part Number	Cable/RG type	Description	PU
R185A310000	213/214/225	female, straight bulkhead, clamp type. Max. panel cut out 29,2 mm	20
R185A310000W	213/214/225	female, straight bulkhead, clamp type. Max. panel cut out 29,2 mm	1

ADAPTER



Part Number	Description	PU
R185A770000W	male – female, right angle	1

Accessories for Coaxial connectors (protector sleeves and solder tags)

PROTECTOR SLEEVES FOR CABLE DIAMETER 5 MM

SERIES: BNC, TNC, N

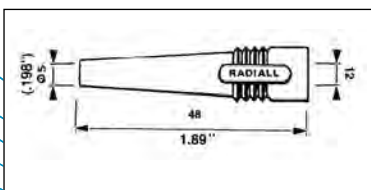

Part Number	Description	Colour	PU
R280570010	PVC sleeve	Black	10
R280571000	PVC sleeve	Red	10
R280572000	PVC sleeve	Green	10
R280573000	PVC sleeve	Blue	10
R280574000	PVC sleeve	Yellow	10
R280575000	PVC sleeve	Grey	10
R280576000	PVC sleeve	White	10
R280577000	PVC sleeve	Brown	10
R280578000	PVC sleeve	Orange	10
R280579000	PVC sleeve	Purple	10
R280580000	PVC sleeve	Transparent	10

PROTECTOR SLEEVES FOR CABLE DIAMETER 6 MM

SERIES: BNC, TNC, N

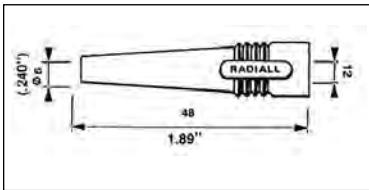

Part Number	Description	Colour	PU
R280590000	PVC sleeve	Black	10
R280591000	PVC sleeve	Red	10
R280592000	PVC sleeve	Green	10
R280593000	PVC sleeve	Blue	10
R280594000	PVC sleeve	Yellow	10
R280595000	PVC sleeve	Grey	10
R280596000	PVC sleeve	White	10
R280597000	PVC sleeve	Brown	10
R280598000	PVC sleeve	Orange	10
R280599000	PVC sleeve	Purple	10
R280600000	PVC sleeve	Transparent	10

PROTECTOR SLEEVES FOR CABLE DIAMETER 2,6 MM

SERIES: BNC, TNC

Part Number	Description	Colour	PU
R280566000	PVC sleeve	Black	10
R280566001	PVC sleeve	Red	10
R280566002	PVC sleeve	Green	10
R280566003	PVC sleeve	Blue	10
R280566004	PVC sleeve	Yellow	10
R280566005	PVC sleeve	Grey	10
R280566006	PVC sleeve	White	10
R280566007	PVC sleeve	Brown	10
R280566008	PVC sleeve	Orange	10

PROTECTOR SLEEVES FOR CABLE DIAMETER 2,6 MM **MINIATURE SERIES SMB, SMC**



Part Number	Description	Colour	PU
R280560000	PVC sleeve	Black	10
R280560001	PVC sleeve	Red	10
R280560002	PVC sleeve	Green	10
R280560003	PVC sleeve	Blue	10
R280560004	PVC sleeve	Yellow	10
R280560005	PVC sleeve	Grey	10
R280560006	PVC sleeve	White	10

SOLDER TAGS

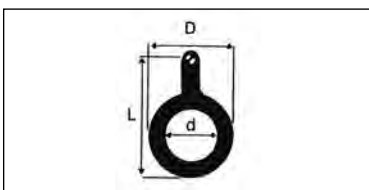

Part Number	Description	PU
R280490020W	To be used with: R141557000, R141563161, R142562000, R143557000	1

BNC Cable Assemblies

STANDARD BNC CABLE ASSEMBLIES 50 OHM

Connectors : 2 x R141082161

Cable : RG58

Sleeve black : R280570000



Part Number	Description	Length	PU
R296441025	BNC male – RG58 – BNC male	25 cm	1
R296441050	BNC male – RG58 – BNC male	50 cm	1
R296441075	BNC male – RG58 – BNC male	75 cm	1
R296441100	BNC male – RG58 – BNC male	100 cm	1
R296441150	BNC male – RG58 – BNC male	150 cm	1
R296441200	BNC male – RG58 – BNC male	200 cm	1
R296441300	BNC male – RG58 – BNC male	300 cm	1
R296441400	BNC male – RG58 – BNC male	400 cm	1
R296441500	BNC male – RG58 – BNC male	500 cm	1

STANDARD BNC CABLE ASSEMBLIES 75 OHM

Connectors : 2 x R142085161

Cable : RG59

Sleeve black : R280590000



Part Number	Description	Length	PU
R296442025	BNC male – RG59 – BNC male	25 cm	1
R296442050	BNC male – RG59 – BNC male	50 cm	1
R296442075	BNC male – RG59 – BNC male	75 cm	1
R296442100	BNC male – RG59 – BNC male	100 cm	1
R296442150	BNC male – RG59 – BNC male	150 cm	1
R296442200	BNC male – RG59 – BNC male	200 cm	1
R296442300	BNC male – RG59 – BNC male	300 cm	1
R296442400	BNC male – RG59 – BNC male	400 cm	1
R296442500	BNC male – RG59 – BNC male	500 cm	1

BNC HDTV CABLE ASSEMBLIES 75 OHM

Connectors : 2 x R14207722

Cable : blue 6/75/D

Sleeve red : 2 x R280591000

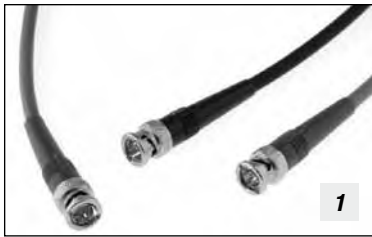

Part Number	Description	PU	Fig.
R296701393	BNC HDTV male – 6/75/D – BNC HDTV male, length 9 cm	1	1
R296701394	BNC HDTV male – 6/75/D – BNC HDTV male, length 18 cm	1	
R296701395	BNC HDTV male – 6/75/D – BNC HDTV male, length 30 cm	1	

Cable assemblies can be customized by choosing cable length, cable type (RG178, RG174, RG179, etc.), sleeve colour (see page 'accessories') etc. Alternative connector types are MCX, SMA, SMB, SMC, SMP, TNC, Twinax, etc.

See also www.radiall.com, link "Quick Access" and select Service+; this program will provide pricing for your specific cable assembly.

SUB – D series

APPLICATION : Industrial and datacom applications using removable crimp contacts

MATERIALS : Tin plated steel shell; glass filled nylon insulator, (UL94V-0 classified material); gold plated stamped contacts

VOLTAGE RATING : 300 V rms

CURRENT RATING max. 5 A per contact

DURABILITY : 200 cycles; male connector with indents to provide improved continuity

CABLE : AWG 24-26

SN SERIES



Part Number	Description	PU	Fig.
SNE 9 PS 102	male shell for 9 crimp contacts	10	
SNA 15 PS 102	male shell for 15 crimp contacts	10	1
SNB 25 PS 102	male shell for 25 crimp contacts	10	
SNC 37 PS 102	male shell for 37 crimp contacts	5	
SND 50 PS 102	male shell for 50 crimp contacts	3	
SNA 9 S 102	female shell for 9 crimp contacts	10	
SNA 15 S 102	female shell for 15 crimp contacts	10	
SNB 25 S 102	female shell for 25 crimp contacts	10	
SNC 37 S 102	female shell for 37 crimp contacts	5	
SND 50 S 102	female shell for 50 crimp contacts	3	

Contacts for SN Series (AWG 24 – 26), to be ordered separately:

TEP 12026 S 101	male stamped contacts	100	2
TES 12026 S 101	female stamped contacts	100	3

SUB – D series

APPLICATION : Industrial applications, using solder contacts
 MATERIALS : Tin plated steel shells; PBT & Glass fibre reinforced insulation material, UL94V-0 classified; gold plated turned contacts
 VOLTAGE RATING : 300 V rms
 CURRENT RATING : max. 5 A per contact
 DURABILITY : 200 cycles; male connector with indents to provide improved continuity
 CABLE : Max. AWG 20

NE SERIES



Part Number	Description	PU	Fig.
NEZ 9 PES 102	male connector with 9 solder contacts	10	
NAZ 15 PES 102	male connector with 15 solder contacts	10	1
NBZ 25 PES 102	male connector with 25 solder contacts	10	
NCZ 37 PES 102	male connector with 37 solder contacts	5	
NDZ 50 PES 102	male connector with 50 solder contacts	3	
NEZ 9 SE 102	female connector with 9 solder contacts	10	
NAZ 15 SE 102	female connector with 15 solder contacts	10	2
NBZ 25 SE 102	female connector with 25 solder contacts	10	
NCZ 37 SE 102	female connector with 37 solder contacts	5	
NDZ 50 SE 102	female connector with 50 solder contacts	3	

PLASTIC CAP (TWO PARTS), LATCH COUPLING, SCREW LOCKING WITH LONG AND FIXED SCREWS. CABLE DIAMETER MAX: 8,5 MM



Part Number	Description	PU
TCTC9	for D-Sub connectors with 9 positions	10
TCTC15	for D-Sub connectors with 15 positions	10
TCTC25	for D-Sub connectors with 25 positions	10
TCTC37	for D-Sub connectors with 37 positions	10

METAL CAP (TWO PARTS), SCREW LOCKING WITH SHORT AND FIXED SCREWS. CABLE DIAMETER MAX: 10 MM



Part Number	Description	PU
T88301	for D-Sub connectors with 9 positions	10
T88311	for D-Sub connectors with 15 positions	10
T88321	for D-Sub connectors with 25 positions	10
T88331	for D-Sub connectors with 37 positions	10

LOCKING SCREWS, DICHROMATED STEEL (STANDARD VERSION)

Part Number	Screw thread for female:	Dimension A	Dimension B	Dimension C	PU
TD 8630-01	female M3	13,5	8,5	5	100
TD 8630-30	female M3, for 50 positions	18	13	5	100

	Crimp Series	Industrial Series
Series	SN	N*E
Shell	Zinc dichromated or tin plated steel	Tin plated steel
Insulator	Glass filled nylon	PBT & Glass-fibre reinforced
Contact	Bronze	Brass
Contact plating active zone	Gold over nickel	Gold over nickel
Contact plating termin. Zone	Gold or tin over nickel	Gold or tin over nickel
Contact termination	Crimp removable	Solder cup
Removable contact	Yes	No
Contact dia. (mm)	1	1
Cable gauge	AWG 24-26	AWG 24-26
Nbr of cycle	200	200
Max voltage in V RMS 50 Hz	1000	1000
Rated voltage in V RMS 50 Hz	300	300
Max current rating per contact (A)	5	5
Insulation resistance	1000 m Ω min at 500 V DC	1000 m Ω min at 500 V DC
Contact resistance	< 10 m Ω	< 10 m Ω
Operating temperature range Humidity	-55 °C to +105 °C	-55 °C to +105 °C
UL	Meets UL norm	Meets UL norm

FIBER OPTIC CONNECTORS SC, ST

MATING TYPE	: SC: push-pull ST: bayonet with slanting slot
FERRULE TYPE	: 20 mm pre-radius
INSERTION LOSS	: SC: typ. 0,25 dB ST: typ. 0,15 dB
NUMBER OF MATINGS	: 1000 times
MECHANICAL SPECIFICATIONS	: 10N retention force on buffered fiber or tube 100N retention force on cable

CABLE PLUGS ST



Part Number	Diam.	Description	PU
F709024000	0,9-3 mm	ST2, ceramic 20mm ferrule, fiber 50/125 of 62,5/125 micron	1
F709024200	0,9-3 mm	same	100
F709097200	0,9-3 mm	ST2, ceramic pre-radius 20mm ferrule, fiber 50/125 of 62,5/125 micron	100

CABLE PLUGS SC



Part Number	Kabel diam.	Description	PU
F728003100	0,9 mm	SC, ceramic pre-radius 20 mm ferrule, fiber 50/125 of 62,5/125 micron	1
F728003700	3,0 mm	SC, ceramic pre-radius 20 mm ferrule, fiber 50/125 of 62,5/125 micron	1

IN-SERIES ADAPTERS ST



Part Number	Description	PU	Panel cut out (page 54)
F709722000	ST panel feed-through, female-female, metal sleeve	1	3
F709730000	ST panel feed-through, female-female, ceramic sleeve	1	3

IN-SERIES ADAPTERS SC

Part Number	Description	PU	Panel cut out (page 54)
F728700700	SC panel feed-through, female-female, ceramic sleeve	1	13
F728700800	SC panel feed-through, female-female, metal sleeve	1	13

IN-SERIES ACCESSOIRES

Part Number	Description	PU
F709750000	Metal protection cover for ST connectors	1
F709760000	Metal protection cover for ST connectors, with chain	1

LC CONNECTORS

MATING TYPE	: RJ45 click connection
FERRULE TYPE	: 1,25 mm precisions ceramic ferrule
INSERTION LOSS	: According to IEC 61300-3-4 methode B: Min: < 0,2 dB, max. < 0,4 dB
NUMBER OF MATINGS	: 200 times
MECHANICAL SPECIFICATIONS	: 0,9 mm: 7 N retention force 1,6 mm: 68 N retention force

CABLE PLUGS



Part Number	Diam.	Description	PU
F727103100	0,9 mm	LCPC 128 micron, simplex, multimode, beige	100
F727103500	2,0 mm	LCPC 128 micron, simplex, multimode, beige	100
F727102100	0,9 mm	LCPC 126 micron, simplex, multimode, blue	100
F727102500	2,0 mm	LCPC 126 micron, simplex, multimode, blue	100

IN-SERIES ADAPTERS



Part Number	Description	PU	Pco* (page 54)
F727751700	LCPC , duplex multimode adapter, beige, RJ45 cut-out	100	14
F727751000	LCPC , duplex singlemode adapter, blue, RJ45 cut-out	100	14
F727752000	LCPC, duplex singlemode adapter, blue, SC cut-out, with panel mount	100	13
F727752800	LCPC, duplex singlemode adapter, beige, SC cut-out, with panel mount	100	13

Detailed catalogue available upon request.
For Telecom applications, please ask for our singlemode versions. Other versions upon request.

Pco* = Panel cut out



LxC-R® en LUXCIS®

The LxC-R® has been qualified to withstand shocks and vibrations at high levels. Specifically designed to be compatible with the Industry Standard LuxCis® Arinc 801 fiber optic termini, the LxC-R® is very reliable with regard to mechanical- environmental- and optical performance. The flexibility of LuxCis® enables the use of multimode and singlemode fibers both for PC as well as APC for high data transmission.

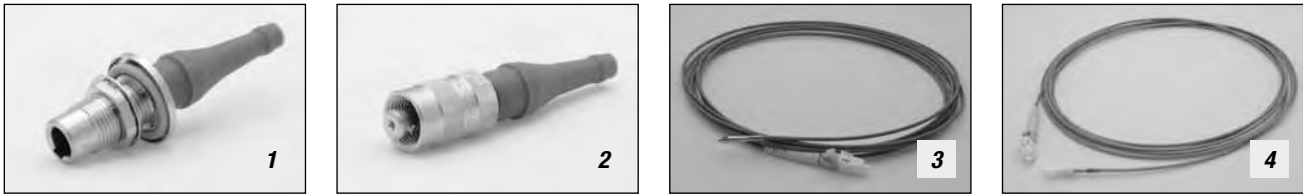

Part Number	Description	PU	Fig.
LXCRN1C1CL1N	Fiber Optic connector LxC-R®, plug, for fiber OM1/2/3	1	1
LXCRP1C1BL1N	Fiber Optic connector LxC-R®, jack, for fiber OM1/2/3	1	2
LUXCISMM23LC L 3M	Fiber Optic patchcable, multimode, LxC-R® - LC, for Telecom applications	1	3
LUXCISMM52LC L 3M	Fiber Optic patchcable, multimode, LxC-R® - LC, for Industrial applications	1	4

Fiber Optic accessoires

PANELS



Artikelnummer	Omschrijving	PU	Fig.
R396400F11	Fiber Optic drawer OV-A, 19", 1HU, RAL 7035, 12-way SC duplex front	1	1
R396400F12	Fiber Optic drawer OV-A, 19", 1HU, RAL 7035, 24-way SC simplex/LC duplex front	1	2
R396400F13	Fiber Optic drawer OV-A, 19", 1HU, RAL 7035, 24-way ST front	1	3

ACCESSOIRES

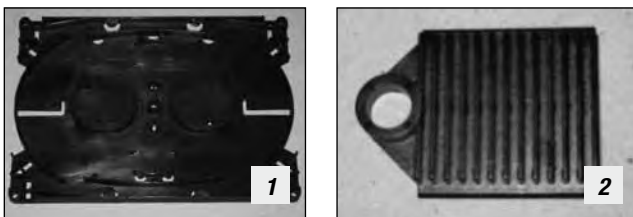

Part Number	Description	PU	Fig.
R396400F05	Junction box , large model	1	1
R396400F06	Cover, transparent for SK121	1	
R396400F07	Splice holder for ANT crimp	1	2
R396400F08	ANT crimp splice protection	1	
R396400F10	Sealing stickers	1	

FIBER OPTIC CABLE ASSEMBLIES – ECO series

GENERAL

	SC	LC	ST
Standard:	IEC 6175-4	IEC61754-20	IEC 61754-2
Duplex clip:	removable	removable	-
Mechanical endurance:	200 matings	200 matings	500 matings

Cable structure:

2mm/3mm cable diam. : tight buffer
 900µm buffer : loose tube
 Fiber 50/125 : OM2
 Fiber 62,5/125 : OM1
 Single mode : OS1

Specifications:

Insertion loss (according to IEC61300-3 -4) : 0,5 dB
 Return loss : Multimode PC > 20dB - Singlemode UPC >50dB - Singlemode APC >60dB
 Temperature range : -20°C / +70°C
 Cable retention : Buffer: 7 N - 2mm kabel: 68 N - 3m kabel: 100 N

Identification colour boots:

	Simplex			Duplex		
	Multimode	Singlemode UPC	Singlemode APC	Multimode	Singlemode UPC	Singlemode APC
LC	Beige	Blue	Green	Black/Red	Black/Blue	Black/Green
SC	Beige	Blue	Green	Black/Red	Black/Blue	Black/Green
ST	Black	Blue	-	Black/Red	Black/Red	-

SET OF 12 COLOURED PIGTAILS / 900 µM / LENGTH 2 M.

Colours buffer: red, green, blue, yellow, white, grey, brown, purple, aqua, black, orange, pink

Part Number	Connector	Fiber type
ESC9X12C09S2M	SCUPC	Singlemode 9/125
ESCA9X12C09S2M	SCAPC	Singlemode 9/125C
ESC50X12C09S2M	SC	Multimode 50/125
ESC62X12C09S2M	SC	Multimode 62,5/125
ELC9X12C09S2M	LCUPC	Singlemode 9/125
ELCA9X12C09S2M	LCAPC	Singlemode 9/125C
ELC50X12C09S2M	LC	Multimode 50/125
ELC62X12C09S2M	LC	Multimode 62,5/125

PIGTAIL 900 µM, LENGTH 2 M.

Part Number	Connector	Colour buffer	Fiber type
ELC50XC092M	LC	Green	Multimode 50/125
ELC62XC092M	LC	Blue	Multimode 62,5/125
ELC9XC092M	LCUPC	Yellow	Singlemode 9/125
ELCA9XC092M	LCAPC	Yellow	Singlemode 9/125
ESC50XC092M	SC	Green	Multimode 50/125
ESC62XC092M	SC	Blue	Multimode 62,5/125
ESC9XC092M	SCUPC	Yellow	Singlemode 9/125
ESCA9XC092M	SCAPC	Yellow	Singlemode 9/125
EST50XC092M	ST	Green	Multimode 50/125
EST62XC092M	ST	Blue	Multimode 62,5/125
EST9XC092M	ST	Yellow	Multimode 9/125



SC ADAPTERS

Part Number	Alignment sleeve	Colour shell	Type
EF728703800	PH/BR	beige	simplex
EF728703000	Ceraluc	blue	simplex
EF728703100	Ceramic	b-green	simplex
EF728743800	PH/BR	beige	duplex
EF728743000	Ceraluc	blue	duplex
EF728743100	Ceramic	b-green	duplex

LC ADAPTERS

Part Number	Alignment sleeve	Colour shell	Type	Hole size
EF727752800	PH/BR	beige	duplex	SC
EF727752000	Ceramic	blue	duplex	SC
EF727751802	PH/BR	beige	duplex	RJ45/LP

ST ADAPTERS

Part Number	Alignment sleeve	Type
EF709722000	PH/BR	simplex
EF709730000	Ceramic	simplex

DUPLEX PATCHCORDS

LC– LC Duplex Multimode 50/125 Cable dia. 2x2mm	LC– LC Duplex Multimode 62,5/125 Cable dia. 2x2mm	LCUPC-LCUPC duplex Singlemode 9/125 Cable dia. 2x2mm	LCAPC-LCAPC duplex Singlemode 9/125 Cable dia. 2x2mm	Length (meter)
ELC50LCC2D1M	ELC62LCC2D1M	ELC9LCC2D1M	ELCA9LCA2D1M	1
ELC50LCC2D2M	ELC62LCC2D2M	ELC9LCC2D2M	ELCA9LCA2D2M	2
ELC50LCC2D3M	ELC62LCC2D3M	ELC9LCC2D3M	ELCA9LCA2D3M	3
ELC50LCC2D5M	ELC62LCC2D5M	ELC9LCC2D5M	ELCA9LCA2D5M	5
ELC50LCC2D10M	ELC62LCC2D10M	ELC9LCC2D10M	ELCA9LCA2D10M	10
ELC50LCC2D15M	ELC62LCC2D15M	ELC9LCC2D15M	ELCA9LCA2D15M	15

SC– SC Duplex Multimode 50/125 Cable dia. 2x3mm	SC– SC Duplex Multimode 62,5/125 Cable dia. 2x3mm	SCUPC-SCUPC duplex Singlemode 9/125 Cable dia. 2x3mm	SCAPC-SCAPC duplex Singlemode 9/125 Cable dia. 2x3mm	Length (meter)
ESC50SCC3D1M	ESC62SCC3D1M	ESC9SCC3D1M	ESCA9SCA3D1M	1
ESC50SCC3D2M	ESC62SCC3D2M	ESC9SCC3D2M	ESCA9SCA3D2M	2
ESC50SCC3D3M	ESC62SCC3D3M	ESC9SCC3D3M	ESCA9SCA3D3M	3
ESC50SCC3D5M	ESC62SCC3D5M	ESC9SCC3D5M	ESCA9SCA3D5M	5
ESC50SCC3D10M	ESC62SCC3D10M	ESC9SCC3D10M	ESCA9SCA3D10M	10
ESC50SCC3D15M	ESC62SCC3D15M	ESC9SCC3D15M	ESCA9SCA3D15M	15

ST–ST Duplex Multimode 50/125 Cable dia. 2x3mm	ST–ST Duplex Multimode 62,5/125 Cable dia. 2x3mm	ST-ST duplex Singlemode 9/125 Cable dia. 2x3mm	Length (meter)
EST50STC3D1M	EST62STC3D1M	EST9STC3D1M	1
EST50STC3D2M	EST62STC3D2M	EST9STC3D2M	2
EST50STC3D3M	EST62STC3D3M	EST9STC3D3M	3
EST50STC3D5M	EST62STC3D5M	EST9STC3D5M	5
EST50STC3D10M	EST62STC3D10M	EST9STC3D10M	10
EST50STC3D15M	EST62STC3D15M	EST9STC3D15M	15

SC–ST Duplex Multimode 50/125 Cable dia. 2x3mm	SC– ST Duplex Multimode 62,5/125 Cable dia. 2x3mm	SC-ST duplex Singlemode kabel Cable dia. 2x3mm	Length (meter)
ESC50STC3D1M	ESC62STC3D1M	ESC9STC3D1M	1
ESC50STC3D2M	ESC62STC3D2M	ESC9STC3D2M	2
ESC50STC3D3M	ESC62STC3D3M	ESC9STC3D3M	3
ESC50STC3D5M	ESC62STC3D5M	ESC9STC3D5M	5
ESC50STC3D10M	ESC62STC3D10M	ESC9STC3D10M	10
ESC50STC3D15M	ESC62STC3D15M	ESC9STC3D15M	15

SC–LC Duplex Multimode 50/125 Cable dia. 2x2mm	SC– LC Duplex Multimode 62,5/125 Cable dia. 2x2mm	SC-LC duplex Singlemode 9/125 Cable dia. 2x2mm	Length (meter)
ESC50LCC2D1M	ESC62LCC2D1M	ESC9LCC2D1M	1
ESC50LCC2D2M	ESC62LCC2D2M	ESC9LCC2D2M	2
ESC50LCC2D3M	ESC62LCC2D3M	ESC9LCC2D3M	3
ESC50LCC2D5M	ESC62LCC2D5M	ESC9LCC2D5M	5
ESC50LCC2D10M	ESC62LCC2D10M	ESC9LCC2D10M	10
ESC50LCC2D15M	ESC62LCC2D15M	ESC9LCC2D15M	15

SCUPC – SCAPC Duplex Singlemode 9/125 Cable dia. 2x3mm	Length (meter)
ESC9SCA3CD1M	1
ESC9SCA3CD2M	2
ESC9SCA3CD3M	3
ESC9SCA3CD5M	5
ESC9SCA3CD10M	10
ESC9SCA3CD15M	15

LC–LC Simplex Multimode 50/125 Cable dia. 2x2mm	LC–LC Simplex Multimode 62,5/125 Cable dia. 2x2mm	LCUPC-LCUPC Simplex Singlemode 9/125 Cable dia. 2x2mm	LCAPC-LCAPC Simplex Singlemode 9/125 Cable dia. 2x2mm	Length (meter)
ELC50LCC2S1M	ELC62LCC2S1M	ELC9LCC2S1M	ELCA9LCACS1M	1
ELC50LCC2S2M	ELC62LCC2S2M	ELC9LCC2S2M	ELCA9LCACS2M	2
ELC50LCC2S3M	ELC62LCC2S3M	ELC9LCC2S3M	ELCA9LCACS3M	3
ELC50LCC2S5M	ELC62LCC2S5M	ELC9LCC2S5M	ELCA9LCACS5M	5
ELC50LCC2S10M	ELC62LCC2S10M	ELC9LCC2S10M	ELCA9LCACS10M	10
ELC50LCC2S15M	ELC62LCC2S15M	ELC9LCC2S15M	ELCA9LCACS15M	15

SC–SC Simplex Multimode 50/125 Cable dia. 2x2mm	SC–SC Simplex Multimode 62,5/125 Cable dia. 2x2mm	SCUPC-SCAPC Simplex Singlemode 9/125 Cable dia. 2x2mm	SCAPC-SCAPC Simplex Singlemode 9/125 Cable dia. 2x2mm	Length (meter)
ESC50SCC3S1M	ESC62SCC3S1M	ESC9SCC3S1M	ESCA9SCAC3S1M	1
ESC50SCC3S2M	ESC62SCC3S2M	ESC9SCC3S2M	ESCA9SCAC3S2M	2
ESC50SCC3S3M	ESC62SCC3S3M	ESC9SCC3S3M	ESCA9SCAC3S3M	3
ESC50SCC3S5M	ESC62SCC3S5M	ESC9SCC3S5M	ESCA9SCAC3S5M	5
ESC50SCC3S10M	ESC62SCC3S10M	ESC9SCC3S10M	ESCA9SCAC3S10M	10
ESC50SCC3S15M	ESC62SCC3S15M	ESC9SCC3S15M	ESCA9SCAC3S15M	15

ST-ST Simplex Multimode 50/125 Cable dia. 2x3mm	ST - ST Simplex Multimode 62,5/125 Cable dia. 2x3mm	ST-ST Simplex Singlemode 9/125 Cable dia. 2x3mm	Length (meter)
EST50STC3S1M	EST62STC3S1M	EST9ST3S1M	1
EST50STC3S2M	EST62STC3S2M	EST9ST3S2M	2
EST50STC3S3M	EST62STC3S3M	EST9ST3S3M	3
EST50STC3S5M	EST62STC3S5M	EST9ST3S5M	5
EST50STC3S10M	EST62STC3S10M	EST9ST3S10M	10
EST50STC3S15M	EST62STC3S15M	EST9ST3S15M	15

SC-ST Simplex Multimode 50/125 Cable dia. 2x3mm	SC- ST Simplex Multimode 62,5/125 Cable dia. 2x3mm	SCUPC-ST Simplex Singlemode 9/125 Cable dia. 2x3mm	Length (meter)
ESC50STC3S1M	ESC62STC3S1M	ESC9STC3S1M	1
ESC50STC3S2M	ESC62STC3S2M	ESC9STC3S2M	2
ESC50STC3S3M	ESC62STC3S3M	ESC9STC3S3M	3
ESC50STC3S5M	ESC62STC3S5M	ESC9STC3S5M	5
ESC50STC3S10M	ESC62STC3S10M	ESC9STC3S10M	10
ESC50STC3S15M	ESC62STC3S15M	ESC9STC3S15M	15

SC-LC Simplex Multimode 50/125 Cable dia. 2x2mm	SC- LC Simplex Multimode 62,5/125 Cable dia. 2x2mm	SCUPC-LCUPC Simplex Singlemode 9/125 Cable dia. 2x2mm	Length (meter)
ESC50LCC2S1M	ESC62LCC2S1M	ESC9LCC2S1M	1
ESC50LCC2S2M	ESC62LCC2S2M	ESC9LCC2S2M	2
ESC50LCC2S3M	ESC62LCC2S3M	ESC9LCC2S3M	3
ESC50LCC2S5M	ESC62LCC2S5M	ESC9LCC2S5M	5
ESC50LCC2S10M	ESC62LCC2S10M	ESC9LCC2S10M	10
ESC50LCC2S15M	ESC62LCC2S15M	ESC9LCC2S15M	15

SCUPC- SCAPC Duplex Singlemode 9/125 Cable dia. 2x3mm	Length (meter)
ESC9SCA3CS1M	1 meter
ESC9SCA3CS2M	2 meter
ESC9SCA3CS3M	3 meter
ESC9SCA3CS5M	5 meter
ESC9SCA3CS10M	10 meter
ESC9SCA3CS15M	15 meter

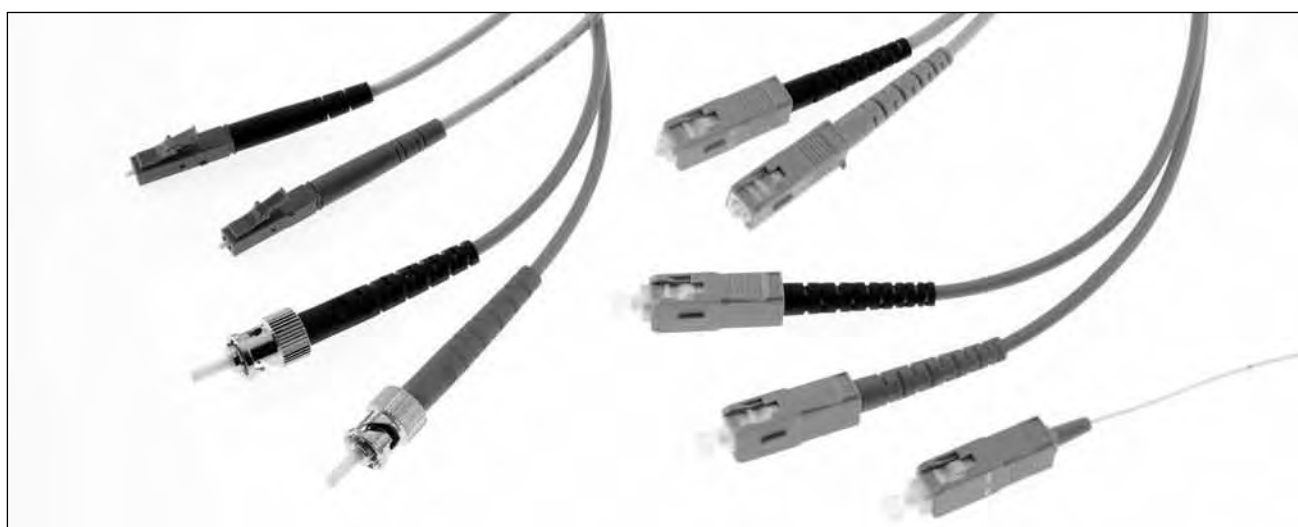

TWISTED PAIR COMPONENTS

RANGE	plugs, keystone jacks, shielded versions, adapters, adapter kits, tools, cable
COUPLING	Latching
STANDARDS	UL listing; some models to EIA/TIA TSB40
MATERIALS BODY	polycarbonate plastic, shock resistant and flame retardant, UL94V-0
MATERIALS CONTACTS	Bronze, Gold over Nickel plating
CABLE	AWG 24-26 (plugs) - AWG 24-28 (keystone jacks)
STRAIN RELIEF	Min. 89 N
DURABILITY	200 cycles for plugs and adapters - 750 cycles for jacks



PLUGS UL LISTED

FOR FLAT CABLE WITH FLEXIBLE CORE

Part Number	Cable AWG	Description (cable size = width x height)	PU
R280MOD4X4	24-26	Plug 4P4C, RJ10, cable size 5.0x2.4 mm	50
R280MOD6X4	24-26	Plug 6P4C, RJ11, cable size 5.0x2.4 mm	50
R280MOD6X6	24-26	Plug 6P6C, RJ12, cable size 7.0x2.5 mm	50
R280MOD6K6	24-26	Plug 6P6C, keyed, DEC compatible, cable size 7.0x2.5 mm	50
R280MOD748	24-26	Plug 8P10C, RJ48, cable size 8.8x2.5 mm	100

FOR ROUND CABLE WITH FLEXIBLE CORE

Part Number	Cable AWG	Description (cable size = width x height)	PU
R280MOD604	24-26	Plug 6P4C, RJ11, cable diameter 4.0-4.1 mm	50
R280MOD606	24-26	Plug 6P6C, RJ12, cable diameter 4.2-4.3 mm	50
R280MOD748	24-26	Plug 8P10C, RJ48, cable diameter up to 5.0 mm	100

FOR ROUND CABLE WITH RIGID CORE

Part Number	Cable AWG	Description (cable size = width x height)	PU
R280MOD4P4	24-26	Plug 4P4C, RJ10, cable diameter 4.0-4.1 mm	50
R280MOD6P4	24-26	Plug 6P4C, RJ11, cable diameter 4.0-4.1 mm	50
R280MOD6P6	24-26	Plug 6P6C, RJ12, cable diameter 4.2-4.3 mm	50
R280MOD6PK	24-26	Plug 6P6C, keyed, DEC compatible	50

FOR FLAT CABLE WITH FLEXIBLE CORE CAT. 5^E

Part Number	Cable AWG	Description (cable size = width x height)	PU
R280MOD8X8	24-26	Plug 8P8C, RJ45, cable size 8.8x2.5 mm	25

FOR ROUND CABLE WITH FLEXIBLE CORE CAT. 5^E

Part Number	Cable AWG	Description	PU
R280MOD808	24-26	Plug 8P8C, RJ45, cable diameter up to 5.0 mm	25

FOR ROUND CABLE WITH RIGID CORE CAT. 5^E

Part Number	Cable AWG	Description	PU
R280MOD8P8	24-26	Plug 8P8C, RJ45, cable diameter up to 5.0 mm	25

FOR ROUND CABLE WITH FLEXIBLE CORE CAT. 6

Part Number	Cable AWG	Description	PU
R280MOD8T8	24-26	Plug 8P8C, RJ45, cable diameter up to 5.0 mm	25



SHIELDED PLUGS UL LISTED

FOR FLAT OR ROUND CABLE WITH FLEXIBLE CORE CAT. 5^E

Part Number	Cable AWG	Description	PU
R280MOD8S8	24-26	Plug 8P8C, RJ45, cable diameter up to 5.3 mm	25

FOR ROUND CABLE WITH RIGID CORE CAT. 5^E

Part Number	Cable AWG	Description	PU
R280MOD8M8	24-26	Plug 8P8C, RJ45, cable diameter up to 5.3 mm	25

FOR ROUND CABLE WITH FLEXIBLE CORE CAT. 6

Part Number	Cable AWG	Description	PU
R280MOD8U8	24-26	Plug 8P8C, RJ45, cable diameter up to 5.3 mm	25



SLEEVES

FOR CAT 5^E CABLE

Part Number	Description	PU
R396400020	Sleeve for RJ45 plug, colour black, Ø 5,5 mm	10
R396401020	Sleeve for RJ45 plug, colour red, Ø 5,5 mm	10
R396402020	Sleeve for RJ45 plug, colour green, Ø 5,5 mm	10
R396403020	Sleeve for RJ45 plug, colour blue, Ø 5,5 mm	10
R396404020	Sleeve for RJ45 plug, colour yellow, Ø 5,5 mm	10
R396405020	Sleeve for RJ45 plug, colour grey, Ø 5,5 mm	10

FOR CAT 6 CABLE

Part Number	Description	PU
R396400030	Sleeve for RJ45 plug, colour black, Ø 6 mm	10
R396401030	Sleeve for RJ45 plug, colour red, Ø 6 mm	10
R396402030	Sleeve for RJ45 plug, colour green, Ø 6 mm	10
R396403030	Sleeve for RJ45 plug, colour blue, Ø 6 mm	10
R396404030	Sleeve for RJ45 plug, colour yellow, Ø 6 mm	10
R396405030	Sleeve for RJ45 plug, colour grey, Ø 6 mm	10

FOR SHIELDED KABEL

Part Number	Description	PU
R396400040	Sleeve for RJ45 plug, colour black, Ø 6,55 mm	10



JACKS

CAT 4 Data transmission speed up to 20 Mbps - UL listed - Snap-in mounting - Wires have an IDC connection (no stripping of cables)

Part Number	Cable AWG	Description	PU
R280MOD804	24-28	Keystone jack 6P6C, RJ12	1
R280MOD805	24-28	Keystone jack 8P8C, RJ45	1
R280MOD806	24-28	Keystone jack 6P6C, "keyed" DEC comp	1



CAT 5^E Data transmission speed up to 125 Mbps. - UL listed, snap-in mounting - Wire connection by use of 110 punch down tool (no cable stripping) - See mounting instructions and wiring diagram on page 46

Part Number	Cable AWG	Description	PU	Fig.	Panel cut out (page 54)
R280MOD807	22-26	Keystone jack 8P8C, RJ45. Connection can also be done with LSA+ tool.	1	1	10
R280MOD809	22-26	Idem, shielded version. IDC connection, T568B colour coded. Required depth needed for mounting: 4,5-5 cm.	1	2	10
R280MOD811	22-26	Idem, shielded, plastic housing	1	3	10



CAT 6 Data transmission speed up to 250 Mbps - UL listed, snap-in mounting - To be used with cable with flexible or rigid core

Part Number	Cable AWG	Description	PU	Fig.	Panel cut out (page 54)
R280MOD803A	22-26	Keystone jack 8P8C, RJ45, 110IDC mounting also for 19" patch panel R280MOD996	1	1	10
R280MOD802	22-26	Idem, shielded version	1	2	10
R280MOD800	22-26	Keystone jack 8P8C, RJ45, fast mounting technique	1	3	10



CAT 6^A See mounting instructions and wiring diagram on page 48-51

Part Number	Cable AWG	Description	PU	Fig.
R280MOD830	22-26	Keystone jack, fast mounting technique. Panel cut out 14,7x19,8 mm	1	1
R280MOD831	22-26	Idem, shielded version. Panel cut out 14,7x19,8 mm	1	2
R280MOD810	22-26	Shielded metal version, also for 19" patch panel R280MOD997. Panel cut out 14,6x19,1 mm	1	3

JUNCTION BOXES



Part Number	Cable AWG	Description	PU
R396400010	22-26	Shielded version, CAT 5 ^E	1
R396400019	22-26	Shielded version, CAT 6	1

WALL OUTLETS



Part Number	Description	PU	Fig.
R396400058	2-way housing, incl. 2 CAT 6 jacks	1	1
R396400019	4-way housing for R280MOD800	1	2

ADAPTERS AND TEE ADAPTERS

STRAIGHT CONNECTION (E.G. PIN 1 TO PIN 6) FOR TELECOM APPLICATIONS



Part Number	Description	PU	Fig.
R280MOD704	Adapter female-female, RJ11	1	1
R280MOD706	Adapter female-female RJ12	1	1
R280MOD708	Adapter female-female RJ45	1	1
R280MOD764	Tee adapter f/f/f RJ11	1	2
R280MOD766	Tee adapter f/f/f RJ12	1	2
R280MOD768	Tee adapter f/f/f RJ45	1	2
R280MOD785	Tee adapter m/f/f RJ11	1	3
R280MOD786	Tee adapter m/f/f RJ12	1	3
R280MOD788	Tee adapter m/f/f RJ45	1	3

CROSS CONNECTION (E.G. PIN 1 TO PIN 1) FOR ETHERNET APPLICATIONS



Part Number	Description	PU	Fig.
R280MOD716	Adapter female-female RJ12	1	1
R280MOD718	Adapter female-female RJ45	1	1
R280MOD778	Tee adapter f/f/f RJ45	1	2
R280MOD779	Tee adapter m/f/f RJ45	1	3
R280MOD735	CAT 5 ^E 45° adapter female-female	1	4
R280MOD736	CAT 6 45° adapter, female-female	1	5

D-SUB ADAPTER KITS



Select the required wiring arrangement from 9/15/25 pins male or female to a modular jack (select a wiring diagram)

D-Sub side: tinned housing and gold plated contacts

Part Number	Description	PU
R280MOD116	9 contacts male to RJ11/RJ12	1
R280MOD126	9 contacts female to RJ11/RJ12	1
R280MOD118	9 contacts male to RJ45	1
R280MOD128	9 contacts female to RJ45	1
R280MOD416	15 contacts male to RJ11/RJ12	1
R280MOD426	15 contacts female to RJ11/RJ12	1
R280MOD418	15 contacts male to RJ45	1
R280MOD428	15 contacts female to RJ45	1
R280MOD216	25 contacts male to RJ11/RJ12	1
R280MOD226	25 contacts female to RJ11/RJ12	1
R280MOD218	25 contacts male to RJ45	1
R280MOD228	25 contacts female to RJ45	1
R280MOD316	25 contacts male to 6P6C DEC	1
R280MOD326	25 contacts female to 6P6C DEC	1

CABLE FOR MODULAR PLUGS (FLAT CABLE 4, 6, 8 WIRES)

Conductors	: Stranded copper wire 26 (7 x 0,16 mm) Diameter 0,48 mm nom.
Insulator	: Polypropylene
Outer jacket	: PVC
Impedance	: max. 140 MOhm/km at 20°C
Insulation resistance	: min. 25 Mohm/km at 20°C
Dielectric withstanding voltage	: 1000 V AC
Working voltage	: 150 V

FLAT AND FLEXIBLE CABLE, UNSHIELDED

Part Number	Description	PU
R280MOD004	White, 4 conductors, on reel	100 meter
R280MOD006	White, 6 conductors, on reel	100 meter
R280MOD008	White, 8 conductors, on reel	100 meter
R280MOD014	Black, 4 conductors on reel	100 meter
R280MOD016	Black, 6 conductors on reel	100 meter
R280MOD018	Black, 8 conductors on reel	100 meter
R280MOD514	Black, 4 conductors, on reel	500 meter

FLAT AND FLEXIBLE CABLE, SHIELDED

Part Number	Description	PU
R280MOD114	Grey, 3 conductors, 1 earth wire, on reel	100 meter
R280MOD115	Grey, 5 conductors, 1 earth wire, on reel	100 meter
R280MOD117	Grey, 7 conductors, 1 earth wire, on reel	100 meter

HDMI PRODUCTS



Part Number	Description	PU	Fig.
R396400025	HDMI adapter	1	1
R396400026	HDMI plug, 19 contacts, solder (mounting instructions, see page 52)	1	2

LAN CABLE TESTER

The LAN cable tester is very practical in use. It displays the correct contact configuration of 10BaseT cable, 10Base-2 cable, RJ45/RJ11 modular cable, 258A, TIA-568A-B, Token Ring cable, etc. Testing is done by comparing the transmission signal on one side with the receiving signal on the other side of the cable.

The remote kit enables verification of the cable over longer distances on for instance wall outlet or patch panels. It is easy to test continuity, open end, short circuit or incorrect connection of cable pairs.



Part Number	Description	PU
R396410014	LAN cable tester	1



TWISTED PAIR PATCH CABLES

CAT. 5^E PATCH CABLES



Patch cables U/UTP or F/UTP RJ45 CAT 5E and 6, with overmoulded sleeves.

Wired according to T568B diagram.

The overmoulded sleeves provide improved strain relief (31 kg) and increased protection against bending.

AWG size CAT 5E U/UTP and F/UTP cable: AWG 26. CAT 6: AWG 25 (U/UTP) and AWG 26 (F/UTP)

Patch cables can also be supplied with coloured sleeves: grey, red, green, blue and yellow

Patch cables without sleeves, in which case strain relief is 21 kg are available upon request.

Part Number	Description	PU
896400055	2 x RJ45 on grey U/UTP, incl. black sleeves, length 0,50 m.	
896400014	length 1 m.	1
896400015	length 2 m.	1
896400016	length 3 m.	1
896400017	length 4 m.	1
896400018	length 5 m.	1
896400019	length 6 m.	1
896400020	length 7 m.	1
896400021	length 8 m.	1
896400022	length 9 m.	1
896400023	length 10 m.	1

Part Number	Description	PU
896400F01	2 x RJ45 on grey F/UTP, incl. black sleeves, length 1 m.	
896400F02	length 2 m.	1
896400F03	length 3 m.	1
896400F04	length 4 m.	1
896400F05	length 5 m.	1
896400F06	length 6 m.	1
896400F07	length 7 m.	1
896400F08	length 8 m.	1
896400F09	length 9 m.	1
896400F10	length 10 m.	1

CAT. 6 PATCH CABLES

Patch cables U/UTP or F/UTP RJ45 CAT 6, with overmoulded sleeves

Wired according to T568B diagram

The overmoulded sleeves provide improved strain relief (31 kg) and increased protection against bending.

AWG size CAT 5E U/UTP and F/UTP cable: AWG 26. CAT 6: AWG 25 (U/UTP) and AWG 26 (F/UTP)

Part Number	Description	PU
8964X3005	2 x RJ45 on grey U/UTP, incl. black sleeves, length 1 m.	
8964X3006	length 2 m.	1

Part Number	Description	PU
8964F3005	2 x RJ45 on grey U/UTP, incl. black sleeves, length 1 m.	
8964F3006	length 2 m.	1



PATCH PANELS

High density version, UL listed, meets EIA/TIA –TSB wiring according to T568B, using 110 punch down connection technology.

COMPLETE UNSHIELDED PANEL CAT 5^E, 19”



Part Number	Description	PU
R280MOD990	24 ports, RJ45, 1HU, unshielded	1

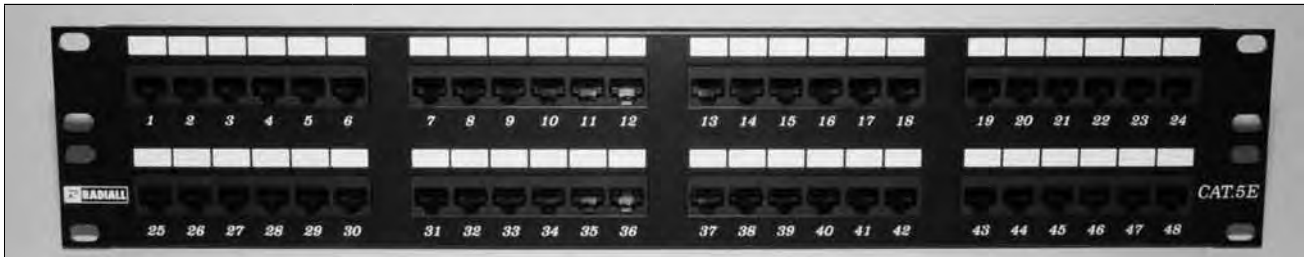

Part Number	Description	PU
R280MOD991	48 ports, RJ45, 2HU, unshielded	1

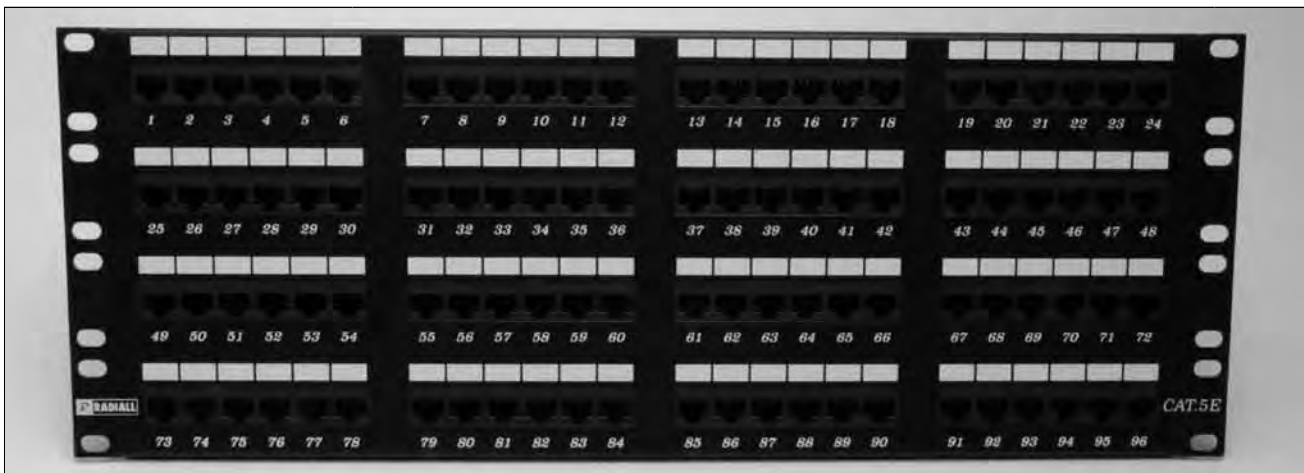

Part Number	Description	PU
R280MOD992	96 ports, RJ45, 4HU, unshielded	1

COMPLETE UNSHIELDED PANEL CAT 5^E, 10”



Part Number	Description	PU	Fig.
R280MOD993	10 ports, RJ45, 1HU, unshielded. Will be supplied with 10 loose jacks (R280MOD807), (not mounted). Preferably to be applied on 10” patch cabinet.	1	6

COMPLETE SHIELDED PANEL CAT 5^E, 19"



Part Number	Description	PU
R396PAT024	24 ports, RJ45, 1HU, shielded	1

COMPLETE UNSHIELDED PANEL CAT 6, 19"

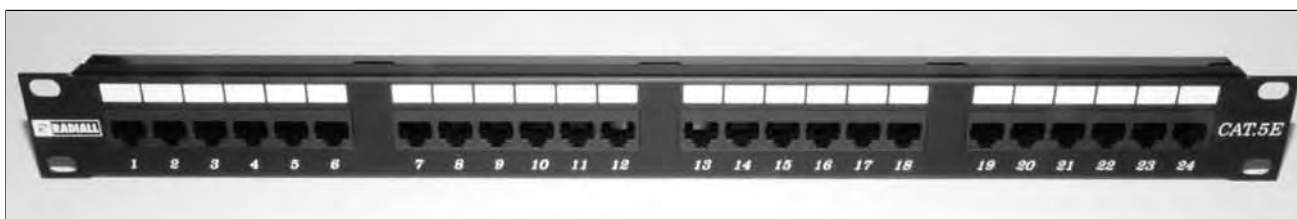

Part Number	Description	PU
R280MOD985	24 ports RJ45, 1HU, unshielded	1

COMPLETE SHIELDED PANEL CAT 6, 19"

Part Number	Description	PU
R396PAT026	24 ports RJ45, 1HU, shielded	1

COMPLETE UNSHIELDED PANEL CAT 6, 10"

Part Number	Description	PU
R280MOD989	10 ports, RJ45, 1HU, unshielded. Will be supplied with 10 loose jacks, 110 IDC technique, (not mounted). Preferably to be applied on 10" patch cabinet.	1

COMPLETE UNSHIELDED PANEL CAT 6 SMALL PANEL

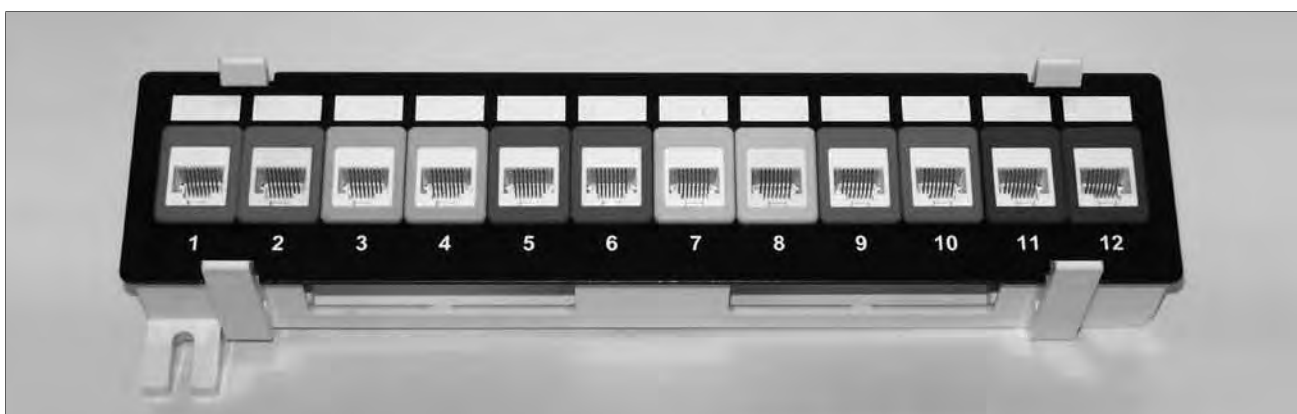

Part Number	Description	PU
R280MOD984	Mini panel, 12 coloured ports. Incl. 12 jacks, (not mounted), 110 IDC, unshielded. Provided with mounting bracket (to use in meter cupboard for example).	1

EMPTY PANEL UNSHIELDED CAT 6, 19"



Part Number	Description	PU
R280MOD996	24 ports, 1HU, for 24 jacks R280MOD803A. No jacks supplied.	1

EMPTY PANEL UNSHIELDED CAT 6^A, 19"

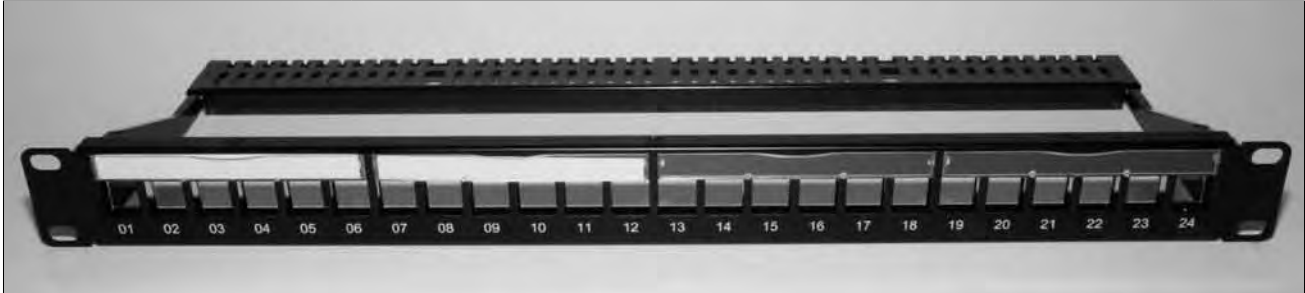

Part Number	Description	PU
R280MOD994	24 ports, 1HU, for 24 jacks R280MOD830. No jacks supplied.	1

EMPTY PANEL SHIELDED CAT 6^A, 19"

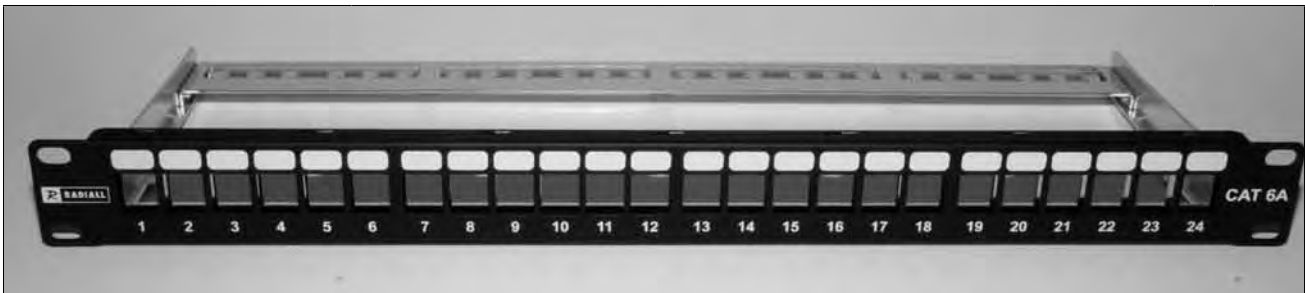

Part Number	Description	PU
R280MOD997	24 ports, 1HU for 24 jacks R280MOD810. No jacks supplied.	1

BLIND PANEL



Part Number	Description	PU
R280MOD995	Blind panel, 19", 1HU, black. Same version as R280MOD990.	1

CRIMP TOOLS FOR COAXIAL CONNECTORS

Specifications:

- MIL crimp T 22 910/55619
- 10.000 crimps guaranteed
- full crimp obligation : 100% connection
- includes emergency deblocking mechanism

Part Number	Description	PU
R282211000	for cable diameter 1, 2 or 2,6 mm. Hex: 2.67/3.25/4.52	1
R282223000	for cable diameter 5 or 6 mm. Hex: 1.73/5.41/6.48	1
R282227000	for cable diameter 8 mm. Hex: 1.73/8.23 and for R142086161W, R142090000	1
R282231000	for cable diameter 10 or 11 mm. Hex: 2.59/10.54	1
R282271000	for cable diameter 2.6 mm. Hex: 3.84/3.25. Square: 0.72	1
R282223999	dies for crimp tool R282223000	1
R396400060	universal crimp tool including four dies for: BNC, TNC, RJ11/12 and RJ45	1

STRIPPERS COAX



Cutter cassette	Stripping dimensions ¹⁾
Grey	3.9 mm = B
Red	6.0 mm = B
Yellow	12.0 mm = B
Blue	6.5 mm = B
Green	7.1 + 5.1 mm = C + B
Brown	7.5 + 3.5 mm = C + B

1) Dimension A in accordance with the plug stripping dimensions (not defined by the tool)

Two stage

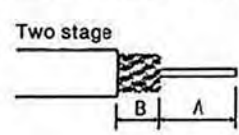

Three stage

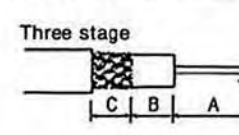

1

Part Number	Description	PU	Fig.
R299520000	basic stripping tool in which an interchangeable blade holder and screw holder are mounted; incl. R299522000; cable type 2.5 till 8 mm adjustable; two- or three steps stripping in one single action; FIXED stripping lengths by use of colour codes (separately supplied as stickers). Excl. blade holder.	1	1
R299521011	replacement blade red, two step	1	
R299521012	replacement blade green: three step	1	
R299521013	replacement blade blue: two step	1	
R299521014	replacement blade yellow: two step	1	
R299521015	replacement blade grey: two step	1	
R299521017	replacement blade: three step, for RG58 and RG59	1	
R299522000	adjustable blade for other cables with diameter 2,5 – 8 mm, 2 or 3 step	1	

TOOLS D-SUB



Part Number	Description	PU	Fig.
R282SUB399	crimp tool for crimping contacts AWG20 –28 (SN series)	1	
R282SUB400	stripper "pistol model" with interchangeable blades	1	
ET1828	insert extraction tool (SN series)	1	1

STRIPPERS MODULAR



Part Number	Description	PU	Fig.
R299550000	Stripping tool; For cable diameter up to 11 mm; Stripper can be used on all 10BaseT (AUI and Drop), PDS and IBM (type 1 & 6) cable.	1	1
R299551000	spare blade for R299550000	1	

CRIMP TOOLS



Part Number	Description	PU	Fig.
R280MOD304	crimp tool RJ10, metal	1	
R280MOD306	crimp tool RJ11/12, metal	1	1
R280MOD308	crimp tool RJ45, metal	1	
R280MOD346	crimp tool RJ10/11/12, plastic	1	2
R280MOD347	crimp tool RJ11/12/45, metal including stripping and cutting function, vertical position	1	3
R280MOD356	crimp tool 6P6C DEC, metal	1	

PROFESSIONAL CRIMP TOOL FOR MODULAR CONNECTORS



Part Number	Description	PU	Fig.
R280MOD395	three functions into one tool: Cutting, stripping and crimping; For cutting AWG24-28 cable; For crimping RJ10/RJ11/RJ12/RJ45; Rigid or flexible core. No failure as crimp procedure can only be stopped when crimping has been finished. The tool includes an emergency de-blocking mechanism. Vertical position.	1	1
R280MOD397	idem R280MOD395, for crimping RJ10/RJ11/RJ12/RJ48	1	
R396400005	spare blade for R280MOD395	1	
R396400060	universal crimp tool including four dies for BNC, TNC, RJ11/12 en RJ45	1	

PUNCH DOWN TOOL



Part Number	Description	PU	Fig.
R280MOD404	110 IDC punch down tool	1	1
R280MOD405	Spare blade for R280MOD404	1	

TOOL KITS MODULAR



Part Number	Description	PU
R396125000	<p>Contents: Metal crimping tool RJ10/11/12/45 R280MOD347 20 modular connectors RJ10 for flat cable 20 modular connectors RJ12 for flat cable 20 modular connectors RJ45 for flat cable</p> <p>Plugs provided should be used on cable with a flexible core.</p>	1



Part Number	Description	PU
R396126000	<p>Professional tool kit: professional crimp tool R280MOD395 cable stripper UTP/STP/FTP R299550000 10 modular connectors RJ10 for flat cable 10 modular connectors RJ12 for flat cable 10 modular connectors RJ45 for round cable</p> <p>Plugs provided should be used on cable with a flexible core.</p>	1



Part Number	Description	PU
R396127000	<p>Tool kit for data network applications: professional crimp tool R280MOD395 cable stripper R299550000 LAN cable tester R396410014 10 modular connectors RJ10 for flat cable 10 modular connectors RJ12 for flat cable 10 modular connectors RJ45 for round cable</p> <p>Plugs provided should be used on cable with a flexible core.</p>	1



Part Number	Description	PU
R396128000	<p>Tool kit universal crimp tool: crimp tool: R396400061 including four dies: RG179/RG174: R396400062 RG58/59/62: R396400063 RJ45: R396400064 RJ11/12: R396400065</p>	1

LAN CABLE TESTER

The LAN cable tester is practical in use. It displays the correct contact configuration of 10BaseT cable, 10Base-2 cable, RJ45/RJ11 modular cable, 258A, TIA-568A-B, Token Ring cable, etc. Testing is done by comparing the transmission signal on one side with the receiving signal on the other side of the cable.

The remote kit enables verification of the cable over longer distances on for instance wall outlet or patch panels. It is easy to test continuity, open end, short circuit or incorrect connection of cable pairs.



Part Number	Description	PU
R396410014	LAN cable tester	1



TOOL KITS BNC

Part Number	Description	PU
R282124050	Tool kit 50 Ohm R282223000: 1 crimp tool R141082161: 15 connectors R299520000: 1 stripper R299521017: 1 blade holder	1

Part Number	Description	PU
R282124075	Tool kit 75 Ohm R282223000: 1 crimp tool R142085161: 15 connectors R299520000: 1 stripper R299521017: 1 blade holder	1



TOOL KIT D-SUB

Part Number	Description
R282124SUB	R282SUB399 : crimp tool R282SUB400 : stripper ET1828 : insert extraction tool SNE9PS102 : 10 pcs male connectors, 9 contacts SNE9S102 : 10 pcs female connectors, 9 contacts SNA15PS102 : 10 pcs male connectors, 15 contacts SNA15S102 : 10 pcs female connectors, 15 contacts SNB25PS102 : 10 pcs male connectors, 25 contacts SNB25S102 : 10 pcs female connectors, 25 contacts TEP52026S101 : 500 contacts AWG 20-26 pin TES52026S101 : 500 contacts AWG 20-26 socket TES52026S101 : 500 contacts AWG 20-26 bus

Radiall manufactures and supplies a comprehensive range of connectors and components for data and telematics cabling. The portfolio offers components (twisted pair, d-sub, fiber optic and RF) and cable, mounting tools, specific mounting-kits, mounting material, patch panels, cable assemblies made-to-order and accessories.

This large portfolio addresses many different applications, in particular in data communication applications these components are used depending upon type and specifics of the network.

Lately it is noticeable that the required bandwidth is much more the cornerstone than the physical structure, all in relation to the required data usage of the network users. Which applications should be used today and in the near future, what requirements exist in terms of flexibility and future expansion to integrate IP products (cameras, entrance security systems, automatic patch-thru to audio-applications etc). The main thing is to establish an infrastructure which is independent of the final applications selected.

Developments towards higher transmission capacity and bandwidth.

There is a growing demand for networks with a high capacity enabling more data transportation in less time. In recent years, standard data cabling consisted of cat 5^E or D^E. This enabled a capacity of max. 1 Gb through 100 meter (90 + 10) horizontal cabling. It is ever more apparent that security requirements demand more due to the growing number of IP applications. The limits of the technical possibilities are pushed out continuously.

Consequently the infrastructure which should support these facilities is more and more subject to higher requirements and that over a longer period of time. And of course, this should not degrade flexibility and independence of the systems and its components.

In this respect a number of standards regarding structured cabling have been developed over the past few years. Some of these already existed but need to be modified. These are adjusted, better defined or extended in order to be used with the ever increasing requirements, such as installation requirements (EN-NEN 50174 I, II and III). Other standards are more recent or are only now applicable for data and telematics cabling.

What do these documents address?

- Construction of cabling infrastructure, systematic classification in subsystems and its parts
- Handling of construction and roll-out
- Generic specification of systems, classification in different classes of performance levels
- Specification of equipment, cabling and hardware (connectors, components, racks etc) also in relation with performance level if applicable

- Description of test- and measurement procedures and corresponding equipment to cover future applications
- EMC conditions and recommendations
- Systematic and requirements for the construction of a solid documentation of an installation, securing guarantee and responsibility.

To follow is a shortlist and description of some popular standards, being directly or indirectly common for structured cabling,

ISO/IEC 11801^{second edition} (including complements):

The international standard for generic cabling. This is comparable with TIA/EIA 568B but important in Europe for legal reasons, The content is nearly identical to the American standard. One difference for instance is the fact that ISO/IEC 11801 supports shielded cable right from the start. Fiber optic cable is also defined and specified. For some important issues there are a greater number of measurement criteria. The limit values that can be obtained are stricter. ISO/IEC 11801^{second edition} runs up to class F (500/600 MHz). The aim is to go up to class F^A (1000 MHz)

EN-NEN 50173^{second edition} (Cenelec including complements):

The European standard, has been derived from ISO/IEC, but there are specific differences from ISO/IEC with reference to EN-NEN 50174 (generic installation) in particular regarding grounding.

TIA/EIA 568B 1-3 (ANSI including complements):

American standard. In first instance designed for non-shielded cabling. However in the US less in use due to recent building requirements.

EN-NEN 50174 P1 to 3: European installation directives (Generic Installation standard)

For use inside and between buildings.

50174-1: Information Technology – installation of cabling Specification and quality assurance “Infrastructure Management” in relation with cable ducts, installation of cable, assembling components, racks and management of racks including cable patching at the front of the racks.

50174-2: Specifically designed for use inside buildings of copper- and fiber optic cabling.

50174-3: Refers to the use of cabling outside and between buildings.

DIN 44312-5: An existing German standard specifying cabling systems using twisted pair cable with individually and overall shielded pairs, for 2 and 4 pairs for use up to 600 MHz. for this reason probably setting the standard for future cat 7/class F standards.

DIN 41494 en IEC 297: Standards for mechanical building systems specifying physical dimensions of hardware in both metric and inch. Describes a.o. 19” and 10” material.

IEC 794-2: Standard specifying versions of fiber optic cables.

IEC 874-1: Standard specifying measurement methods for fiber optic connections and connectors.

EN 55022 en EN 50082-1: EMC "legislation" specifically addressing immunity of data processing equipment against disturbances from inside and outside.

Cat 5^E/Class D^E applications features transmission capacity of 125 Mb/sec across a link of 90m, in accordance with the ISO/IEC max. length without counting patch-cables. In order to make these applications work without problems, the cabling built for these purposes is measured up to frequencies of 150-350 MHz. Although measurement systems will reach these frequencies, limit value however stops at 100 MHz.

As mentioned before, there is a growing demand for transmission-capacity. Data traffic between companies, but also to the outside world, within the actual telecommunication part of the infrastructure is growing rapidly. In LAN's, a string growth of VoIP (Ethernet) but also WiFi (wireless access points). In MAN/WAN – new techniques of Internet. LAN, MAN and WAN traffic will be more and more interlinked, not in the least because of internet traffic. This is why both data- as well as telecommunication have their own demands on the electronic highway. Ethernet exists from 1 up to 10 Gigabit.

How to use these protocols? Special codes may provide some help however at the end also bandwidth will have to be enlarged. And this in turn will demand adjustment of components, connectors and cable in order to meet these stronger requirements. For instance, IEEE802 is very clearly setting specific profiles in the data communication (equipment). Specifications are also more clearly defined using the requirements of various media in use for transmission.

Standards for structured cable will therefore be further developed: existing criteria will be upgraded, new classes and categories for higher frequency ranges will be introduced to which higher requirements will be made or which may lead to new measurement criteria. For instance enlargement of the Powersum- and Alien Crosstalk measurements.

Cat 5^E (provided correct installation) will enable 1 Gigabit Ethernet across 100m distance by allowing data traffic of 250 Mb per pair across all four pairs of classic unshielded or shielded cable.

Cat 6/6^A, class E and class E^A (250/350 MHz) is applied more and more, not only for standard data but also for various IP equipment applications.

To make this work well, a number of new issues need to be taken into account. The fact that all pairs are able to transmit signals in 2 directions increases the chance that they will have a negative influence between them. But to successfully transmit data at these

higher frequencies it must remain possible to distinguish data and noise. Designers of active equipment have anticipated to this fact.

Limit-values of various parameters have been defined more strictly. Higher demands are made to attenuation and reflection measurement and corresponding dispersion. Also cross-talk attenuation, NEXT, must be better because only then the ACR value may offer more margins in relation with the limits. Also, cross-talk should not just be defined at the near side, but also at the far end: FEXT.

And what is more: because all the pairs can interfere with each other, it is necessary to add the disturbance factor of the individual pairs to each other to determine the disturbance for another pair. For example, the PowerSUM next measurement, indicates the total for each pair of crosstalk as a result of the three other pairs. Also PowerSUM FEXT, ELFEXT and ACR will be determined in this way. In connection with alien cross talk, you may need to change to shielded category 6/6a, class E/EA cabling of 1 to 10 gigabits. 10 Gigabit applications require special quality in connection with a stable distance between the pairs (for example, spline or in the cable) and monitoring alien crosstalk (= the crosstalk of the surrounding cables to each other). Bundling of cables together can be very bad, because this can encourage the crosstalk. This has encouraged manufacturers to develop various forms of bundling.

Return loss also has a major impact on the transmission quality at high data rates. In connection with the return loss requirements for a good transmission with little reflection-loss caused by signal disturbances, the connection and the patch cable each play a very important role. One more reason with these stringent specifications to insist upon channel link measurements. The higher the frequency, the more vulnerable will be the data-stream for points of disturbance.

What is also included is the following: If the information related to a particular protocol is distributed over a number of pairs which individually contain a part, these signal-parts should not arrive at different times. The duration mismatch needs to be limited. This is identified by 'delay skew'. The large variations in twisting of pairs can be of influence. In category 6 (6^A), class e (E^A) this has already been optimized.

When certifying cabling infrastructure all of the specific aspects of the parameters will be included.

In category 7, class F (and in the future category 7^A, class 1 000 MHz) one deals with 600 MHz channel width and its applications, where only shielded cable can be used, per pair, and on all together. The use of the entire 600 MHz bandwidth of the cable and each pair of them will require high craftsmanship.

In these classes also additional high demands on quality and completion of the shielding will be made. To achieve this, Cenelec has introduced an additional parameter: the so-called 'coupling

attenuation' of a cabling installation must be able to demonstrate how the relationship between the value of an external disturbance signal and the remainder which will still be picked up in the cable itself.

Only if this value will be limited, there may be a specific guarantee given that the signal-noise ratio in signal cable data transmission at 600 megahertz (MHz) still allows.

Internal noise can be absorbed by the application of electronic filtering techniques. This is impossible for external noise, because appearance, size, frequency, and cause are unpredictable. So the cable has to play a role in this equation.

Fiber has been applied since long as the default in the backbone. It is now also increasingly applied in the LAN environment. 62.5/125 micron Multimode fibers (OM1) are being replaced by 50/125 micron Multimode fibers, which have the standard indication OM2 and OM3. For Single mode this standard is called S1 and S2.

Finally, we address VoIP: voice over Ethernet, where there is a possibility to feed the equipment through the 230 Volt adapter. However, the most desirable and common is usually the 'power inline' construction. The Ethernet switch supplies on a to be selected pair or combination of pairs the DC power supply for the phones. Problem for longer connections (> 55 metres) may be the concurrency. Bad patch- and connection cables are also a source of failures. In the early days the power in the switch for this power supply was relatively low, with new developments in the switches there is a tendency for higher power and this is recorded in the standards.

Note: Power over Ethernet (PoE) for larger networks demands extra engineering due to the energy delivered in the cables if these are too much bundled. Bundles of over 20 cables can already trigger this problem.

Annex:

Different types of applications can be described on the basis of functional attributes such as the logical structure (topology) and the access mechanism (Protocol). This approach is based on the active (electronics) hardware side, and this stems from the OSI model, drawn up by international standardization organization (ISO).

OSI stands for open systems interconnection, the model which is the basis of each network-design.

The OSI model proposes seven functional layers and the transition between the layers, which appear in any network, each playing their role and are inextricably linked with the bottom- and top layers

Each layer has a series of fixed services (services to and from the adjacent layers) according to a series of established agreements (Protocol).

The main layers are (layers in-between have not been taken into account):

1. physical layer
2. datalink layer
3. network layer
4. transport layer
5. session layer
6. presentation layer
7. application layer

Layer 4 through 7 are called user-oriented. Layer 1 through 3 are network-orientated. Cabling and components are associated with Layer 1. The definition of different networks on the basis of Protocol and topology will take place on layers 1 and 2. These definitions are further described in separate IEEE standards, such as IEEE 802.3 for Ethernet.

OVERVIEW OF REQUIRED PAIRS FOR VARIOUS APPLICATIONS

WIRING DIAGRAM

Pin	Colour	Function
1		-
2		-
3	Orange	R1
4	Blue	T1
5	Red	T2
6	White	R2
7		-
8		-

T = transmit R = receive

The colour is based on Quad standard 88 cable

Connection outlet S-bus: with feed-through boxes and termination
Max. 7 connections. Max. length 130

To connect ISDN, often UTP cat 5 or cat 5^E is used. Always use the wiring diagram specified by the equipment-manufacturer.

PIN WIRING

Pair	T568B	10B-T/100B-TX	1G/10G	T568A
1	5 4	1 2	5 4	5 4
2	1 2	3 6	1 2	3 6
3	3 6		3 6	1 2
4	7 8		7 8	7 8

RECEPTACLE FRONT VIEW

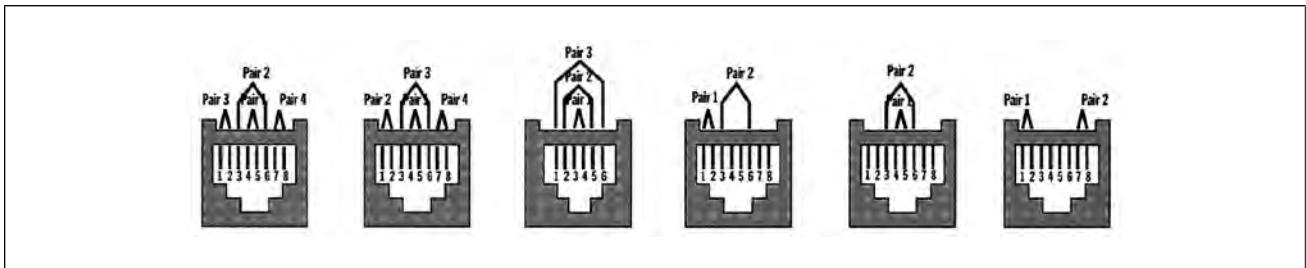

RECEPTACLE UPPER VIEW

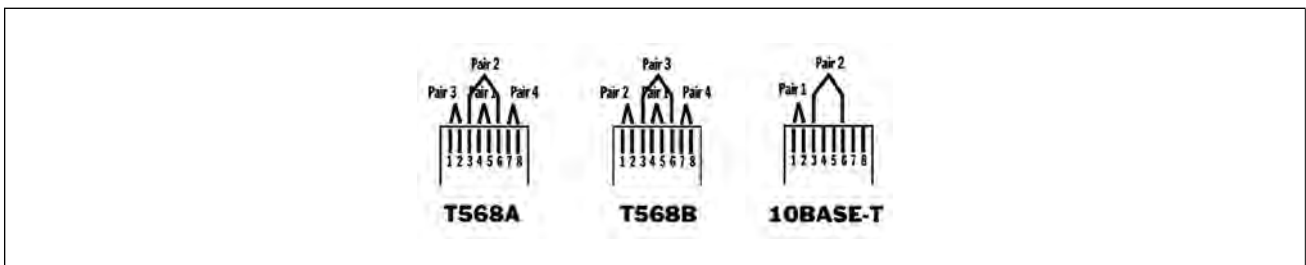

MOUNTING INSTRUCTIONS MODULAR PLUGS AND CONNECTORS

Wiring Diagram Twisted Pair Crossover cable

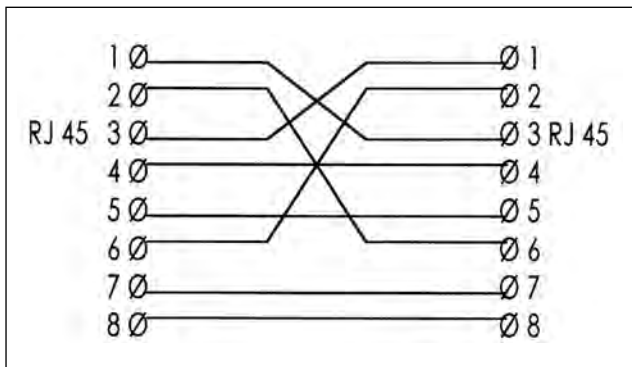

Final assembly cat. 5^E RJ45 plug

Strip the cable using cable stripping-tool R299550000 to a length of about 2 cm.

Arrange the cores from left to right, locking lip facing down:

For:	EIA-T568 A	EIA-T568 B
Pin 1	White – Green	Orange – White
Pin 2	Green	Orange
Pin 3	White – Orange	White – Green
Pin 4	Blue	Blue
Pin 5	White – Blue	White – Blue
Pin 6	Orange	Green
Pin 7	White – Brown	White – Brown
Pin 8	Brown	Brown

Cut new cores on length of 1.3 cm. Push core to end of connector and crimp using tool R280MOD395

Installation of RJ45 keystone jack, unshielded, cat 5^E & 6, 110 IDC technique (R280MOD807 and R280MOD803A)

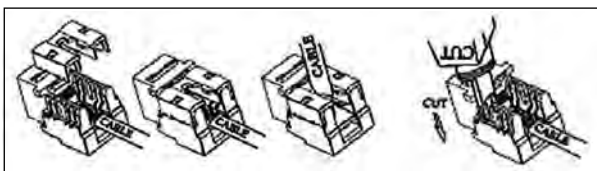

Wiring Diagram:

Colourcoding	EIA –T568 B
Wit – Blue	5
Blue	4
Wit – Orange	1
Orange	2
Wit – Green	3
Green	6
Wit – Brown	7
Brown	8

Note:

In order to determine the transmission speed as stated in the cat 5^E and cat. 6 standards, there is no need to de-twist the pairs. Half a rotation of the cores around each other is allowed.

Cat. 6 Jacks: preferably use punch down tool R280MOD404. The setting of this tool should be on H (high impact). In order to achieve a good assembly, we recommend that using the two-way punch-down knife, the side without cutting knife is used. The cores can then be pressed deeper into the contacts. During punching, move the punch-down tool "right to left" (back and forth) before pressing the cores home definitely. To remove the excess wire end, please use a wire-cutting tool. An additional security (which certification necessitates) is provided by the hood which can be pressed home.

Tip: press the hood home using a press down tool. It is recommended to use the Knipex (art.nr. 8603-180).

Installation of RJ45 keystone jack, unshielded, cat. 6, rapid mounting mode (R280MOD800)

1



Strip approximately 30mm of the cable jacket, and separate to 4 pair each.

2

2	1	6	3	A	B	T568A	T568B
■	▲	■	▲	■	▲	Pin 1 White/Green	Pin 1 White/Orange
■	▲	■	▲	■	▲	Pin 2 Green	Pin 2 Orange
■	▲	■	▲	■	▲	Pin 3 White/Orange	Pin 3 White/Green
■	▲	■	▲	■	▲	Pin 4 Blue	Pin 4 Blue
■	▲	■	▲	■	▲	Pin 5 White/Blue	Pin 5 White/Blue
■	▲	■	▲	■	▲	Pin 6 Orange	Pin 6 Green
■	▲	■	▲	■	▲	Pin 7 White/Brown	Pin 7 White/Brown
■	▲	■	▲	■	▲	Pin 8 Brown	Pin 8 Brown

Colored Sticker

3

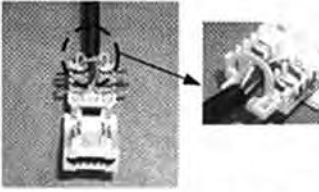

Follow the direction on the plastic lid color-coding to position T568A or T568B wiring, separate a little space on proper position and insert the wire pair by pair into each slot.

Unshielded type

4



Close the plastic lid by your thumb or tool to crimp and connect the wires.

5

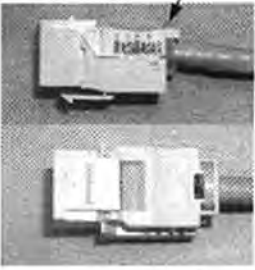

Complete the installation.



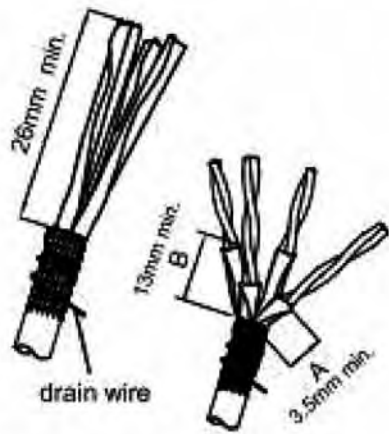

STEP 1:

Strip 26 mm of the jacket and fold braid to cover the jacket. Wrap the drain wire around the cable. The foil length of the wires passing through segment A are 3.5mm and those passing through segment B are 13mm (shown in Step 2)

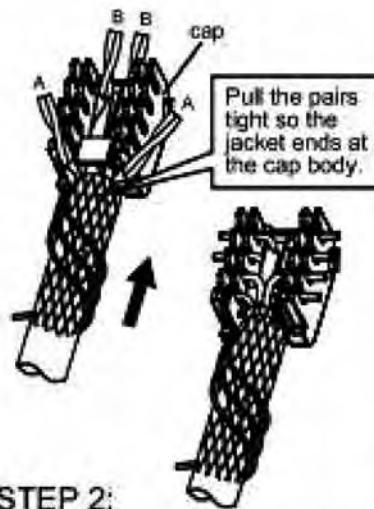

STEP 2:

Insert wire pairs into the correct positions (T568A/568B). Segment B pass through the tunnel and segment A is upper of segment B.

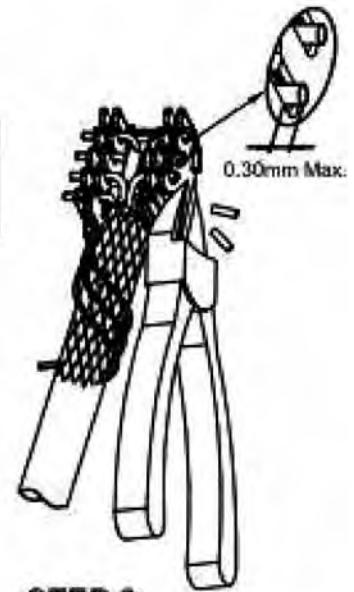

STEP 3:

The tips of the wires should be no more than 0.30mm.

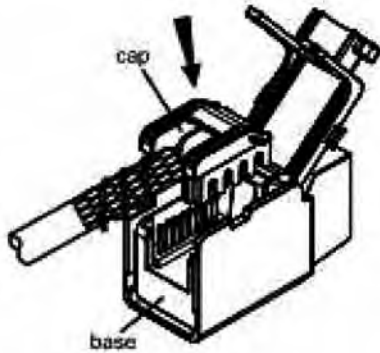

STEP 4:

Install cap on base. Be sure they snap together completely.

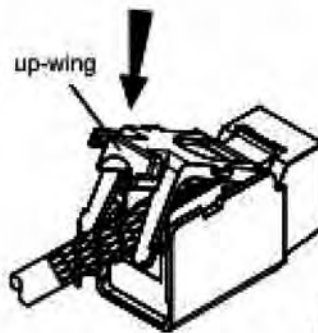

STEP 5:

Lock the up-wing on the base.

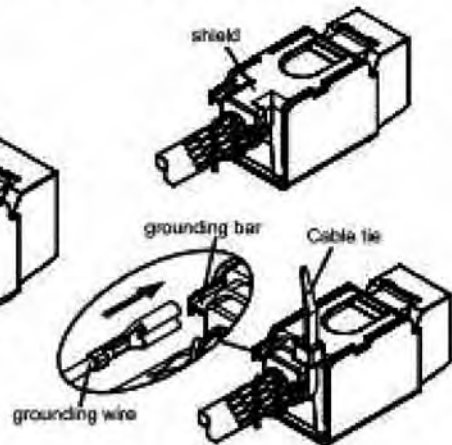

STEP 6:

Ensure the drain wire is wrapped around the cable. Tighten the cable with the shield by a wire tie.

Disassembly Instruction

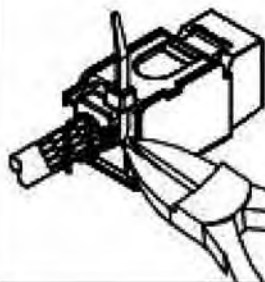

STEP 1:

Cut the tie wrap as close to the cable as possible. Do not cut the drain wire or damage.

STEP 2:

In order to remove the connector clip, insert a small screwdriver into the slot.

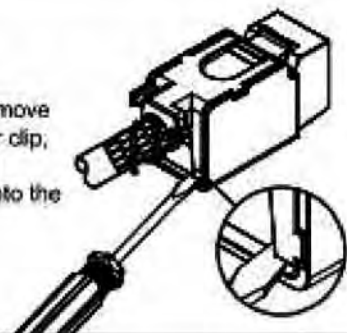

MOUNTING INSTRUCTIONS R280MOD830

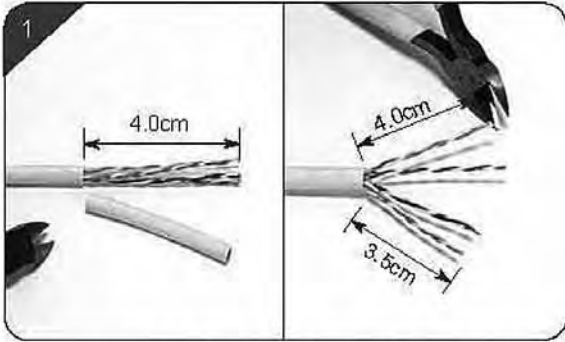

- Strip about 4.0cm of cable jacket, cut blue and green pairs 0.5cm shorter.

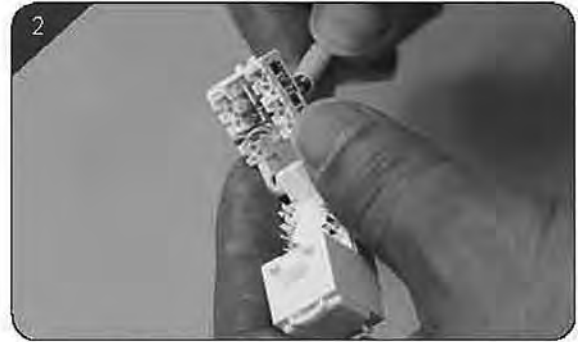

- According to color code, push down each untwisted pair through the cap hole all the way down.



- Place the cable-tie through cap ring, and cut the tail after tied up the cable.

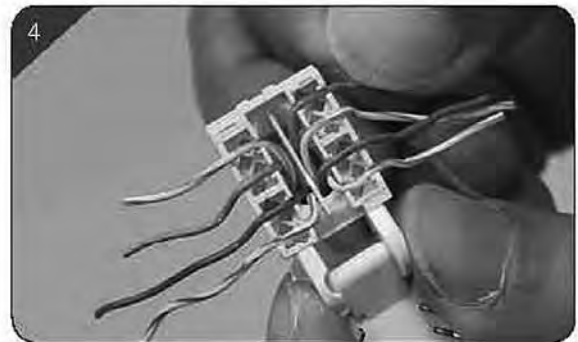

- Arrange the wires.



- Clamp down the wired cap onto the IDC to terminate all wires using your thumbs or using an optional clamping tool.



- Cut off redundant wires edgewise.



- Complete termination.

MOUNTING INSTRUCTIONS R280MOD831

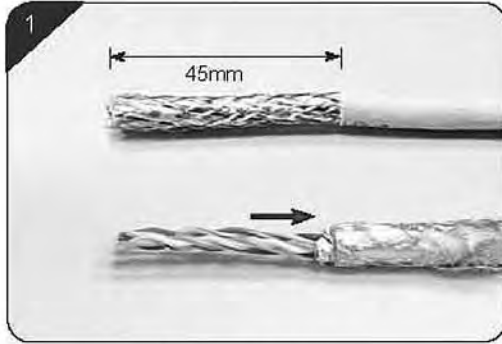

- Strip about 5.0cm of cable jacket. Roll back the copper braid when stripping the cable. Cut each pair's aluminum foil about 4.5cm.

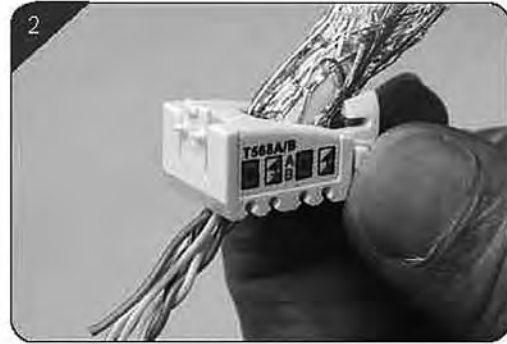

- According to color code, push each untwisted pair all the way down into the cap slots.

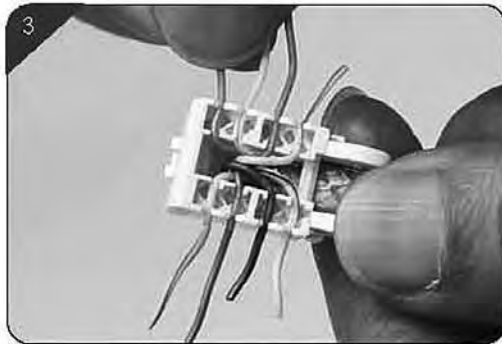

- Arrange the wires.

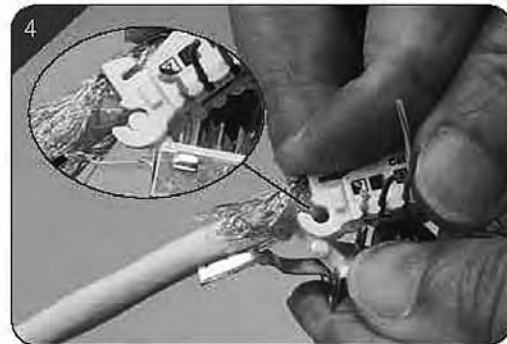

- Join the cap axis hole with the axis beam of the housing; the wired cap can rotate back and forth.



- Clamp down the wired cap onto the IDC to terminate all wires using just your thumbs or an optional clamping tool.

MOUNTING INSTRUCTIONS R280MOD831

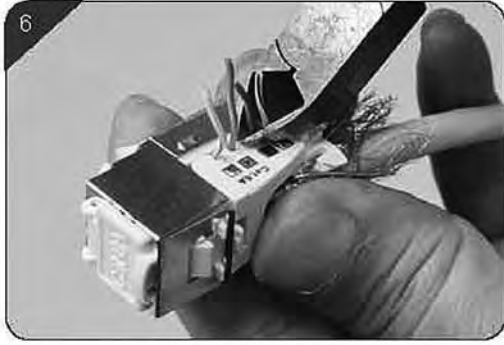

- Cut off redundant wires edgeways.



- Place the cable-tie through cap ring, and cut the tail after tied up the cable.

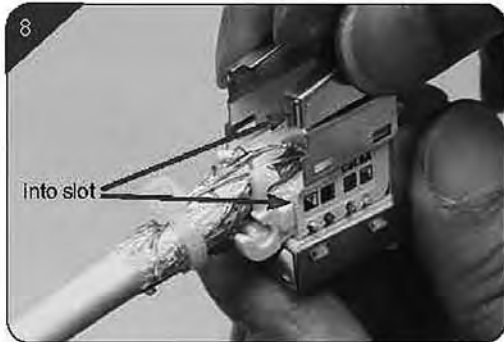

- Place shield guides into the wired-cap slot.



- Push to click shield knobs into the shield base.

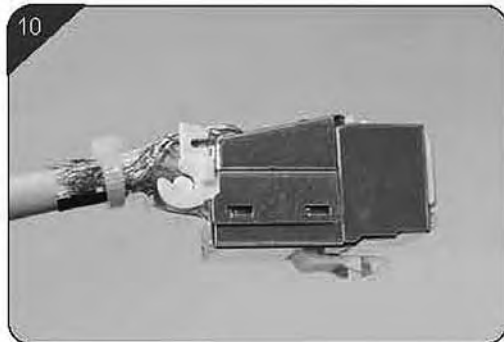

- Complete termination.

ASSEMBLY INSTRUCTIONS HDMI PLUG R396400026

1

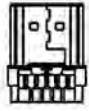

HDMI CONNECTOR

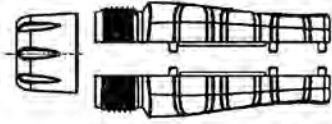

DIE CASTING

Die Cast cover upper & lower cover with screw ring (see step 1).

2

PIN ASSIGNMENT

P1		P2	P1	P2
3	White	3	13	Red
1	Brown	1	14	Pink
2	Drain	2	15	Gray
6	White	6	16	White
4	Green	4	17	Yellow
5	Drain	5	18	Orange
9	White	9	19	Purple
7	Red	7	shell	Weaving
8	Drain	8	shell	shell
12	White	12		
10	Blue	10		
11	Drain	11		

HDMI CABLE



Solder all conductors in accordance to pin assignment (see step 2).

3

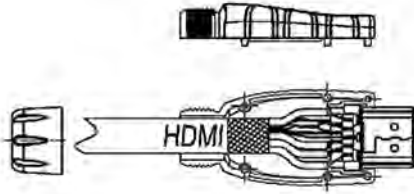

After soldering the HDMI connector, do not forget to double check if the wiring connection is correct, then place cover (see step 3).

4

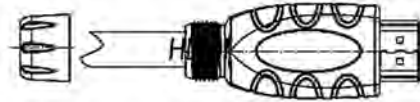

Fix the upper and lower cover and screw together (see step 4).

5

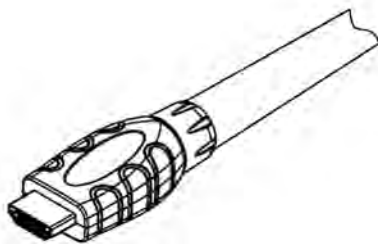

Finish.

Crimp type

1. Make sure that all connector piece parts are ready for use.
2. First slide the protector sleeve and then the ferrule onto the cable.
3. Strip the cable and the insulator according to the stripping instructions. Stripping dimensions can be found printed on the packing, within the product catalog or this booklet
4. Insert the cable core into the centre contact; in case of multiple stranded cable, first join all strands together;
5. Crimp the centre contact with the crimping tool by applying pressure on the crimping tool until the tool opens automatically
6. Carefully fan out the braid by turning the stripped cable around
7. Slide the cable into the body until it hits the insulator
8. Slide the ferrule across the braid until it hits the connector.
9. Crimp the ferrule with the crimping tool by applying pressure on the crimping tool until the tool opens automatically
10. Check if the crimp ferrule is firmly fixed and can not turn around the cable; if so, crimp the ferrule again at a little further distance from the connector. If this fails, cut off the connector and replace it.
11. After correct installation, slide the sleeve over the ferrule and heat shrink it in place (if applicable)

Clamp type / solder type

1. Make sure that all connector piece parts are ready for use.
2. Strip the cable and the insulator according to the stripping instructions. Stripping dimensions can be found printed on the packing, within the product catalog or this booklet
3. Slide nut, O-ring (if applicable), gasket or insulator and clamp nut onto the cable
4. fold the jacket backwards across the clamp and cut it off equally
5. Strip the insulator according to the stripping instructions.
6. Insert the cable core into the centre contact; in case of multiple stranded cable, first join all strands together; Solder the cable inner conductor into the centre contact
7. slide the back nut across the clamp assembly
8. mount the gasket into the connector and firmly attach the sub-assembly into the connector body with a torque of approx. 450Ncm (or other value if specified)

PANEL CUT OUT

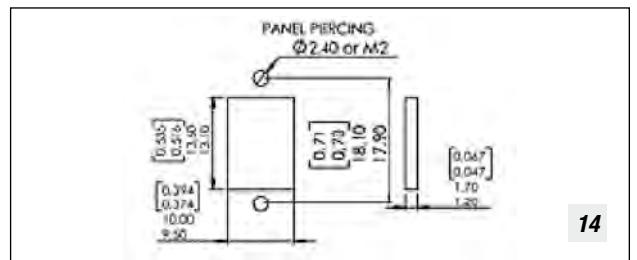
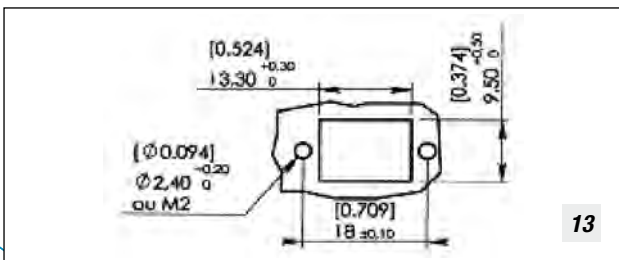
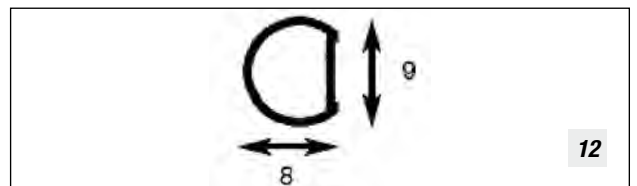
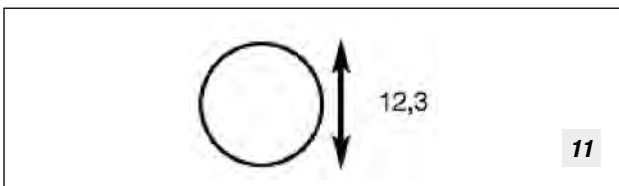
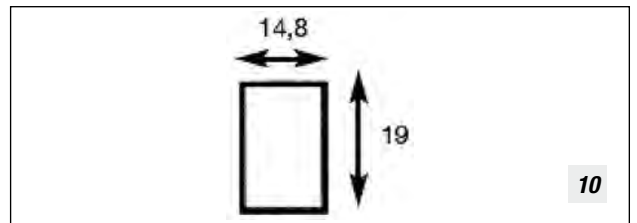
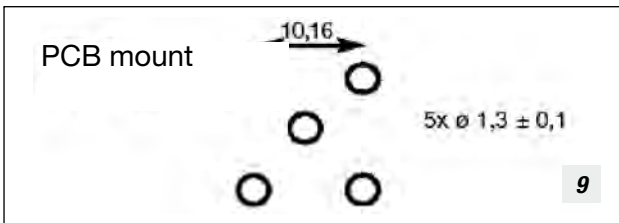
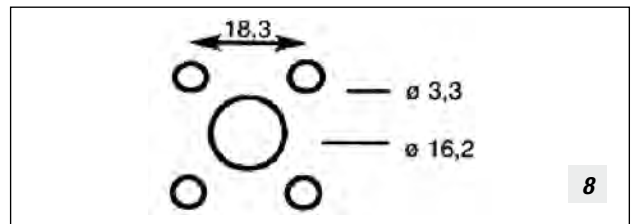
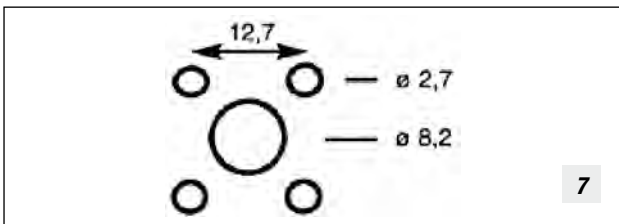
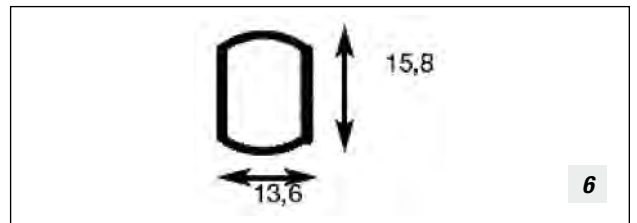
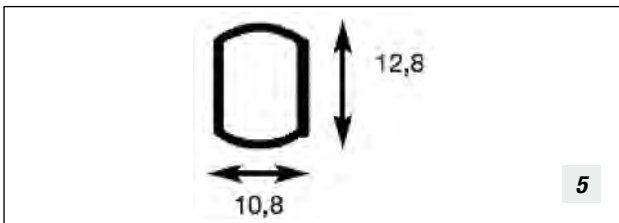
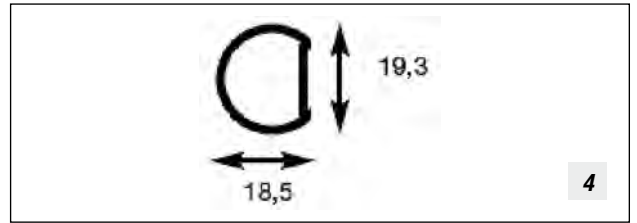
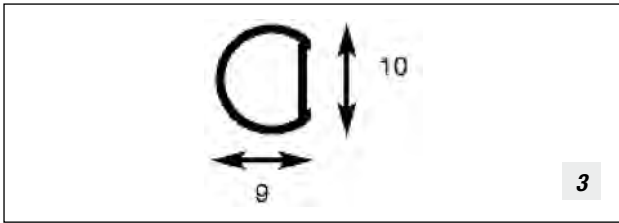
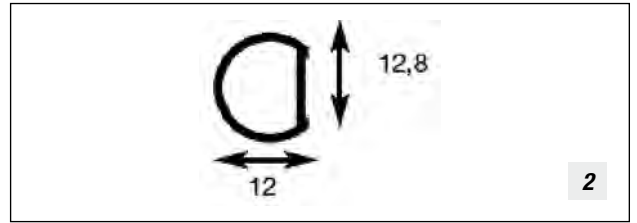
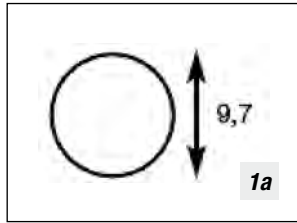
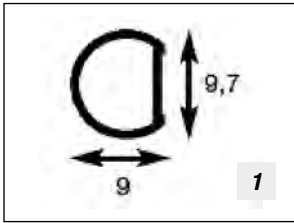

STRIPPING DIMENSIONS COAX CONNECTORS

STANDARD COAX SERIES

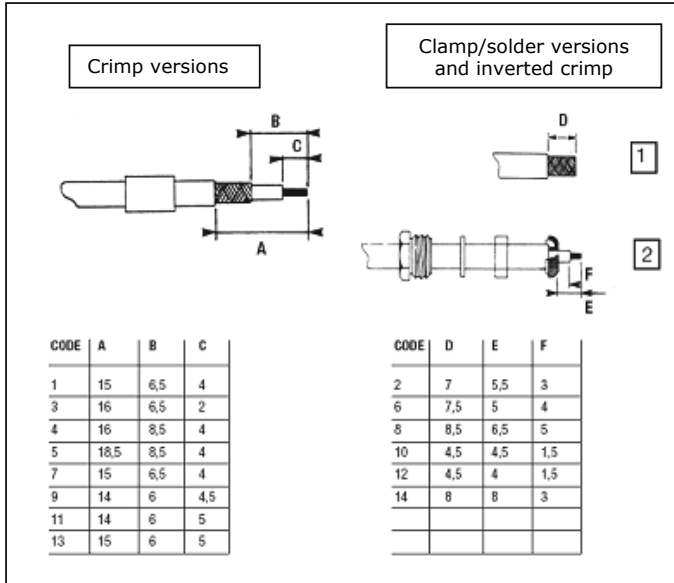

ECO SERIES

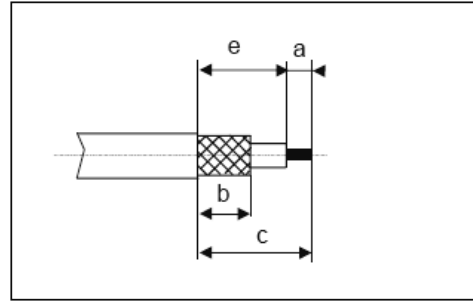

BNC ECO:	A	B	C	D	E	F
R141A075161	3,00	8,00	11,50	0,00	8,50	0,00
R141A082161	2,50	8,50	16,50	0,00	14,00	0,00
R141A306000	5,00	8,00	16,50	0,00	11,50	0,00
R141A332161	5,00	8,50	19,00	0,00	14,00	0,00
R142A076161	4,00	6,80	13,00	0,00	9,00	0,00
R142A085161	2,50	8,50	14,50	0,00	12,00	0,00
R142A306500	3,00	9,00	0,00	0,00	5,00	1,00
R142A334161	4,80	8,00	17,50	0,00	12,70	0,00

BNC:	Code:
R141007161	2
R141007161W	2
R141082161	1
R141082161W	1
R141082500	1
R141182000W	1
R141182161	3
R141182161W	3
R141237161	1
R141237161W	1
R141332161	1
R141332161W	1
R142016161	2
R142161161W	2
R142085161	1
R142085161W	1
R142184000	1
R142184161	3
R142184161W	3
R142242161	1
R142242161W	1
R142090000	1
R142334161	1
R142334161W	1

TNC:	Code:
R143075161W	5
R143082000W	1
R143082161	1
R143082161W	1
R143083161	1
R143156000	2
R143181161	3
R143181161W	3
R143182161	3
R143182161W	3
R143235161	1
R143331161	1
R143331161W	1
R143332161	1
R143332161W	1
R144085000	1
R144085161	1
R144085161W	1
R144334161	1
R144334161W	1

TNC:	Code:
R143007161	2
R143075161	5

N:	Code:
R161008000W	6
R161020000W	8
R16102200W	8
R161075000W	11
R161076000W	13
R161082000W	9

N ECO					
R161A082000	4,50	9,50	15,50	0,00	11,00
R161A083000	4,00	8,50	16,00	0,00	12,00
R161A075000	5,00	8,00	14,00	0,00	9,00
R161A088000	5,80	10,00	16,80	0,00	11,00
R161A182000	3,50	7,00	18,00	0,00	14,50
R161A183000	2,00	8,50	19,50	0,00	17,50
R161A184000	5,00	8,00	21,00	0,00	16,00
R161A186000	3,50	10,00	21,00	0,00	17,50

DIN 1.6/5.6 ECO					
R129A010215	10,70	12,00	0,00	0,00	1,00
R129A074000	2,50	8,00	12,00	0,00	9,50
R129A083000	3,00	8,00	12,50	0,00	9,50
R129A160215	4,50	7,00	0,00	0,00	2,30
R129A184000	4,50	7,00	13,50	0,00	9,00
R129A347000	4,00	8,00	15,00	0,00	10,00

DIN 1.0/2.3 ECO					
R118A074215	3,00	6,50	11,50	0,00	8,50
R120A074215	2,50	5,40	10,00	0,00	7,50
R118A311215	3,00	6,50	12,50	0,00	9,50
R120A311215	3,00	6,50	12,50	0,00	9,50

7/16 ECO					
R185A010000	5,50	7,50	0,00	0,00	0~0,2
R185A160000	4,80	16,10	0,00	0,00	8,80
R185A174000	3,80	10,00	26,40	0,00	22,60
R185A310000	5,50	7,50	0,00	0,00	0,20

A global range

To meet your needs



ANTENNAS

RADIALL develops and produces antennas for frequencies from 27 MHz to 6 GHz.

- Technologies used: wire, patch, printed, wire-plate, PIFA
- Numerous types of antennas: single pole, dipole, network, passive or active (with LNA), adaptable and intelligent, outdoor or integrated.



MICROWAVE COMPONENTS

Wide range of coaxial terminations and attenuators using standard interfaces (SMA, QMA, N, QN...) from low (1W) to high power (100W) and new cable load solution, chip terminations up to 18 GHz, hybrid or directional SMT couplers up to connectorized couplers, lightning protectors, detectors, rotary joints, phase shifters, DC Blocks...



AEP CONNECTORS

AEP, a Radiall US subsidiary, design RF connectors for the demanding requirements of military field radio and avionics systems:

- Coaxial waterproof connectors with a unique system of sealing.
- MIL-PRF-39012 QPL connectors
- SSMB and SSMC superior connectors
- SLB Self Aligning connector system.



MULTIPIN CONNECTORS

The range includes rack and panel connectors (Arinc 404 & MIL-C-81659B DSX, Arinc 600 NSX & SW280WS1 BPX, EN3682/MIL-C-83527 MPX JN1123 TCX), modular connector (EPX A & B), compatible with a large variety of contacts : signal, power, RF, data bus, fiber optic, quadax and twinax.

A range of wire to wire and wire to board is also available: B & MCSR duty connectors, M, MM, MB, MBC rectangular miniature series, MMC.



FIBER OPTIC CONNECTORS

Wide range of interconnect solutions, including standard connector interfaces for multimode and singlemode fiber (LC, SC, FC, ST...) as well as connectors and terminations (MIL-T-29504, ARINC 801) for harsh environment applications (aeronautic, military, naval, medical, railway...). Great flexibility for custom design.



MICROWAVE SUB-SYSTEMS

We design Filters, Duplexers, Splitters and Combiners, Switching matrix, interconnection racks and enclosures, Custom assemblies, ...

Our expertise includes Microwave passive systems design, Mechanical integration to customer environment, Thermal management, Cabling, wiring, harnessing, ...



HARNESSES

The combination of design and manufacturing of RF and microwave cables as well as multipin connectors (EPX, ARINC 404 and 600) allows Radiall to be a specialist of harnesses for on-board (aeronautic, navy...) or land (railways, removed antenna...) equipment or communications systems. All types of contacts can be used and mixed such as signal, power, RF, quadax, fiber optic...



RF & MICROWAVE CABLE ASSEMBLIES

RG, Eco-Friendly, Handformable, Semi-rigid, SHF Ultra-low loss (General Interconnect, Outdoor, Airframe phase matching large choice of interfaces, Lightweight), ...



RF & MICROWAVE SWITCHES

Wide range of coaxial switching products for commercial, military and instrumentation applications. Available with a large choice of interfaces (SMA, QMA, N, ...), from DC to 40 GHz.

Main products:

- Standard RAMSES series.
- PLATINUM series with high repeatability (0.03dB) on insertion loss during 10 million actuations.
- Subminiature SPnT up to 26.5 GHz.
- SMT high power micro-SPDT.



RF COAXIAL CONNECTORS

The widest range of coaxial connectors in the world from microminiature (UMP) to standard connectors (7/16) covering the frequency range of DC to 65 GHz mixing standardized and custom interfaces (UMP, IMP, MMS, MMT, QMA, QN, MMBX).



AEROSPACE



Automotive



DEFENSE



INDUSTRIAL



INFRASTRUCTURE



MEDICAL



SPACE



TELECOM

EUROPE

France - RADIALL Headquarters

101, Rue Ph. Hoffmann
93116 ROSNY-sous BOIS (Paris)
Tel.: +33 1 49 35 35 35 - Fax: +33 1 48 54 63 63
E-Mail: info@radiall.com

Finland - RADIALL SF

P.O. Box 262 - 00101 DULLI
Tel.: +358 407 522 412
E-Mail: infofi@radiall.com

Germany - RADIALL GmbH

Carl-Zeiss-Str. 10 Postfach 200143
D63307 - RÖDERMARK (Frankfurt)
Tel.: +49 60 74 91 07 0 - Fax: +49 60 74 91 07 70
E-Mail: info@radiall.com

Italy - RADIALL Elettronica S.R.L.

Via Concordia, 5 - 20090 ASSAGO MILANO
Tel.: +39 02 48 85 121 - Fax: +39 02 48 84 30 18
E-Mail: infoit@radiall.com
Regional office: Roma

Netherlands - RADIALL B.V.

Hogebrinkerweg 15b - 3871 KM HDEVELAKEN
Tel.: +31 33 253 40 09 - Fax: +31 33 253 45 12
E-Mail: info@radiall.com

Sweden - RADIALL A.B.

Sjöängsvägen 2 - SE-192 72 SOLLENTUNA (Stockholm)
Tel.: +46 844 434 10 - Fax: +46 875 449 16
E-Mail: info@radiall.com

U.K. - RADIALL Ltd

Ground Floor, 6 The Grand Union Office Park,
Packet Boat Lane
UXBRIDGE Middlesex UB8 2GH (London)
Tel.: +44 1895 425 000 - Fax: +44 1895 425 010
E-Mail: info@radiall.com

NORTH AMERICA

USA - RADIALL USA, Inc.

6825 West Galveston Street Suite 11
CHANDLER, Arizona 85226
Tel.: +1 480 682 9400 - Fax: +1 480 682 9403
E-Mail: info@radiall.com

USA - RADIALL AEP, Inc.

104 John W. Murphy Drive
NEW HAVEN, Connecticut 06513
Tel.: +1 203 776 2813 - Fax: +1 203 776 8294
E-Mail: ae@radiall.com

ASIA

China - SHANGHAI RADIALL Electronic Co., Ltd

N° 390 Yang He Road 200072 - SHANGHAI
Tel.: +86 21 66 52 37 88 - Fax: +86 21 66 52 11 77
E-Mail: info@radiall.com

Japan - NIHON RADIALL

Shibuya-ku Ebisu 1-5-2, Kougeitsu Bldg 405
TOKYO 150-0013
Tel.: +81 3 3440 6241 - Fax: +81 3 3440 6242
E-Mail: info@radiall.com

HongKong - RADIALL Electronics Ltd

Elite Industrial Centre, Room 212, 2/F
N° 883 Cheung Sha Wan Road
KOWLOON HONG KONG
Tel.: +852 29 59 38 33 - Fax: +852 29 59 26 36
E-Mail: infohk@radiall.com

India - RADIALL PROTECTRON pvt Ltd

25 D, II Phase, Peenya Industrial Area
BANGALORE 560058
Tel.: +91 80 83 95 271 - Fax: +91 80 83 97 228
E-Mail: info@radiall.com

ALSO REPRESENTED IN

Australia	Hungary	Poland
Austria	Indonesia	Russia
Belgium	Israel	Singapore
Brazil	Korea	Spain
Czech Republic	Latvia	Switzerland
Denmark	Lithuania	Taiwan
Estonia	Malaysia	Thailand
Greece	Norway	Vietnam
	Philippines	South Africa

For the above countries, please contact the local agent or RADIALL at info@radiall.com

