2SA872, 2SA872A

Silicon PNP Epitaxial

HITACHI

ADE-208-1001 (Z)
1st. Edition
Mar. 2001

Application

- Low frequency low noise amplifier
- Complementary pair with 2SC1775/A

Outline

TO-92 (1)

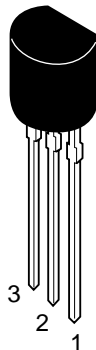

1. Emitter
2. Collector
3. Base

2SA872, 2SA872A

Absolute Maximum Ratings (Ta = 25°C)

Item	Symbol	2SA872	2SA872A	Unit
Collector to base voltage	V_{CBO}	-90	-120	V
Collector to emitter voltage	V_{CEO}	-90	-120	V
Emitter to base voltage	V_{EBO}	-5	-5	V
Collector current	I_C	-50	-50	mA
Collector power dissipation	P_C	300	300	mW
Junction temperature	T_j	150	150	°C
Storage temperature	T_{stg}	-55 to +150	-50 to +150	°C

Electrical Characteristics (Ta = 25°C)

Item	Symbol	2SA872			2SA872A			Unit	Test conditions
		Min	Typ	Max	Min	Typ	Max		
Collector to emitter breakdown voltage	$V_{(BR)CEO}$	-90	—	—	-120	—	—	V	$I_C = -1 \text{ mA}$, $R_{BE} = \infty$
Collector cutoff current	I_{CBO}	—	—	-0.5	—	—	—	μA	$V_{CB} = -75 \text{ V}$, $I_E = 0$
		—	—	—	—	—	-0.5	μA	$V_{CE} = -100 \text{ V}$, $I_E = 0$
DC current transfer ratio	h_{FE1}^{*1}	250	—	800	250	—	800		$V_{CE} = -12 \text{ V}$, $I_C = -2 \text{ mA}$
	h_{FE2}	160	—	—	160	—	—		$V_{CE} = -12 \text{ V}$, $I_C = -0.1 \text{ mA}$
Base to emitter voltage	V_{BE}	—	—	-0.75	—	—	-0.75	V	$V_{CE} = -12 \text{ V}$, $I_C = -2 \text{ mA}$
Collector to emitter saturation voltage	$V_{CE(sat)}$	—	—	-0.5	—	—	-0.5	V	$I_C = -10 \text{ mA}$, $I_B = -1 \text{ mA}$
Gain bandwidth product	f_T	—	120	—	—	120	—	MHz	$V_{CE} = -12 \text{ V}$, $I_C = -2 \text{ mA}$
Collector output capacitance	C_{ob}	—	1.8	—	—	1.8	—	pF	$V_{CB} = -25 \text{ V}$, $I_E = 0$, $f = 1 \text{ MHz}$
Noise figure	NF	—	—	5.0	—	—	5.0	dB	$V_{CE} = -6 \text{ V}$, $f = 10 \text{ Hz}$ $I_C = -50 \mu\text{A}$ $R_g = 50 \text{ k}\Omega$
		—	—	1.5	—	—	1.5	dB	$f = 1 \text{ kHz}$

Note: 1. The 2SA872/A is grouped by h_{FE1} as follows.

D	E
250 to 500	400 to 800

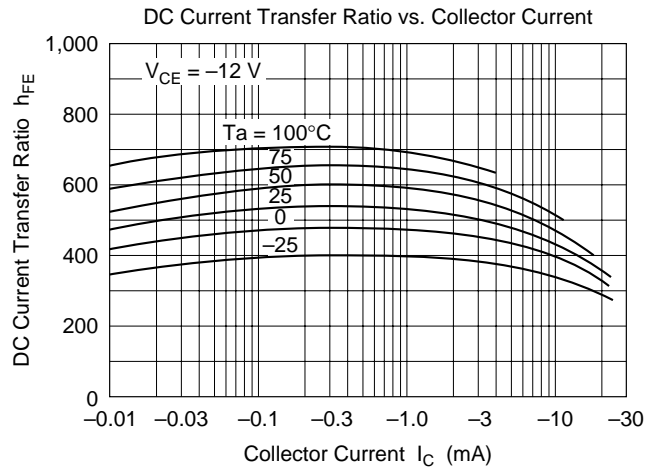
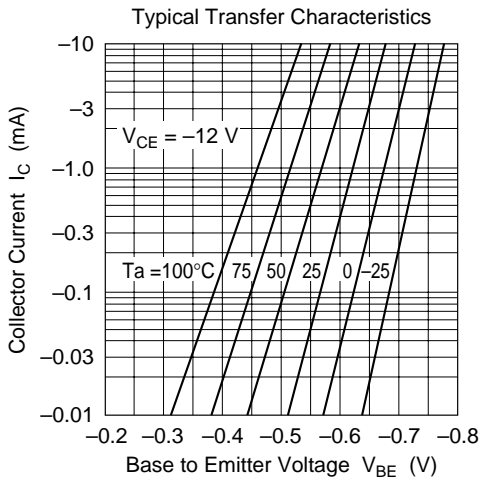
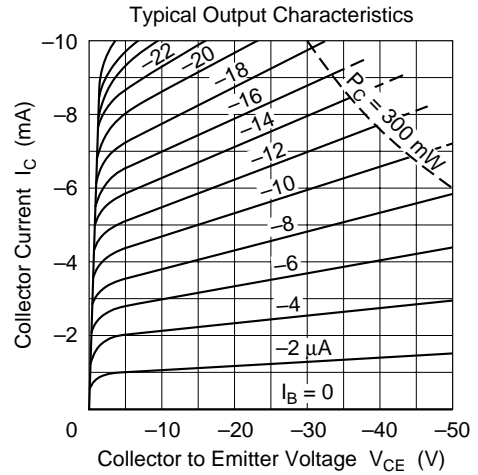
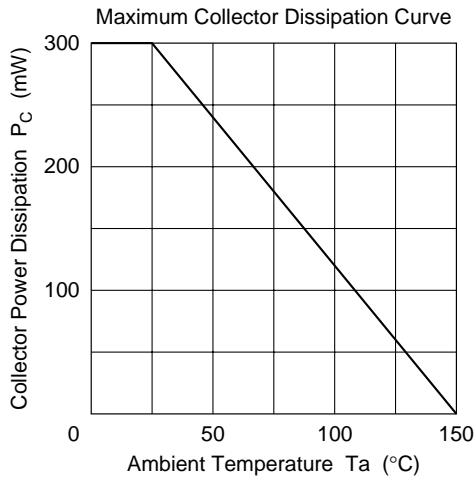

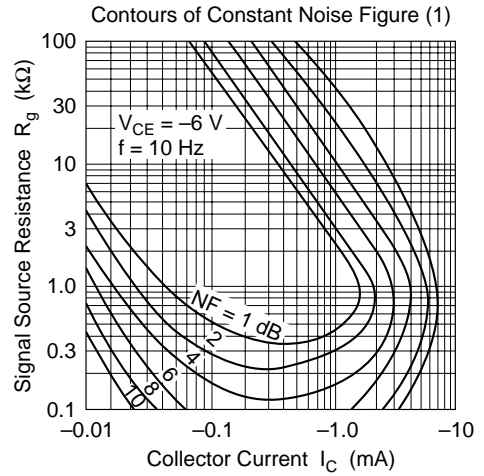
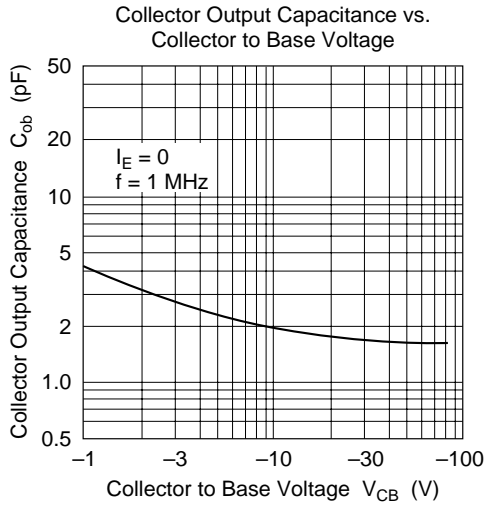
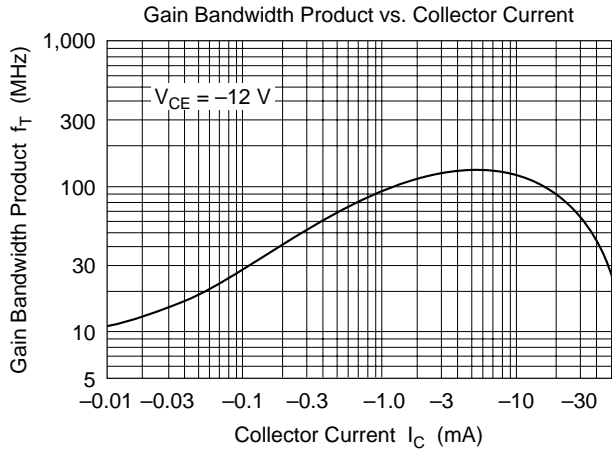

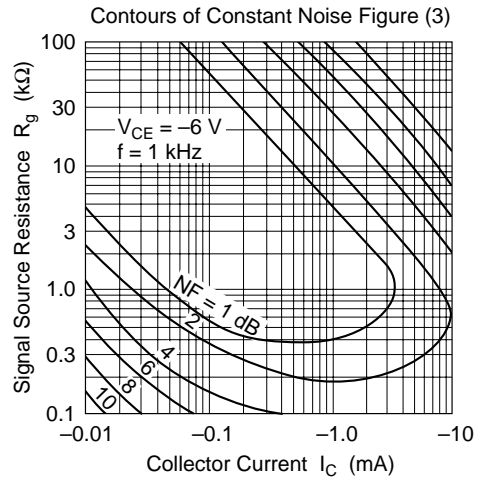
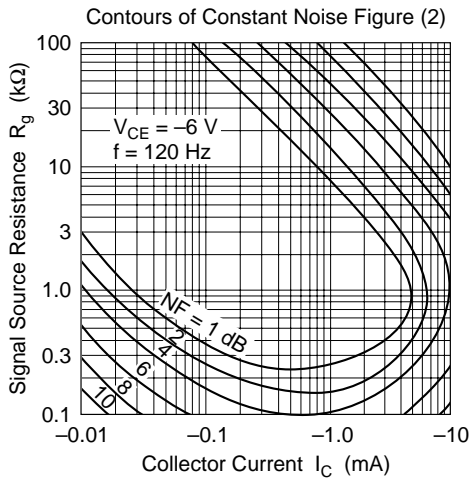

Package Dimensions

As of January, 2001
Unit: mm

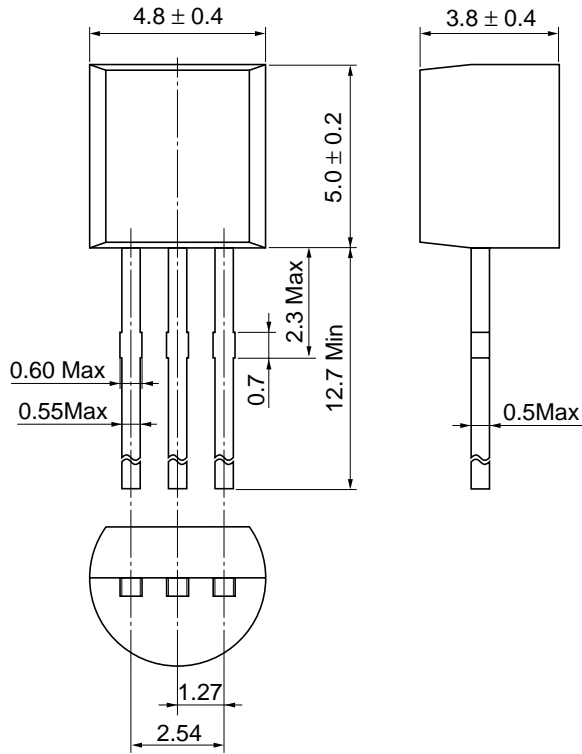

Hitachi Code	TO-92 (1)
JEDEC	Conforms
EIAJ	Conforms
Mass (reference value)	0.25 g