

»» Features



- High rating miniature PCB Relay.
- UL/CUL · CSA · VDE approved.
- Low power consumption 400mW coil.
- 20A 277VAC/SPDT, 10A 277VAC/DPDT & TV-8 ratings are approved.
- Low profile 15.7mm and high insulation system Class F.
- High CTI 250 material & New Glow Wire Approved. (E version)
- Comply with RoHS-Directive 2002/95/EC.

»» Type List

◆ Standard Type

Terminal style	Contact form	UL Insulation system approval	Designation (provided with)		
			Flux tight	Sealed type	Sealed type washable
PCB terminal	1A (SPNO)	-----	881-1AC-C	881-1AC-V	881-1AC-S
	1C (SPDT)	-----	881-1CC-C	881-1CC-V	881-1CC-S
	2A (DPNO)	-----	881-2AC-C	881-2AC-V	881-2AC-S
	2C (DPDT)	-----	881-2CC-C	881-2CC-V	881-2CC-S
	1A (SPNO)	F	881-1AC-F-C	881-1AC-F-V	881-1AC-F-S
	1C (SPDT)	F	881-1CC-F-C	881-1CC-F-V	881-1CC-F-S
	2A (DPNO)	F	881-2AC-F-C	881-2AC-F-V	881-2AC-F-S
	2C (DPDT)	F	881-2CC-F-C	881-2CC-F-V	881-2CC-F-S
	1A (SPNO)	-----	881-1AH-C	881-1AH-V	881-1AH-S
	1C (SPDT)	-----	881-1CH-C	881-1CH-V	881-1CH-S
	2A (DPNO)	-----	881-2AH-C	881-2AH-V	881-2AH-S
	2C (DPDT)	-----	881-2CH-C	881-2CH-V	881-2CH-S
	1A (SPNO)	F	881-1AH-F-C	881-1AH-F-V	881-1AH-F-S
	1C (SPDT)	F	881-1CH-F-C	881-1CH-F-V	881-1CH-F-S
	2A (DPNO)	F	881-2AH-F-C	881-2AH-F-V	881-2AH-F-S
	2C (DPDT)	F	881-2CH-F-C	881-2CH-F-V	881-2CH-F-S

Note : 881A—Special footprint 5.0mm pinning version can be selected

◆ High Power Type

PCB terminal	1A (SPNO)	-----	881H-1AC-C	881H-1AC-V	881H-1AC-S
	1C (SPDT)	-----	881H-1CC-C	881H-1CC-V	881H-1CC-S
	1A (SPNO)	F	881H-1AC-F-C	881H-1AC-F-V	881H-1AC-F-S
	1C (SPDT)	F	881H-1CC-F-C	881H-1CC-F-V	881H-1CC-F-S
	1A (SPNO)	-----	881H-1AH-C	881H-1AH-V	881H-1AH-S
	1C (SPDT)	-----	881H-1CH-C	881H-1CH-V	881H-1CH-S
	1A (SPNO)	F	881H-1AH-F-C	881H-1AH-F-V	881H-1AH-F-S
	1C (SPDT)	F	881H-1CH-F-C	881H-1CH-F-V	881H-1CH-F-S



Ordering Information

881 H - 1C H - F - C E
 1 2 3 4 5 6 7

- | | | | |
|----------|---|----------|-------------------------------|
| 1. 881 | -- Basic series designation | 4. C | -- Contact material AgNi |
| | | CA | -- Contact material AgNi + Au |
| 2. Blank | -- Standard type | H | -- Contact material AgSnO |
| | (1P - Terminal pitch 3.5mm) | HA | -- Contact material AgSnO+ Au |
| | (2P - Terminal pitch 5.0mm) | | |
| A | -- Standard type and special terminal pitch | 5. Blank | -- Standard type |
| | (1P - Terminal pitch 5.0mm) | F | -- Class F |
| H | -- High power type | | |
| | (1P - Terminal pitch 5.0mm only) | 6. C | -- Flux tight |
| | | V | -- Sealed type |
| 3. 1A | -- Single pole normally open | S | -- Sealed type washable |
| 1B | -- Single pole normally closed | | |
| 1C | -- Single pole double throw | 7. Blank | -- Standard type |
| 2A | -- Double pole normally open | E | -- CTI 250V |
| 2B | -- Double pole normally closed | | |
| 2C | -- Double pole double throw | | |

Contact Rating

Type	881 1A · 1C	881 2A · 2C	881H 1A · 1C
Rated load (resistive)	12A 240VAC	8A 240VAC	16A 240VAC
Max. switching current	12A	8A	16A
Max. switching voltage	277VAC	277VAC	277VAC
Max. switching capacity	2880VA	1920VA	3840VA

Coil Rating (DC)

Rated voltage (V)	Rated current ±10 % at 23°C (mA)	Coil resistance at 23°C (Ω)	Max. continuous voltage at 85°C	Pick up voltage(Max) at 23°C	Drop out voltage(Min) at 23°C	Power consumption at rated voltage
5	80	62 ±10%	150 % of rated voltage	70 % of rated voltage	10 % of rated voltage	approx. 0.4W
6	67	90 ±10%				
9	44	203 ±10%				
12	33	360 ±10%				
18	23	771 ±10%				
24	17	1440 ±10%				
36	11.1	3240 ±10%				
48	8.7	5520 ±10%				
60	8	7340 ±15%				
110	4	26600 ±15%				

»» Specification

Contact material	AgNi / AgSnO alloy	
Contact resistance ⁽¹⁾	100mΩ Max.	
Operate time ⁽¹⁾	20ms Max.	
Release time ⁽¹⁾	10ms Max.	
Insulation resistance ⁽¹⁾	1000MΩ Min. (DC 500V)	
Surge voltage withstand ⁽¹⁾	Between contact and coil : 10KV (1.2X50) μS	
Dielectric strength	Between open contact : AC 1000V, 50/60Hz 1 min.	
	Between contact and coil : AC 5000V, 50/60Hz 1 min.	
	Between contact circuits : AC 3000V, 50/60Hz 1 min. (for 2pole only)	
Vibration resistance	Operating extremes	10~55Hz , amplitude 1.5 mm
	Damage limits	10~55Hz , amplitude 1.5 mm
Shock resistance	Operating extremes	10G
	Damage limits	100G
Life expectancy	Mechanical	30,000,000 operations (frequency 72,000 operations /hr)
	Electrical	100,000 operations (frequency 360 operations /hr)
Operating ambient temperature	-40~+85°C (no freezing) ⁽²⁾	
Weight	Approx. 10 g	

Note : (1) initial value.

(2) special version of high temperature 105°C can be selected.

»» Safety Approval

Certified	UL / CUL	VDE	CSA
File No.	E88991	132905	1435530

»» Safety Approval Rating(UL/CUL、CSA)

881 1P (C · CA)		881 1P (H · HA)	
NO	NC	NO	NC
20A 277VAC 10FLA, 60LRA 250VAC 12A 30VDC 1HP 240/480VAC A300	20A 277VAC 10FLA, 60LRA 250VAC 12A 30VDC 1HP 240/480VAC	20A 277VAC 10FLA, 60LRA 250VAC 1HP 120/240/480VAC TV-8 A300	20A 277VAC 10FLA, 60LRA 250VAC 1HP 120/240/480VAC A300

881 2P (C · CA)		881 2P (H · HA)	
NO	NC	NO	NC
10A 277VAC 10A 30VDC 1/2HP 120/240VAC B300	10A 277VAC 10A 30VDC 1/3HP 120/240VAC B300	10A 277VAC 10A 30VDC 1/2HP 120/240VAC TV-5 B300	10A 277VAC 10A 30VDC 1/3HP 120/240VAC B300

»» Safety Approval Rating(VDE)

881 1A · 1C	881H 1A · 1C	881 2A · 2C
12A 250VAC T85	20A 250VAC T85 12A 250VAC T105	10A 250VAC T85

»» Outline Dimensions

◆ 881 1P

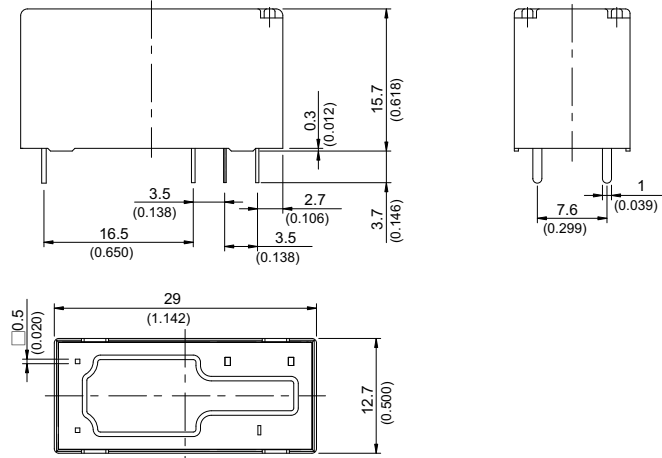

◆ 881 2P

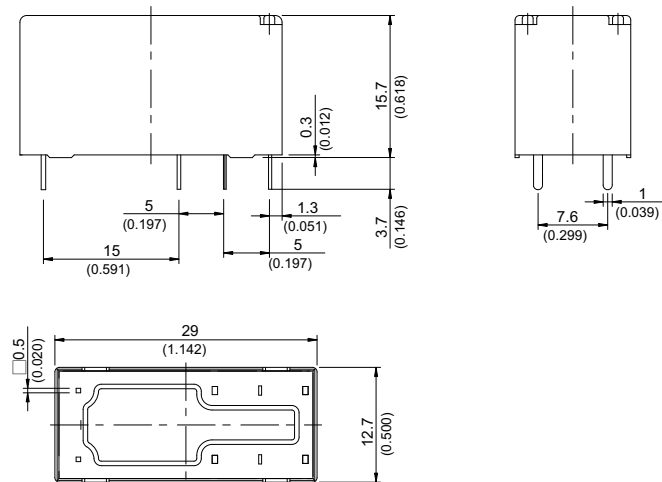

◆ 881H 1P

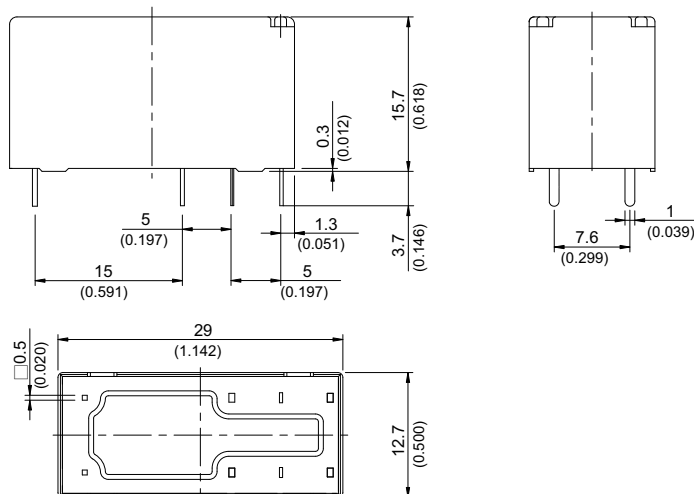

◆881A 1P

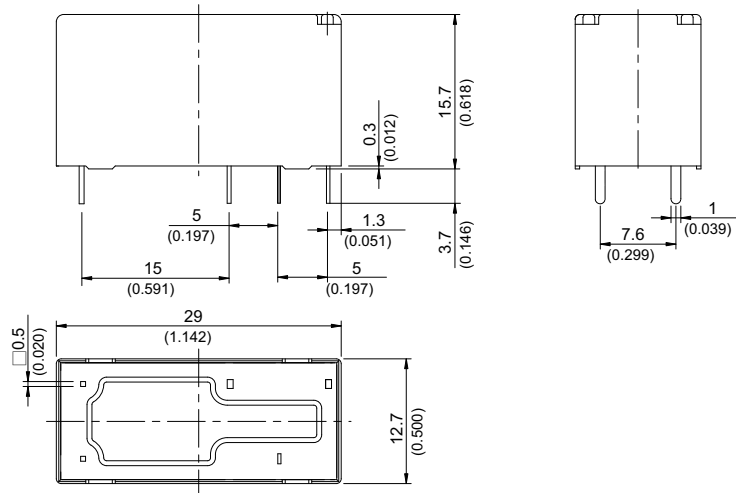

»» Wiring Diagram
BOTTOM VIEW

◆881

1C

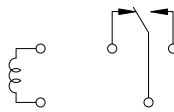

1A

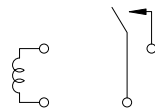

2C

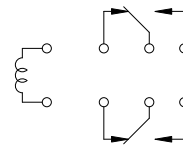

2A

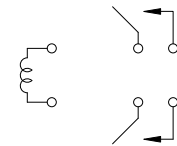

◆881H

1C

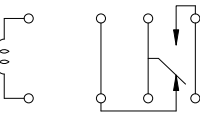

1A

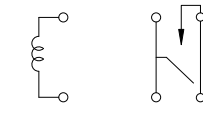

◆881A

1C

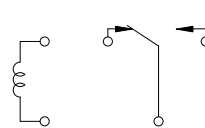

1A

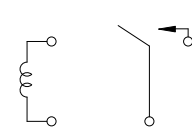

»» PC Board Layout
BOTTOM VIEW

◆881

1C

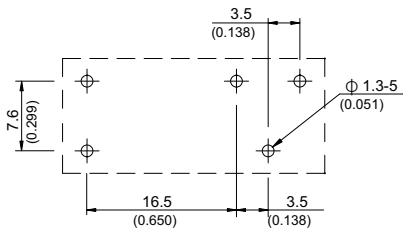

1A

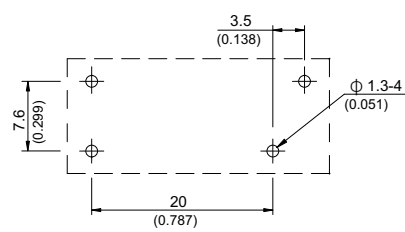

2C

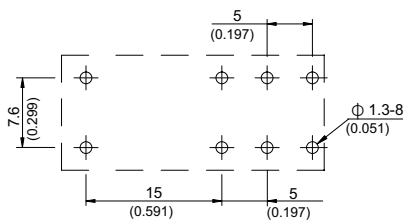

2A

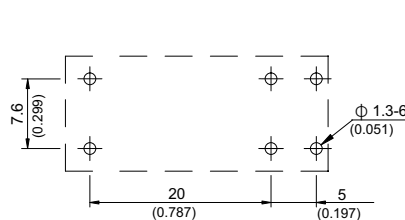

◆ 881H

1C

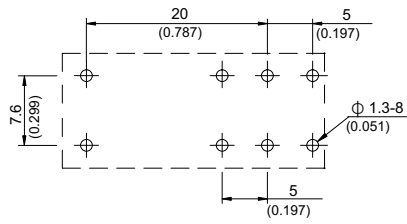

1A

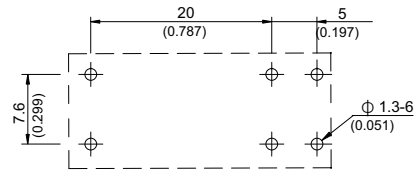

◆ 881A

1C

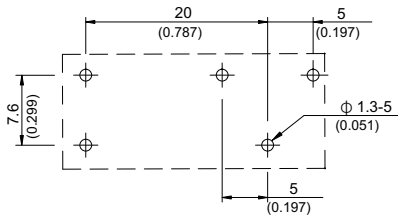

1A

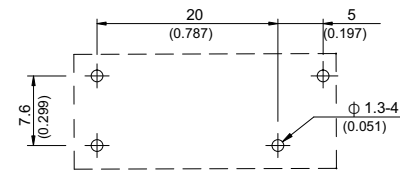

» Engineering Data

◆ 881(1P)

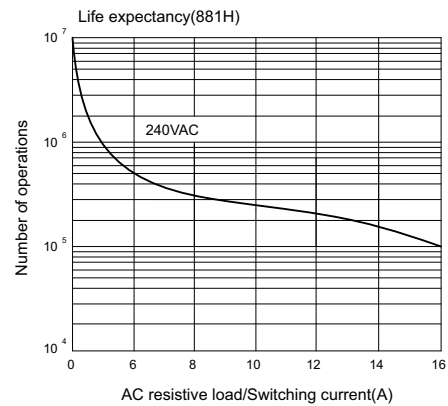
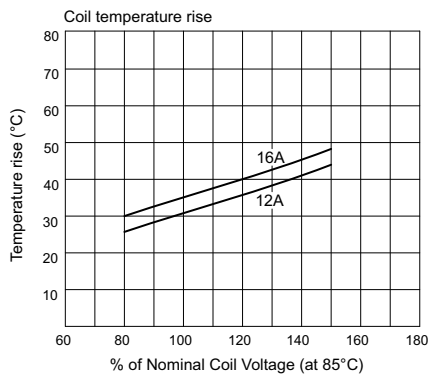
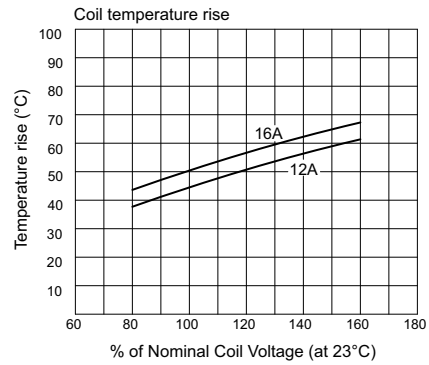
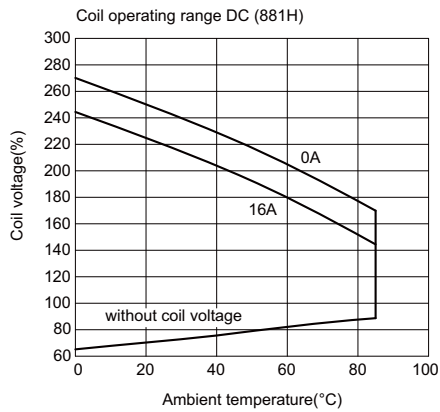

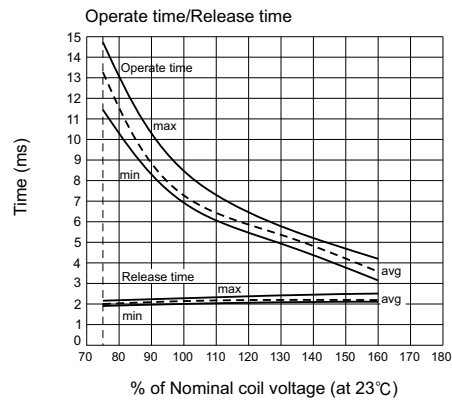
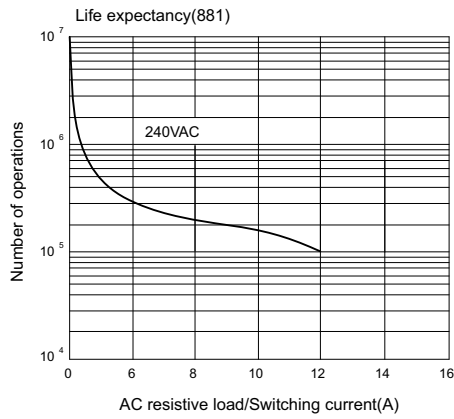

◆ 881(2P)

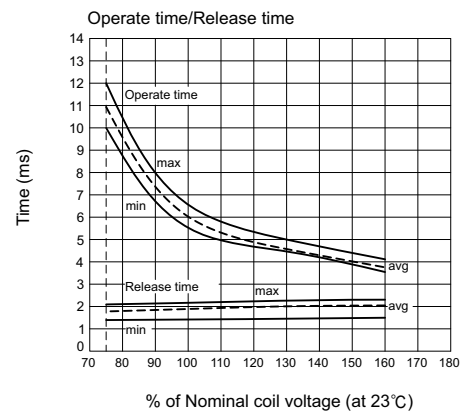
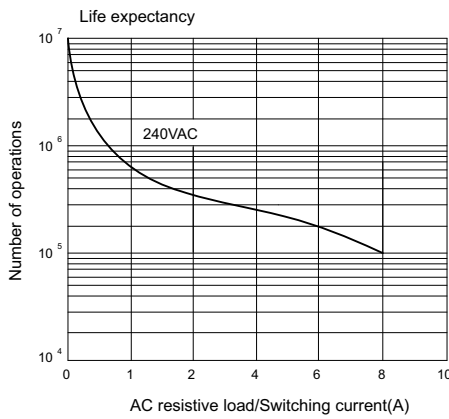
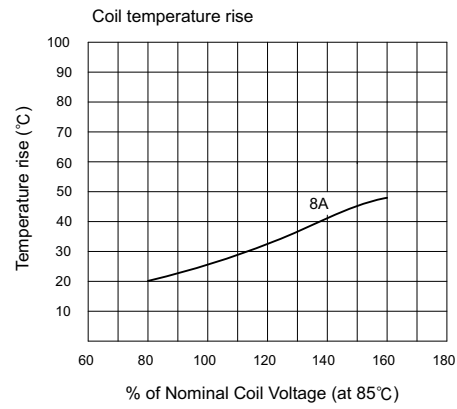
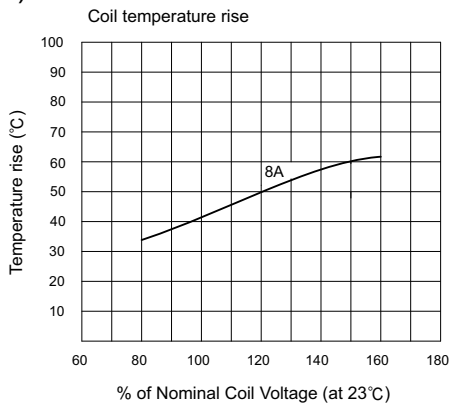

◆ 881/881H

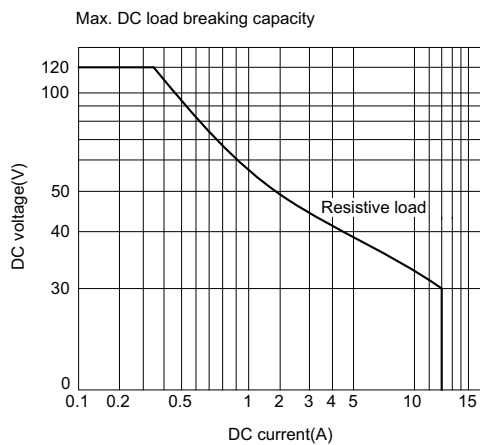

Mouser Electronics

Authorized Distributor

Click to View Pricing, Inventory, Delivery & Lifecycle Information:

Song Chuan:

[881WP1-1AC-F-S-12VDC](#) [881WP1-1AC-F-S-24VDC](#) [881-1CC-F-S-12VDC](#) [881H-1CC-F-S-24VDC](#) [881-1CC-F-S-24VDC](#) [881H-1CC-F-S-12VDC](#) [881WP2-1AC-F-S](#) [881H-1CH-F-S-12VDC](#) [881H-1CH-F-S-24VDC](#) [881-2CC-F-C-24VDC](#)